

T20

The Collection



TARGETTI

TARGETTI

index

01	Us Targetti	8
02	Indoor Collection	
	Recessed	80
	Projectors	220
	Systems	330
	Ceiling and suspensions	434
	Wall mounted luminaires	516
03	Outdoor Collection	
	Inground recessed	542
	Projectors	628
	Wall recessed luminaires	706
	Surface luminaires	726
	Bollards	760
04	Control sytem	780
05	Tecnical data	802

Indoor



Recessed

Linear recessed



82
LOGICO

Recessed



94
THREESIXTY

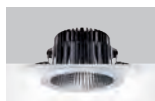

106
CCTLED
Smart-Tech-Feel



117
CCTLED
Deep



118
CCTLED
Wall Washer



124
CCTLED
Mini



124
CCTLED
Mini WW



126
CCTLED
Micro



128
CCT Flash



132
CCTLED Arch.
Fix



138
CCTLED Arch.
Adj



141
CCTLED Arch.
HP Adj



151
CCTLED Arch.
Mini fix



152
CCTLED Arch.
Mini adj



158
CCTLED Arch.
Micro



160
OZ
Stand alone

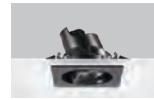

176
STORE



192
ZENO Small



196
CLOUD



208
COZY



210
BEBOP



212
QUICKLED



214
POLKA



218
OTTO
Semi Recessed



219
OTTO
Recessed



Projectors

Track projectors

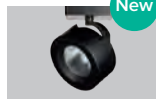

222
ZENO



236
LABEL 230V



242
STORE



254
LEDÒ



266
RAY



278
EUROSTANDARD
Plus

Surface projectors



284
JEDI
Compact

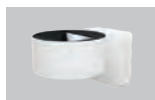

292
ZENO



296
VOLTA



302
CORO



324
OTTO
Base



328
OTTO
Multi - Optic



Systems

Systems
48V

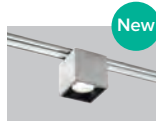

332
OZ

New

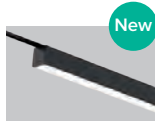

358
FORTYEIGHT

New

Systems
230V



376
LOGICO

New



Ceiling and Suspensions luminaires

Linear
Ceiling and
Suspensions
luminaires



436
ISO

New



442
OMEGA

New

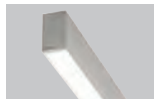

448
LOGICO



456
CARTESIO

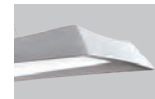

460
DIVA



464
SLIM

Ceiling and
Suspensions
luminaires



468
MINIMINIMA



470
OZ Sand alone

New



476
THREESIXTY



488
PANTHEON



494
CCTLED
Pendant



496
CCTLED
Tube



506
BEBOP



508
GLOBO



510
WASABI



512
DECANter



514
MONETA



Wall mounted luminaires

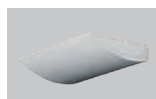

518
FLOOD



520
HALL

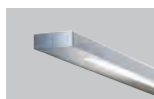

522
SLIM



524
MINIMINIMA



526
MONETA



528
BRAQUE



530
BOTTONE



532
OSIRIDE



538
PROFESSIONAL

Outdoor



Inground recessed

Linear
inground
recessed

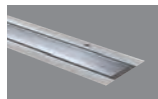

544
JEDI



556
JEDI Compact



570
MERCURE

Inground
recessed

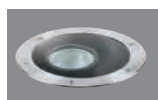

578
KEPLERO



593
KEPLERO MINI

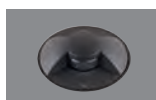

602
TITANO



604
JUPITER



614
SATURN

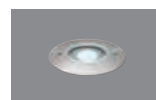

620
LED.Y

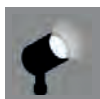

Projectors

Linear
projectors



630
JEDI



642
JEDI Compact

Projectors



656
DART



674
PYROS



688
JUPITER pro



699
JUPITER



702
LED.Y

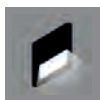

Wall recessed



708
ZEDGE PRO



719
ZEDGE Line



719
ZEDGE Line Opal



722
ZEDGE

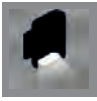

Surface luminaires



730
MR SMITH



737
MRS SMITH



740
FEBO EVO



728
Q-BO



746
STILO



758
HOCKEY



Bollards



762
MR. BO



768
CHIODINO



772
STILO



776
ZEDGE Bollard

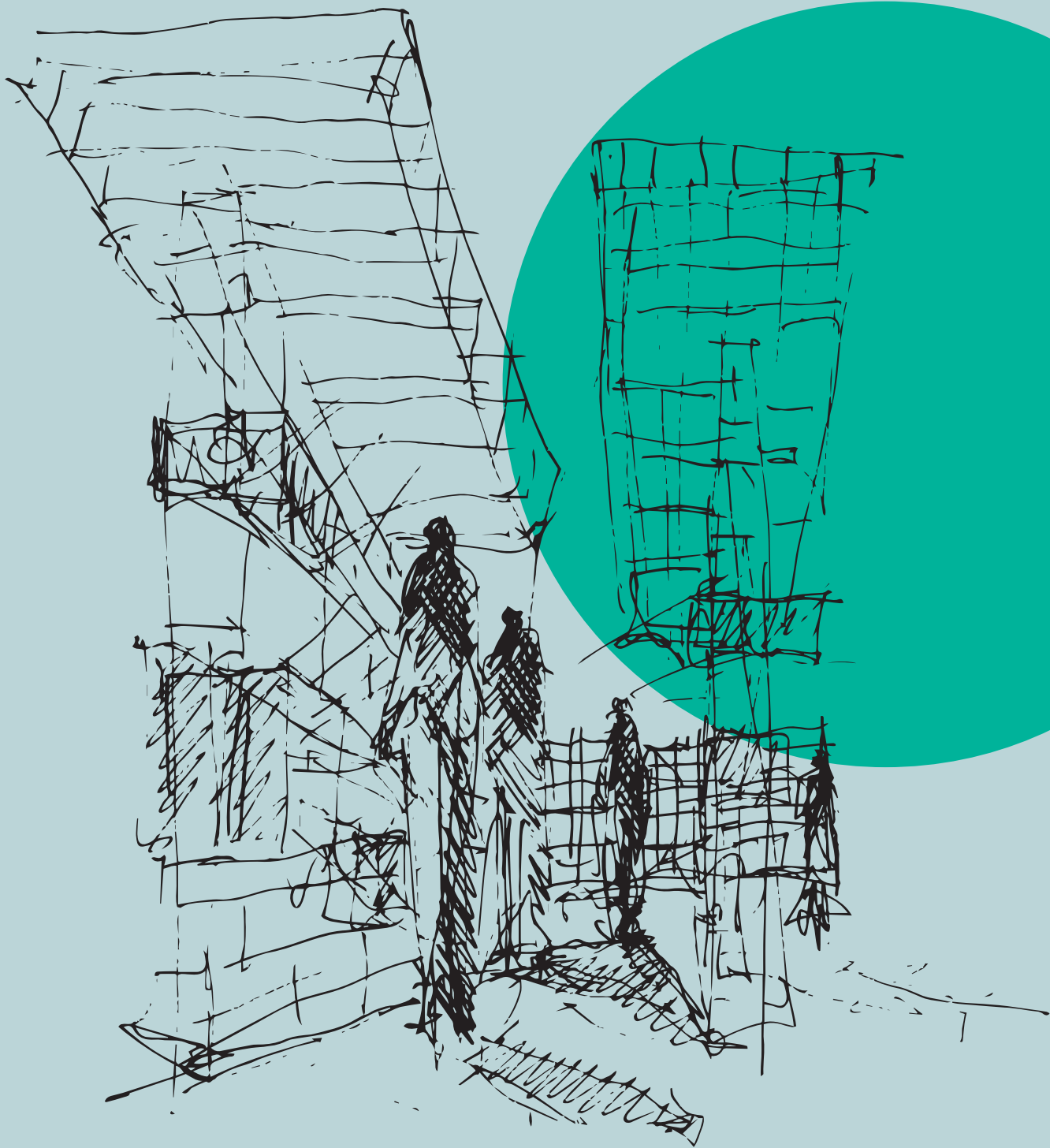

The Group

3F Filippi and Targetti, two companies that have shaped the history of lighting in Italy are now a cohesive Group acting as sole partner for lighting professionals and designers looking for quality solutions.

With extensive experience and the combination of their respective expertise in technical and architectural lighting the two brands together provide a complete portfolio of products that proudly bring Made in Italy to more than 50 countries worldwide.

Today the 3F Filippi-Targetti Group can meet and satisfy any kind of design and project requirements. Our partners can choose from a huge selection of products and solutions; from high-tech and functional products from the 3F Filippi catalogue to indoor and outdoor architectural lighting fixtures designed by Targetti, right up to a wide range of LED lamps and fixtures from the Duralamp brand.



We are Targetti

A workshop to light the world

**We started in 1928.
Since then we at Targetti
have never stopped
designing and creating
indoor and outdoor
architectural light fixtures.**

For almost a century our products, which are synonymous with innovation, research and attention to detail, have been lighting the most prestigious architectural and artistic works, creating extraordinary atmospheres and evoking real emotions.

Our appearance and identity today are the result of the experience and professionalism we have gained over time, which we want to share with our partners and put at the service of the quality of the environment we live in through our passion for light





Targetti Headquarters Florence
New Hub TH01 - 2018.

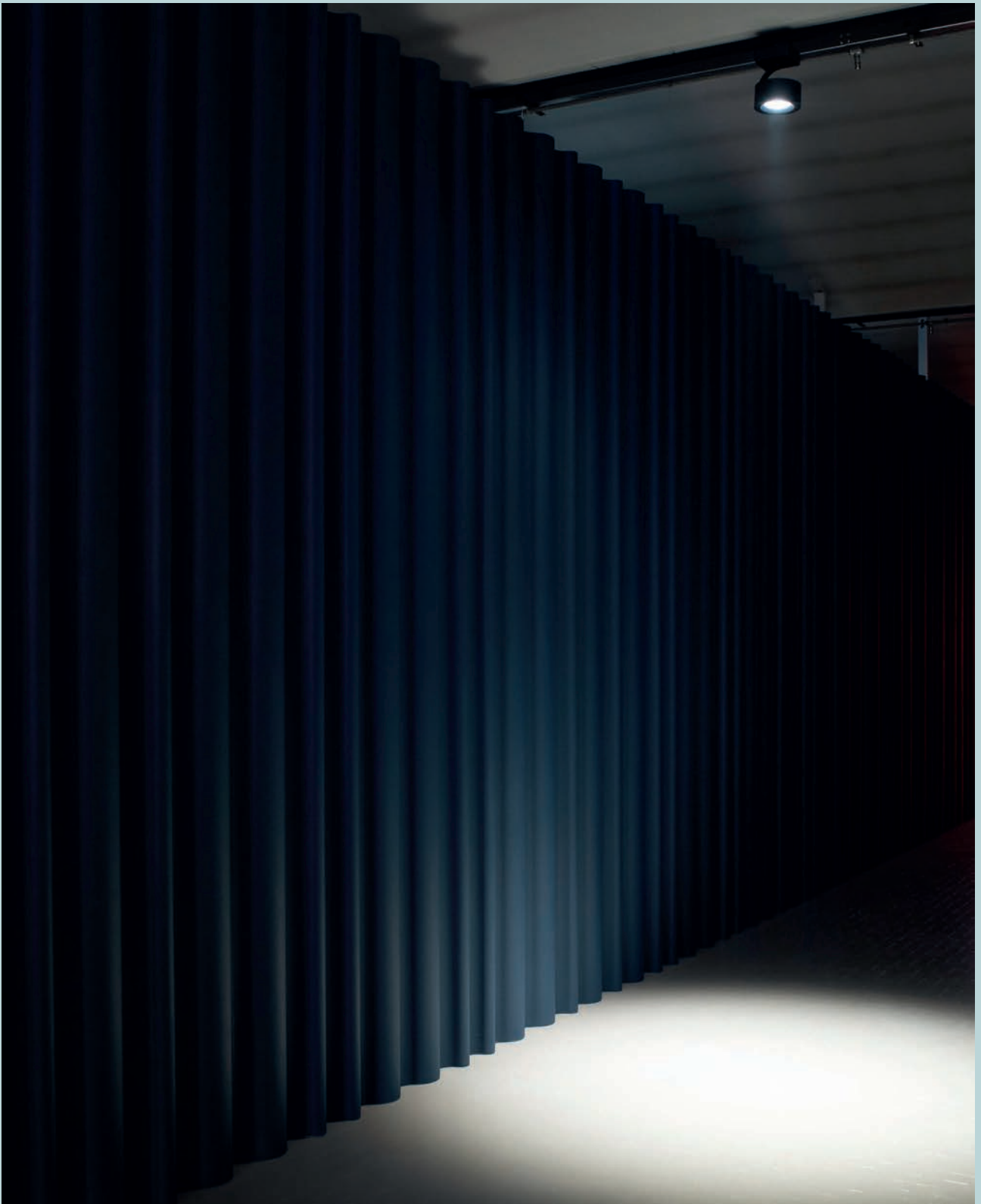

**Our
ideas**

Our essential vocabulary with the words we cannot do without

↘ **Light**

Light is our raw material, an essential tool and the focus of the work we do. An impalpable and magic element that designs shapes and animates spaces. To us its language is technical refinement, scientific precision as well as a feeling, an atmosphere and the possibility to dress a space up with emotions.





Intuition

Intuition as our main purpose, as an awareness that makes it possible to glimpse a direction for the future, as a spark of genius that continues to make us pioneers in defining new standards.

At left Infinitree - Lighting installation designed for Targetti by DPA Lighting UK Darc awards London, UK - 2018.

On this page Together
Lighting installation designed for Targetti by DPA Lighting UK Darc Awards London, UK - 2019







Dialogue



Photographer: Romainv

Listening, welcoming stimulus, sharing knowledge and experience. Dialogue is a mind that is open to outside influences, continual exchanges of ideas with partners, multidisciplinary attention and a heart that is always ready to take on new challenges.



Innovation

Three infinite concepts we are very fond of: progressing, evolving and changing. In a word innovation. The courage to lead the way with the passion and the amazed and curious perspective of someone who knows they still have a long way to go.









Design

Every single one of our products has always epitomised the essence of who we are: essential and discrete shapes and excellent performance in recognisable designs that are within everyone's reach. Beauty, functionality and simplicity.



Worldwide

Global presence and local networks: our partners can reach us easily. The solutions we provide are versatile and can meet the needs of designers from all corners of the world.

Legend

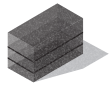

Production plan



Subsidiary



Employee



23



2

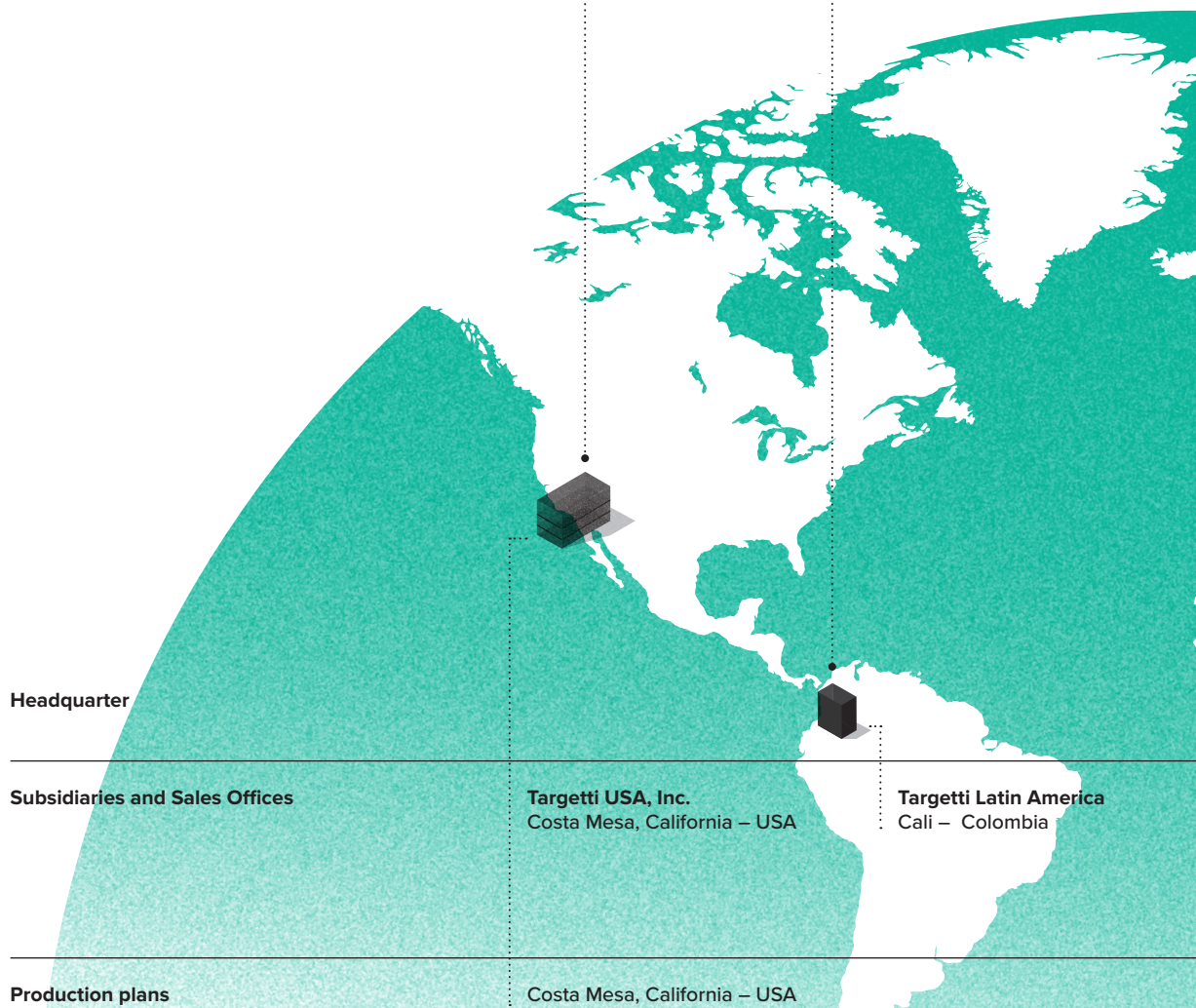

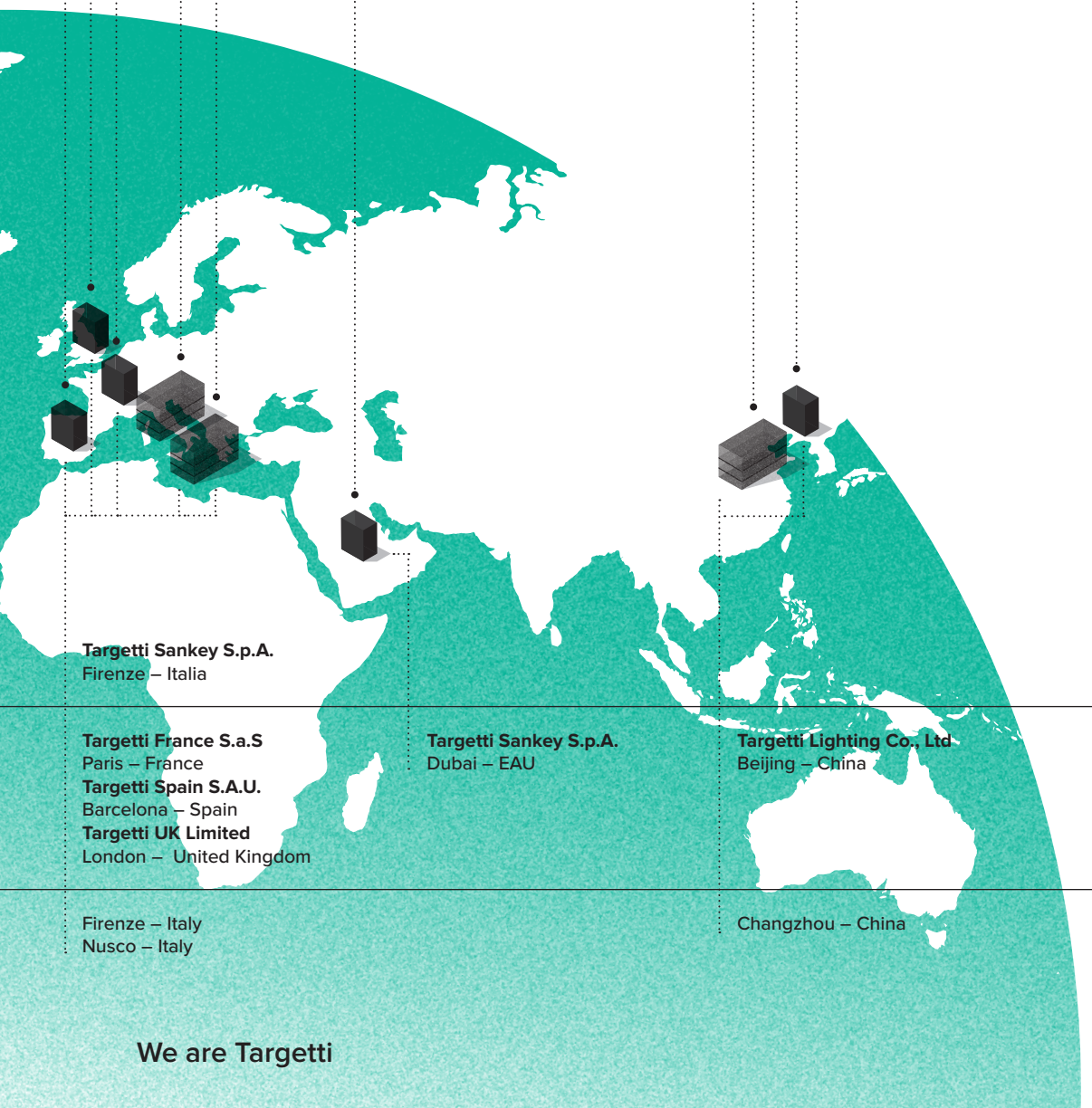
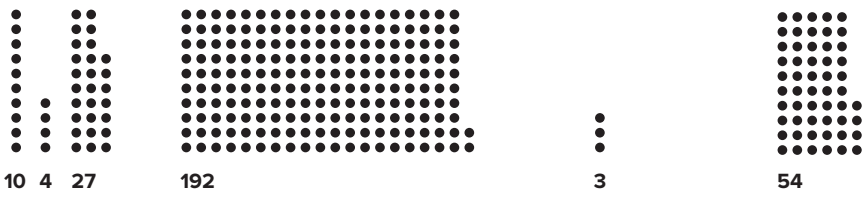

Targetti Sankey S.p.A.
Firenze – Italia

Targetti France S.a.S
Paris – France
Targetti Spain S.A.U.
Barcelona – Spain
Targetti UK Limited
London – United Kingdom

Firenze – Italy
Nusco – Italy

Targetti Sankey S.p.A.
Dubai – EAU

Targetti Lighting Co., Ltd
Beijing – China

Changzhou – China



**We love
research**

The flash of inspiration appears only
after travelling a long way

We are constantly on the lookout for new ideas.

Research is a fundamental part of the work we do and an indispensable part of our DNA: new technology, extraordinary ways of applying existing ones, more efficient lamps and new shapes and forms for optical systems. We do all of this because we want to share the ideas and original insights we produce every day

in our products. Our projects are based on continuous dialogue with professionals in the industry and specialised partners that start out as pure visions which are then shared, processed and adapted until they are turned into concrete results. This is the way we create tools that are capable of shining a better light on the market.



**Always
innovating**

Pushing the limits of imagination and technology forward

Innovating is a watchword for us.

At left Photographer: Guilherme Stecanella

Innovating is a watchword for us. It means surprising and impressing our partners but above all supplying them with out of the ordinary tools that provide original ideas in the design phase. If our products are innovative it is because they are the result of careful and tireless study.

We study the application of the latest technology available, the potential of new lamps and we collaborate with companies that are pioneers in design and lighting control. Once in the hands of lighting designers these solutions can create new and fascinating projects.





ZEDGE PRO designed in collaboration
with Gensler - Lauch 2018.



**We want
to experiment**

Emotions and the irresistible charm of inventing

At left Cantina Briziarelli - Bevagna Perugia , Italy
Architect: studio midesign
Photographer: Antonino Ciddio 2018.

We are always ready to venture into uncharted territory.

To find impressive solutions without ever giving up takes intuition, courage, enthusiasm and a dash of madness. For us experimenting new technology is thrilling as well as looking for the links between

LED and digitalisation that make even the most technical and complex fixtures simpler.

Results are never a foregone conclusion, sometimes we reach a dead end, but often we are presented with exciting, unexpected scenarios.



DBS

The Dynamic Beam Shaper (DBS) range started this way, from the desire to give designers a sophisticated yet simple to use tool. A technology that makes it possible to vary the beam opening of fixtures via digital input without any mechanical system.

With DBS we navigated uncharted waters, the combination of LED lamps, miniature reflectors and lenses fitted with liquid crystal molecules that can be activated using an electric field thus creating a light diffusion process.

Today DBS technology is available on five different product ranges,



Zeno



**CCTLED
Architectural**



Coro



Cloud



Ledò

soon it will also be available for other products such as:



**CCTLED
Architectural Mini**



**Cloud
Mini**



**Coro
Small**



**Zeno
Small**



Label 6

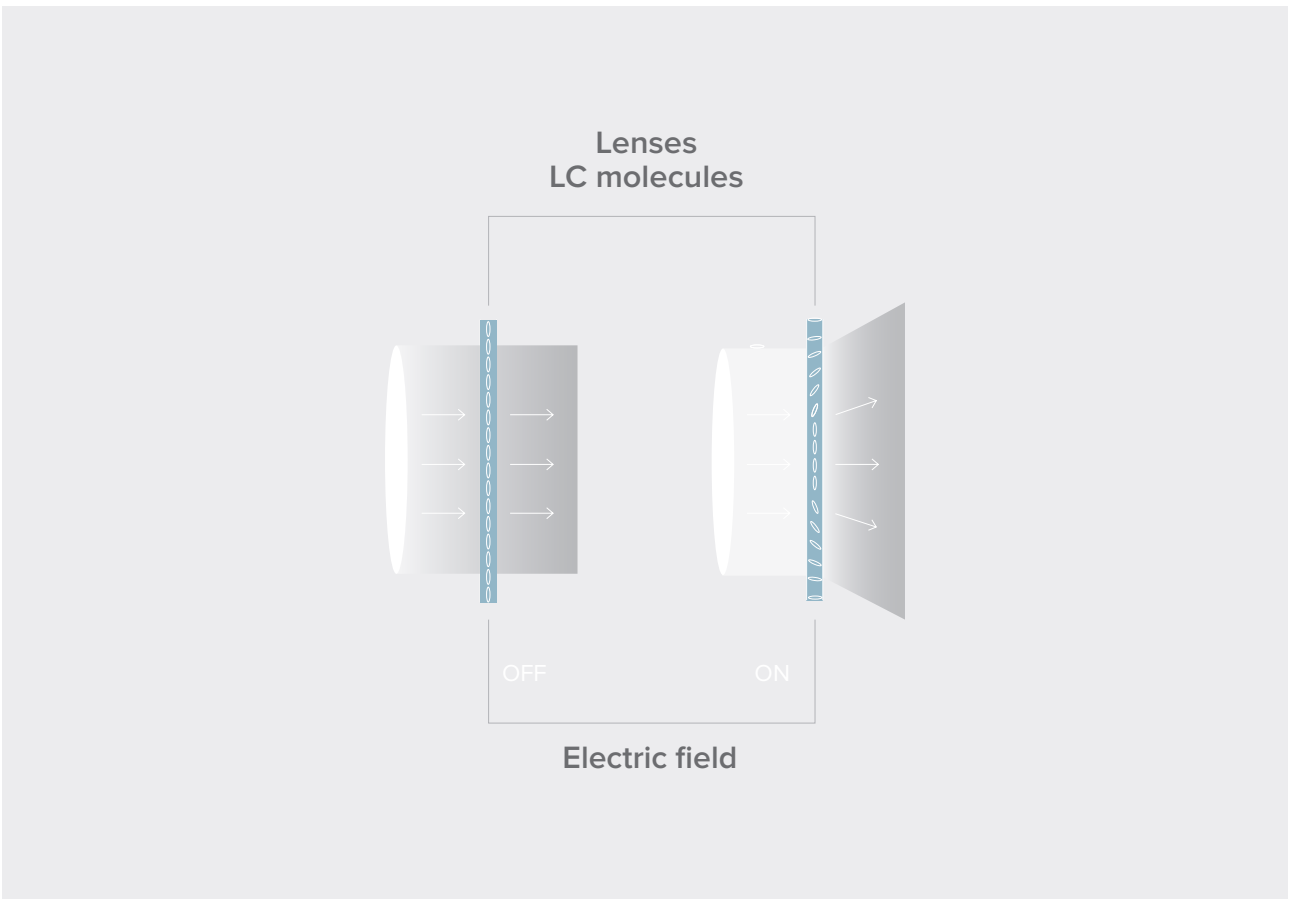
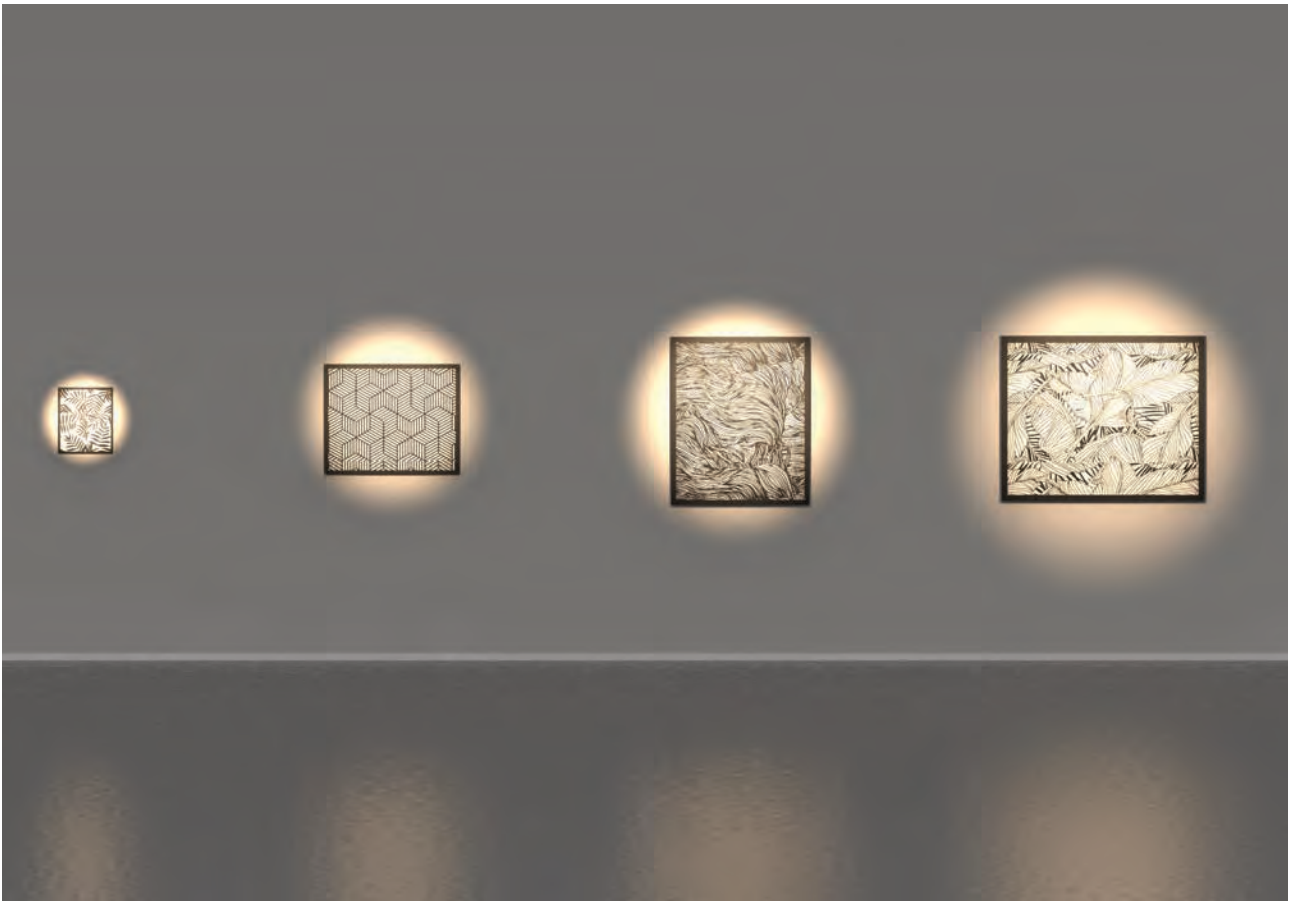



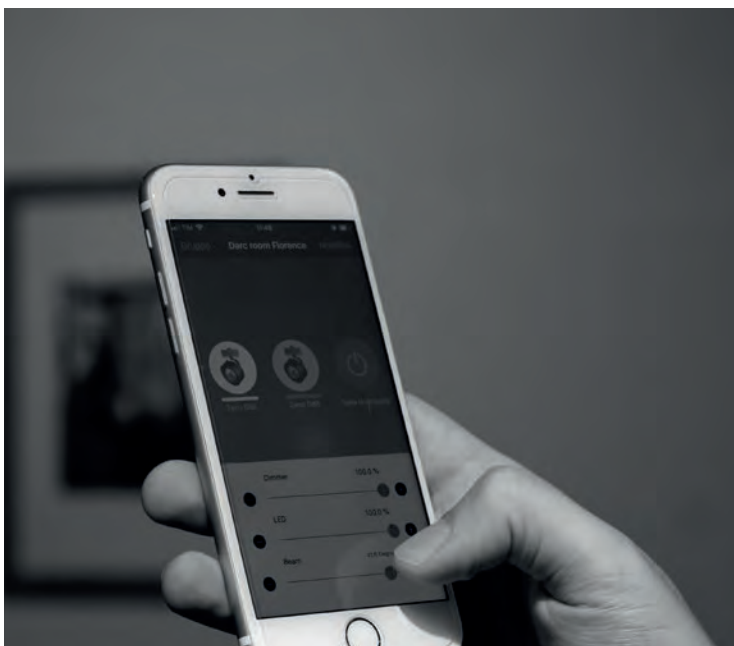

DBS

Control

We worked on a Joint Venture on this adventure to push the boundaries of light with Lens Vector, a leading American company in lens design.

DBS is controlled using an IoT system. Using a Casambi application available for IOS and Android it is possible to dim the source, set the desired beam opening and create dynamic scenes. The same fixture controlled by any smartphone opens up endless possibilities.



TONES

Searching for the best light

The TONES project started with the touch of madness we are famous from taking on the challenge to artificially create the best light for a variety of combinations and colours. A research project more than normal daily work that lasted almost a year, shared with a team of architects from the company Gensler, one of the largest architectural firms in the world. Together we analysed different combinations of materials and colours that are used in modern architecture and created the most suitable spectrum of light for each of them to enhance each composition, both as a whole as well as every single component. The team of architects evaluated the colour rendering of individual materials, the harmony and synchronicity between the various colours, the perception of different textures and contrast enhancement, in order to strengthen the expressive message as a whole. This was possible combining a series of LED that, as a whole, produce different tones of light, all with extremely rich emission spectrums to emphasize the different colours.

Seven different tones of light

Created digitally at first and then concretely reproduced to express various spectrums that have been specifically combined and shaped to enhance different combinations of materials and colours. A completely new, highly specialised light that has never been seen before.

The TONES range is ideal for domestic, retail, hotel and entertainment lighting, spaces where there is an interior design project that takes into account colours and materials aimed at creating a style and an atmosphere and to elicit particular emotions.





**We design
with you**

Unique tools and a desire to work together

We love every lighting project, we like being one of gears that drives the planning machine to enhance architecture to the full.

We work with our partners, we share the journey through the different project phases, we support them and we design custom made fixtures with them.

Our technicians study ad hoc solutions that adapt to space, design, optics, colours and size. Solutions that can become an integral part of the environment and meet ever-changing lighting needs.



Cattedrale di Santa Maria Assunta Volterra, Pisa

Lighting designer: Massimo Iarussi

For the Cattedrale Santa Maria Assunta in Volterra the lighting designer Massimo Iarussi, in collaboration with the Targetti R&D, designed decorative suspensions with a technological core.

The suspensions, made of alabaster, are a tribute that the lighting designer wanted to pay to the city, the European capital for processing this precious mineral, adding to the Cathedral a new element which is expression of artistic and artisan

work from the third millennium. The diffused light provided by the lanterns contribute to the general lighting in the church while the fixtures inside them light the ceiling providing scenographic zenithal accent lighting on the floor.











Targetti R&D department at Targetti created a kind of metal tray to house the fixtures for different lighting scenes. The lanterns play a triple role of contributing to the general lighting in the church, lighting the coffered ceiling and providing a more scenographic zenith light for the floor. A kind of ring made of LED strips surrounds the metal tray to provide a backlight for the alabaster suspension fixtures. Inside they are equipped with custom-made projectors inspired by the Zeno range, fitted with a special adjustable bracket to light the coffered ceiling. Finally, in the lower part of the lanterns there are small recessed projectors derived from the Label 48V range which are fixed to the metal trays using rods which zenithally light the floor.

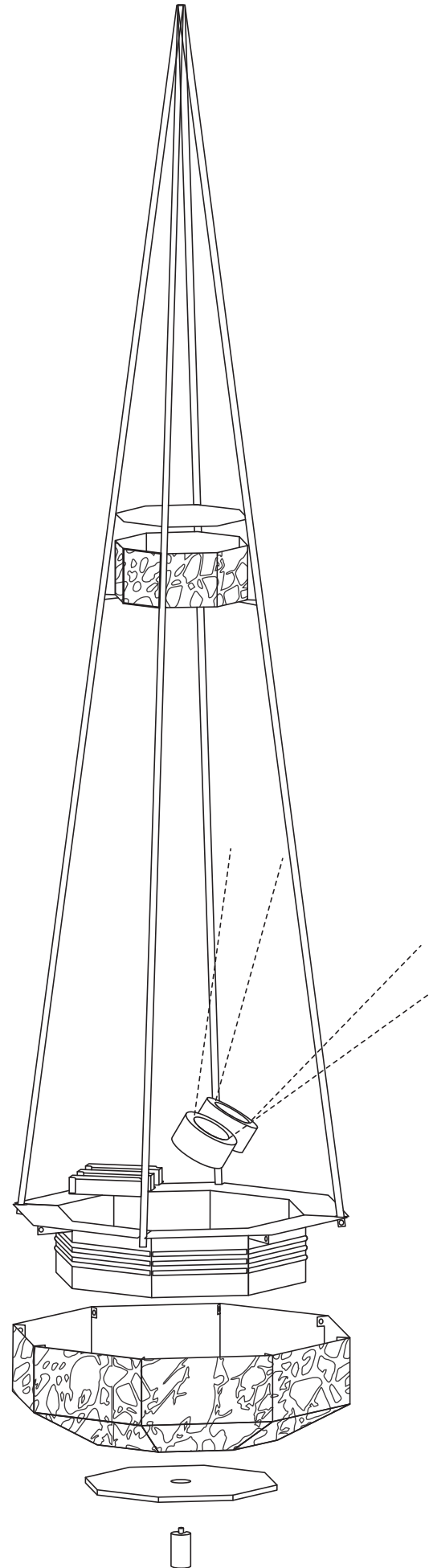



**We design
light**

A taste for distinguishing nuances

For us designing light is irresistible! We've been doing it for decades and it's our strength.

We put all our genius, passion and imagination into it. Creating surprising geometries, looking for new materials and getting light and space to interact together in increasingly original ways is something we never get tired of. Optical systems are the heart of a light fixture and we put our heart into designing them.

In the face of every shape, every new effect we discover, design and optimise we are always surprised just like the first time: it is the excitement to have found a solution using our imagination and the strength to make impossible dreams come true, or simply to have solved a complex problem brilliantly.

Every project and every space needs the right light.

We create the right light by designing optics, looking for new reflections and adding nuances and shades.

Today lighting does not just mean light and shade rather it is the art of adding weight or lightness to the myriad of nuances that separate them. This is why we have created a wide range of optics that add different – more significant – weight to nuances.

At first glance it could seem that a museum or a shop need to be

treated similarly: the same accent light that helps to focus attention towards objects. Yet if in a museum perfect, precise beams without any blurred edges and clean light to focus on the works on display are favoured, a shop uses softer gradient tones to attract people's attention without creating sharp boundaries and without favouring one product more than another. This was the reason behind the idea of creating optics with the same beam width that ensure effects with different gradient tones.

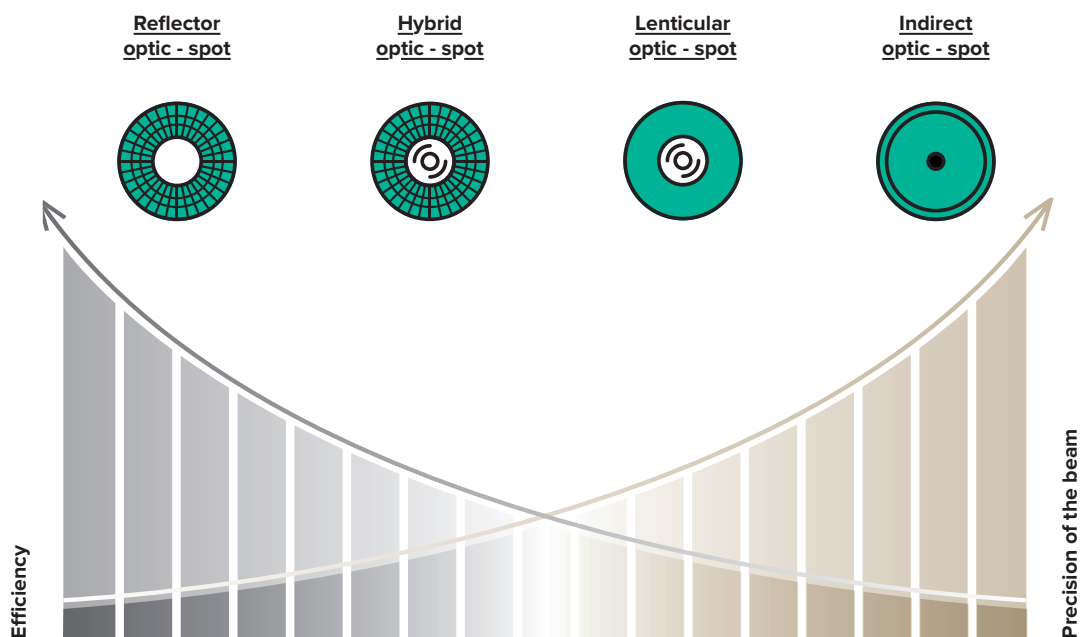

At right Chapelle du Collège
Carpentras, France
Sacha Leray Exposition
Photographer : Hugo Hebrard



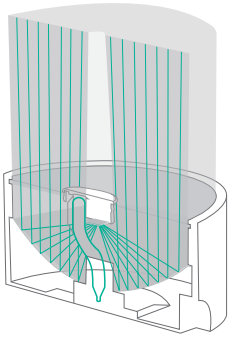

Indirect optics

Millimeter beam precision for evocative effects

One of the optics in the Targetti range is the indirect version, that makes it possible to obtain an extremely narrow light beam (6°) that is precise and well defined even at great distances. It uses the principle of lighting technology where a parabolic reflector is lit by a light source that is turned backwards and completely hidden from view. It works therefore by reflection, but the special shape makes the beams converge in an extraordinary way to create an extremely narrow, focused and defined effect with no falloff which is a normal result of uncontrolled light. Given its sophisticated shape this optic is only available in a Narrow Spot version.

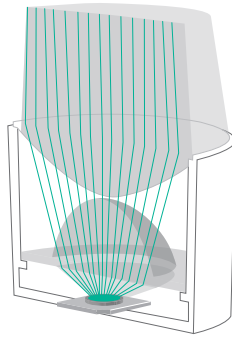

Lenticular optics

Sophisticated geometries for precise beams

These are most commonly used in museums because they make it possible to obtain precise and defined beams that frame works of art without interfering with the background. They are available from Narrow Spot right up to Flood openings. They are small in size, use high quality materials and have sophisticated shapes to collimate beams to eliminate all indirect emission components. This extreme precision entails a small sacrifice in terms of performance which in museums is not an essential requirement because low power fixtures are often used.

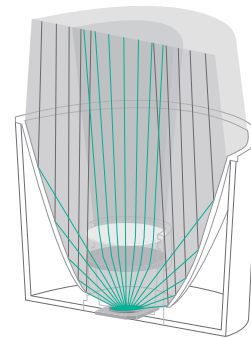

Hybrid optics

The best compromise between beam efficiency and definition

The light emission of these type of optics is the result of the combined use of reflectors and lenses. A reflector controls peripheral light while one or more lenses manage the central part of the beam which is usually uncontrolled. Cancelling "spurious" light is combined with flow recovery and an increase in the intensity inside the beam. These optics are available for Spot and Flood emissions.

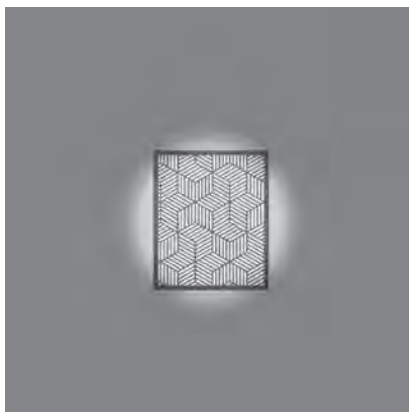

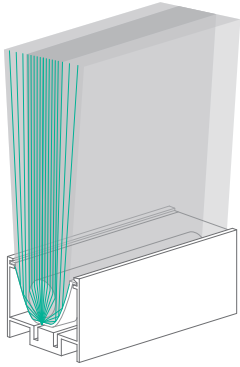

Grazing optics

Grazing lighting is a kind of light used to enhance vertical surfaces in a uniform way

With a gradient tone that moves away from the emitting source softly and is suitable for linear fixtures. Fixtures with this type of optic must be positioned near to the surface to be illuminated because the photometric solid is in reality a blade with maximum intensity at the emission point which then fades as it moves out. In the Targetti collection the Grazing optic was created thanks to an intuition by our optical department which studied a simple yet highly effective solution. It is a cylindrical lens positioned above the LED source along the entire length of the fixture. The result is a soft continuous light effect that "attaches" to the wall near the fixture without any unpleasant scorching, yet still able to reach the floor or the ceiling depending on where the fixture is positioned.

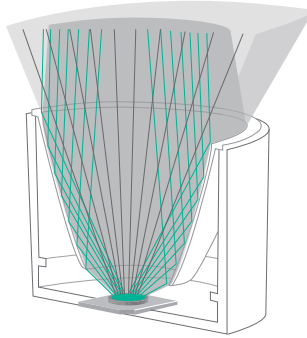

Reflector optics

Precise and enveloping light

These optics ensure the best performance and are available with all beam spread (spot, flood, medium wide flood and wide flood). They allow for excellent light mixing with broad, soft tones between light and shade. They are particularly suitable when a homogeneous balance between luminance and a more neutral and less dramatic effect is required. The reflective aluminium or metallised polycarbonate they are made of ensure high optical efficiency.

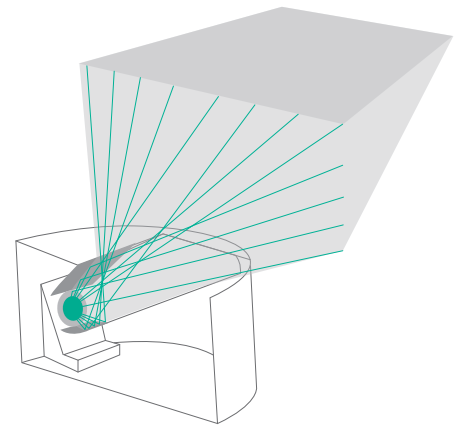

Wall Washer optics

Uniform light and contemporary atmosphere

These type of optics allow for completely uniform effects even on large wall surfaces. What makes them unique is the ability to direct the light right to the top of the surface and to its full height. The distance between different fixtures will provide uniformity along the entire length of the wall. Wall-washer optics are ideally used where uniformity is required in the entire space or where particular emphasis on a large work of art displayed on a wall is needed. The contrast with the rest of the space will emphasize the dramatic effect.

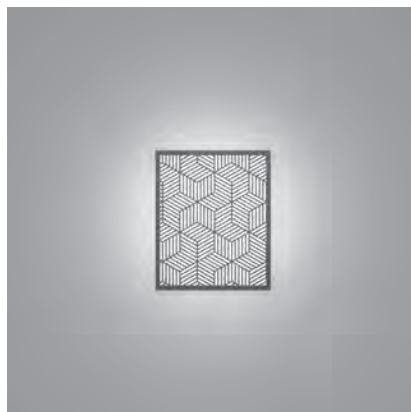
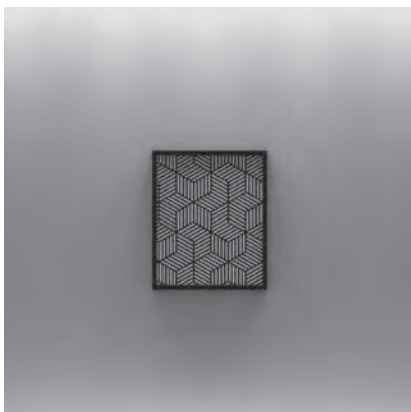



**Light is
colour**

Exalting the wealth of possible combinations every day

We do not like simplifications and standards, for us showing the inexhaustible potential of light is a responsibility and a duty.

Hues, tones and shades: every time we aspire to create the right composition for a particular material or a work of art we have taken on to reproduce its colours and essence with the utmost fidelity.

We have always chosen the LED source for our fixtures very carefully, LED lamps that are capable of ensuring high performance, long

life and excellent light quality. This means not choosing just one type of source for the entire collection but the ones we believe are the most suitable to be fitted in particular fixtures or new optical systems.

Despite this we are always able to ensure the same hue of light in all our fixtures.

TM30

TM-30-15 IES – is the acronym for the Illuminating Engineering Society – the organisation that developed the scale as a new method for evaluating the colour rendering of a light source. It appears to be more reliable than the previous Ra because it is based on the colour rendering comparison of 99 “colour patches” rather than 8+6 like the CRI. In addition, where the CRI provides a single score, therefore it does not significantly express

the narrow but broad relationship between light and colour, the TM-30 appears to be more complete because it is identified using three different parameters: an Rf Fidelity index, an Rg Gamut index and a colour vector graphic. These combine to provide a more accurate image of the colour fidelity of a light source and a better explanation of the exceptional colour rendering capabilities of LED sources.

Rf (Fidelity)

The TM-30 Fidelity index uses 99 colours, rather than 8+4 of the CRI, chosen from real world objects. Like the CRI the points of the Fidelity index go from 0 to 100. A score of less than 60 is too poor for indoor use and a 90+ score is ideal for an effect that is similar to daylight.

The TM-30, 99 “colour patches” are classified into seven groups (nature, skin tones, textiles, paints, plastics, printed material and colour systems). This categorisation helps because the light source can be tested on specific application areas.

Rg (Gamut)

Evaluates the intensity of colours under a certain light, therefore it provides indications of the source’s ability to reproduce colour saturation (breadth of colour range).

A score range equal to 100 indicates that the light source does not change the hue or colour saturation that are reproduced in the same way as the sample source.

R>100 indicates an increase in colour saturation, therefore they appear more intense.

R<100 indicates a decrease in saturation.

TM-30 colour vector graphic

Indicates which colours appear to be saturated and which desaturated. In the TM-30 colour vector graphic the black circle represents the sample light, while the red circle is the light being tested. If the circles overlap perfectly the tested light corresponds to sunlight.

The areas that extend beyond the black circle indicate that the colours are more intense compared to the sample, however those that remain inside represent colours that appear desaturated.

Unlike the Fidelity and Gamut indexes which are numerical scores, the colour vector graphic is a visual representation that makes it possible to understand which colours are more and less intense.

This is particularly useful when it is necessary to highlight a particular colour, for example in retail applications.

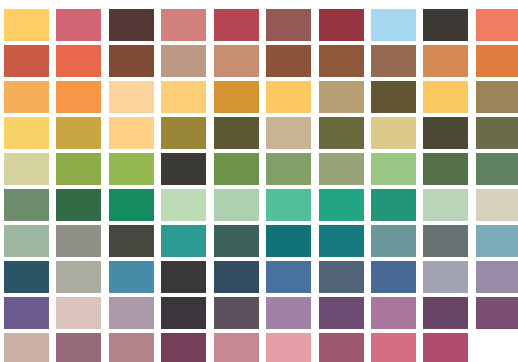

TM-30 Colour Range



COLOUR DISTORTION GRAPHIC

MacAdam

Another fundamental parameter for us when choosing a light source is Colour Tolerance, i.e. the colour characteristics of light highlighted by Step MacAdam.

Targetti fixtures equipped with LED COB have 1.5 step MacAdam guaranteed throughout the life of the source.

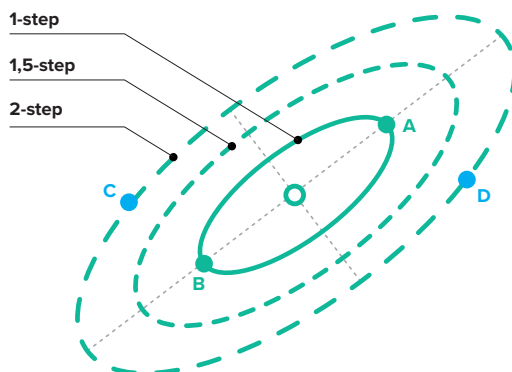
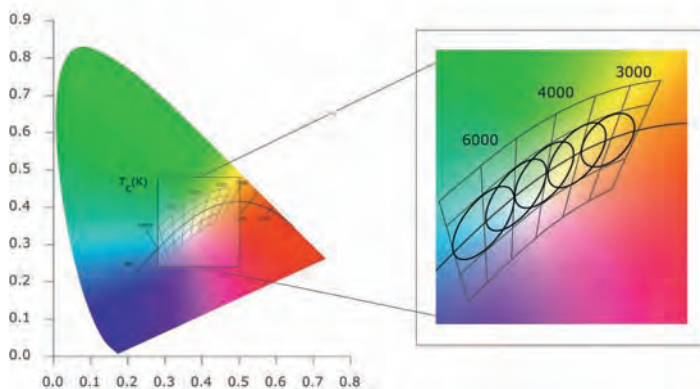

To help read the data it is possible to refer to the guide on page → 806



These are the LED sources our fixtures are fitted with

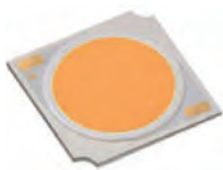

LED COB (chip on board)

This type provides maximum performance in terms of lumen, efficiency and density. They are typically made of a matrix of small blue chips covered in phosphorous. The large number of chips used makes it possible to achieve excellent efficiency while maintaining low current in individual chips.

COLOUR TEMPERATURE

2700 K • 3000 K
3500 K • 4000 K

EFFICACY

100 • 150 lm/W

COLOUR RENDERING

Ra84 • Ra92 • Ra97

COLOUR CONSISTENCY

1.5 SDCM
(Steps MacAdam)



LED Mid power

Characterised by high efficiency and low unit power (< 1W). This makes it possible to create large light sources. It is typically used in linear fixtures and in fixtures that have large emission areas of diffused light in order to obtain excellent performance while maintaining lower wattage.

COLOUR TEMPERATURE

2700 K • 3000 K
3500 K • 4000 K

EFFICACY

100 • 150 lm/W

COLOUR RENDERING

Ra84 • Ra92 • Ra97

COLOUR CONSISTENCY

2 SDCM
(Steps MacAdam)

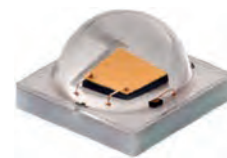

LED Emitter

Characterised by a very small light emitting area and high unit power (2-9W), it is typically used to make fixtures with predefined light beams.

COLOUR TEMPERATURE

2700 K • 3000 K
3500 K • 4000 K

EFFICACY

100 • 150 lm/W

COLOUR RENDERING

Ra84 • Ra92

COLOUR CONSISTENCY

3 SDCM
(Steps MacAdam)
2 SDCM on request

LED COB

LED COB Ra84 2700K

SOURCE
2700 K

R_f	84
R_g	95
CCT (K)	2714
D_{uv}	0,0000
x	0,4587
y	0,4102
CIE R_a	82,9
CIE R9	6,5

SPECTRAL POWER DISTRIBUTION COMPARISON

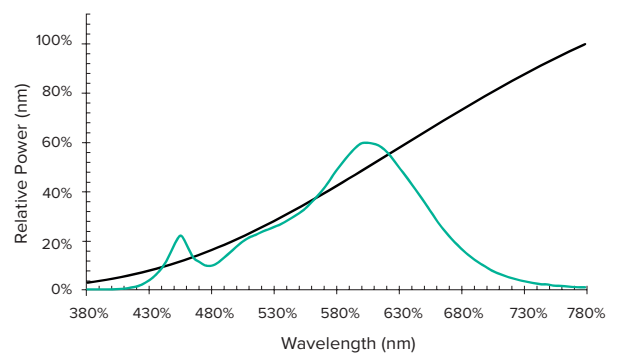

COLOUR DISTORTION GRAPHIC

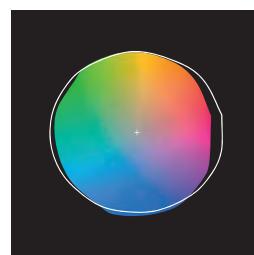

LED COB Ra84 3000K

SOURCE
3000 K

R_f	84
R_g	98
CCT (K)	3030
D_{uv}	0,0005
x	0,4356
y	0,4050
CIE R_a	84,2
CIE R9	16,1

SPECTRAL POWER
DISTRIBUTION COMPARISON

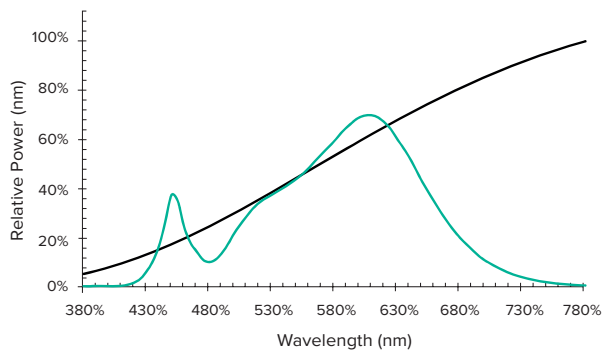

COLOUR DISTORTION
GRAPHIC



LED COB Ra85 4000K

SOURCE
4000 K

R_f	83
R_g	99
CCT (K)	3958
D_{uv}	0,0000
x	0,3823
y	0,3780
CIE R_a	85,2
CIE R9	20,9

SPECTRAL POWER
DISTRIBUTION COMPARISON

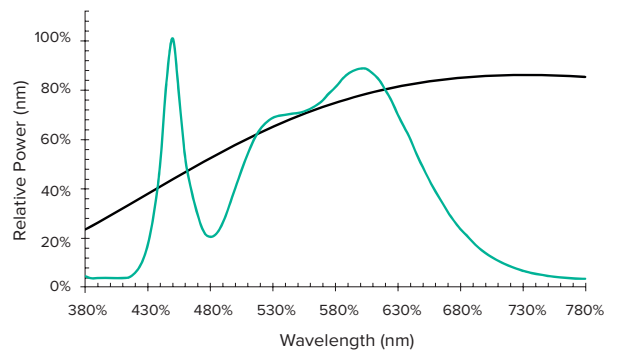

COLOUR DISTORTION
GRAPHIC



LED COB Ra93 3000K

SOURCE
3000 K

R_f	92
R_g	99
CCT (K)	3044
D_{uv}	0,0001
x	0,4340
y	0,4032
CIE R_a	93,7
CIE R9	61,5

SPECTRAL POWER DISTRIBUTION COMPARISON

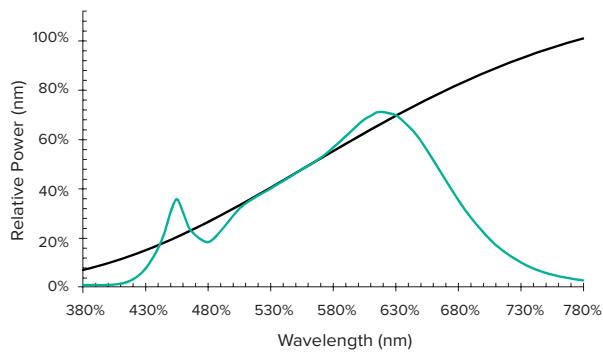

COLOUR DISTORTION GRAPHIC



LED COB Ra90 4000K

SOURCE
4000 K

R_f	90
R_g	98
CCT (K)	3980
D_{uv}	0,0011
x	0,3821
y	0,3800
CIE R_a	93,5
CIE R9	66,4

SPECTRAL POWER DISTRIBUTION COMPARISON

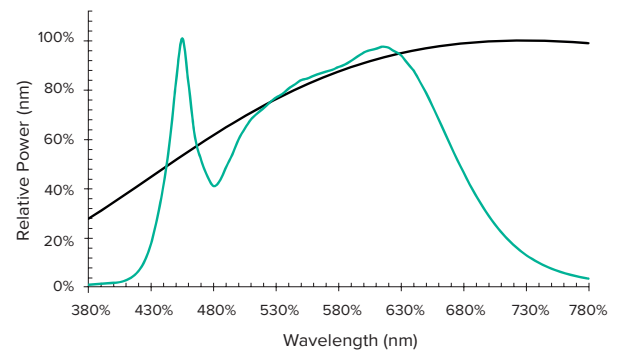

COLOUR DISTORTION GRAPHIC



LED COB Ra97 3000K

SOURCE
3000 K

R_f	96
R_g	102
CCT (K)	3006
D_{uv}	0,0001
x	0,4364
y	0,4036
CIE R_a	98,1
CIE R9	97,8

SPECTRAL POWER
DISTRIBUTION COMPARISON

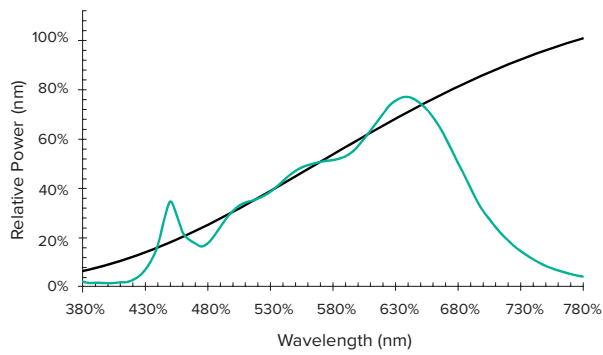

COLOUR DISTORTION
GRAPHIC



LED COB Ra97 4000K

SOURCE
4000 K

R_f	93
R_g	100
CCT (K)	3905
D_{uv}	0,0002
x	0,3849
y	0,3800
CIE R_a	98,4
CIE R9	99,2

SPECTRAL POWER
DISTRIBUTION COMPARISON

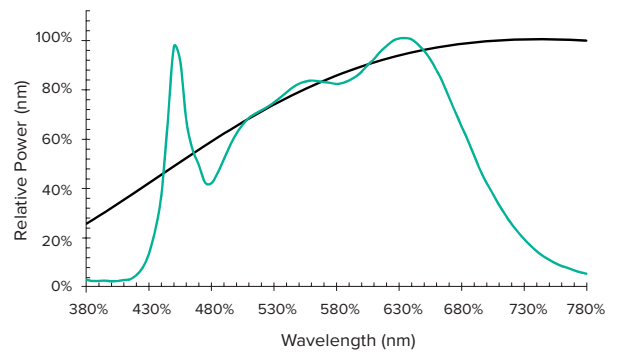

COLOUR DISTORTION
GRAPHIC





**We adorn
with light**

An essential addition to make a place unforgettable

When we work with architecture light is part of everything:

it must be functional to the project, enhance it and emphasise its communication message. To this purpose fixtures must discretely integrate into the architecture without overpowering it, participate as functional elements and if necessary disappear. This is why we dress our light with a simple yet at times meticulous design with canonical shapes that can be easily combined together. Colours are always simple to disappear into the environment: black, grey and white.

Architecture however is not always black and white, it can be an explosion of colours. Lighting has the task of adapting to its style.

This is why our fixtures can be painted, with any RAL finish (after the feasibility study) chosen by customers from the RAL Classic.

We have many colours to provide light with an ever changing style able to perfectly match any context.



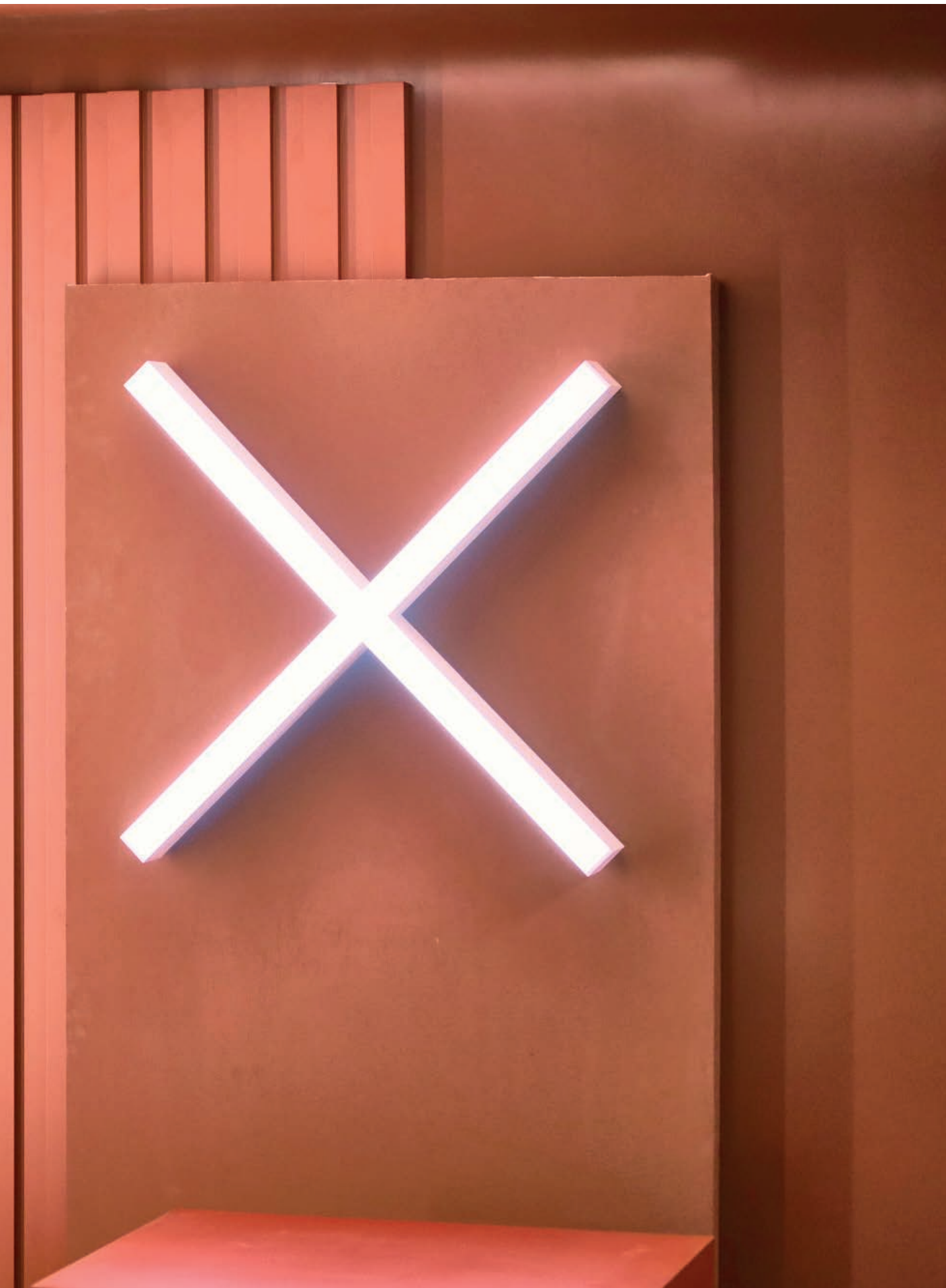



**We control
light**

Deciding on how much light, where and how in a few easy steps

The digital revolution – in particular the increase in Wi-Fi connections – has made it possible to control many everyday tools remotely, opening the door to simple and customised use of many things. Light is one of them.

At left Photographer: Sayo Garcia

Many of our fixtures can be activated and managed remotely using Bluetooth Low Energy (BLE) technology by Casambi, the leader company in wireless lighting control solutions.

By downloading a simple application onto a smartphone or tablet– for iOS and Android platforms- you can control your systems wirelessly however simple or complex it is.

It is possible to control every fixture

and decide whether to activate it individually or in combination with others depending on the needs and functionality required. Manage simple On-Off modes, dim sources, set up different configurations depending on specific functional requirements and even create dynamic scenes.

The system is also capable of interfacing with standard control Drivers such as Dali and 1-10V.

The fixtures in our collection are controlled using components integrated into the product or

external accessories. Our added value is the wide range of custom and standard devices available that have been developed to respond to even the most particular design needs in a flexible way.

Some simple icons in the catalogue help to identify fixtures in the collection that are already fitted with Casambi components and those to accessorise with special control units. You can find all the technical specifications and accessories in the control systems section of the catalogue.

At right Samsung KX , London - UK
Project: Heatherwick Studio
Lighting design: Nulty Lighting





News 2020 Indoor

Iso



Logico

New lighting modules



Omega



OZ

New modules



Label 2



Zeno Medium Zoom



News 2020

Outdoor

Zedge



Zedge bollard



Zedge Line Opal

Jupiter Pro



Mr & Mrs Smith



Keplero Mini Wall Washer



Jedi Compact Recessed



Coming soon

Zeno

Family



The Zeno range, designed to meet the lighting needs of exhibition spaces, will be subject to a restyling with the main objective being to minimise the size of the driver box.

A new design and faster installation. Integration into the architecture is then maximum when the option of the driver integrated into the track is selected. At present available on request. In 2021 also for the Medium version.

Label 7

The Label range is extending the family with the arrival of the new best performing Label 7! Available with two different optical systems, with lenses or reflectors to obtain performance and project-friendly effects with the same beam opening.



CCT EVO

Family



CCT EVO is here. Not a single “point of light” but an entire range of recessed fixtures developed on two different platforms to create two different types of products with the same family feeling.

“Architectural” recessed Downlight and Projector.

The Downlight is characterised by its essentiality, excellent performance, high efficiency, IP54 and the extent of the range. Lots of different diameters to choose from.

The Architectural platform is built around the Label range in order to have aesthetic and performance continuity between products with different installation types (track projectors, adjustable recessed projectors and extractable recessed projectors).

CCT EVO Architectural in accordance with Targetti tradition will be equipped with a complete set of accessories to design light according to requirements.

Even in this case there is an extensive range; the guiding principle is to create a range of products for different types of applications and sizes to provide a comprehensive collection of tools for our partners.



Coming soon

New DBS Range

The DBS programme is continuing and extending its range



OZ DBS

Targetti confirms its place as leader in the design of optical systems with new LCD micro-screens with a very small diameter compatible with the DBS system, engineered ad hoc for us.

Soon it will be possible to vary the beam opening of very small Oz light units even remotely.



CCTLED
Architectural Mini



Cloud
Mini



Coro
Small



Zeno
Small



Label 6

Ra > 90

Ra

State of art LED technology allows for good flux with high colour rendering.

Targetti has set themselves the goal of equipping all fixtures with LED Ra minimum >90 by 2021.

Indoor

Recessed

Linear recessed



82
LOGICO
Stand alone

Recessed



94
THREESIXTY



106
CCTLED
Smart-Tech-Feel



120
CCTLED
Smart-Tech-Feel
Trimless



117
CCTLED
Deep



118
CCTLED
Wall Washer

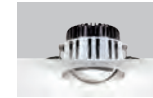

123
CCTLED
Wall Washer
Trimless



124
CCTLED
Mini



124
CCTLED
Mini WW



126
CCTLED
Micro



128
CCT Flash



132
CCTLED Arch.
Fix



144
CCTLED Arch.
Fix Trimless



138
CCTLED Arch.
Adj



146
CCTLED Arch.
Adj Trimless



141
CCTLED Arch.
HP Adj



151
CCTLED Arch.
Mini fix



152
CCTLED Arch.
Mini adj



158
CCTLED Arch.
Micro



160
OZ
Stand alone



176
STORE



192
ZENO Small



196
CLOUD



208
COZY



210
BEBOP



212
QUICKLED



214
POLKA



218
OTTO
Semi Recessed

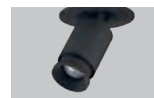

219
OTTO
Recessed

LOGICO

Stand Alone Recessed

GENERAL INFO

Modules of variable lengths with flange or trimless installation without visible frames.
Lengths: 1135mm – 1695mm – 3377mm

LED

LED engine
From 2520lm to 21600lm
3000K – 4000K
Ra84
Ra90 To order this version it is necessary to add the suffix "90" at the end of the standard code.

PRODUCT EFFICACY

Up to 109lm/W

OPTICS

OPAL – UGR – WW

POWER SUPPLY

Electronic – DALI
Casambi control: the DALI version is fitted with special accessories.

MATERIAL

Powder coated, extruded, calendered aluminium.

A versatile fixture available in three different lengths, each with Low- Power and High-Power lumen and different finishes and installation types.

There are two different versions available. One with a light module without a flange to be accessorised with an outer casing for trimless installation or with a flange, and a light module with a flange that does not require an outer casing. It can be also in semi-recessed installation.

It is available with diffused light, UGR<19 controlled light ideal for lighting workplaces or wall-washer for lighting large vertical surfaces.

There are also versions available for ceiling, wall or suspension installation.





Zonamerica

Architect
Estudio Dovat
Arquitectos

Lighting Design
Estudio Hofstadter

Photographer
Ferrés - Cánepa

Country
Montevideo,
Uruguay

01



Magnetic assembling

A magnet makes it possible to fix the light unit complete with a reflector to the housing, while the screen is attached with a simple “click”. No need to use tools. This particular fastening system means that the fixture can also be wall mounted.

02



Recessed version with or without a flange

The version without the flange allows for a trimless finish that totally disappears into the ceiling or for semi-recessed installations. Just accessorise the fixture with a special casing to be fitted flush into the ceiling.

Solutions available on request

Custom tailor made length modules and emergency modules.

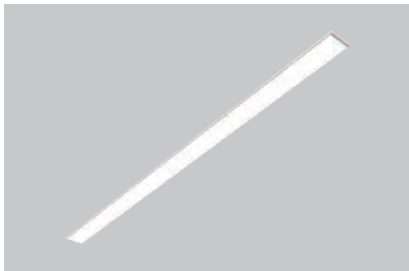

Stand Alone Recessed L. 1135mm

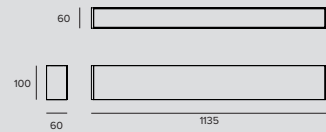

LED / 24W / DOWN OPAL



		3000K	H(m)	D(m)	Emax(lx)	
		Ra84		106°		
Fixture Power	27W	1	2.66	903		
Source Flux	3480lm	2	5.33	226		
Fixture Flux	2370lm	3	7.99	100		
Efficacy	88lm/W	4	10.65	56		
TS991	Imax=259cd/klm	Imax	903cd	5	13.32	36

Driver	Colour	3000K	4000K
EL.	○	1T5779EL	1T5780EL
EL.	●	1T5781EL	1T5782EL
DALI	○	1T5779DA	1T5780DA
DALI	●	1T5781DA	1T5782DA

LED / 48W / DOWN OPAL



		3000K	H(m)	D(m)	Emax(lx)	
		Ra84		106°		
Fixture Power	54W	1	2.66	1785		
Source Flux	6880lm	2	5.33	446		
Fixture Flux	4685lm	3	7.99	198		
Efficacy	87lm/W	4	10.65	112		
TS996	Imax=259cd/klm	Imax	1785cd	5	13.32	71

Driver	Colour	3000K	4000K
EL.	○	1T5783EL	1T5784EL
EL.	●	1T5785EL	1T5786EL
DALI	○	1T5783DA	1T5784DA
DALI	●	1T5785DA	1T5786DA

LED / 16W / DOWN UGR



		3000K	H(m)	D(m)	Emax(lx)	
		Ra84		74°		
Fixture Power	18W	1	1.51	1113		
Source Flux	2520lm	2	3.02	278		
Fixture Flux	1631lm	3	4.52	124		
Efficacy	91lm/W	4	6.03	70		
TS992	Imax=442cd/klm	Imax	1113cd	5	7.54	45

Driver	Colour	3000K	4000K
EL.	○	1T5787EL	1T5788EL
EL.	●	1T5789EL	1T5790EL
DALI	○	1T5787DA	1T5788DA
DALI	●	1T5789DA	1T5790DA

LED / 24W / DOWN WW



		3000K	H(m)	D1(m)	D2(m)	Emax(lx)	
		Ra84		97°	101°		
Fixture Power	27W	1	2.28	2.55	2801		
Source Flux	3480lm	2	4.56	5.10	700		
Fixture Flux	2739lm	3	6.84	7.64	311		
Efficacy	101lm/W	4	9.12	10.19	175		
TS993	Imax=1001cd/klm	Imax	3485cd	5	11.40	12.74	112

Driver	Colour	3000K	4000K
EL.	○	1T5791EL	1T5792EL
EL.	●	1T5793EL	1T5794EL
DALI	○	1T5791DA	1T5792DA
DALI	●	1T5793DA	1T5794DA

LED / 48W / DOWN WW



		3000K	H(m)	D1(m)	D2(m)	Emax(lx)	
		Ra84		97°	101°		
Fixture Power	54W	1	2.28	2.55	5537		
Source Flux	6880lm	2	4.56	5.10	1384		
Fixture Flux	5415lm	3	6.84	7.64	615		
Efficacy	100lm/W	4	9.12	10.19	346		
TS997	Imax=1001cd/klm	Imax	6890cd	5	11.40	12.74	221

Driver	Colour	3000K	4000K
EL.	○	1T5795EL	1T5796EL
EL.	●	1T5797EL	1T5798EL
DALI	○	1T5795DA	1T5796DA
DALI	●	1T5797DA	1T5798DA

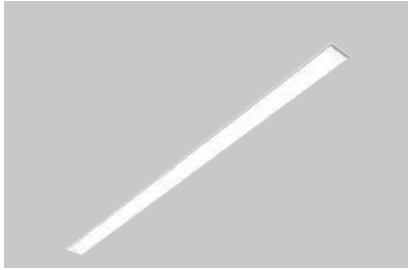

Stand Alone Recessed L. 1695mm

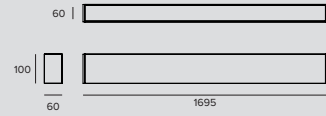

LED / 36W / DOWN OPAL



		3000K	H(m)	D(m)	Emax(lx)	
		Ra84		106°		
Fixture Power	40W	1	2.66	1354		
Source Flux	5220lm	2	5.33	338		
Fixture Flux	3555lm	3	7.99	150		
Efficacy	89lm/W	4	10.65	85		
TS991	Imax=259cd/klm	Imax	1354cd	5	13.32	54

Driver	Colour	3000K	4000K
EL.	○	1T5799EL	1T5800EL
EL.	●	1T5801EL	1T5802EL
DALI	○	1T5799DA	1T5800DA
DALI	●	1T5801DA	1T5802DA

LED / 72W / DOWN OPAL



		3000K	H(m)	D(m)	Emax(lx)	
		Ra84		106°		
Fixture Power	81W	1	2.66	2677		
Source Flux	10320lm	2	5.33	669		
Fixture Flux	7028lm	3	7.99	297		
Efficacy	87lm/W	4	10.65	167		
TS996	Imax=259cd/klm	Imax	2677cd	5	13.32	107

Driver	Colour	3000K	4000K
EL.	○	1T5803EL	1T5804EL
EL.	●	1T5805EL	1T5806EL
DALI	○	1T5803DA	1T5804DA
DALI	●	1T5805DA	1T5806DA

LED / 24W / DOWN UGR



		3000K	H(m)	D(m)	Emax(lx)	
		Ra84		74°		
Fixture Power	27W	1	1.51	1669		
Source Flux	3780lm	2	3.02	417		
Fixture Flux	2447lm	3	4.52	185		
Efficacy	91lm/W	4	6.03	104		
TS992	Imax=442cd/klm	Imax	1669cd	5	7.54	67

Driver	Colour	3000K	4000K
EL.	○	1T5807EL	1T5808EL
EL.	●	1T5809EL	1T5810EL
DALI	○	1T5807DA	1T5808DA
DALI	●	1T5809DA	1T5810DA

LED / 36W / DOWN WW



		3000K	H(m)	D1(m)	D2(m)	Emax(lx)	
		Ra84		97°	101°		
Fixture Power	40W	1	2.28	2.55	4201		
Source Flux	5220lm	2	4.56	5.10	1050		
Fixture Flux	4108lm	3	6.84	7.64	467		
Efficacy	103lm/W	4	9.12	10.19	263		
TS993	Imax=1001cd/klm	Imax	5228cd	5	11.40	12.74	168

Driver	Colour	3000K	4000K
EL.	○	1T5811EL	1T5812EL
EL.	●	1T5813EL	1T5814EL
DALI	○	1T5811DA	1T5812DA
DALI	●	1T5813DA	1T5814DA

LED / 72W / DOWN WW



		3000K	H(m)	D1(m)	D2(m)	Emax(lx)	
		Ra84		97°	101°		
Fixture Power	81W	1	2.28	2.55	8305		
Source Flux	10320lm	2	4.56	5.10	2076		
Fixture Flux	8122lm	3	6.84	7.64	923		
Efficacy	100lm/W	4	9.12	10.19	519		
TS997	Imax=1001cd/klm	Imax	10335cd	5	11.40	12.74	332

Driver	Colour	3000K	4000K
EL.	○	1T5815EL	1T5816EL
EL.	●	1T5817EL	1T5818EL
DALI	○	1T5815DA	1T5816DA
DALI	●	1T5817DA	1T5818DA

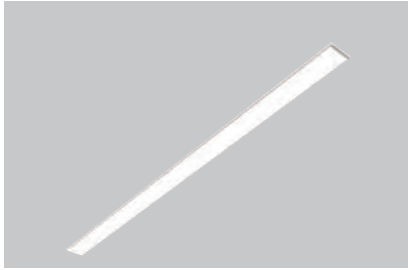

Stand Alone Recessed L. 3377mm

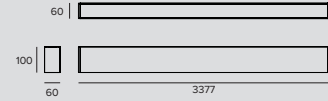

LED / 72W / DOWN OPAL						
		3000K	H(m)	D(m)	Emax(lx)	
		Ra84		106°		
Fixture Power	81W	1	2.66	2708		
Source Flux	10440lm	2	5.33	677		
Fixture Flux	7110lm	3	7.99	301		
Efficacy	88lm/W	4	10.65	169		
TS991	Imax=259cd/klm	Imax	2708cd	5	13.32	108

Driver	Colour	3000K	4000K
EL.	○	1T5819EL	1T5820EL
EL.	●	1T5821EL	1T5822EL
DALI	○	1T5819DA	1T5820DA
DALI	●	1T5821DA	1T5822DA

LED / 144W / DOWN OPAL						
		3000K	H(m)	D(m)	Emax(lx)	
		Ra84		106°		
Fixture Power	163W	1	2.66	5354		
Source Flux	20640lm	2	5.33	1338		
Fixture Flux	14056lm	3	7.99	595		
Efficacy	86lm/W	4	10.65	335		
TS996	Imax=259cd/klm	Imax	5354cd	5	13.32	214

Driver	Colour	3000K	4000K
EL.	○	1T5823EL	1T5824EL
EL.	●	1T5825EL	1T5826EL
DALI	○	1T5823DA	1T5824DA
DALI	●	1T5825DA	1T5826DA

LED / 48W / DOWN UGR						
		3000K	H(m)	D(m)	Emax(lx)	
		Ra84		74°		
Fixture Power	54W	1	1.51	3338		
Source Flux	7560lm	2	3.02	834		
Fixture Flux	4894lm	3	4.52	371		
Efficacy	91lm/W	4	6.03	209		
TS992	Imax=442cd/klm	Imax	3338cd	5	7.54	134

Driver	Colour	3000K	4000K
EL.	○	1T5827EL	1T5828EL
EL.	●	1T5829EL	1T5830EL
DALI	○	1T5827DA	1T5828DA
DALI	●	1T5829DA	1T5830DA

LED / 72W / DOWN WW							
		3000K	H(m)	D1(m)	D2(m)	Emax(lx)	
		Ra84		97°	101°		
Fixture Power	81W	1	2.28	2.55	8402		
Source Flux	10440lm	2	4.56	5.10	2101		
Fixture Flux	8216lm	3	6.84	7.64	934		
Efficacy	101lm/W	4	9.12	10.19	525		
TS993	Imax=1001cd/klm	Imax	10455cd	5	11.40	12.74	336

Driver	Colour	3000K	4000K
EL.	○	1T5831EL	1T5832EL
EL.	●	1T5833EL	1T5834EL
DALI	○	1T5831DA	1T5832DA
DALI	●	1T5833DA	1T5834DA

Note

Check mounting instructions to verify the quantity of DALI drivers installed.

LOGICO

LED / 144W / DOWN WW



	3000K	H(m)	D1(m)	D2(m)	E _{max} (lx)
Ra84			97*	101*	
Fixture Power	163W	1	2.28	2.55	16611
Source Flux	20640lm	2	4.56	5.10	4153
Fixture Flux	16244lm	3	6.84	7.64	1846
Efficacy	100lm/W	4	9.12	10.19	1038
TS997	Imax=1001cd/klm Imax	20670cd	5	11.40	12.74 664

Driver	Colour	3000K	4000K
EL.	○	1T5835EL	1T5836EL
EL.	●	1T5837EL	1T5838EL
DALI	○	1T5835DA	1T5836DA
DALI	●	1T5837DA	1T5838DA

Note

Check mounting instructions to verify the quantity of DALI drivers installed.

Related codes

Insertion Box

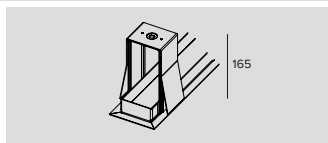

Kg	Cutout hole	L	Colour	Code
3.2	80x1150	1171	○	1T5918
3.8	80x1710	1731	○	1T5919
7.5	80x3390	3416	○	1T5920

Outer casing for recessed and semi-recessed installation with a flange.

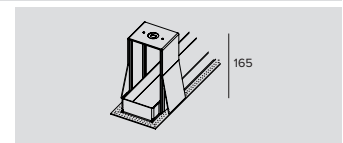

Kg	Cutout hole	L	Code
3.2	80x1150	1172	1T6012
3.8	80x1710	1732	1T6013
7.5	80x3390	3414	1T6014

Outer casing for recessed and semi-recessed trimless installation.

Accessories

Screen

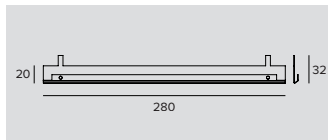

Code
1T6502

Accessory designed to improve the visual comfort of the Wall Washer version.
To be installed on a standard reflector.
Made of matte black painted aluminium.
280mm in length; to be ordered in the following quantities for every fixture length: 4 for the 1122/1135/1146mm versions, 6 for the 1682/1695/1706mm versions and 12 for the 3364/3377/3386mm versions.

Control systems



Code
1T5349

Wireless control unit for DALI fixtures.
It generates a local DALI bus that can control individual fixtures.
The module can be connected to an existing DALI network.
The module is wireless controlled using a Casambi app for smartphones and tablets using Bluetooth 4.0 technology.
The devices create a wireless mesh network that can control up to 128 fixtures.
IP20.



Code
1T5352

IP20 Extender for wireless control of DALI fixtures.
It generates a local DALI bus with the capacity to drive up to 64 fixtures.
Can control DALI fixtures in indoor applications.
It is also equipped with a relay that can control non-dimmable fixtures up to a maximum of 6A.

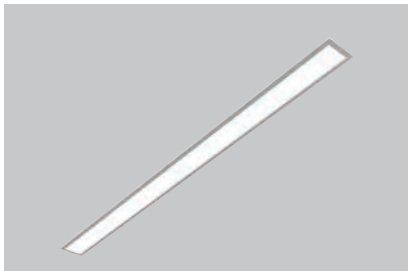

Stand Alone Recessed with flange L. 1146mm

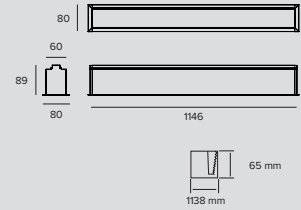

LED / 24W / DOWN OPAL



		3000K	H(m)	D(m)	E _{max} (lx)	
		Ra84		106°		
Fixture Power	27W	1	2.66	903		
Source Flux	3480lm	2	5.33	226		
Fixture Flux	2370lm	3	7.99	100		
Efficacy	88lm/W	4	10.65	56		
TS991	Imax=259cd/klm	Imax	903cd	5	13.32	36

Driver	Colour	3000K	4000K
EL.	○	1T5431EL	1T5432EL
DALI	○	1T5431DA	1T5432DA

LED / 48W / DOWN OPAL



		3000K	H(m)	D(m)	E _{max} (lx)	
		Ra84		106°		
Fixture Power	54W	1	2.66	1785		
Source Flux	6880lm	2	5.33	446		
Fixture Flux	4685lm	3	7.99	198		
Efficacy	87lm/W	4	10.65	112		
TS996	Imax=259cd/klm	Imax	1785cd	5	13.32	71

Driver	Colour	3000K	4000K
EL.	○	1T5433EL	1T5434EL
DALI	○	1T5433DA	1T5434DA

LED / 16W / DOWN UGR



		3000K	H(m)	D(m)	E _{max} (lx)	
		Ra84		74°		
Fixture Power	18W	1	1.51	1113		
Source Flux	2520lm	2	3.02	278		
Fixture Flux	1631lm	3	4.52	124		
Efficacy	91lm/W	4	6.03	70		
TS992	Imax=442cd/klm	Imax	1113cd	5	7.54	45

Driver	Colour	3000K	4000K
EL.	○	1T5435EL	1T5436EL
DALI	○	1T5435DA	1T5436DA

LED / 24W / DOWN WW



		3000K	H(m)	D1(m)	D2(m)	E _{max} (lx)	
		Ra84		97°	101°		
Fixture Power	27W	1	2.28	2.55	2801		
Source Flux	3480lm	2	4.56	5.10	700		
Fixture Flux	2739lm	3	6.84	7.64	311		
Efficacy	101lm/W	4	9.12	10.19	175		
TS993	Imax=1001cd/klm	Imax	3485cd	5	11.40	12.74	112

Driver	Colour	3000K	4000K
EL.	○	1T5437EL	1T5438EL
DALI	○	1T5437DA	1T5438DA

LED / 48W / DOWN WW



		3000K	H(m)	D1(m)	D2(m)	E _{max} (lx)	
		Ra84		97°	101°		
Fixture Power	54W	1	2.28	2.55	5537		
Source Flux	6880lm	2	4.56	5.10	1384		
Fixture Flux	5415lm	3	6.84	7.64	615		
Efficacy	100lm/W	4	9.12	10.19	346		
TS997	Imax=1001cd/klm	Imax	6890cd	5	11.40	12.74	221

Driver	Colour	3000K	4000K
EL.	○	1T5439EL	1T5440EL
DALI	○	1T5439DA	1T5440DA

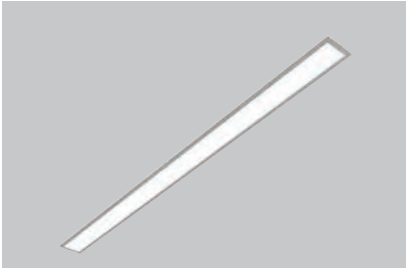

Stand Alone Recessed with flange L. 1706mm

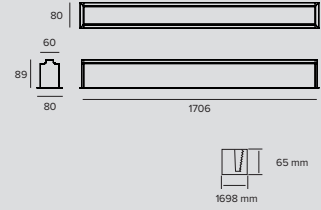

LED / 36W / DOWN OPAL ⊕ 5 IP20

	3000K	H(m)	D(m)	E _{max} (lx)	
	Ra84		106°		
	Fixture Power	40W	1	2.66	1354
	Source Flux	5220lm	2	5.33	338
	Fixture Flux	3555lm	3	7.99	150
	Efficacy	89lm/W	4	10.65	85

TS991 I_{max}=259cd/klm I_{max} 1354cd 5 13.32 54

Driver	Colour	3000K	4000K
EL.	○	1T5441EL	1T5442EL
DALI	○	1T5441DA	1T5442DA

LED / 72W / DOWN OPAL ⊕ 5 IP20

	3000K	H(m)	D(m)	E _{max} (lx)	
	Ra84		106°		
	Fixture Power	81W	1	2.66	2677
	Source Flux	10320lm	2	5.33	669
	Fixture Flux	7028lm	3	7.99	297
	Efficacy	87lm/W	4	10.65	167

TS996 I_{max}=259cd/klm I_{max} 2677cd 5 13.32 107

Driver	Colour	3000K	4000K
EL.	○	1T5443EL	1T5444EL
DALI	○	1T5443DA	1T5444DA

LED / 24W / DOWN UGR ⊕ 5 IP20

	3000K	H(m)	D(m)	E _{max} (lx)	
	Ra84		74°		
	Fixture Power	27W	1	1.51	1669
	Source Flux	3780lm	2	3.02	417
	Fixture Flux	2447lm	3	4.52	185
	Efficacy	91lm/W	4	6.03	104

TS992 I_{max}=442cd/klm I_{max} 1669cd 5 7.54 67

Driver	Colour	3000K	4000K
EL.	○	1T5445EL	1T5446EL
DALI	○	1T5445DA	1T5446DA

LED / 36W / DOWN WW ⊕ 5 IP20

	3000K	H(m)	D1(m)	D2(m)	E _{max} (lx)	
	Ra84		97°	101°		
	Fixture Power	40W	1	2.28	2.55	4201
	Source Flux	5220lm	2	4.56	5.10	1050
	Fixture Flux	4108lm	3	6.84	7.64	467
	Efficacy	103lm/W	4	9.12	10.19	263

TS993 I_{max}=1001cd/klm I_{max} 5228cd 5 11.40 12.74 168

Driver	Colour	3000K	4000K
EL.	○	1T5447EL	1T5448EL
DALI	○	1T5447DA	1T5448DA

LED / 72W / DOWN WW ⊕ 5 IP20

	3000K	H(m)	D1(m)	D2(m)	E _{max} (lx)	
	Ra84		97°	101°		
	Fixture Power	81W	1	2.28	2.55	8305
	Source Flux	10320lm	2	4.56	5.10	2076
	Fixture Flux	8122lm	3	6.84	7.64	923
	Efficacy	100lm/W	4	9.12	10.19	519

TS997 I_{max}=1001cd/klm I_{max} 10335cd 5 11.40 12.74 332

Driver	Colour	3000K	4000K
EL.	○	1T5449EL	1T5450EL
DALI	○	1T5449DA	1T5450DA



Stand Alone Recessed with flange L. 3386mm

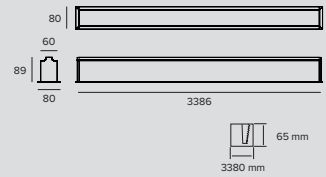

LED / 72W / DOWN OPAL ± 10.5 IP20

		3000K	H(m)	D(m)	E _{max} (lx)	
Ra84				106°		
Fixture Power	81W	1	2.66	2708		
Source Flux	10440lm	2	5.33	677		
Fixture Flux	7110lm	3	7.99	301		
Efficacy	88lm/W	4	10.65	169		
TS991	Imax=259cd/klm	Imax	2708cd	5	13.32	108

Driver	Colour	3000K	4000K
EL.	○	1T5451EL	1T5452EL
DALI	○	1T5451DA	1T5452DA

LED / 144W / DOWN OPAL ± 10.5 IP20

		3000K	H(m)	D(m)	E _{max} (lx)	
Ra84				106°		
Fixture Power	163W	1	2.66	5354		
Source Flux	20640lm	2	5.33	1338		
Fixture Flux	14056lm	3	7.99	595		
Efficacy	86lm/W	4	10.65	335		
TS996	Imax=259cd/klm	Imax	5354cd	5	13.32	214

Driver	Colour	3000K	4000K
EL.	○	1T5453EL	1T5454EL
DALI	○	1T5453DA	1T5454DA

LED / 48W / DOWN UGR ± 10.5 IP20

		3000K	H(m)	D(m)	E _{max} (lx)	
Ra84				74°		
Fixture Power	54W	1	1.51	3338		
Source Flux	7560lm	2	3.02	834		
Fixture Flux	4894lm	3	4.52	371		
Efficacy	91lm/W	4	6.03	209		
TS992	Imax=442cd/klm	Imax	3338cd	5	7.54	134

Driver	Colour	3000K	4000K
EL.	○	1T5455EL	1T5456EL
DALI	○	1T5455DA	1T5456DA

LED / 72W / DOWN WW ± 10.5 IP20

		3000K	H(m)	D1(m)	D2(m)	E _{max} (lx)	
Ra84				97°	101°		
Fixture Power	81W	1	2.28	2.55	8402		
Source Flux	10440lm	2	4.56	5.10	2101		
Fixture Flux	8216lm	3	6.84	7.64	934		
Efficacy	101lm/W	4	9.12	10.19	525		
TS993	Imax=1001cd/klm	Imax	10455cd	5	11.40	12.74	336

Driver	Colour	3000K	4000K
EL.	○	1T5457EL	1T5458EL
DALI	○	1T5457DA	1T5458DA

Note

Check mounting instructions to verify the quantity of DALI drivers installed.

LOGICO

LED / 144W / DOWN WW



		3000K			
		H(m)	D1(m)	D2(m)	E _{max} (lx)
Ra84			97*	101*	
Fixture Power	163W	1	2.28	2.55	16611
Source Flux	20640lm	2	4.56	5.10	4153
Fixture Flux	16244lm	3	6.84	7.64	1846
Efficacy	100lm/W	4	9.12	10.19	1038
TS997	Imax=1001cd/klm Imax	5	11.40	12.74	664

Driver	Colour	3000K	4000K
EL	○	1T5459EL	1T5460EL
DALI	○	1T5459DA	1T5460DA

Note

Check mounting instructions to verify the quantity of DALI drivers installed.

Accessories

Screen

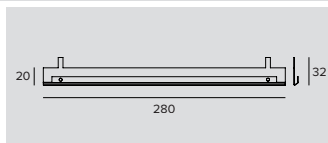

Code

1T6502

Accessory designed to improve the visual comfort of the Wall Washer version.

To be installed on a standard reflector.

Made of matte black painted aluminium.

280mm in length; to be ordered in the following quantities for every fixture length: 2 for the 562mm version, 4 for the 1122/1135/1146mm versions, 6 for the 1682/1695/1706mm versions and 12 for the 3364/3377/3386mm versions.

Control systems



Code

1T5349

Wireless control unit for DALI fixtures.

It generates a local DALI bus that can control individual fixtures.

The module can be connected to an existing DALI network.

The module is wireless controlled using a Casambi app for smartphones and tablets using Bluetooth 4.0 technology.

The devices create a wireless mesh network that can control up to 128 fixtures.

IP20.



Code

1T5352

IP20 Extender for wireless control of DALI fixtures.

It generates a local DALI bus with the capacity to drive up to 64 fixtures.

Can control DALI fixtures in indoor applications.

It is also equipped with a relay that can control non-dimmable fixtures up to a maximum of 6A.



Zonamerica

Architect
Estudio Dovat
Arquitectos

Lighting Design
Estudio Hofstadter

Photographer
Ferrés - Cánepa

Country
Montevideo,
Uruguay

THREESIXTY

Recessed

GENERAL INFO

Circular light fixture available in four different diameters. Can be installed recessed or semi-recessed.

Ø384mm - Ø590mm - Ø870mm - Ø1150mm

LED

Circular boards

From 2017lm to 44809lm

3000K – 4000K

Ra84

Ra90 - To order this version it is necessary to add the suffix "90" at the end of the standard code.

PRODUCT EFFICACY

Up to 106lm/W

OPTICS

OPAL – UGR – OPAL+HALO – UGR+HALO

POWER SUPPLY

Electronic – DALI

Casambi control: the DALI version is fitted with special accessories.

MATERIAL

Powder coated, extruded, calendered aluminium.

OPAL Version – Opal polycarbonate screen

UGR Version – Microprismatic PMMA screen with opal diffuser filter

A fixture with a pure and simple design in four different diameters and five different installation types : recessed, semi-recessed, ceiling mounted, suspension and wall mounted. Any light fixture can be configured in various ways when accessorised with different installation elements.

Available only with direct, direct/indirect light or in a direct light version combined with a slight indirect HALO component. a solution that is particularly suitable for the ceiling mounted, wall mounted or semi-recessed versions to create a soft frame of light. Also available in UGR<19 for the two smaller diameters.

The 384 mm and 590 mm versions can also be recessed wall mounted using a special accessory outer casing.





01

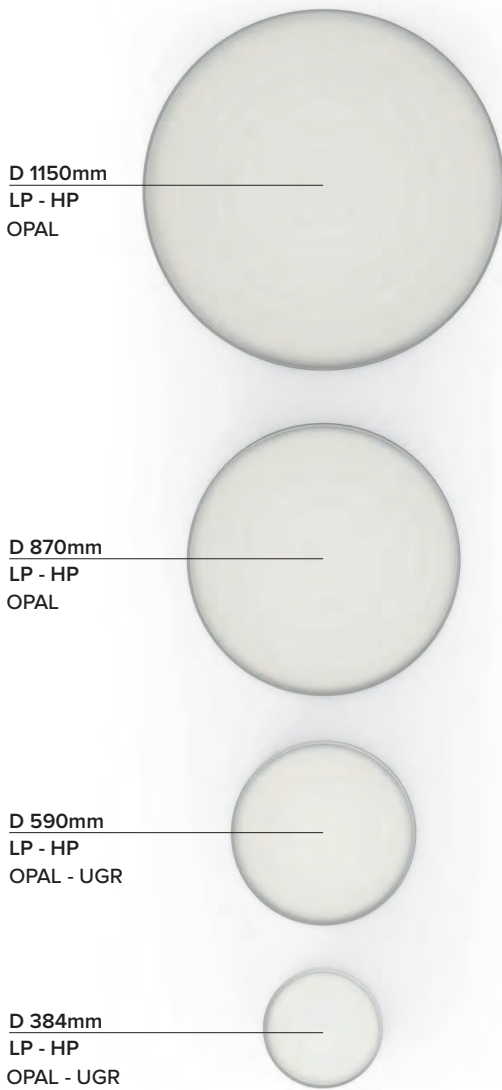

Four different diameters

To light spaces with different characteristics. Compact solutions to light environments with limited heights and large size fixtures to light great heights and showrooms.

02



A wide range of direct or direct/indirect lighting effects

Diffused light, controlled light UGR<19 and a particular Halo effect

Wall and ceiling mounted

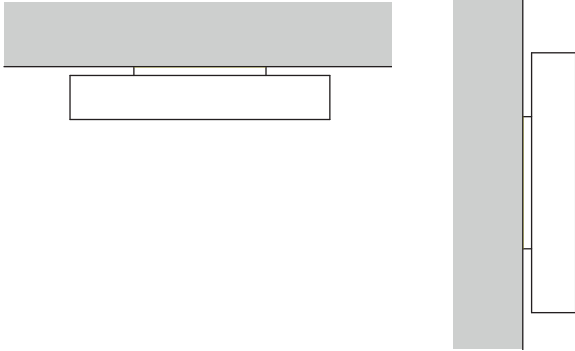

Suspension

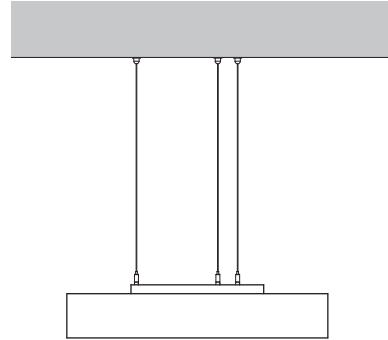

The fixture can be ceiling or wall mounted without the use of any accessories. For suspension installation a special suspension kit must be used.

Recessed - Semi Recessed

Standard frame

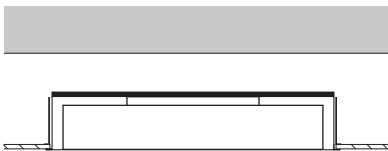

Frame HALO

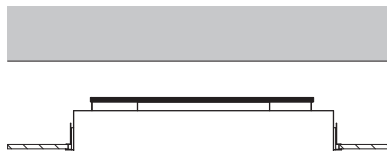

Adjustable frame

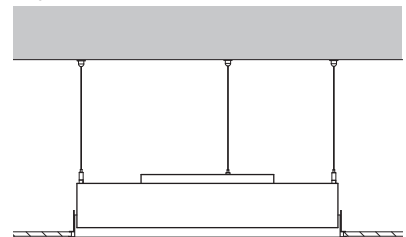

For recessed or semi-recessed installations it must be completed with special outer casings.

The 384 mm and 590 mm versions are compatible with an accessory standard or HALO version load bearing outer frame that attaches directly to the false ceiling.

The 384 mm, 590 mm, 870 mm and 1150 mm versions are compatible with a recessed non load bearing frame that attaches to the main ceiling.

THREESIXTY



Ø 384mm

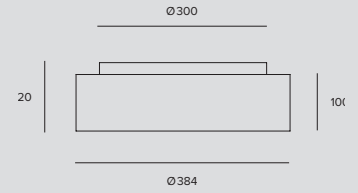

LED / 21W / DOWN OPAL

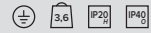

		3000K	H(m)	D(m)	E _{max} (lx)	
Ra84				114°		
Fixture Power	24W	1	3.09	636		
Source Flux	3033lm	2	6.17	159		
Fixture Flux	1836lm	3	9.26	71		
Efficacy	76lm/W	4	12.35	40		
TS1002	Imax=210cd/klm	Imax	636cd	5	15.43	25

Driver	Colour	3000K	4000K
EL.	○	1T6066EL	1T6067EL
EL.	●	1T6070EL	1T6071EL
EL.	◐	1T6068EL	1T6069EL
DALI	○	1T6066DA	1T6067DA
DALI	●	1T6070DA	1T6071DA
DALI	◐	1T6068DA	1T6069DA

LED / 29W / DOWN OPAL

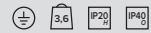

		3000K	H(m)	D(m)	E _{max} (lx)	
Ra84				114°		
Fixture Power	33W	1	3.09	848		
Source Flux	4044lm	2	6.17	212		
Fixture Flux	2448lm	3	9.26	94		
Efficacy	74lm/W	4	12.35	53		
TS1003	Imax=210cd/klm	Imax	848cd	5	15.43	34

Driver	Colour	3000K	4000K
EL.	○	1T6072EL	1T6073EL
EL.	●	1T6076EL	1T6077EL
EL.	◐	1T6074EL	1T6075EL
DALI	○	1T6072DA	1T6073DA
DALI	●	1T6076DA	1T6077DA
DALI	◐	1T6074DA	1T6075DA

LED / 13W / DOWN UGR

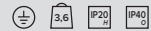

		3000K	H(m)	D(m)	E _{max} (lx)	
Ra84				92°		
Fixture Power	15W	1	2.07	702		
Source Flux	2017lm	2	4.15	176		
Fixture Flux	1458lm	3	6.22	78		
Efficacy	97lm/W	4	8.29	44		
TS1018	Imax=348cd/klm	Imax	702cd	5	10.36	28

Driver	Colour	3000K	4000K
EL.	○	1T6102EL	1T6103EL
EL.	●	1T6106EL	1T6107EL
EL.	◐	1T6104EL	1T6105EL
DALI	○	1T6102DA	1T6103DA
DALI	●	1T6106DA	1T6107DA
DALI	◐	1T6104DA	1T6105DA

LED / 35W (40,5W fixture power) / OPAL + HALO



		3000K	H(m)	D(m)	E _{max} (lx)	
Ra84				114°		
Fixture Power	24W	1	3.09	636		
Source Flux	3033lm	2	6.17	159		
Fixture Flux	1836lm	3	9.26	71		
Efficacy	76lm/W	4	12.35	40		
TS1002	Imax=210cd/klm	Imax	636cd	5	15.43	25

Driver	Colour	3000K	4000K
EL.	○	1T6078EL	1T6079EL
EL.	●	1T6082EL	1T6083EL
EL.	◐	1T6080EL	1T6081EL
DALI	○	1T6078DA	1T6079DA
DALI	●	1T6082DA	1T6083DA
DALI	◐	1T6080DA	1T6081DA

LED / 43W (49,5W fixture power) / OPAL + HALO

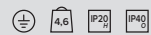

		3000K	H(m)	D(m)	E _{max} (lx)	
Ra84				114°		
Fixture Power	33W	1	3.09	848		
Source Flux	4044lm	2	6.17	212		
Fixture Flux	2448lm	3	9.26	94		
Efficacy	74lm/W	4	12.35	53		
TS1003	Imax=210cd/klm	Imax	848cd	5	15.43	34

Driver	Colour	3000K	4000K
EL.	○	1T6084EL	1T6085EL
EL.	●	1T6088EL	1T6089EL
EL.	◐	1T6086EL	1T6087EL
DALI	○	1T6084DA	1T6085DA
DALI	●	1T6088DA	1T6089DA
DALI	◐	1T6086DA	1T6087DA

LED / 27W (31,5W fixture power) / UGR + HALO ⊕ 4,6 IP20 IP40

		3000K	H(m)	D(m)	E _{max} (lx)
Ra84				92°	
Fixture Power	15W	1	2.07	702	
Source Flux	2017lm	2	4.15	176	
Fixture Flux	1458lm	3	6.22	78	
Efficacy	97lm/W	4	8.29	44	
TS1018	Imax=348cd/klm Imax	702cd	5	10.36	28

Driver	Colour	3000K	4000K
EL.	○	1T6114EL	1T6115EL
EL.	●	1T6118EL	1T6119EL
EL.	◐	1T6116EL	1T6117EL
DALI	○	1T6114DA	1T6115DA
DALI	●	1T6118DA	1T6119DA
DALI	◐	1T6116DA	1T6117DA

Note

HALO Version: for the photometric curve please see the direct version. Indirect emission with the HALO effect is purely decorative and its effect depends on the type of installation.

Check mounting instructions to verify the quantity of DALI drivers installed.

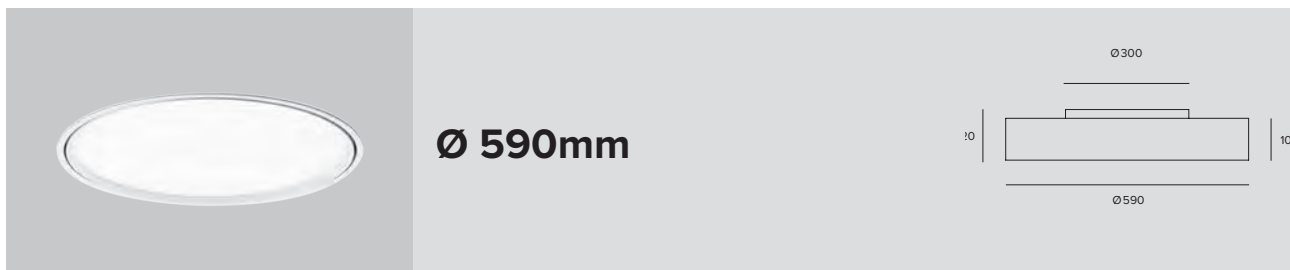

LED / 50W / DOWN OPAL ⊕ 7,2 IP20 IP40

		3000K	H(m)	D(m)	E _{max} (lx)
Ra84				114°	
Fixture Power	57W	1	3.09	1555	
Source Flux	7418lm	2	6.17	389	
Fixture Flux	4490lm	3	9.26	173	
Efficacy	79lm/W	4	12.35	97	
TS1002	Imax=210cd/klm Imax	1555cd	5	15.43	62

Driver	Colour	3000K	4000K
EL.	○	1T6138EL	1T6139EL
EL.	●	1T6142EL	1T6143EL
EL.	◐	1T6140EL	1T6141EL
DALI	○	1T6138DA	1T6139DA
DALI	●	1T6142DA	1T6143DA
DALI	◐	1T6140DA	1T6141DA

LED / 67W / DOWN OPAL ⊕ 7,2 IP20 IP40

		3000K	H(m)	D(m)	E _{max} (lx)
Ra84				114°	
Fixture Power	75W	1	3.09	2079	
Source Flux	9917lm	2	6.17	520	
Fixture Flux	6003lm	3	9.26	231	
Efficacy	80lm/W	4	12.35	130	
TS1003	Imax=210cd/klm Imax	2079cd	5	15.43	83

Driver	Colour	3000K	4000K
EL.	○	1T6144EL	1T6145EL
EL.	●	1T6148EL	1T6149EL
EL.	◐	1T6146EL	1T6147EL
DALI	○	1T6144DA	1T6145DA
DALI	●	1T6148DA	1T6149DA
DALI	◐	1T6146DA	1T6147DA

LED / 31W / DOWN UGR ⊕ 7,2 IP20 IP40

		3000K	H(m)	D(m)	E _{max} (lx)
Ra84				92°	
Fixture Power	35W	1	2.07	1722	
Source Flux	4944lm	2	4.15	430	
Fixture Flux	3575lm	3	6.22	191	
Efficacy	102lm/W	4	8.29	108	
TS1019	Imax=348cd/klm Imax	1722cd	5	10.36	69

Driver	Colour	3000K	4000K
EL.	○	1T6174EL	1T6175EL
EL.	●	1T6178EL	1T6179EL
EL.	◐	1T6176EL	1T6177EL
DALI	○	1T6174DA	1T6175DA
DALI	●	1T6178DA	1T6179DA
DALI	◐	1T6176DA	1T6177DA

THREESIXTY

LED / 70W (81W fixture power) / OPAL + HALO

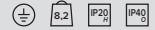

3000K		H(m)	D(m)	E _{max} (lx)
Ra84		114°		
Fixture Power	57W	1	3.09	1555
Source Flux	7418lm	2	6.17	389
Fixture Flux	4490lm	3	9.26	173
Efficacy	79lm/W	4	12.35	97
TS1002	<i>l</i> _{max} =210cd/klm	<i>l</i> _{max}	1555cd	5
			15.43	62

Driver	Colour	3000K	4000K
EL.	○	1T6150EL	1T6151EL
EL.	●	1T6154EL	1T6155EL
EL.	●	1T6152EL	1T6153EL
DALI	○	1T6150DA	1T6151DA
DALI	●	1T6154DA	1T6155DA
DALI	●	1T6152DA	1T6153DA

LED / 87W (99W fixture power) / OPAL + HALO



3000K		H(m)	D(m)	E _{max} (lx)
Ra84		114°		
Fixture Power	75W	1	3.09	2079
Source Flux	9917lm	2	6.17	520
Fixture Flux	6003lm	3	9.26	231
Efficacy	80lm/W	4	12.35	130
TS1003	<i>l</i> _{max} =210cd/klm	<i>l</i> _{max}	2079cd	5
			15.43	83

Driver	Colour	3000K	4000K
EL.	○	1T6156EL	1T6157EL
EL.	●	1T6160EL	1T6161EL
EL.	●	1T6158EL	1T6159EL
DALI	○	1T6156DA	1T6157DA
DALI	●	1T6160DA	1T6161DA
DALI	●	1T6158DA	1T6159DA

LED / 51W (59W fixture power) / UGR + HALO

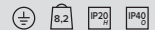

3000K		H(m)	D(m)	E _{max} (lx)
Ra84		92°		
Fixture Power	35W	1	2.07	1722
Source Flux	4944lm	2	4.15	430
Fixture Flux	3575lm	3	6.22	191
Efficacy	102lm/W	4	8.29	108
TS1019	<i>l</i> _{max} =348cd/klm	<i>l</i> _{max}	1722cd	5
			10.36	69

Driver	Colour	3000K	4000K
EL.	○	1T6186EL	1T6187EL
EL.	●	1T6190EL	1T6191EL
EL.	●	1T6188EL	1T6189EL
DALI	○	1T6186DA	1T6187DA
DALI	●	1T6190DA	1T6191DA
DALI	●	1T6188DA	1T6189DA

Note

HALO Version: for the photometric curve please see the direct version. Indirect emission with the HALO effect is purely decorative and its effect depends on the type of installation.

Check mounting instructions to verify the quantity of DALI drivers installed.



Ø 870mm

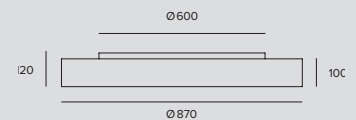

LED / 113W / DOWN OPAL

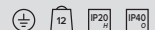

3000K		H(m)	D(m)	E _{max} (lx)
Ra84		114°		
Fixture Power	127W	1	3.09	3404
Source Flux	16238lm	2	6.17	851
Fixture Flux	9829lm	3	9.26	378
Efficacy	77lm/W	4	12.35	213
TS1002	<i>l</i> _{max} =210cd/klm	<i>l</i> _{max}	3404cd	5
			15.43	136

Driver	Colour	3000K	4000K
EL.	○	1T6210EL	1T6211EL
EL.	●	1T6214EL	1T6215EL
EL.	●	1T6212EL	1T6213EL
DALI	○	1T6210DA	1T6211DA
DALI	●	1T6214DA	1T6215DA
DALI	●	1T6212DA	1T6213DA

LED / 144W / DOWN OPAL ⊥ 12 IP20 IP40

		3000K	H(m)	D(m)	E _{max} (lx)	
Ra84				114*		
Fixture Power	162W	1	3.09	4548		
Source Flux	21693lm	2	6.17	1137		
Fixture Flux	13131lm	3	9.26	505		
Efficacy	81lm/W	4	12.35	284		
TS1003	Imax=210cd/klm	Imax	4548cd	5	15.43	182

Driver	Colour	3000K	4000K
EL.	○	1T6216EL	1T6217EL
EL.	●	1T6220EL	1T6221EL
EL.	◐	1T6218EL	1T6219EL
DALI	○	1T6216DA	1T6217DA
DALI	●	1T6220DA	1T6221DA
DALI	◐	1T6218DA	1T6219DA

LED / 138W (160W fixture power) / OPAL + HALO ⊥ 13 IP20 IP40

		3000K	H(m)	D(m)	E _{max} (lx)	
Ra84				114*		
Fixture Power	127W	1	3.09	3404		
Source Flux	16238lm	2	6.17	851		
Fixture Flux	9829lm	3	9.26	378		
Efficacy	77lm/W	4	12.35	213		
TS1002	Imax=210cd/klm	Imax	3404cd	5	15.43	136

Driver	Colour	3000K	4000K
EL.	○	1T6222EL	1T6223EL
EL.	●	1T6226EL	1T6225EL
EL.	◐	1T6224EL	1T6225EL
DALI	○	1T6222DA	1T6223DA
DALI	●	1T6226DA	1T6227DA
DALI	◐	1T6224DA	1T6225DA

LED / 174W (201W fixture power) / OPAL + HALO ⊥ 13 IP20 IP40

		3000K	H(m)	D(m)	E _{max} (lx)	
Ra84				114*		
Fixture Power	162W	1	3.09	4548		
Source Flux	21693lm	2	6.17	1137		
Fixture Flux	13131lm	3	9.26	505		
Efficacy	81lm/W	4	12.35	284		
TS1003	Imax=210cd/klm	Imax	4548cd	5	15.43	182

Driver	Colour	3000K	4000K
EL.	○	1T6228EL	1T6229EL
EL.	●	1T6232EL	1T6233EL
EL.	◐	1T6230EL	1T6231EL
DALI	○	1T6228DA	1T6229DA
DALI	●	1T6232DA	1T6233DA
DALI	◐	1T6230DA	1T6231DA

Note

HALO Version: for the photometric curve please see the direct version. Indirect emission with the HALO effect is purely decorative and its effect depends on the type of installation.

Check mounting instructions to verify the quantity of DALI drivers installed.

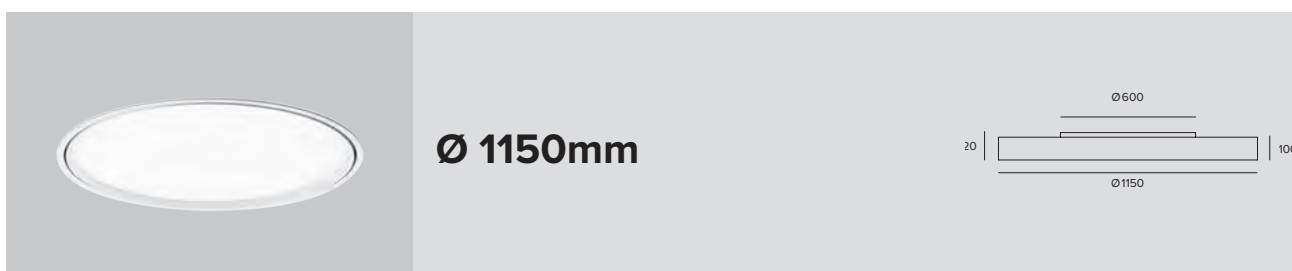



LED / 182W / DOWN OPAL ⊥ 23 IP20 IP40

		3000K	H(m)	D(m)	E _{max} (lx)	
Ra84				114*		
Fixture Power	204W	1	3.09	5760		
Source Flux	27475lm	2	6.17	1440		
Fixture Flux	16631lm	3	9.26	640		
Efficacy	82lm/W	4	12.35	360		
TS1002	Imax=210cd/klm	Imax	5760cd	5	15.43	230

Driver	Colour	3000K	4000K
EL.	○	1T6246EL	1T6247EL
EL.	●	1T6250EL	1T6251EL
EL.	◐	1T6248EL	1T6249EL
DALI	○	1T6246DA	1T6247DA
DALI	●	1T6250DA	1T6251DA
DALI	◐	1T6248DA	1T6249DA

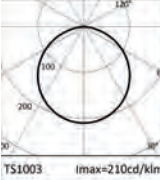
THREESIXTY

LED / 243W / DOWN OPAL												
	3000K	H(m)	D(m)	Emax(lx)	Driver	Colour	3000K	4000K				
	Ra84		114*		EL.	○	1T6252EL	1T6253EL				
	Fixture Power	273W	1	3.09	7695	EL.	●	1T6256EL	1T6257EL			
	Source Flux	36705lm	2	6.17	1924	EL.	●	1T6254EL	1T6255EL			
	Fixture Flux	22218lm	3	9.26	855	DALI	○	1T6252DA	1T6253DA			
	Efficacy	81lm/W	4	12.35	481	DALI	●	1T6256DA	1T6257DA			
TS1003	imax=210cd/klm	imax	7695cd	5	15.43	308			DALI	●	1T6254DA	1T6255DA

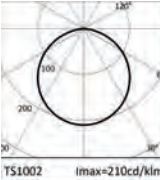
LED / 226W (258W fixture power) / OPAL + HALO												
	3000K	H(m)	D(m)	Emax(lx)	Driver	Colour	3000K	4000K				
	Ra84		114*		EL.	○	1T6258EL	1T6259EL				
	Fixture Power	204W	1	3.09	5760	EL.	●	1T6262EL	1T6263EL			
	Source Flux	27475lm	2	6.17	1440	EL.	●	1T6260EL	1T6261EL			
	Fixture Flux	16631lm	3	9.26	640	DALI	○	1T6258DA	1T6259DA			
	Efficacy	82lm/W	4	12.35	360	DALI	●	1T6262DA	1T6263DA			
TS1002	imax=210cd/klm	imax	5760cd	5	15.43	230			DALI	●	1T6260DA	1T6261DA

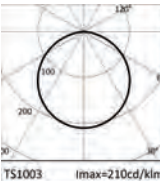
LED / 286W (325W fixture power) / OPAL + HALO												
	3000K	H(m)	D(m)	Emax(lx)	Driver	Colour	3000K	4000K				
	Ra84		114*		EL.	○	1T6264EL	1T6265EL				
	Fixture Power	273W	1	3.09	7695	EL.	●	1T6268EL	1T6269EL			
	Source Flux	36705lm	2	6.17	1924	EL.	●	1T6266EL	1T6267EL			
	Fixture Flux	22218lm	3	9.26	855	DALI	○	1T6264DA	1T6265DA			
	Efficacy	81lm/W	4	12.35	481	DALI	●	1T6268DA	1T6269DA			
TS1003	imax=210cd/klm	imax	7695cd	5	15.43	308			DALI	●	1T6266DA	1T6267DA

Note

HALO Version: for the photometric curve please see the direct version. Indirect emission with the HALO effect is purely decorative and its effect depends on the type of installation.

Check mounting instructions to verify the quantity of DALI drivers installed.

Related codes

Insertion Box

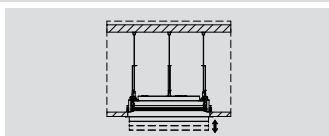

Cutout hole	Ø	Colour	Code
Ø410	421	○	1T6291
Ø410	421	●	1T6292
Ø410	421	●	1T6293
Ø615	627	○	1T6294
Ø615	627	●	1T6295
Ø615	627	●	1T6296
Ø895	907	○	1T6297
Ø895	907	●	1T6298
Ø895	907	●	1T6299
Ø1175	1187	○	1T6300
Ø1175	1187	●	1T6301
Ø1175	1187	●	1T6302

Adjustable frame for semi or completely recessed installation.
 Non load bearing frame compatible with all sizes.
 Powder coated, extruded, calendered aluminium body.
 The outer casing attaches to the ceiling with pre-galvanised steel brackets.
 The fixture must then be fixed to the ceiling using a suspension cable with an ABS control system installed in the outer casing.

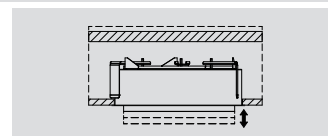
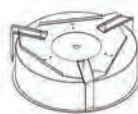

Cutout hole	Ø	Colour	Code
Ø450	460	○	1T6401
Ø450	460	●	1T6402
Ø450	460	●	1T6403
Ø660	670	○	1T6404
Ø660	670	●	1T6405
Ø660	670	●	1T6406

Casing for semi or completely recessed installation.
 Load bearing outer casing measuring 384mm and 590mm.
 Powder coated, spun aluminium body.
 The outer casing attaches to the ceiling with pre-galvanised steel brackets.
 Halo Version.

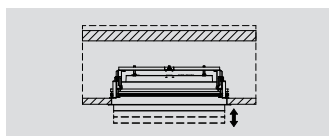

Cutout hole	Ø	Colour	Code
Ø410	421	○	1T6303
Ø410	421	●	1T6304
Ø410	421	●	1T6305
Ø615	627	○	1T6306
Ø615	627	●	1T6307
Ø615	627	●	1T6308

Frame for semi or completely recessed installation.
 Load bearing outer frame measuring 384mm and 590mm.
 Powder coated, extruded, calendered aluminium body.
 The outer frame attaches to the ceiling with pre-galvanised steel brackets.
 Standard Version.

Accessories

Control systems

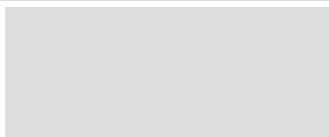

Code

1T5349

Wireless control unit for DALI fixtures.
 It generates a local DALI bus that can control individual fixtures.
 The module can be connected to an existing DALI network.
 The module is wireless controlled using a Casambi app for smartphones and tablets using Bluetooth 4.0 technology.
 The devices create a wireless mesh network that can control up to 128 fixtures.
 IP20.

Code

1T5352

IP20 Extender for wireless control of DALI fixtures.
 It generates a local DALI bus with the capacity to drive up to 64 fixtures.
 Can control DALI fixtures in indoor applications.
 It is also equipped with a relay that can control non-dimmable fixtures up to a maximum of 6A.





CCTLED Downlight

GENERAL INFO

LED recessed Classic and trimless downlight.

CCT LED Ø175mm

CCT LED MINI Ø120mm

CCT LED MICRO Ø80mm

LED

Chip on board

From 1798lm to 4462lm

2700K (excluding the MINI and MICRO version)

3000K – 4000K

Ra84

Ra90 - To order this version it is necessary to add the suffix "90" at the end of the standard code (excluding the MICRO and SMART HE version).

Ra97 only for selected codes

PRODUCT EFFICACY

Up to 144lm/W

OPTICS

SMART HE – TECH – FEEL – DEEP

WALL WASHER

SP - FL - WFL

POWER SUPPLY

Electronic – DALI

1-10V only for Ø175mm version

Emergency kit available as an accessory.

Casambi control: the DALI version is fitted with special accessories.

MATERIAL

Die-cast aluminium white painted for the recessed trimless versions, black painted die-cast aluminium for the recessed ring versions.

CCTLED is the range of LED products with various applications and optical solutions. Available in three different sizes - CCTLED, CCTLED Mini AND CCTLED Micro - they have the same design and colour consistency of the source to provide coordinated solutions for different project needs.

Also available with optics that are suitable for offices (UGR<19) and a classic ring or trimless finish for complete integration into the architecture.





Boston Logan Airport Terminal B

Lighting Design
Collaborative
LIGHTING, LLC

Country
Boston - USA

01
CCTLED



A complete range to light any environment

From offices where visual comfort is indispensable to common spaces where it is necessary to combine performance with excellent light quality.

Smart High Efficacy versions available

Equipped with high performance LED lamps, they achieve an efficiency equal to 144 lm/W.

02
CCTLED Mini

03
CCTLED Micro



A wide range of
performance

And optical possibilities while keeping the same design and colour constancy between the various LED lamps allows for great freedom of design.

3 sizes, 5 power
supplies and 7
different optical
solutions

Provide the same family feeling.

04
CCTLED



SMART optic

The ideal solution for diffused and perfectly homogeneous general lighting. Its soft light is the result of the combination between the particular geometry of the reflector and the micro-prismatic dome refractor that shields the LED lamp distributing the light in a soft and diffused way.

05
CCTLED



TECH optic

It can be installed not only in all those environments that are governed by EN12464-1 regulations relating to limits on direct glare, but also in spaces with high or double volume ceilings where light control is critical to ensure good illumination values, precision and visual comfort. The first reflector emits light in an efficient and controlled way; the second creates a luminous ring that enhances the overall effect.

06 CCTLED



Ottica FEEL

A technical solution for an effective, comfortable light, in line with EN 12464-1 (UGR<19) regulations. The highly sophisticated optical system works on reflection, hiding the lamp from sight for maximum visual comfort.

07 CCTLED



Wall Washer optic

It is ideal for lighting up large vertical surfaces. A 120 cm spacing between each fixture is sufficient to provide a completely uniform effect.

CCTLED DOWNLIGHT



Smart HE Facetted

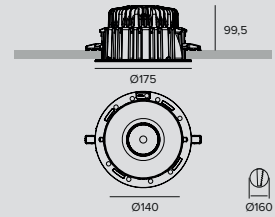

LED / 17W / FACETTED / VWFL



	3000K	H(m)	D(m)	E _{max} (lx)		
	Ra84			81°		
	Fixture Power	19W	1	1.71	1559	
	Source Flux	3003lm	2	3.42	390	
	Fixture Flux	2591lm	3	5.14	173	
	Efficacy	136lm/W	4	6.85	97	
TS1100	I _{max} =596cd/klm	I _{max}	1789cd	5	8.56	62

Driver	2700K	3000K	4000K
EL.	1T6995EL	1T6979EL	1T6980EL
1-10V	1T6995D	1T6979D	1T6980D
DALI	1T6995DA	1T6979DA	1T6980DA

LED / 23W / FACETTED / VWFL



	3000K	H(m)	D(m)	E _{max} (lx)		
	Ra84			81°		
	Fixture Power	26W	1	1.71	2136	
	Source Flux	4114lm	2	3.42	534	
	Fixture Flux	3549lm	3	5.14	237	
	Efficacy	137lm/W	4	6.85	133	
TS1100	I _{max} =596cd/klm	I _{max}	2451cd	5	8.56	85

Driver	2700K	3000K	4000K
EL.	1T6996EL	1T6981EL	1T6982EL
1-10V	1T6996D	1T6981D	1T6982D
DALI	1T6996DA	1T6981DA	1T6982DA



Smart HE Matt

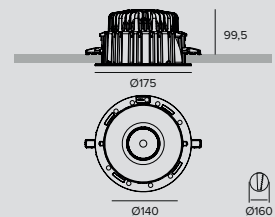

LED / 17W / MATT / VWFL



	3000K	H(m)	D(m)	E _{max} (lx)		
	Ra84			85°		
	Fixture Power	19W	1	1.83	1486	
	Source Flux	3003lm	2	3.66	371	
	Fixture Flux	2459lm	3	5.49	165	
	Efficacy	130lm/W	4	7.32	93	
TS1101	I _{max} =495cd/klm	I _{max}	1486cd	5	9.15	59

Driver	2700K	3000K	4000K
EL.	1T6997EL	1T6983EL	1T6984EL
1-10V	1T6997D	1T6983D	1T6984D
DALI	1T6997DA	1T6983DA	1T6984DA

LED / 23W / MATT / VWFL



	3000K	H(m)	D(m)	E _{max} (lx)		
	Ra84			85°		
	Fixture Power	26W	1	1.83	2036	
	Source Flux	4114lm	2	3.66	509	
	Fixture Flux	3382lm	3	5.49	226	
	Efficacy	130lm/W	4	7.32	127	
TS1101	I _{max} =495cd/klm	I _{max}	2036cd	5	9.15	81

Driver	2700K	3000K	4000K
EL.	1T6998EL	1T6985EL	1T6986EL
1-10V	1T6998D	1T6985D	1T6986D
DALI	1T6998DA	1T6985DA	1T6986DA

Related codes

Decorative Ring

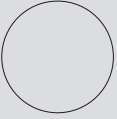
		180
Ø	Colour	Code
180	○	1T2933
180	●	1T3529

Round ring.

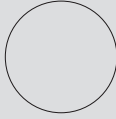
		180
Ø	Colour	Code
180	○	1T2935
180	●	1T3530

Square ring.

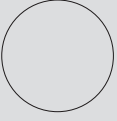
		180
Ø	Colour	Code
180	○	1T2939

Square ring with external silk screen printed screen.
IP43.

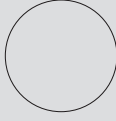
		180
Ø	Colour	Code
180	○	1T3035

Square ring with micro prismatic diffusive screen.
IP43.

Plaster

		Cutout hole	Code
		Ø367	1T4213

Plaster ring for installation in false ceilings.
To be completed with a decorative ring.

CCTLED DOWNLIGHT



Tech Secondary faceted

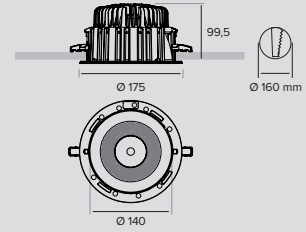

LED / 15W / SECONDARY FACETTED / WFL



	3000K	H(m)	D(m)	Emax(lx)	
	Ra84		70°		
	Fixture Power	17W	1	1.39	1689
	Source Flux	2520lm	2	2.78	422
	Fixture Flux	2070lm	3	4.16	188
	Efficacy	120lm/W	4	5.55	106

TS660 I_{max}=721cd/klm I_{max} 1817cd 5 6.94 68

Driver	2700K	3000K	4000K
EL.	1T3256EL	1T2921EL	1T2922EL
1-10V	1T3256D	1T2921D	1T2922D
DALI	1T3256DA	1T2921DA	1T2922DA

LED / 21W / SECONDARY FACETTED / WFL



	3000K	H(m)	D(m)	Emax(lx)	
	Ra84		70°		
	Fixture Power	24W	1	1.39	2172
	Source Flux	3240lm	2	2.78	543
	Fixture Flux	2662lm	3	4.16	241
	Efficacy	111lm/W	4	5.55	136

TS655 I_{max}=721cd/klm I_{max} 2336cd 5 6.94 87

Driver	2700K	3000K	4000K
EL.	1T3257EL	1T2923EL	1T2924EL
1-10V	1T3257D	1T2923D	1T2924D
DALI	1T3257DA	1T2923DA	1T2924DA



Tech Secondary matt

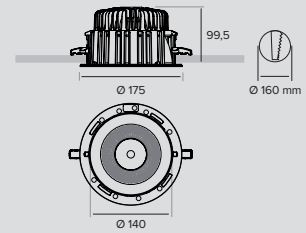

LED / 15W / SECONDARY MATT / WFL



	3000K	H(m)	D(m)	Emax(lx)	
	Ra84		69°		
	Fixture Power	17W	1	1.38	1679
	Source Flux	2520lm	2	2.77	420
	Fixture Flux	2070lm	3	4.15	187
	Efficacy	120lm/W	4	5.54	105

TS659 I_{max}=733cd/klm I_{max} 1847cd 5 6.92 67

Driver	2700K	3000K	4000K
EL.	1T3258EL	1T2925EL	1T2926EL
1-10V	1T3258D	1T2925D	1T2926D
DALI	1T3258DA	1T2925DA	1T2926DA

LED / 21W / SECONDARY MATT / WFL



	3000K	H(m)	D(m)	Emax(lx)	
	Ra84		69°		
	Fixture Power	24W	1	1.38	2159
	Source Flux	3240lm	2	2.77	540
	Fixture Flux	2662lm	3	4.15	240
	Efficacy	111lm/W	4	5.54	135

TS656 I_{max}=733cd/klm I_{max} 2375cd 5 6.92 86

Driver	2700K	3000K	4000K
EL.	1T3259EL	1T2927EL	1T2928EL
1-10V	1T3259D	1T2927D	1T2928D
DALI	1T3259DA	1T2927DA	1T2928DA

Related codes

Decorative Ring



Ø	Colour	Code
180	○	1T2933
180	●	1T3529

Round ring.



Ø	Colour	Code
180	○	1T2934
180	●	1T3531

XL ring.

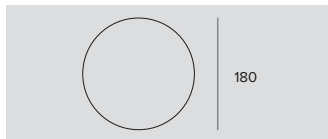

Ø	Colour	Code
180	○	1T2935
180	●	1T3530

Square ring.

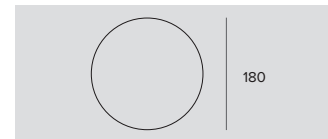

Ø	Colour	Code
180	○	1T2939

Square ring with external silk screen printed screen.
IP43.

Plaster

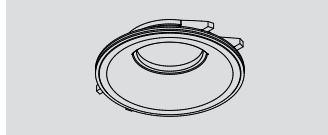

Cutout hole	Code
Ø367	1T4213

Plaster ring for installation in false ceilings.
To be completed with a decorative ring.

CCTLED DOWNLIGHT



Feel Facetted

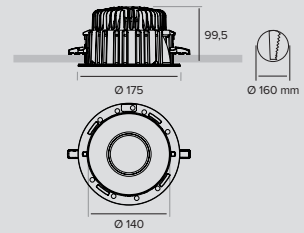

LED / 14W / FACETTED / VWFL



	3000K	H(m)	D(m)	Emax(lx)		
	Ra84			73°		
	Fixture Power	15W	1	1.48	967	
	Source Flux	2269lm	2	2.96	242	
	Fixture Flux	1423lm	3	4.44	107	
	Efficacy	93lm/W	4	5.92	60	
TS662	Imax=501cd/klm	Imax	1137cd	5	7.40	39

Driver	2700K	3000K	4000K
EL.	1T3260EL	1T2929EL	1T2930EL
1-10V	1T3260D	1T2929D	1T2930D
DALI	1T3260DA	1T2929DA	1T2930DA



Feel Matt

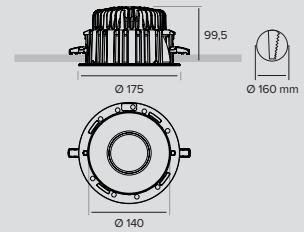

LED / 14W / MATT / WFL



	3000K	H(m)	D(m)	Emax(lx)		
	Ra84			70°		
	Fixture Power	15W	1	1.41	898	
	Source Flux	2269lm	2	2.82	225	
	Fixture Flux	1268lm	3	4.23	100	
	Efficacy	83lm/W	4	5.64	56	
TS663	Imax=415cd/klm	Imax	941cd	5	7.05	36

Driver	2700K	3000K	4000K
EL.	1T3261EL	1T2931EL	1T2932EL
1-10V	1T3261D	1T2931D	1T2932D
DALI	1T3261DA	1T2931DA	1T2932DA

Related codes

Decorative Ring

		180		
	Ø	Colour	Code	
	180	○	1T2933	
	180	●	1T3529	

Round ring.

		180		
	Ø	Colour	Code	
	180	○	1T2935	
	180	●	1T3530	

Square ring.

		180		
	Ø	Colour	Code	
	180	○	1T2939	

Square ring with external silk screen printed screen.
IP43.

Plaster

	Cutout hole	Code		
	Ø367	1T4213		

Plaster ring for installation in false ceilings.
To be completed with a decorative ring.



Deep

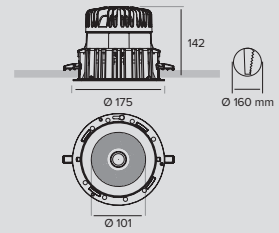

LED / 33W / SP								
	3000K	H(m)	D(m)	Emax(lx)	Driver	3000K	4000K	
	Ra84			21°	EL.	1T3157EL	1T3158EL	
	Fixture Power	36W	1	0.36	24354	1-10V	1T3157D	1T3158D
	Source Flux	4351lm	2	0.72	6089	DALI	1T3157DA	1T3158DA
	Fixture Flux	3457lm	3	1.09	2706			
	Efficacy	97lm/W	4	1.45	1522			
TS708	Imax=5597cd/klm	Imax	24354cd	5	1.81	974		

LED / 33W / FL								
	3000K	H(m)	D(m)	Emax(lx)	Driver	3000K	4000K	
	Ra84			33°	EL.	1T3159EL	1T3160EL	
	Fixture Power	36W	1	0.59	10995	1-10V	1T3159D	1T3160D
	Source Flux	4351lm	2	1.18	2749	DALI	1T3159DA	1T3160DA
	Fixture Flux	3378lm	3	1.78	1222			
	Efficacy	95lm/W	4	2.37	687			
TS709	Imax=2537cd/klm	Imax	11039cd	5	2.96	440		

Related codes

Decorative Ring			
		180	
	Ø	Colour	Code
	180	○	1T2933
	180	●	1T3529
		180	
	Ø	Colour	Code
	180	○	1T2935
	180	●	1T3530

Round ring.

Square ring.

		180	
	Ø	Colour	Code
	180	○	1T2939

Square ring with external silk screen printed screen.
IP43.

Plaster	
	Cutout hole
	Code
	Ø367
	1T4213

Plaster ring for installation in false ceilings.
To be completed with a decorative ring.

Recessed

CCTLED DOWNLIGHT



Wall Washer

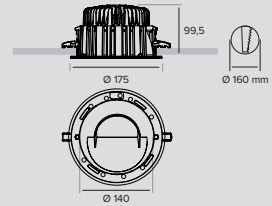

LED / 21W / WALL WASHER										
	3000K	H(m)	D1(m)	D2(m)	E _{max} (lx)	Driver	2700K	3000K	4000K	
	Ra84		78°	75°		EL.	1T3368EL	1T3369EL	1T3370EL	
	Fixture Power	24W	1	1.62	1.65	1305	1-10V	1T3368D	1T3369D	1T3370D
	Source Flux	3232lm	2	3.23	3.31	326	DALI	1T3368DA	1T3369DA	1T3370DA
	Fixture Flux	1904lm	3	4.85	4.96	145				
	Efficacy	79lm/W	4	6.46	6.61	82				
TS722	I _{max} =428cd/klm	I _{max}	1382cd	5	8.08	8.27	52			

LED / 33W / WALL WASHER										
	3000K	H(m)	D1(m)	D2(m)	E _{max} (lx)	Driver	2700K	3000K	4000K	
	Ra84		78°	75°		EL.	1T3371EL	1T3372EL	1T3373EL	
	Fixture Power	36W	1	1.62	1.65	1757	1-10V	1T3371D	1T3372D	1T3373D
	Source Flux	4351lm	2	3.23	3.31	439	DALI	1T3371DA	1T3372DA	1T3373DA
	Fixture Flux	2563lm	3	4.85	4.96	195				
	Efficacy	72lm/W	4	6.46	6.61	110				
TS723	I _{max} =428cd/klm	I _{max}	1860cd	5	8.08	8.27	70			

Related codes

Decorative Ring				Decorative Ring			
		180				180	
	Ø	Colour	Code		Ø	Colour	Code
	180	○	1T2933		180	○	1T2935
	180	●	1T3529		180	●	1T3530

Round ring.

Square ring.

Plaster	
	Cutout hole
	Code
	Ø367
	1T4213

Plaster ring for installation in false ceilings.
To be completed with a decorative ring.

Accessories

Carter

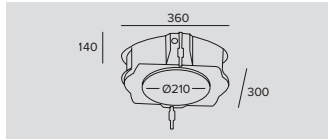

Code

1T2960

Housing for concrete installation.
Polycarbonate box to be used for installation in brick or reinforced concrete walls and ceilings.
To be completed with driver housing and a special grid.
Accessory is not compatible with the DEEP and Trimless versions.

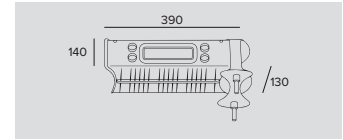

Code

1T2961

Carter for concrete installation of the external driver.
Polycarbonate box to house the external driver to be used together with the carter for concrete installation in brick or reinforced concrete ceilings and walls.
Accessory is not compatible with the DEEP and Trimless versions.

Installation grid

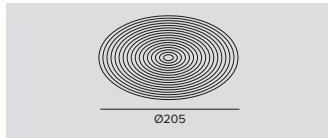

Code

1T2962

Installation grid.
White polycarbonate radial grid for installation of the fixture in the dedicated carter.
The special ring shape of the grid allows for simple and safe plastering of the fixture.
Accessory is not compatible with the DEEP and Trimless versions.

IP Kit



Ø

Code

180

1T2937

IP54 ring.
Square ring with transparent screen.
Accessories not compatible with Trimless versions.

Insertion Ring

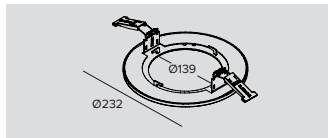

Code

1T3725

Retrofit kit for CCTLed Classic.
White polycarbonate outer ring with bayonet locking system.
Outer ring suitable for recessed holes of between 190 and 215mm.
The accessory is not compatible with the decorative rings available for CCTLed.
Accessories not compatible with Trimless versions.

Emergency Kit



Code

1T3144

Emergency kit.
Inverter + 3h battery pack.
For CCTLED Architectural Mini: no NSP version.
IP20.

Control systems



Code

1T5349

Wireless control unit for DALI fixtures.
It generates a local DALI bus that can control individual fixtures.
The module can be connected to an existing DALI network.
The module is wireless controlled using a Casambi app for smartphones and tablets using Bluetooth 4.0 technology.
The devices create a wireless mesh network that can control up to 128 fixtures.
IP20.



Code

1T5352

IP20 Extender for wireless control of DALI fixtures.
It generates a local DALI bus with the capacity to drive up to 64 fixtures.
Can control DALI fixtures in indoor applications.
It is also equipped with a relay that can control non-dimmable fixtures up to a maximum of 6A.

CCTLED DOWNLIGHT



Smart HE Trimless Facetted

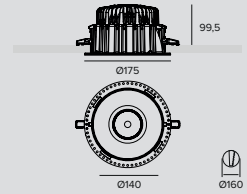

LED / 17W / FACETTED / VWFL



	3000K	H(m)	D(m)	Emax(lx)		
	Ra84		81°			
	Fixture Power	19W	1	1.71	1559	
	Source Flux	3003lm	2	3.42	390	
	Fixture Flux	2591lm	3	5.14	173	
	Efficacy	136lm/W	4	6.85	97	
TS1100	Imax=596cd/klm	Imax	1789cd	5	8.56	62

Driver	Colour	2700K	3000K	4000K
EL.	○	1T6999EL	1T6987EL	1T6988EL
1-10V	○	1T6999D	1T6987D	1T6988D
DALI	○	1T6999DA	1T6987DA	1T6988DA

LED / 23W / FACETTED / VWFL



	3000K	H(m)	D(m)	Emax(lx)		
	Ra84		81°			
	Fixture Power	26W	1	1.71	2136	
	Source Flux	4114lm	2	3.42	534	
	Fixture Flux	3549lm	3	5.14	237	
	Efficacy	137lm/W	4	6.85	133	
TS1100	Imax=596cd/klm	Imax	2451cd	5	8.56	85

Driver	Colour	2700K	3000K	4000K
EL.	○	1T7000EL	1T6989EL	1T6990EL
1-10V	○	1T7000D	1T6989D	1T6990D
DALI	○	1T7000DA	1T6989DA	1T6990DA



Smart HE Trimless Matt

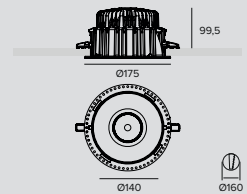

LED / 17W / MATT / VWFL



	3000K	H(m)	D(m)	Emax(lx)		
	Ra84		85°			
	Fixture Power	19W	1	1.83	1486	
	Source Flux	3003lm	2	3.66	371	
	Fixture Flux	2459lm	3	5.49	165	
	Efficacy	130lm/W	4	7.32	93	
TS1101	Imax=495cd/klm	Imax	1486cd	5	9.15	59

Driver	Colour	2700K	3000K	4000K
EL.	○	1T7001EL	1T6991EL	1T6992EL
1-10V	○	1T7001D	1T6991D	1T6992D
DALI	○	1T7001DA	1T6991DA	1T6992DA

LED / 23W / MATT / VWFL



	3000K	H(m)	D(m)	Emax(lx)		
	Ra84		85°			
	Fixture Power	26W	1	1.83	2036	
	Source Flux	4114lm	2	3.66	509	
	Fixture Flux	3382lm	3	5.49	226	
	Efficacy	130lm/W	4	7.32	127	
TS1101	Imax=495cd/klm	Imax	2036cd	5	9.15	81

Driver	Colour	2700K	3000K	4000K
EL.	○	1T7002EL	1T6993EL	1T6994EL
1-10V	○	1T7002D	1T6993D	1T6994D
DALI	○	1T7002DA	1T6993DA	1T6994DA



Tech Trimless Secondary faceted

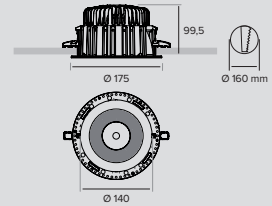

LED / 15W / SECONDARY FACETTED / WFL



	3000K	H(m)	D(m)	Emax(lx)	
	Ra84		70°		
	Fixture Power	17W	1	1.39	1689
	Source Flux	2520lm	2	2.78	422
	Fixture Flux	2070lm	3	4.16	188
	Efficacy	120lm/W	4	5.55	106

TS660 I_{max}=721cd/klm I_{max} 1817cd 5 6.94 68

Driver	Colour	2700K	3000K	4000K
EL.	○	1T3266EL	1T2948EL	1T2949EL
1-10V	○	1T3266D	1T2948D	1T2949D
DALI	○	1T3266DA	1T2948DA	1T2949DA

LED / 21W / SECONDARY FACETTED / WFL



	3000K	H(m)	D(m)	Emax(lx)	
	Ra84		70°		
	Fixture Power	24W	1	1.39	2172
	Source Flux	3240lm	2	2.78	543
	Fixture Flux	2662lm	3	4.16	241
	Efficacy	111lm/W	4	5.55	136

TS655 I_{max}=721cd/klm I_{max} 2336cd 5 6.94 87

Driver	Colour	2700K	3000K	4000K
EL.	○	1T3267EL	1T2950EL	1T2951EL
1-10V	○	1T3267D	1T2950D	1T2951D
DALI	○	1T3267DA	1T2950DA	1T2951DA



Tech Trimless Secondary matt

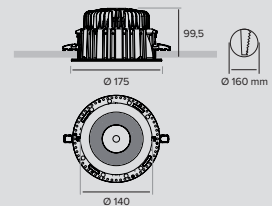

LED / 15W / SECONDARY MATT / WFL



	3000K	H(m)	D(m)	Emax(lx)	
	Ra84		69°		
	Fixture Power	17W	1	1.38	1679
	Source Flux	2520lm	2	2.77	420
	Fixture Flux	2070lm	3	4.15	187
	Efficacy	120lm/W	4	5.54	105

TS659 I_{max}=733cd/klm I_{max} 1847cd 5 6.92 67

Driver	Colour	2700K	3000K	4000K
EL.	○	1T3268EL	1T2952EL	1T2953EL
1-10V	○	1T3268D	1T2952D	1T2953D
DALI	○	1T3268DA	1T2952DA	1T2953DA

LED / 21W / SECONDARY MATT / WFL



	3000K	H(m)	D(m)	Emax(lx)	
	Ra84		69°		
	Fixture Power	24W	1	1.38	2159
	Source Flux	3240lm	2	2.77	540
	Fixture Flux	2662lm	3	4.15	240
	Efficacy	111lm/W	4	5.54	135

TS656 I_{max}=733cd/klm I_{max} 2375cd 5 6.92 86

Driver	Colour	2700K	3000K	4000K
EL.	○	1T3269EL	1T2954EL	1T2955EL
1-10V	○	1T3269D	1T2954D	1T2955D
DALI	○	1T3269DA	1T2954DA	1T2955DA

CCTLED DOWNLIGHT



Feel Trimless Facetted

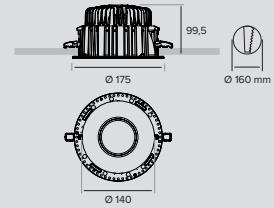

LED / 14W / FACETTED / VWFL



	3000K	H(m)	D(m)	Emax(lx)		
	Ra84		73°			
	Fixture Power	15W	1	1.48	967	
	Source Flux	2269lm	2	2.96	242	
	Fixture Flux	1423lm	3	4.44	107	
	Efficacy	93lm/W	4	5.92	60	
TS662	Imax=501cd/klm	Imax	1137cd	5	7.40	39

Driver	Colour	2700K	3000K	4000K
EL.	○	1T3270EL	1T2956EL	1T2957EL
1-10V	○	1T3270D	1T2956D	1T2957D
DALI	○	1T3270DA	1T2956DA	1T2957DA



Feel Trimless Matt

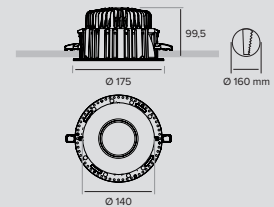

LED / 14W / MATT / WFL



	3000K	H(m)	D(m)	Emax(lx)		
	Ra84		70°			
	Fixture Power	15W	1	1.41	898	
	Source Flux	2269lm	2	2.82	225	
	Fixture Flux	1268lm	3	4.23	100	
	Efficacy	83lm/W	4	5.64	56	
TS663	Imax=415cd/klm	Imax	941cd	5	7.05	36

Driver	Colour	2700K	3000K	4000K
EL.	○	1T3271EL	1T2958EL	1T2959EL
1-10V	○	1T3271D	1T2958D	1T2959D
DALI	○	1T3271DA	1T2958DA	1T2959DA



Wall Washer Trimless

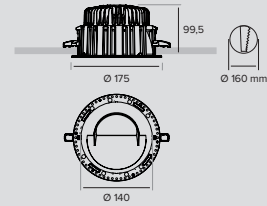

LED / 21W / WALL WASHER											
	3000K	H(m)	D1(m)	D2(m)	E _{max} (lx)	Driver	Colour	2700K	3000K	4000K	
	Ra84		78°	75°		EL.	○	1T3374EL	1T3375EL	1T3376EL	
	Fixture Power	24W	1	1.62	1.65	1305	1-10V	○	1T3374D	1T3375D	1T3376D
	Source Flux	3232lm	2	3.23	3.31	326	DALI	○	1T3374DA	1T3375DA	1T3376DA
	Fixture Flux	1904lm	3	4.85	4.96	145					
	Efficacy	79lm/W	4	6.46	6.61	82					
TS722	I _{max} =428cd/klm	I _{max}	1382cd	5	8.08	8.27	52				

LED / 33W / WALL WASHER											
	3000K	H(m)	D1(m)	D2(m)	E _{max} (lx)	Driver	Colour	2700K	3000K	4000K	
	Ra84		78°	75°		EL.	○	1T3377EL	1T3378EL	1T3379EL	
	Fixture Power	36W	1	1.62	1.65	1757	1-10V	○	1T3377D	1T3378D	1T3379D
	Source Flux	4351lm	2	3.23	3.31	439	DALI	○	1T3377DA	1T3378DA	1T3379DA
	Fixture Flux	2563lm	3	4.85	4.96	195					
	Efficacy	72lm/W	4	6.46	6.61	110					
TS723	I _{max} =428cd/klm	I _{max}	1860cd	5	8.08	8.27	70				

Accessories

Emergency Kit	
	Code
	1T3144

Emergency kit.
 Inverter + 3h battery pack.
 For CCTLED Architectural Mini: no NSP version.
 IP20.

Control systems	
	Code
	1T5349
	Code
	1T5352

Wireless control unit for DALI fixtures.
 It generates a local DALI bus that can control individual fixtures.
 The module can be connected to an existing DALI network.
 The module is wireless controlled using a Casambi app for smartphones and tablets using Bluetooth 4.0 technology.
 The devices create a wireless mesh network that can control up to 128 fixtures.
 IP20.

IP20 Extender for wireless control of DALI fixtures.
 It generates a local DALI bus with the capacity to drive up to 64 fixtures.
 Can control DALI fixtures in indoor applications.
 It is also equipped with a relay that can control non-dimmable fixtures up to a maximum of 6A.

CCTLED DOWNLIGHT



**Mini
standard - trimless**

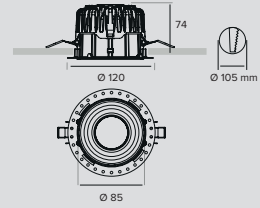

LED / 12W / MATT / WFL								
	3000K	H(m)	D(m)	Emax(lx)	Driver	3000K	4000K	
	Ra84		75°		EL.	1T4821EL	1T4822EL	
	Fixture Power	14W	1	1.54	1211	DALI	1T4821DA	1T4822DA
	Source Flux	1971lm	2	3.08	303			
	Fixture Flux	1516lm	3	4.62	135			
Efficiency	112lm/W	4	6.16	76				
TS908	Imax=615cd/klm	Imax	1211cd	5	7.70	48.		

LED / 17W / MATT / WFL								
	3000K	H(m)	D(m)	Emax(lx)	Driver	3000K	4000K	
	Ra84		75°		EL.	1T4823EL	1T4824EL	
	Fixture Power	19W	1	1.54	1650	DALI	1T4823DA	1T4824DA
	Source Flux	2684lm	2	3.08	412			
	Fixture Flux	2064lm	3	4.62	183			
Efficiency	107lm/W	4	6.16	103				
TS908	Imax=615cd/klm	Imax	1650cd	5	7.70	66		



**Mini Wall Washer
standard - trimless**

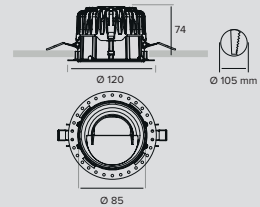

LED / 12W / WALL WASHER									
	3000K	H(m)	D1(m)	D2(m)	Emax(lx)	Driver	3000K	4000K	
	Ra84		68°	70°		EL.	1T4825EL	1T4826EL	
	Fixture Power	14W	1	1.34	1.59	765	DALI	1T4825DA	1T4826DA
	Source Flux	1971lm	2	2.68	3.18	191			
	Fixture Flux	1064lm	3	4.02	4.77	85			
Efficiency	79lm/W	4	5.36	6.35	48				
TS909	Imax=397cd/klm	Imax	783cd	5	6.70	7.94	31		

LED / 17W / WALL WASHER									
	3000K	H(m)	D1(m)	D2(m)	Emax(lx)	Driver	3000K	4000K	
	Ra84		68°	70°		EL.	1T4827EL	1T4828EL	
	Fixture Power	19W	1	1.34	1.59	1042	DALI	1T4827DA	1T4828DA
	Source Flux	2684lm	2	2.68	3.18	261			
	Fixture Flux	1449lm	3	4.02	4.77	116			
Efficiency	75lm/W	4	5.36	6.35	65				
TS909	Imax=397cd/klm	Imax	1067cd	5	6.70	7.94	42		

Accessories

Insertion Ring



Cutout hole	Colour	Code
Ø125	○	1T5242
Ø125	●	1T5243
Ø125	●	1T5244

Accessory for trimless inspectable installation.
Secondary reflector.

Decorative Ring

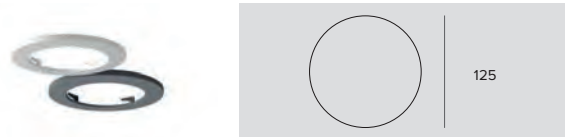

Ø	Colour	Code
125	○	1T4696
125	●	1T4697

Round ring.

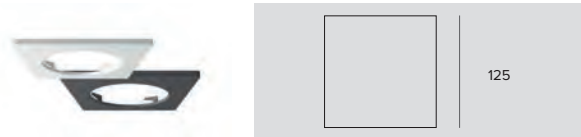

L	Colour	Code
125	○	1T4698
125	●	1T4699

Square ring.

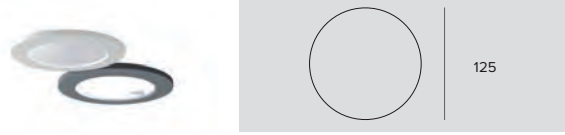

Ø	Colour	Code
125	○	1T4704
125	●	1T4705

Round ring (IP54).

Emergency Kit



Code
1T3144

Emergency kit.
Inverter + 3h battery pack.
For CCTLED Architectural Mini: no NSP version.
IP20.

Control systems



Code
1T5349

Wireless control unit for DALI fixtures.
It generates a local DALI bus that can control individual fixtures.
The module can be connected to an existing DALI network.
The module is wireless controlled using a Casambi app for smartphones and tablets using Bluetooth 4.0 technology.
The devices create a wireless mesh network that can control up to 128 fixtures.
IP20.



Code
1T5352

IP20 Extender for wireless control of DALI fixtures.
It generates a local DALI bus with the capacity to drive up to 64 fixtures.
Can control DALI fixtures in indoor applications.
It is also equipped with a relay that can control non-dimmable fixtures up to a maximum of 6A.

CCTLED DOWNLIGHT



Micro

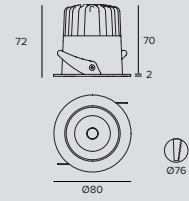

LED / 12W / WFL



	3000K	H(m)	D(m)	E _{max} (lx)
Ra84			55°	
Fixture Power	14W	1	1.03	1708
Source Flux	1798lm	2	2.06	427
Fixture Flux	1354lm	3	3.10	190
Efficacy	97lm/W	4	4.13	107
TS1043	Imax=950cd/klm	Imax	1708cd	5 5.16 68

Power supply	Colour	3000K	4000K
350mA	○	1T6373	1T6374
350mA	●	1T6375	1T6376

Related codes

Power Supply

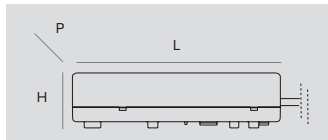

Code

1T6503

Electronic power supply max 15W, LxHxP=101.5x29.5x51mm, 220-240V-AC 50-60Hz, 350mA, IP20.

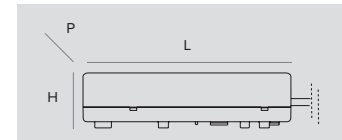

Code

1T6504

DALI dimmable electronic power supply max 15W, LxHxP=146.5x30x44mm, 220-240V-AC 50-60Hz, 350mA, IP20.

Accessories

Emergency Kit

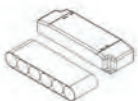

Code

1T3144

Emergency kit.
Inverter + 3h battery pack.
For CCTLED Architectural Mini: no NSP version.
IP20.

Control systems



Code

1T5349

Wireless control unit for DALI fixtures.
It generates a local DALI bus that can control individual fixtures.
The module can be connected to an existing DALI network.
The module is wireless controlled using a Casambi app for smartphones and tablets using Bluetooth 4.0 technology.
The devices create a wireless mesh network that can control up to 128 fixtures.
IP20.



Code

1T5352

IP20 Extender for wireless control of DALI fixtures.
It generates a local DALI bus with the capacity to drive up to 64 fixtures.
Can control DALI fixtures in indoor applications.
It is also equipped with a relay that can control non-dimmable fixtures up to a maximum of 6A.

CCT Flash LED

GENERAL INFO

Recessed downlight
CCTLED Ø225mm

LED

COB Chip on board
From 2342lm to 2403lm
3000K – 4000K
Ra84

PRODUCT EFFICACY

Up to 104lm/W

OPTICS

VWFL

POWER SUPPLY

Electronic - DALI
Casambi control: the DALI version is fitted with special accessories.

MATERIAL

Body and ring in white polycarbonate.

Recessed LED fixture that combines high performance and excellent light distribution. Quick and easy to install, with a high efficiency soft light.

Perfect retrofit of fluorescent versions with a cutout hole 215mm diameter.





LED

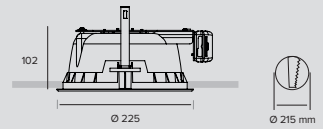

LED / 17W / VWFL									
	3000K	H(m)	D(m)	Emax(lx)		Driver	Colour	3000K	4000K
	Ra84		79°			EL.	○	1T4304	1T4305
	Fixture Power	19W	1	1.65	1313	DALI	○	1T4304DA	1T4305DA
	Source Flux	2342lm	2	3.30	328				
	Fixture Flux	1956lm	3	4.95	146				
	Efficacy	101lm/W	4	6.60	82				
T5854	Imax=560cd/klm	Imax	1313cd	5	8.26	53			

Accessories

Diffuser

Code
47282

Decorative cylindrical component made of transparent sandblasted polycarbonate.

Screen

Code
1T1173

Polycarbonate IP44 screen, transparent in the centre.
Cannot be mounted together with the decorative metal ring.

Code
1T1245

Polycarbonate IP44 screen, sandblasted in the centre.
Cannot be mounted together with the decorative metal ring.

Glass

Code
47293

Tempered flush mounted IP24 glass, silk screen printed in the centre.
IP44 protection degree is obtained by combining the decorative ring, made of polycarbonate, and the borosilicate glass.

Code
47294

Tempered flush mounted IP24 glass, sandblasted in the centre.
IP44 protection degree is obtained by combining the decorative ring, made of polycarbonate, and the borosilicate glass.

CCT FLASH



Code

47291

Tempered protruding IP44 glass, silk screen printed at the centre.



Code

47292

Tempered protruding IP44 glass, sandblasted at the centre.

Mounting System



L	Ø	Code
290	212	47382
390	212	47385

Plate for plank ceiling mounting.
The plates with a side measurement of 290mm can be installed on planks with a 300 or 100mm opening and take up the space of 1 or 3 components, respectively.
The plates with a side measurement of 390mm can be installed on planks with a 200mm opening and take up the space of 2 components.

IP Kit

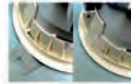

Code

1T2418

IP54 Kit. Silicone sealing kit for round ring.
The IP54 degree of protection is obtained by combining the silicone kit with the protective screens IP44.

Decorative Ring



Colour	Code
○	47274

Decorative ring made of polycarbonate.
IP44 protection degree is obtained by combining the decorative ring, made of polycarbonate, and the borosilicate glass.



Colour	Code
Chrome	54091
Aluminium	54091L
Brushed steel	1T1463

Decorative ring made of metal.
It can only be used with flush glass.

Emergency Kit

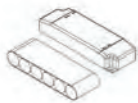

Code

1T3144

Emergency kit.
Inverter + 3h battery pack.
For CCTLED Architectural Mini: no NSP version.
IP20.

Control systems



Code

1T5349

Wireless control unit for DALI fixtures.
It generates a local DALI bus that can control individual fixtures.
The module can be connected to an existing DALI network.
The module is wireless controlled using a Casambi app for smartphones and tablets using Bluetooth 4.0 technology.
The devices create a wireless mesh network that can control up to 128 fixtures.
IP20.



Code

1T5352

IP20 Extender for wireless control of DALI fixtures.
It generates a local DALI bus with the capacity to drive up to 64 fixtures.
Can control DALI fixtures in indoor applications.
It is also equipped with a relay that can control non-dimmable fixtures up to a maximum of 6A.

CCTLED

Architectural

GENERAL INFO

Fixed and Adjustable recessed projectors
 CCTLED Ø175mm
 CCTLED MINI Ø120mm
 CCTLED MICRO Ø80mm

LED

Chip on board
 From 200lm to 8749lm
 2700K – 3000K – 4000K
 Ra84
 Ra90 - To order this version it is necessary to add the suffix "90" at the end of the standard code.
 Ra97 on selected codes.
 MINI GU10 version LED lamps not included.

PRODUCT EFFICACY

Up to 120lm/W

OPTICS

NSP – SP – FL – MWFL – WFL
 DBS - Digital beam opening control
 SP – FL – WFL for only MICRO version

POWER SUPPLY

Electronic – DALI
 1-10V per only Ø175mm version.
 Emergency kit available as an accessory.
 Casambi control: DBS version Casambi on board. DALI version is fitted with special accessories.

MATERIAL

Black painted die-cast aluminium body for the ring version, white painted for the trimless versions.
 Adjustable 355° in the horizontal plane and 30° in the vertical plane with micrometric aiming system. Double aiming lock.

A range of recessed projectors for professional lighting from the CCTLED range. The construction, size and original heat sink are inherited from the downlight version in a low luminance projected light version designed for professional architectural lighting that meets performance, precision and versatility requirements.

Available in three different sizes - **CCTLED Architectural, Mini and Micro** - in the double fixed and adjustable version; the first two are both recessed and trimless. Also available in a DBS - Dynamic Beam Shaper- version for the ø175mm version.

		CCTLED	CCTLED HP	CCTLED MINI	CCTLED MICRO
		Ø 175mm	Ø 175mm	Ø 120mm	Ø 80mm
LED	Flux (lm)	2289-4441	8533-8749	200-2520	1798-1855
	Power	14W-33W	54W	3W-18W	12W

OPTICS

NSP	Lenticular			•	
	Hybrid	•			
SP	Lenticular			•	
	Hybrid				
	Reflector	•	•		
FL	Lenticular			•	
	Hybrid	•			
	Reflector	•	•		•
MWFL	Reflector	•		•	
WFL	Reflector	•		•	•
DBS	Changeable	•			





Chaoyang Park Plaza

Architect
Ma Yansong,
MAD Architects

Country
Beijing - China

01
CCTLED Architectural



The largest version
in the range with a
diameter of 175mm

It is available in a fixed and adjustable double version with two different finishes Classic and Trimless. The versatility of CTLED ARCHITECTURAL is given by the different optical systems that produce beams from NSP, SP, FL, MWFL and WFL. The high quality LED lamps and the wide range of power supply and control solutions make it a complete and extraordinarily efficient professional fixture.

02 CCTLED Architectural Mini



The Mini version is the most elegant solution in the range

Because it combines design flexibility and particular attention to detail. A small recessed projector that conceals its technological heart and blends in with the architecture thanks to the different aesthetic solutions available.

03 CCTLED Architectural Micro



The Micro version is the latest fixture in the range

The 12W power output versions are available with three different beam openings: SP, FL and WFL. Precision PMMA optics for high efficiency solutions with beams with soft gradient tones make it particularly suitable for example for Retail installations or in Entertainment environments. The LED lamp is retracted to ensure maximum visual comfort. With an installation depth of just 76mm and an 80mm diameter, the MICRO version has a maximum adjustability of 30° on the vertical plane.

CCTLED ARCHITECTURAL



Fixed

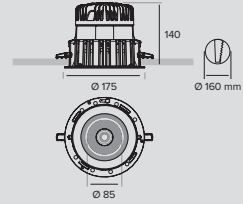

LED / 14W / HYBRID / NSP

	3000K	H(m)	D(m)	Emax(lx)	
	Ra84		10°		
	Fixture Power	18W	1	0.17	30508
	Source Flux	2055lm	2	0.34	7627
	Fixture Flux	1290lm	3	0.52	3390
	Efficacy	71lm/W	4	0.69	1907

TS920	Imax=14846cd/klm	Imax	30508cd	5	0.86	1220
-------	------------------	------	---------	---	------	------

Driver	2700K	3000K	4000K
EL.	1T4805EL	1T4801EL	1T4802EL
1-10V	1T4805D	1T4801D	1T4802D
DALI	1T4805DA	1T4801DA	1T4802DA

LED / 26W / HYBRID / FL

	3000K	H(m)	D(m)	Emax(lx)	
	Ra84		33°		
	Fixture Power	28W	1	0.58	7556
	Source Flux	3387lm	2	1.17	1889
	Fixture Flux	2067lm	3	1.75	840
	Efficacy	74lm/W	4	2.33	472

TS921	Imax=2231cd/klm	Imax	7556cd	5	2.92	302
-------	-----------------	------	--------	---	------	-----

Driver	2700K	3000K	4000K
EL.	1T4815EL	1T4811EL	1T4812EL
1-10V	1T4815D	1T4811D	1T4812D
DALI	1T4815DA	1T4811DA	1T4812DA

LED / 25W / REFLECTOR / MWFL

	3000K	H(m)	D(m)	Emax(lx)	
	Ra84		45°		
	Fixture Power	27W	1	0.82	5842
	Source Flux	3594lm	2	1.64	1460
	Fixture Flux	3123lm	3	2.46	649
	Efficacy	116lm/W	4	3.28	365

TS738	Imax=1655cd/klm	Imax	5947cd	5	4.10	234
-------	-----------------	------	--------	---	------	-----

Driver	2700K	3000K	4000K
EL.	1T3551EL	1T3114EL	1T3115EL
1-10V	1T3551D	1T3114D	1T3115D
DALI	1T3551DA	1T3114DA	1T3115DA

LED / 25W / REFLECTOR / WFL

	3000K	H(m)	D(m)	Emax(lx)	
	Ra84		59°		
	Fixture Power	27W	1	1.13	4066
	Source Flux	3594lm	2	2.26	1017
	Fixture Flux	3168lm	3	3.39	452
	Efficacy	117lm/W	4	4.51	254

TS739	Imax=1142cd/klm	Imax	4105cd	5	5.64	163
-------	-----------------	------	--------	---	------	-----

Driver	2700K	3000K	4000K
EL.	1T3553EL	1T3118EL	1T3119EL
1-10V	1T3553D	1T3118D	1T3119D
DALI	1T3553DA	1T3118DA	1T3119DA

LED / 33W / REFLECTOR / SP

	3000K	H(m)	D(m)	Emax(lx)	
	Ra84		14°		
	Fixture Power	36W	1	0.24	33910
	Source Flux	4331lm	2	0.48	8478
	Fixture Flux	3683lm	3	0.72	3768
	Efficacy	103lm/W	4	0.96	2119

TS732	Imax=7830cd/klm	Imax	33910cd	5	1.20	1356
-------	-----------------	------	---------	---	------	------

Driver	2700K	3000K	4000K
EL.	1T3548EL	1T3108EL	1T3109EL
1-10V	1T3548D	1T3108D	1T3109D
DALI	1T3548DA	1T3108DA	1T3109DA

LED / 33W / REFLECTOR / FL



		3000K	H(m)	D(m)	Emax(lx)
Ra84				28°	
Fixture Power	36W	1	0.50	12789	
Source Flux	4331lm	2	1.00	3197	
Fixture Flux	3666lm	3	1.50	1421	
Efficacy	103lm/W	4	2.00	799	
TS733	Imax=2953cd/klm	Imax	12789cd	5	2.50

Driver	2700K	3000K	4000K
EL.	1T3550EL	1T3112EL	1T3113EL
1-10V	1T3550D	1T3112D	1T3113D
DALI	1T3550DA	1T3112DA	1T3113DA

LED / 33W / REFLECTOR / MWFL



		3000K	H(m)	D(m)	Emax(lx)
Ra84				45°	
Fixture Power	36W	1	0.82	7040	
Source Flux	4331lm	2	1.64	1760	
Fixture Flux	3754lm	3	2.46	782	
Efficacy	105lm/W	4	3.28	440	
TS734	Imax=1655cd/klm	Imax	7166cd	5	4.10

Driver	2700K	3000K	4000K
EL.	1T3552EL	1T3116EL	1T3117EL
1-10V	1T3552D	1T3116D	1T3117D
DALI	1T3552DA	1T3116DA	1T3117DA

LED / 33W / REFLECTOR / WFL



		3000K	H(m)	D(m)	Emax(lx)
Ra84				59°	
Fixture Power	36W	1	1.13	4900	
Source Flux	4331lm	2	2.26	1225	
Fixture Flux	3817lm	3	3.39	544	
Efficacy	107lm/W	4	4.51	306	
TS735	Imax=1142cd/klm	Imax	4947cd	5	5.64

Driver	2700K	3000K	4000K
EL.	1T3554EL	1T3120EL	1T3121EL
1-10V	1T3554D	1T3120D	1T3121D
DALI	1T3554DA	1T3120DA	1T3121DA

LED / 26W / DBS



		3000K	H(m)	D(m)	Emax(lx)
Ra84				14°	
Fixture Power	28W	1	0.25	19042	
Source Flux	3387lm	2	0.50	4761	
Fixture Flux	1619lm	3	0.75	2116	
Efficacy	58lm/W	4	1.00	1190	
TS1102	Imax=5622cd/klm	Imax	19042cd	5	1.26

Driver	2700K	3000K	4000K
CASAMBI		1T6971CA	1T6972CA

		3000K	H(m)	D(m)	Emax(lx)
Ra84				24°	
Fixture Power	28W	1	0.43	6755	
Source Flux	3387lm	2	0.86	1689	
Fixture Flux	1575lm	3	1.29	751	
Efficacy	56lm/W	4	1.72	422	
TS1103	Imax=1994cd/klm	Imax	6755cd	5	2.15



		3000K	H(m)	D(m)	Emax(lx)
Ra84				31°	
Fixture Power	28W	1	0.56	4104	
Source Flux	3387lm	2	1.13	1026	
Fixture Flux	1525lm	3	1.69	456	
Efficacy	54lm/W	4	2.25	256	
TS1104	Imax=1212cd/klm	Imax	4104cd	5	2.82

		3000K	H(m)	D(m)	Emax(lx)
Ra84				45°	
Fixture Power	28W	1	0.83	1955	
Source Flux	3387lm	2	1.67	489	
Fixture Flux	1338lm	3	2.50	217	
Efficacy	48lm/W	4	3.34	122	
TS1105	Imax=577cd/klm	Imax	1955cd	5	4.17

CCTLED ARCHITECTURAL



Related codes

Decorative Ring

Ø	Colour	Code
180	○	1T2933
180	●	1T3529

Round ring.

Ø	Colour	Code
180	○	1T2935
180	●	1T3530

Square ring.

Plaster



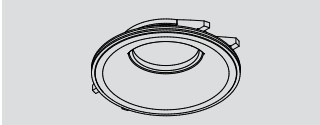

Cutout hole	Code
Ø367	1T4213

Plaster ring for installation in false ceilings.
To be completed with a decorative ring.

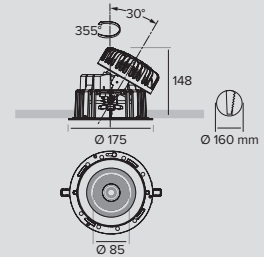

Adjustable



LED / 14W / HYBRID / NSP / CR184



3000K	H(m)	D(m)	Emax(lx)
Ra84			
Fixture Power	18W	1	0.17 30508
Source Flux	2055lm	2	0.34 7627
Fixture Flux	1290lm	3	0.52 3390
Efficacy	71lm/W	4	0.69 1907
TS920	imax=14846cd/klm	imax	30508cd 5 0.86 1220

Driver	2700K	3000K	4000K
EL.	1T4806EL	1T4797EL	1T4798EL
1-10V	1T4806D	1T4797D	1T4798D
DALI	1T4806DA	1T4797DA	1T4798DA

LED / 26W / HYBRID / FL / CR184



3000K	H(m)	D(m)	Emax(lx)
Ra84			
Fixture Power	28W	1	0.58 7556
Source Flux	3387lm	2	1.17 1889
Fixture Flux	2067lm	3	1.75 840
Efficacy	74lm/W	4	2.33 472
TS921	imax=2231cd/klm	imax	7556cd 5 2.92 302

Driver	2700K	3000K	4000K
EL.	1T4816EL	1T4819EL	1T4820EL
1-10V	1T4816D	1T4819D	1T4820D
DALI	1T4816DA	1T4819DA	1T4820DA

LED / 25W / REFLECTOR / MWFL / CR184



3000K	H(m)	D(m)	Emax(lx)
Ra84			
Fixture Power	27W	1	0.82 5842
Source Flux	3594lm	2	1.64 1460
Fixture Flux	3123lm	3	2.46 649
Efficacy	116lm/W	4	3.28 365
TS738	imax=1655cd/klm	imax	5947cd 5 4.10 234

Driver	2700K	3000K	4000K
EL.	1T3559EL	1T3082EL	1T3083EL
1-10V	1T3559D	1T3082D	1T3083D
DALI	1T3559DA	1T3082DA	1T3083DA

LED / 25W / REFLECTOR / WFL / CRI84



		3000K	H(m)	D(m)	Emax(lx)
		Ra84			59°
Fixture Power	27W	1	1.13	4066	
Source Flux	3594lm	2	2.26	1017	
Fixture Flux	3168lm	3	3.39	452	
Efficacy	117lm/W	4	4.51	254	
TS739	Imax=1142cd/klm	Imax	4105cd	5	5.64
				163	

Driver	2700K	3000K	4000K
EL.	1T3561EL	1T3086EL	1T3087EL
1-10V	1T3561D	1T3086D	1T3087D
DALI	1T3561DA	1T3086DA	1T3087DA

LED / 33W / REFLECTOR / SP / CRI84



		3000K	H(m)	D(m)	Emax(lx)
		Ra84			14°
Fixture Power	36W	1	0.24	33910	
Source Flux	4331lm	2	0.48	8478	
Fixture Flux	3683lm	3	0.72	3768	
Efficacy	103lm/W	4	0.96	2119	
TS732	Imax=7830cd/klm	Imax	33910cd	5	1.20
				1356	

Driver	2700K	3000K	4000K
EL.	1T3556EL	1T3076EL	1T3077EL
1-10V	1T3556D	1T3076D	1T3077D
DALI	1T3556DA	1T3076DA	1T3077DA

LED / 33W / REFLECTOR / SP / CRI97



		3000K	H(m)	D(m)	Emax(lx)
		Ra97			14°
Fixture Power	36W	1	0.24	26089	
Source Flux	3332lm	2	0.48	6522	
Fixture Flux	2834lm	3	0.72	2899	
Efficacy	79lm/W	4	0.96	1631	
TS732	Imax=7830cd/klm	Imax	26089cd	5	1.20
				1044	

Driver	2700K	3000K	4000K
EL.		1T4264EL	
1-10V		1T4264D	
DALI		1T4264DA	

LED / 33W / REFLECTOR / FL / CRI84



		3000K	H(m)	D(m)	Emax(lx)
		Ra84			28°
Fixture Power	36W	1	0.50	12789	
Source Flux	4331lm	2	1.00	3197	
Fixture Flux	3666lm	3	1.50	1421	
Efficacy	103lm/W	4	2.00	799	
TS733	Imax=2953cd/klm	Imax	12789cd	5	2.50
				512	

Driver	2700K	3000K	4000K
EL.	1T3558EL	1T3080EL	1T3081EL
1-10V	1T3558D	1T3080D	1T3081D
DALI	1T3558DA	1T3080DA	1T3081DA

LED / 33W / REFLECTOR / FL / CRI97



		3000K	H(m)	D(m)	Emax(lx)
		Ra97			28°
Fixture Power	36W	1	0.50	9839	
Source Flux	3332lm	2	1.00	2460	
Fixture Flux	2820lm	3	1.50	1093	
Efficacy	79lm/W	4	2.00	615	
TS733	Imax=2953cd/klm	Imax	9839cd	5	2.50
				394	

Driver	2700K	3000K	4000K
EL.		1T4266EL	
1-10V		1T4266D	
DALI		1T4266DA	

LED / 33W / REFLECTOR / MWFL / CRI84



		3000K	H(m)	D(m)	Emax(lx)
		Ra84			45°
Fixture Power	36W	1	0.82	7040	
Source Flux	4331lm	2	1.64	1760	
Fixture Flux	3764lm	3	2.46	782	
Efficacy	105lm/W	4	3.28	440	
TS734	Imax=1655cd/klm	Imax	7166cd	5	4.10
				282	

Driver	2700K	3000K	4000K
EL.	1T3560EL	1T3084EL	1T3085EL
1-10V	1T3560D	1T3084D	1T3085D
DALI	1T3560DA	1T3084DA	1T3085DA

LED / 33W / REFLECTOR / MWFL / CRI97



		3000K	H(m)	D(m)	Emax(lx)
		Ra97			45°
Fixture Power	36W	1	0.82	5416	
Source Flux	3332lm	2	1.64	1354	
Fixture Flux	2895lm	3	2.46	602	
Efficacy	81lm/W	4	3.28	338	
TS734	Imax=1655cd/klm	Imax	5513cd	5	4.10
				217	

Driver	2700K	3000K	4000K
EL.		1T4268EL	
1-10V		1T4268D	
DALI		1T4268DA	

CCTLED ARCHITECTURAL

LED / 33W / REFLECTOR / WFL / CRI84 □ 1.6 IP20 IP23 ENEC

	3000K	H(m)	D(m)	E _{max} (lx)
	Ra84		59°	
Fixture Power	36W	1	1.13	4900
Source Flux	4331lm	2	2.26	1225
Fixture Flux	3817lm	3	3.39	544
Efficacy	107lm/W	4	4.51	306
TS735	I _{max} =1142cd/klm	I _{max}	4947cd	5, 5.64, 196

Driver	2700K	3000K	4000K
EL.	1T3562EL	1T3088EL	1T3089EL
1-10V	1T3562D	1T3088D	1T3089D
DALI	1T3562DA	1T3088DA	1T3089DA

LED / 33W / REFLECTOR / WFL / CRI97 □ 1.6 IP20 IP23 ENEC

	3000K	H(m)	D(m)	E _{max} (lx)
	Ra97		59°	
Fixture Power	36W	1	1.13	3770
Source Flux	3332lm	2	2.26	942
Fixture Flux	2937lm	3	3.39	419
Efficacy	82lm/W	4	4.51	236
TS735	I _{max} =1142cd/klm	I _{max}	3806cd	5, 5.64, 151

Driver	2700K	3000K	4000K
EL.		1T4270EL	
1-10V		1T4270D	
DALI		1T4270DA	

LED / 26W / DBS / CRI84 □ 1.7 IP20 IP23

	3000K	H(m)	D(m)	E _{max} (lx)
	Ra84		14°	
Fixture Power	28W	1	0.25	19042
Source Flux	3387lm	2	0.50	4761
Fixture Flux	1619lm	3	0.75	2116
Efficacy	58lm/W	4	1.00	1190
TS1102	I _{max} =5622cd/klm	I _{max}	19042cd	5, 1.26, 762

Driver	2700K	3000K	4000K
CASAMBI		1T6975CA	1T6976CA

	3000K	H(m)	D(m)	E _{max} (lx)
	Ra84		24°	
Fixture Power	28W	1	0.43	6755
Source Flux	3387lm	2	0.86	1689
Fixture Flux	1575lm	3	1.29	751
Efficacy	56lm/W	4	1.72	422
TS1103	I _{max} =1994cd/klm	I _{max}	6755cd	5, 2.15, 270

	3000K	H(m)	D(m)	E _{max} (lx)
	Ra84		31°	
Fixture Power	28W	1	0.56	4104
Source Flux	3387lm	2	1.13	1026
Fixture Flux	1525lm	3	1.69	456
Efficacy	54lm/W	4	2.25	256
TS1104	I _{max} =1212cd/klm	I _{max}	4104cd	5, 2.82, 164

	3000K	H(m)	D(m)	E _{max} (lx)
	Ra84		45°	
Fixture Power	28W	1	0.83	1955
Source Flux	3387lm	2	1.67	489
Fixture Flux	1338lm	3	2.50	217
Efficacy	48lm/W	4	3.34	122
TS1105	I _{max} =577cd/klm	I _{max}	1955cd	5, 4.17, 78

Related codes

Decorative Ring

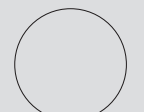
		180
	Ø	Colour
	180	○
	180	●
		Code
		1T2933
		1T3529

Round ring.

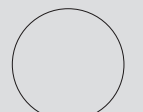
		180
	Ø	Colour
	180	○
	180	●
		Code
		1T2935
		1T3530

Square ring.

Plaster

	
	Cutout hole
	Code
	Ø367
	1T4213

Plaster ring for installation in false ceilings.
To be completed with a decorative ring.



HP Adjustable

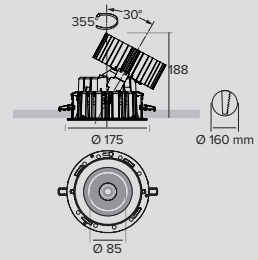

LED / 54W / REFLECTOR / SP					<input type="checkbox"/> <input type="checkbox"/> <input type="checkbox"/> <input type="checkbox"/>			
	3000K	H(m)	D(m)	Emax(lx)	Driver	3000K	4000K	
	Ra84		23°		EL.	1T4838EL	1T4839EL	
	Fixture Power	63W	1	0.41	29000	1-10V	1T4838D	1T4839D
	Source Flux	8533lm	2	0.81	7250	DALI	1T4838DA	1T4839DA
	Fixture Flux	7257lm	3	1.22	3222			
	Efficacy	115lm/W	4	1.63	1812			
TS914	Imax=3399cd/klm	Imax	29000cd	5	2.03	1160		

LED / 54W / REFLECTOR / FL					<input type="checkbox"/> <input type="checkbox"/> <input type="checkbox"/> <input type="checkbox"/>			
	3000K	H(m)	D(m)	Emax(lx)	Driver	3000K	4000K	
	Ra84		36°		EL.	1T4840EL	1T4841EL	
	Fixture Power	63W	1	0.64	17848	1-10V	1T4840D	1T4841D
	Source Flux	8533lm	2	1.29	4462	DALI	1T4840DA	1T4841DA
	Fixture Flux	7223lm	3	1.93	1983			
	Efficacy	115lm/W	4	2.58	1115			
TS915	Imax=2092cd/klm	Imax	17848cd	5	3.22	714		

Related codes

Decorative Ring			
		180	
	Ø	Colour	Code
	180	○	1T2933
	180	●	1T3529
Round ring.			
		180	
	Ø	Colour	Code
	180	○	1T2935
	180	●	1T3530
Square ring.			

Plaster	
	Cutout hole
	Code
	Ø367
	1T4213

Plaster ring for installation in false ceilings.
To be completed with a decorative ring.

CCTLED ARCHITECTURAL

Accessories

Reflector



Colour	Code
	1T3138
	1T3139
	1T3422

Secondary reflector.

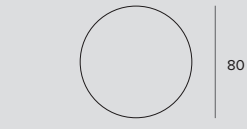

Grid

Ø	Code
80	1T3423

Anti-glare louver.
Black painted metal honeycomb structure.

Filter

Filter	Ø	Code
Red	80	1T3424
Green	80	1T3425
Blue	80	1T3426
Yellow	80	1T3427
Magenta	80	1T3428

Flat glass interference chromatic filter.

Ø	Code
80	1T3141

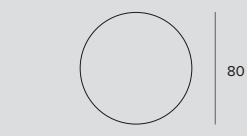
Flat glass, grooved refractive blade light filter.
This makes the beam take on an oval shape and when combined with spotlights, the light blade appears more prominent.

Ø	Code
80	1T3140

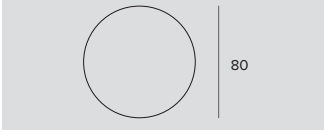
Flat glass micro prismatic refractive diffusive filter.
This softens the luminous effect.

Filter	Ø	Code
Halogen +	80	1T6382
Vivid +	80	1T6384

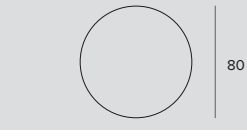
Art filter.
Flat glass interference filter that can vary the colour parameters of the emission of the fixtures it is applied to.
To be used only with 3000K and Ra80 fixtures.

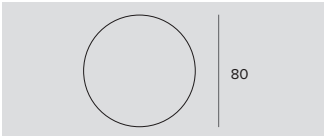

Filter	Ø	Code
Meat	80	1T6386
Fish	80	1T6388
Bread	80	1T6390
Vegetables	80	1T6392

Food filter.
Flat glass interference filter that can vary the colour parameters of the emission of the fixtures it is applied to.
1T6386
To be used only with 3000K and Ra80 fixtures.
1T6388
To be used only with 4000K and Ra80 fixtures.
1T6390
To be used only with 3000K and Ra80 fixtures.
1T6392
To be used only with 3000K and Ra80 fixtures.

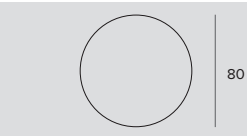



Filter	Ø	Code
Beauty	80	1T6394



Beauty filter.
Flat glass interference filter that can vary the colour parameters of the emission of the fixtures it is applied to.
To be used only with 3000K and Ra80 fixtures.

Cut-off	
	
Ø	Code
80	1T3142

Cut-off Tube.
Allows for the beam to be focused while removing the fall-off component.
No for DBS version.

Zoom	
	
Ø	Code
80	1T3432

Zoom.
Optical system consists of an optical glass flat convex lens, an anodized aluminium specular reflector and a diffusive holographic filter.
To be used after removing the existing optic.
It makes it possible to obtain a variable beam from 15° to 60°.
It can not be used with NSP and hybrid optics; no for DBS version.

IP Kit	
	
Ø	Code
180	1T2937

IP54 ring.
Square ring with transparent screen.
Accessories not compatible with Trimless versions.

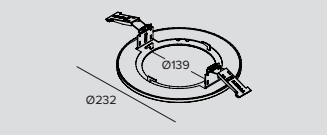
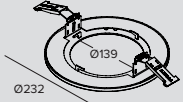
Insertion Ring	
	
	Code
	1T3725



Retrofit kit for CCTLed Classic.
White polycarbonate outer ring with bayonet locking system.
Outer ring suitable for recessed holes of between 190 and 215mm.
The accessory is not compatible with the decorative rings available for CCTLed.
Accessories not compatible with Trimless versions.

Cable	
	
	Code
	1T2833

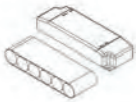
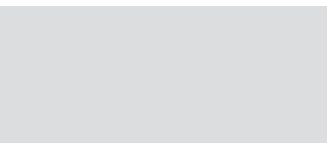
Sync cable. It synchronizes the dimming between 2 drivers.
It is possible to connect up to 10 drivers in order to maintain a uniform effect for all fixtures.

Emergency Kit	
	
	Code
	1T3144

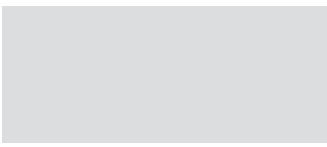
Emergency kit.
Inverter + 3h battery pack.
For CCTLED Architectural Mini: no NSP version.
IP20.

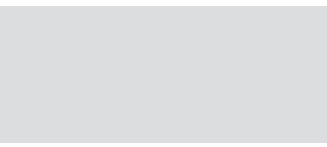
Control systems			
			
	Code		Code
	1T5349		1T5352

Wireless control unit for DALI fixtures.
It generates a local DALI bus that can control individual fixtures.
The module can be connected to an existing DALI network.
The module is wireless controlled using a Casambi app for smartphones and tablets using Bluetooth 4.0 technology.
The devices create a wireless mesh network that can control up to 128 fixtures.
IP20.

IP20 Extender for wireless control of DALI fixtures.
It generates a local DALI bus with the capacity to drive up to 64 fixtures.
Can control DALI fixtures in indoor applications.
It is also equipped with a relay that can control non-dimmable fixtures up to a maximum of 6A.

CCTLED ARCHITECTURAL



Fixed Trimless

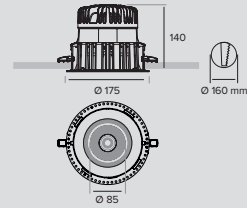

LED / 14W / HYBRID / NSP

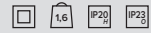

		3000K	H(m)	D(m)	E _{max} (lx)	
Ra84				10°		
Fixture Power	18W	1	0.17	30508		
Source Flux	2055lm	2	0.34	7627		
Fixture Flux	1290lm	3	0.52	3390		
Efficacy	71lm/W	4	0.69	1907		
TS920	I _{max} =14846cd/klm	I _{max}	30508cd	5	0.86	1220

Driver	Colour	2700K	3000K	4000K
EL.	○	1T4807EL	1T4803EL	1T4804EL
1-10V	○	1T4807D	1T4803D	1T4804D
DALI	○	1T4807DA	1T4803DA	1T4804DA

LED / 26W / HYBRID / FL

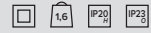

		3000K	H(m)	D(m)	E _{max} (lx)	
Ra84				33°		
Fixture Power	28W	1	0.58	7556		
Source Flux	3387lm	2	1.17	1889		
Fixture Flux	2067lm	3	1.75	840		
Efficacy	74lm/W	4	2.33	472		
TS921	I _{max} =2231cd/klm	I _{max}	7556cd	5	2.92	302

Driver	Colour	2700K	3000K	4000K
EL.	○	1T4817EL	1T4813EL	1T4814EL
1-10V	○	1T4817D	1T4813D	1T4814D
DALI	○	1T4817DA	1T4813DA	1T4814DA

LED / 25W / REFLECTOR / MWFL



		3000K	H(m)	D(m)	E _{max} (lx)	
Ra84				45°		
Fixture Power	27W	1	0.82	5842		
Source Flux	3594lm	2	1.64	1460		
Fixture Flux	3123lm	3	2.46	649		
Efficacy	116lm/W	4	3.28	365		
TS738	I _{max} =1655cd/klm	I _{max}	5947cd	5	4.10	234

Driver	Colour	2700K	3000K	4000K
EL.	○	1T3567EL	1T3130EL	1T3131EL
1-10V	○	1T3567D	1T3130D	1T3131D
DALI	○	1T3567DA	1T3130DA	1T3131DA

LED / 25W / REFLECTOR / WFL



		3000K	H(m)	D(m)	E _{max} (lx)	
Ra84				59°		
Fixture Power	27W	1	1.13	4066		
Source Flux	3594lm	2	2.26	1017		
Fixture Flux	3168lm	3	3.39	452		
Efficacy	117lm/W	4	4.51	254		
TS739	I _{max} =1142cd/klm	I _{max}	4105cd	5	5.64	163

Driver	Colour	2700K	3000K	4000K
EL.	○	1T3569EL	1T3134EL	1T3135EL
1-10V	○	1T3569D	1T3134D	1T3135D
DALI	○	1T3569DA	1T3134DA	1T3135DA

LED / 33W / REFLECTOR / SP



		3000K	H(m)	D(m)	E _{max} (lx)	
Ra84				14°		
Fixture Power	36W	1	0.24	33910		
Source Flux	4331lm	2	0.48	8478		
Fixture Flux	3683lm	3	0.72	3768		
Efficacy	103lm/W	4	0.96	2119		
TS732	I _{max} =7830cd/klm	I _{max}	33910cd	5	1.20	1356

Driver	Colour	2700K	3000K	4000K
EL.	○	1T3564EL	1T3124EL	1T3125EL
1-10V	○	1T3564D	1T3124D	1T3125D
DALI	○	1T3564DA	1T3124DA	1T3125DA

LED / 33W / REFLECTOR / FL



		3000K	H(m)	D(m)	E _{max} (lx)
		Ra84		28°	
Fixture Power	36W	1	0.50	12789	
Source Flux	4331lm	2	1.00	3197	
Fixture Flux	3666lm	3	1.50	1421	
Efficacy	103lm/W	4	2.00	799	
TS733	I _{max} =2953cd/klm	I _{max}	12789cd	5	2.50

Driver	Colour	2700K	3000K	4000K
EL.	○	1T3566EL	1T3128EL	1T3129EL
1-10V	○	1T3566D	1T3128D	1T3129D
DALI	○	1T3566DA	1T3128DA	1T3129DA

LED / 33W / REFLECTOR / MWFL

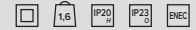

		3000K	H(m)	D(m)	E _{max} (lx)
		Ra84		45°	
Fixture Power	36W	1	0.82	7040	
Source Flux	4331lm	2	1.64	1760	
Fixture Flux	3754lm	3	2.46	782	
Efficacy	105lm/W	4	3.28	440	
TS734	I _{max} =1655cd/klm	I _{max}	7166cd	5	4.10

Driver	Colour	2700K	3000K	4000K
EL.	○	1T3568EL	1T3132EL	1T3133EL
1-10V	○	1T3568D	1T3132D	1T3133D
DALI	○	1T3568DA	1T3132DA	1T3133DA

LED / 33W / REFLECTOR / WFL



		3000K	H(m)	D(m)	E _{max} (lx)
		Ra84		59°	
Fixture Power	36W	1	1.13	4900	
Source Flux	4331lm	2	2.26	1225	
Fixture Flux	3817lm	3	3.39	544	
Efficacy	107lm/W	4	4.51	306	
TS735	I _{max} =1142cd/klm	I _{max}	4947cd	5	5.64

Driver	Colour	2700K	3000K	4000K
EL.	○	1T3570EL	1T3136EL	1T3137EL
1-10V	○	1T3570D	1T3136D	1T3137D
DALI	○	1T3570DA	1T3136DA	1T3137DA

LED / 26W / DBS



		3000K	H(m)	D(m)	E _{max} (lx)
		Ra84		14°	
Fixture Power	28W	1	0.25	19042	
Source Flux	3387lm	2	0.50	4761	
Fixture Flux	1619lm	3	0.75	2116	
Efficacy	58lm/W	4	1.00	1190	
TS1102	I _{max} =5622cd/klm	I _{max}	19042cd	5	1.26

Driver	Colour	2700K	3000K	4000K
CASAMBI	○		1T6973CA	1T6974CA

		3000K	H(m)	D(m)	E _{max} (lx)
		Ra84		24°	
Fixture Power	28W	1	0.43	6755	
Source Flux	3387lm	2	0.86	1689	
Fixture Flux	1575lm	3	1.29	751	
Efficacy	56lm/W	4	1.72	422	
TS1103	I _{max} =1994cd/klm	I _{max}	6755cd	5	2.15

		3000K	H(m)	D(m)	E _{max} (lx)
		Ra84		31°	
Fixture Power	28W	1	0.56	4104	
Source Flux	3387lm	2	1.13	1026	
Fixture Flux	1525lm	3	1.69	456	
Efficacy	54lm/W	4	2.25	256	
TS1104	I _{max} =1212cd/klm	I _{max}	4104cd	5	2.82

		3000K	H(m)	D(m)	E _{max} (lx)
		Ra84		45°	
Fixture Power	28W	1	0.83	1955	
Source Flux	3387lm	2	1.67	489	
Fixture Flux	1338lm	3	2.50	217	
Efficacy	48lm/W	4	3.34	122	
TS1105	I _{max} =577cd/klm	I _{max}	1955cd	5	4.17

CCTLED ARCHITECTURAL



Adjustable Trimless

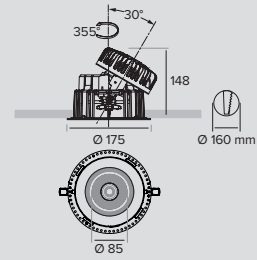

LED / 14W / HYBRID / NSP / CR184 □ 1.6 IP20_H IP23_G

		3000K	H(m)	D(m)	E _{max} (lx)
		Ra84			
		10°			
Fixture Power	18W	1	0.17	30508	
Source Flux	2055lm	2	0.34	7627	
Fixture Flux	1290lm	3	0.52	3390	
Efficacy	71lm/W	4	0.69	1907	
TS920	I _{max} =14846cd/klm	I _{max}	30508cd	5	0.86
					1220

Driver	2700K	3000K	4000K
EL.	1T4808EL	1T4799EL	1T4800EL
1-10V	1T4808D	1T4799D	1T4800D
DALI	1T4808DA	1T4799DA	1T4800DA

LED / 26W / HYBRID / FL / CR184 □ 1.6 IP20_H IP23_G

		3000K	H(m)	D(m)	E _{max} (lx)
		Ra84			
		33°			
Fixture Power	28W	1	0.58	7556	
Source Flux	3387lm	2	1.17	1889	
Fixture Flux	2067lm	3	1.75	840	
Efficacy	74lm/W	4	2.33	472	
TS921	I _{max} =2231cd/klm	I _{max}	7556cd	5	2.92
					302

Driver	2700K	3000K	4000K
EL.	1T4818EL	1T4809EL	1T4810EL
1-10V	1T4818D	1T4809D	1T4810D
DALI	1T4818DA	1T4809DA	1T4810DA

LED / 25W / REFLECTOR / MWFL / CR184 □ 1.6 IP20_H IP23_G ENEC

		3000K	H(m)	D(m)	E _{max} (lx)
		Ra84			
		45°			
Fixture Power	27W	1	0.82	5842	
Source Flux	3594lm	2	1.64	1460	
Fixture Flux	3123lm	3	2.46	649	
Efficacy	116lm/W	4	3.28	365	
TS738	I _{max} =1655cd/klm	I _{max}	5947cd	5	4.10
					234

Driver	2700K	3000K	4000K
EL.	1T3575EL	1T3098EL	1T3099EL
1-10V	1T3575D	1T3098D	1T3099D
DALI	1T3575DA	1T3098DA	1T3099DA

LED / 25W / REFLECTOR / WFL / CR184 □ 1.6 IP20_H IP23_G ENEC





		3000K	H(m)	D(m)	E _{max} (lx)
		Ra84			
		59°			
Fixture Power	27W	1	1.13	4066	
Source Flux	3594lm	2	2.26	1017	
Fixture Flux	3168lm	3	3.39	452	
Efficacy	117lm/W	4	4.51	254	
TS739	I _{max} =1142cd/klm	I _{max}	4105cd	5	5.64
					163





Driver	2700K	3000K	4000K
EL.	1T3577EL	1T3102EL	1T3103EL
1-10V	1T3577D	1T3102D	1T3103D
DALI	1T3577DA	1T3102DA	1T3103DA



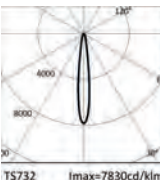

LED / 33W / REFLECTOR / SP / CR184 □ 1.6 IP20_H IP23_G ENEC



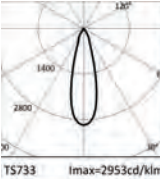

		3000K	H(m)	D(m)	E _{max} (lx)
		Ra84			
		14°			
Fixture Power	36W	1	0.24	33910	
Source Flux	4331lm	2	0.48	8478	
Fixture Flux	3683lm	3	0.72	3768	
Efficacy	103lm/W	4	0.96	2119	
TS732	I _{max} =7830cd/klm	I _{max}	33910cd	5	1.20
					1356



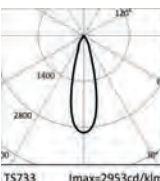

Driver	2700K	3000K	4000K
EL.	1T3572EL	1T3092EL	1T3093EL
1-10V	1T3572D	1T3092D	1T3093D
DALI	1T3572DA	1T3092DA	1T3093DA



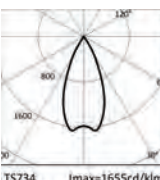

LED / 33W / REFLECTOR / SP / CRI97						    			
	3000K	H(m)	D(m)	E _{max} (lx)		Driver	2700K	3000K	4000K
	Ra97		14°			EL.		1T4272EL	
	Fixture Power	36W	1	0.24	26089	1-10V		1T4272D	
	Source Flux	3332lm	2	0.48	6522	DALI		1T4272DA	
	Fixture Flux	2834lm	3	0.72	2899				
	Efficacy	79lm/W	4	0.96	1631				
TS732	I _{max} =7830cd/klm	I _{max}	26089cd	5	1.20	1044			

LED / 33W / REFLECTOR / FL / CRI84						    			
	3000K	H(m)	D(m)	E _{max} (lx)		Driver	2700K	3000K	4000K
	Ra84		28°			EL.	1T3574EL	1T3096EL	1T3097EL
	Fixture Power	36W	1	0.50	12789	1-10V	1T3574D	1T3096D	1T3097D
	Source Flux	4331lm	2	1.00	3197	DALI	1T3574DA	1T3096DA	1T3097DA
	Fixture Flux	3666lm	3	1.50	1421				
	Efficacy	103lm/W	4	2.00	799				
TS733	I _{max} =2953cd/klm	I _{max}	12789cd	5	2.50	512			

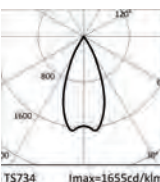
LED / 33W / REFLECTOR / FL / CRI97						    			
	3000K	H(m)	D(m)	E _{max} (lx)		Driver	2700K	3000K	4000K
	Ra97		28°			EL.		1T4274EL	
	Fixture Power	36W	1	0.50	9839	1-10V		1T4274D	
	Source Flux	3332lm	2	1.00	2460	DALI		1T4274DA	
	Fixture Flux	2820lm	3	1.50	1093				
	Efficacy	79lm/W	4	2.00	615				
TS733	I _{max} =2953cd/klm	I _{max}	9839cd	5	2.50	394			

LED / 33W / REFLECTOR / MWFL / CRI84						    			
	3000K	H(m)	D(m)	E _{max} (lx)		Driver	2700K	3000K	4000K
	Ra84		45°			EL.	1T3576EL	1T3100EL	1T3101EL
	Fixture Power	36W	1	0.82	7040	1-10V	1T3576D	1T3100D	1T3101D
	Source Flux	4331lm	2	1.64	1760	DALI	1T3576DA	1T3100DA	1T3101DA
	Fixture Flux	3764lm	3	2.46	782				
	Efficacy	105lm/W	4	3.28	440				
TS734	I _{max} =1655cd/klm	I _{max}	7166cd	5	4.10	282			

LED / 33W / REFLECTOR / MWFL / CRI97						    			
	3000K	H(m)	D(m)	E _{max} (lx)		Driver	2700K	3000K	4000K
	Ra97		45°			EL.		1T4276EL	
	Fixture Power	36W	1	0.82	5416	1-10V		1T4276D	
	Source Flux	3332lm	2	1.64	1354	DALI		1T4276DA	
	Fixture Flux	2895lm	3	2.46	602				
	Efficacy	81lm/W	4	3.28	338				
TS734	I _{max} =1655cd/klm	I _{max}	5513cd	5	4.10	217			

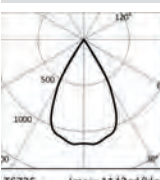
LED / 33W / REFLECTOR / WFL / CRI84						    			
	3000K	H(m)	D(m)	E _{max} (lx)		Driver	2700K	3000K	4000K
	Ra84		59°			EL.	1T3578EL	1T3104EL	1T3105EL
	Fixture Power	36W	1	1.13	4900	1-10V	1T3578D	1T3104D	1T3105D
	Source Flux	4331lm	2	2.26	1225	DALI	1T3578DA	1T3104DA	1T3105DA
	Fixture Flux	3817lm	3	3.39	544				
	Efficacy	107lm/W	4	4.51	306				
TS735	I _{max} =1142cd/klm	I _{max}	4947cd	5	5.64	196			

CCTLED ARCHITECTURAL

LED / 33W / REFLECTOR / WFL / CRI97 □ 1.6 IP20 IP23 ENEC

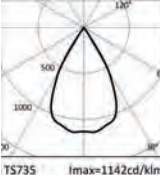

	3000K	H(m)	D(m)	E _{max} (lx)	
Ra97			59°		
Fixture Power	36W	1	1.13	3770	
Source Flux	3332lm	2	2.26	942	
Fixture Flux	2937lm	3	3.39	419	
Efficacy	82lm/W	4	4.51	236	
TS735	I _{max} =1142cd/klm	I _{max}	3806cd	5, 5.64	151

Driver	2700K	3000K	4000K
EL		1T4278EL	
1-10V		1T4278D	
DALI		1T4278DA	

LED / 26W / DBS / CRI84 □ 1.7 IP20 IP23

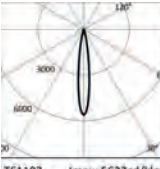

	3000K	H(m)	D(m)	E _{max} (lx)	
Ra84			14°		
Fixture Power	28W	1	0.25	19042	
Source Flux	3387lm	2	0.50	4761	
Fixture Flux	1619lm	3	0.75	2116	
Efficacy	58lm/W	4	1.00	1190	
TS1102	I _{max} =5622cd/klm	I _{max}	19042cd	5, 1.26	762

Driver	2700K	3000K	4000K
CASAMBI		1T6977CA	1T6978CA

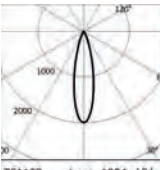

	3000K	H(m)	D(m)	E _{max} (lx)	
Ra84			24°		
Fixture Power	28W	1	0.43	6755	
Source Flux	3387lm	2	0.86	1689	
Fixture Flux	1575lm	3	1.29	751	
Efficacy	56lm/W	4	1.72	422	
TS1103	I _{max} =1994cd/klm	I _{max}	6755cd	5, 2.15	270

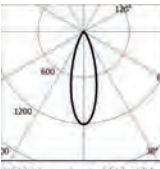

	3000K	H(m)	D(m)	E _{max} (lx)	
Ra84			31°		
Fixture Power	28W	1	0.56	4104	
Source Flux	3387lm	2	1.13	1026	
Fixture Flux	1525lm	3	1.69	456	
Efficacy	54lm/W	4	2.25	256	
TS1104	I _{max} =1212cd/klm	I _{max}	4104cd	5, 2.82	164





	3000K	H(m)	D(m)	E _{max} (lx)	
Ra84			45°		
Fixture Power	28W	1	0.83	1955	
Source Flux	3387lm	2	1.67	489	
Fixture Flux	1338lm	3	2.50	217	
Efficacy	48lm/W	4	3.34	122	
TS1105	I _{max} =577cd/klm	I _{max}	1955cd	5, 4.17	78

Accessories



Reflector



Colour	Code
	1T3138
	1T3139
	1T3422

Secondary reflector.



Grid

Ø	Code
80	1T3423



Anti-glare louver.
Black painted metal honeycomb structure.

Filter



Filter	Ø	Code
Red	80	1T3424
Green	80	1T3425
Blue	80	1T3426
Yellow	80	1T3427
Magenta	80	1T3428

Flat glass interference chromatic filter.



Ø	Code
80	1T3141

Flat glass, grooved refractive blade light filter.
This makes the beam take on an oval shape and when combined with spotlights, the light blade appears more prominent.



Ø	Code
80	1T3140

Flat glass micro prismatic refractive diffusive filter.
This softens the luminous effect.



Filter	Ø	Code
Halogen +	80	1T6382
Vivid +	80	1T6384

Art filter.
Flat glass interference filter that can vary the colour parameters of the emission of the fixtures it is applied to.
To be used only with 3000K and Ra80 fixtures.

Filter	Ø	Code
Meat	80	1T6386
Fish	80	1T6388
Bread	80	1T6390
Vegetables	80	1T6392

Food filter.
Flat glass interference filter that can vary the colour parameters of the emission of the fixtures it is applied to.
1T6386
To be used only with 3000K and Ra80 fixtures.
1T6388
To be used only with 4000K and Ra80 fixtures.
1T6390
To be used only with 3000K and Ra80 fixtures.
1T6392
To be used only with 3000K and Ra80 fixtures.





Filter	Ø	Code
Beauty	80	1T6394

Beauty filter.
Flat glass interference filter that can vary the colour parameters of the emission of the fixtures it is applied to.
To be used only with 3000K and Ra80 fixtures.

CCTLED ARCHITECTURAL

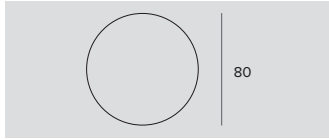
Cut-off



Ø	Code
80	1T3142

Cut-off Tube.
Allows for the beam to be focused while removing the fall-off component.
No for DBS version.

Zoom

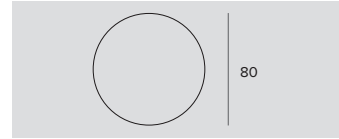

Ø	Code
80	1T3432

Zoom.
Optical system consists of an optical glass flat convex lens, an anodized aluminium specular reflector and a diffusive holographic filter.
To be used after removing the existing optic.
It makes it possible to obtain a variable beam from 15° to 60°.
It can not be used with NSP and hybrid optics; no for DBS version.

Cable

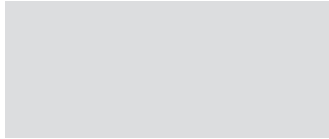

Code
1T2833

Sync cable. It synchronizes the dimming between 2 drivers.
It is possible to connect up to 10 drivers in order to maintain a uniform effect for all fixtures.

Emergency Kit

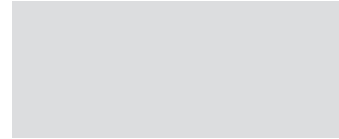
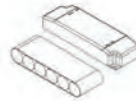

Code
1T3144

Emergency kit.
Inverter + 3h battery pack.
For CCTLED Architectural Mini: no NSP version.
IP20.

Control systems

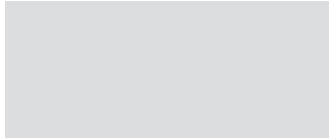

Code
1T5349

Wireless control unit for DALI fixtures.
It generates a local DALI bus that can control individual fixtures.
The module can be connected to an existing DALI network.
The module is wireless controlled using a Casambi app for smartphones and tablets using Bluetooth 4.0 technology.
The devices create a wireless mesh network that can control up to 128 fixtures.
IP20.

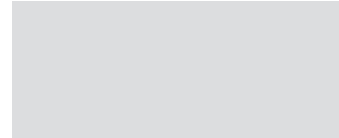

Code
1T5352

IP20 Extender for wireless control of DALI fixtures.
It generates a local DALI bus with the capacity to drive up to 64 fixtures.
Can control DALI fixtures in indoor applications.
It is also equipped with a relay that can control non-dimmable fixtures up to a maximum of 6A.



Mini Fixed Standard - Trimless

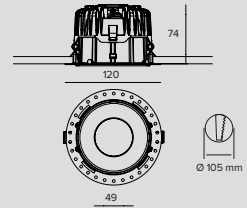

LED / 11W / LENS / SP □ 0.5 IP20 IP43

		3000K	H(m)	D(m)	E _{max} (lx)
		Ra84		15°	
Fixture Power	14W	1	0.27	16914	
Source Flux	1786lm	2	0.53	4229	
Fixture Flux	1336lm	3	0.80	1879	
Efficacy	98lm/W	4	1.07	1057	
TS874	I _{max} =9470cd/klm	I _{max}	16914cd	5	1.33
					677

Driver	Colour	3000K	4000K
EL.	○	1T4644EL	1T4645EL
DALI	○	1T4644DA	1T4645DA

LED / 18W / LENS / SP □ 0.5 IP20 IP43

		3000K	H(m)	D(m)	E _{max} (lx)
		Ra84		24°	
Fixture Power	20W	1	0.43	8803	
Source Flux	2466lm	2	0.87	2201	
Fixture Flux	1800lm	3	1.30	978	
Efficacy	89lm/W	4	1.73	550	
TS870	I _{max} =3570cd/klm	I _{max}	8803cd	5	2.17
					352

Driver	Colour	3000K	4000K
EL.	○	1T4656EL	1T4657EL
DALI	○	1T4656DA	1T4657DA

LED / 12W / LENS / FL □ 0.5 IP20 IP43

		3000K	H(m)	D(m)	E _{max} (lx)
		Ra84		30°	
Fixture Power	14W	1	0.54	4825	
Source Flux	1837lm	2	1.09	1206	
Fixture Flux	1315lm	3	1.63	536	
Efficacy	97lm/W	4	2.17	302	
TS872	I _{max} =2627cd/klm	I _{max}	4825cd	5	2.72
					193

Driver	Colour	3000K	4000K
EL.	○	1T4648EL	1T4649EL
DALI	○	1T4648DA	1T4649DA

LED / 12W / REFLECTOR / MWFL □ 0.5 IP20 IP43

		3000K	H(m)	D(m)	E _{max} (lx)
		Ra84		48°	
Fixture Power	14W	1	0.90	2476	
Source Flux	1837lm	2	1.80	619	
Fixture Flux	1520lm	3	2.69	275	
Efficacy	113lm/W	4	3.59	155	
TS873	I _{max} =1372cd/klm	I _{max}	2520cd	5	4.49
					99

Driver	Colour	3000K	4000K
EL.	○	1T4652EL	1T4653EL
DALI	○	1T4652DA	1T4653DA

LED / 18W / REFLECTOR / MWFL □ 0.5 IP20 IP43

		3000K	H(m)	D(m)	E _{max} (lx)
		Ra84		48°	
Fixture Power	20W	1	0.90	3323	
Source Flux	2466lm	2	1.80	831	
Fixture Flux	2041lm	3	2.69	369	
Efficacy	101lm/W	4	3.59	208	
TS869	I _{max} =1372cd/klm	I _{max}	3383cd	5	4.49
					133

Driver	Colour	3000K	4000K
EL.	○	1T4660EL	1T4661EL
DALI	○	1T4660DA	1T4661DA

LED / 18W / REFLECTOR / WFL □ 0.5 IP20 IP43

		3000K	H(m)	D(m)	E _{max} (lx)
		Ra84		60°	
Fixture Power	20W	1	1.16	2406	
Source Flux	2466lm	2	2.32	601	
Fixture Flux	1979lm	3	3.47	267	
Efficacy	98lm/W	4	4.63	150	
TS871	I _{max} =976cd/klm	I _{max}	2407cd	5	5.79
					96

Driver	Colour	3000K	4000K
EL.	○	1T4664EL	1T4665EL
DALI	○	1T4664DA	1T4665DA

CCTLED ARCHITECTURAL



Mini Adjustable Standard - Trimless

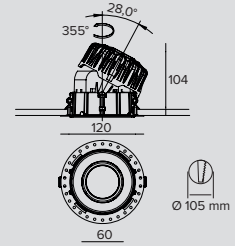

LED / 2,7W / LENS / NSP □ 0.5 IP20 IP43

		3000K	H(m)	D(m)	E _{max} (lx)	
Ra80				9°		
Fixture Power	5W	1	0.15	4436		
Source Flux	200lm	2	0.30	1109		
Fixture Flux	163lm	3	0.45	493		
Efficacy	31lm/W	4	0.60	277		
TS875	I _{max} =22178cd/klm	I _{max}	4436cd	5	0.75	177

Driver	Colour	3000K	4000K
EL.	○	1T4668EL	1T4669EL
DALI	○	1T4668DA	1T4669DA

LED / 11W / LENS / SP □ 0.5 IP20 IP43

		3000K	H(m)	D(m)	E _{max} (lx)	
Ra84				15°		
Fixture Power	14W	1	0.27	16914		
Source Flux	1786lm	2	0.53	4229		
Fixture Flux	1336lm	3	0.80	1879		
Efficacy	98lm/W	4	1.07	1057		
TS874	I _{max} =9470cd/klm	I _{max}	16914cd	5	1.33	677

Driver	Colour	3000K	4000K
EL.	○	1T4672EL	1T4673EL
DALI	○	1T4672DA	1T4673DA

LED / 18W / LENS / SP □ 0.5 IP20 IP43

		3000K	H(m)	D(m)	E _{max} (lx)	
Ra84				24°		
Fixture Power	20W	1	0.43	8803		
Source Flux	2466lm	2	0.87	2201		
Fixture Flux	1800lm	3	1.30	978		
Efficacy	89lm/W	4	1.73	550		
TS870	I _{max} =3570cd/klm	I _{max}	8803cd	5	2.17	352

Driver	Colour	3000K	4000K
EL.	○	1T4684EL	1T4685EL
DALI	○	1T4684DA	1T4685DA

LED / 12W / LENS / FL □ 0.5 IP20 IP43

		3000K	H(m)	D(m)	E _{max} (lx)	
Ra84				30°		
Fixture Power	14W	1	0.54	4825		
Source Flux	1837lm	2	1.09	1206		
Fixture Flux	1315lm	3	1.63	536		
Efficacy	97lm/W	4	2.17	302		
TS872	I _{max} =2627cd/klm	I _{max}	4825cd	5	2.72	193

Driver	Colour	3000K	4000K
EL.	○	1T4676EL	1T4677EL
DALI	○	1T4676DA	1T4677DA

LED / 12W / REFLECTOR / MWFL □ 0.5 IP20 IP43

		3000K	H(m)	D(m)	E _{max} (lx)	
Ra84				48°		
Fixture Power	14W	1	0.90	2476		
Source Flux	1837lm	2	1.80	619		
Fixture Flux	1520lm	3	2.69	275		
Efficacy	113lm/W	4	3.59	155		
TS873	I _{max} =1372cd/klm	I _{max}	2520cd	5	4.49	99

Driver	Colour	3000K	4000K
EL.	○	1T4680EL	1T4681EL
DALI	○	1T4680DA	1T4681DA

LED / 18W / REFLECTOR / MWFL □ 0.5 P20 IP43

	3000K	H(m)	D(m)	Emax(lx)		
	Ra84		48°			
	Fixture Power	20W	1	0.90	3323	
	Source Flux	2466lm	2	1.80	831	
	Fixture Flux	2041lm	3	2.69	369	
	Efficacy	101lm/W	4	3.59	208	
TS869	Imax=1372cd/klm	Imax	3383cd	5	4.49	133

Driver	Colour	3000K	4000K
EL.	○	1T4688EL	1T4689EL
DALI	○	1T4688DA	1T4689DA

LED / 18W / REFLECTOR / WFL □ 0.5 P20 IP43

	3000K	H(m)	D(m)	Emax(lx)		
	Ra84		60°			
	Fixture Power	20W	1	1.16	2406	
	Source Flux	2466lm	2	2.32	601	
	Fixture Flux	1979lm	3	3.47	267	
	Efficacy	98lm/W	4	4.63	150	
TS871	Imax=976cd/klm	Imax	2407cd	5	5.79	96

Driver	Colour	3000K	4000K
EL.	○	1T4692EL	1T4693EL
DALI	○	1T4692DA	1T4693DA

Accessories

Decorative Ring

125

Ø	Colour	Code
125	○	1T4696
125	●	1T4697

Round ring.

125

Ø	Colour	Code
125	○	1T4702
125	●	1T4703

Pinhole ring for the adjustable version.
We recommend this in combination with the black secondary reflector.

125

Ø	Colour	Code
125	○	1T4704
125	●	1T4705

Round ring (IP54).

125

L	Colour	Code
125	○	1T4698
125	●	1T4699

Square ring.

125

L	Colour	Code
125	○	1T4714
125	●	1T4715
125	○ ●	1T4716
125	○ ●	1T4717

Square ring with square hole.
For the adjustable version.

CCTLED ARCHITECTURAL

Reflector

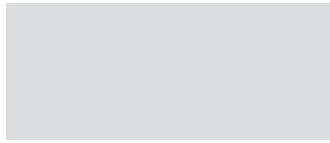

Colour	Code
○	1T4710
●	1T4711

Secondary reflector for the adjustable version.

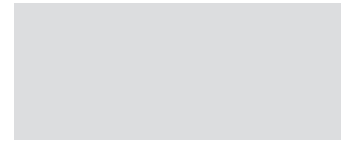

Colour	Code
○	1T4706
●	1T4707

Secondary reflector for the fixed version.

Filter

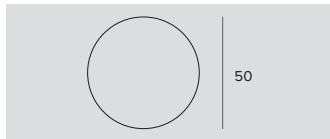

Filter	Ø	Code
Red	50	49881
Green	50	49882
Blue	50	49886
Yellow	50	49887
Magenta	50	49959

Flat glass interference chromatic filter.

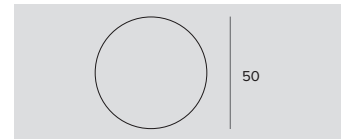

Ø	Code
50	1T4721

PMMA holographic filter with blade effect to ovalize the light beam; more evident when combined with spot and flood optics.

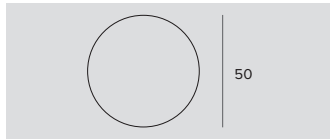

Filter	Ø	Code
Beauty	50	1T6393

Beauty filter.

Flat glass interference filter that can vary the colour parameters of the emission of the fixtures it is applied to.

To be used only with 3000K and Ra80 fixtures.

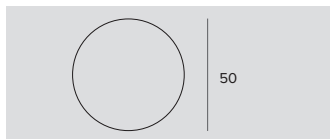

Filter	Ø	Code
Halogen +	50	1T6381
Vivid +	50	1T6383

Art filter.

Flat glass interference filter that can vary the colour parameters of the emission of the fixtures it is applied to.

To be used only with 3000K and Ra80 fixtures.

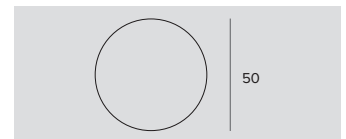

Filter	Ø	Code
Meat	50	1T6385
Fish	50	1T6387
Bread	50	1T6389
Vegetables	50	1T6391

Food filter.

Flat glass interference filter that can vary the colour parameters of the emission of the fixtures it is applied to.

1T6385

To be used only with 3000K and Ra80 fixtures.

1T6387

To be used only with 4000K and Ra80 fixtures.

1T6389



To be used only with 3000K and Ra80 fixtures.

1T6391

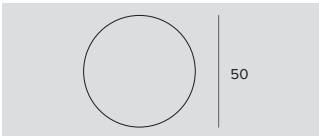
To be used only with 3000K and Ra80 fixtures.

Grid	
	
	Ø 50
	Code
	1T4322

Anti-glare louver.
Black painted metal honeycomb structure.
Complete with holographic diffusion filter.

Insertion Ring			
			
	Ø 125 mm		
	Cutout hole		
	Colour		
	Code		
	Ø125	○	1T5242
	Ø125	●	1T5243
	Ø125	●	1T5244

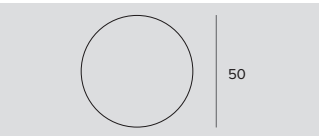

Accessory for trimless inspectable installation.
Secondary reflector.

Zoom	
	
	Ø 50
	Code
	1T4324

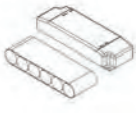
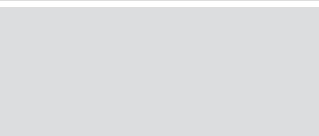
Zoom.
Optical system consists of an optical glass flat convex lens, an anodized aluminium specular reflector and a diffusive holographic filter.
To be used after removing the existing optic.
It can not be used with a narrow spot optic.
It makes it possible to obtain a variable beam from 15° to 60°.

Emergency Kit	
	
	Code
	1T3144

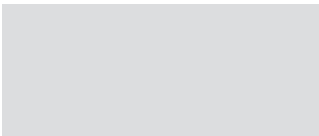
Emergency kit.
Inverter + 3h battery pack.
For CCTLED Architectural Mini: no NSP version.
IP20.

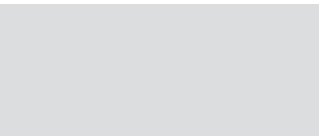
Control systems	
	
	Code
	1T5349
	
	Code
	1T5352

Wireless control unit for DALI fixtures.
It generates a local DALI bus that can control individual fixtures.
The module can be connected to an existing DALI network.
The module is wireless controlled using a Casambi app for smartphones and tablets using Bluetooth 4.0 technology.
The devices create a wireless mesh network that can control up to 128 fixtures.
IP20.

IP20 Extender for wireless control of DALI fixtures.
It generates a local DALI bus with the capacity to drive up to 64 fixtures.
Can control DALI fixtures in indoor applications.
It is also equipped with a relay that can control non-dimmable fixtures up to a maximum of 6A.

CCTLED ARCHITECTURAL



Mini GU10 Fixed Standard -Trimless

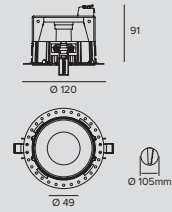

LED MR16 / 6-7-7,5W / GU10

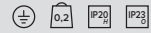

Power supply	Colour	Code
220-240Vac	○	1T5935



Mini GU10 Adjustable Standard -Trimless

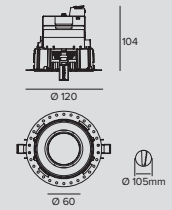

LED MR16 / 6-7-7,5W / GU10



Power supply	Colour	Code
220-240Vac	○	1T5936

Note

Lamp height max 58mm. To ensure CCTLED ARCHITECTURAL MINI GU10 functions correctly, we recommend you use the lamps indicated in this catalogue.

Accessories

Source

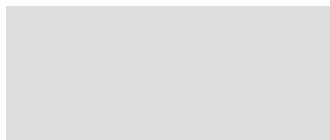

Code

38630P

PAR16 LED on/off 6W (3000K) 700cd (38°) GU10.
230V
H=57.5mm.

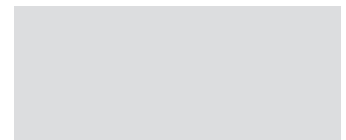

Code

38640P

PAR16 LED on/off 6W (4000K) 725cd (38°) GU10.
230V
H=57.5mm.

Reflector

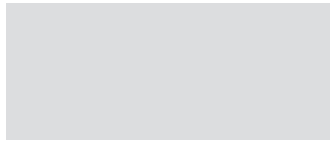

Colour	Code
○	1T4710
●	1T4711

Secondary reflector for the adjustable version.

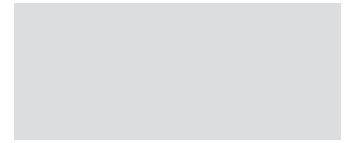

Colour	Code
○	1T4706
●	1T4707

Secondary reflector for the fixed version.

Decorative Ring



Ø	Colour	Code
125	○	1T4696
125	●	1T4697

Round ring.

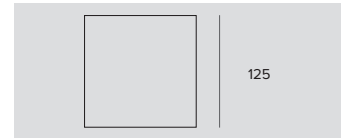

L	Colour	Code
125	○	1T4698
125	●	1T4699

Square ring.



Ø	Colour	Code
125	○	1T4700
125	●	1T4701

Pinhole ring for the fixed version.
We recommend this in combination with the black secondary reflector.

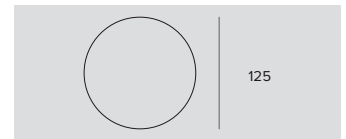

Ø	Colour	Code
125	○	1T4702
125	●	1T4703

Pinhole ring for the adjustable version.
We recommend this in combination with the black secondary reflector.

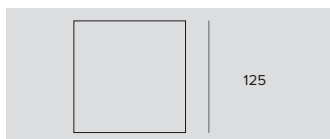

L	Colour	Code
125	○	1T4714
125	●	1T4715
125	○ ●	1T4716
125	○ ●	1T4717

Square ring with square hole.
For the adjustable version.



Ø	Colour	Code
125	○	1T4704
125	●	1T4705

Round ring (IP54).

Insertion Ring

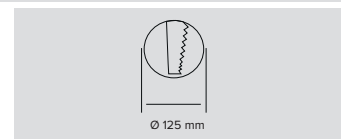

Cutout hole	Colour	Code
Ø125	○	1T5242
Ø125	●	1T5243
Ø125	○ ●	1T5244

Accessory for trimless inspectable installation.
Secondary reflector.

CCTLED ARCHITECTURAL



Micro

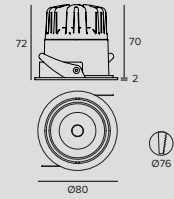

LED / 12W / SP									
	3000K	H(m)	D(m)	Emax(lx)	Power supply	Colour	3000K	4000K	
	Ra84		21°		350mA	○	1T6361	1T6362	
	Fixture Power	14W	1	0.37	7337	350mA	●	1T6367	1T6368
	Source Flux	1798lm	2	0.73	1834				
	Fixture Flux	1453lm	3	1.10	815				
	Efficacy	104lm/W	4	1.46	459				
TS1041	Imax=4080cd/klm	Imax	7337cd	5	1.83	293			

LED / 12W / FL									
	3000K	H(m)	D(m)	Emax(lx)	Power supply	Colour	3000K	4000K	
	Ra84		36°		350mA	○	1T6363	1T6364	
	Fixture Power	14W	1	0.64	3320	350mA	●	1T6369	1T6370
	Source Flux	1798lm	2	1.28	830				
	Fixture Flux	1458lm	3	1.92	369				
	Efficacy	104lm/W	4	2.56	207				
TS1042	Imax=1846cd/klm	Imax	3320cd	5	3.20	133			

LED / 12W / WFL									
	3000K	H(m)	D(m)	Emax(lx)	Power supply	Colour	3000K	4000K	
	Ra84		55°		350mA	○	1T6365	1T6366	
	Fixture Power	14W	1	1.03	1708	350mA	●	1T6371	1T6372
	Source Flux	1798lm	2	2.06	427				
	Fixture Flux	1354lm	3	3.10	190				
	Efficacy	97lm/W	4	4.13	107				
TS1043	Imax=950cd/klm	Imax	1708cd	5	5.16	68			

Related codes

Power Supply	
Code 1T6503	Code 1T6504
Electronic power supply max 15W, LxHxP=101.5x29.5x51mm, 220-240V-AC 50-60Hz, 350mA, IP20.	DALI dimmable electronic power supply max 15W, LxHxP=146.5x30x44mm, 220-240V-AC 50-60Hz, 350mA, IP20. For the Cozy product: the driver is bigger than the cutout hole needed by the luminaire.

Accessories

Reflector	
	
Colour	Code
○	1T6407
●	1T6408

Secondary reflector.

Emergency Kit	
	
	Code
	1T3144

Emergency kit.
 Inverter + 3h battery pack.
 For CCTLED Architectural Mini: no NSP version.
 IP20.

Control systems	
	
	Code
	1T5349

Wireless control unit for DALI fixtures.
 It generates a local DALI bus that can control individual fixtures.
 The module can be connected to an existing DALI network.
 The module is wireless controlled using a Casambi app for smartphones and tablets using Bluetooth 4.0 technology.
 The devices create a wireless mesh network that can control up to 128 fixtures.
 IP20.

	
	Code
	1T5352

IP20 Extender for wireless control of DALI fixtures.
 It generates a local DALI bus with the capacity to drive up to 64 fixtures.
 Can control DALI fixtures in indoor applications.
 It is also equipped with a relay that can control non-dimmable fixtures up to a maximum of 6A.

OZ

Stand alone

GENERAL INFO

Recessed fixed LED single or multi-optic projectors.

Small

	Trimless	Classic
1x	30x30mm h.50mm	35x35mm h.49mm
3x	80x35mm h.50mm	85x35mm h.49mm
5x	130x35mm h.50mm	135x35mm h.49mm

Large

	Trimless	Classic
1x	53x53mm h.61mm	60x60mm h.59mm
3x	153x53mm h.61mm	160x60mm h.59mm
5x	253x53mm h.61mm	260x60mm h.59mm

LED

LED emitter for the Small version

LED Chip on Board for the Large version

From 188lm to 3295lm

2700K – 3000K – 3500K - 4000K

Ra90

PRODUCT EFFICACY

Up to 101lm/W

OPTICS

SP – FL – MWFL

POWER SUPPLY

Electronic remote and DALI driver for the Small versions. Electronic and DALI driver integrated into the body of the fixture for the Large versions.

Casambi control system available with an accessory (only for DALI version products).

MATERIAL

White painted die-cast aluminium body and black polycarbonate frame.

New single or multi-optic downlights with a new design with miniaturised optics inspired by the OZ 48V version. Available in two different sizes, Small and Large, for ceiling or recessed installation. SP, FL and MWFL optics are suitable for installation in work environments - UGR<13 for the Small versions and UGR<17 for the Large versions (EN12464-1).

Large version available also for the ceiling installation.

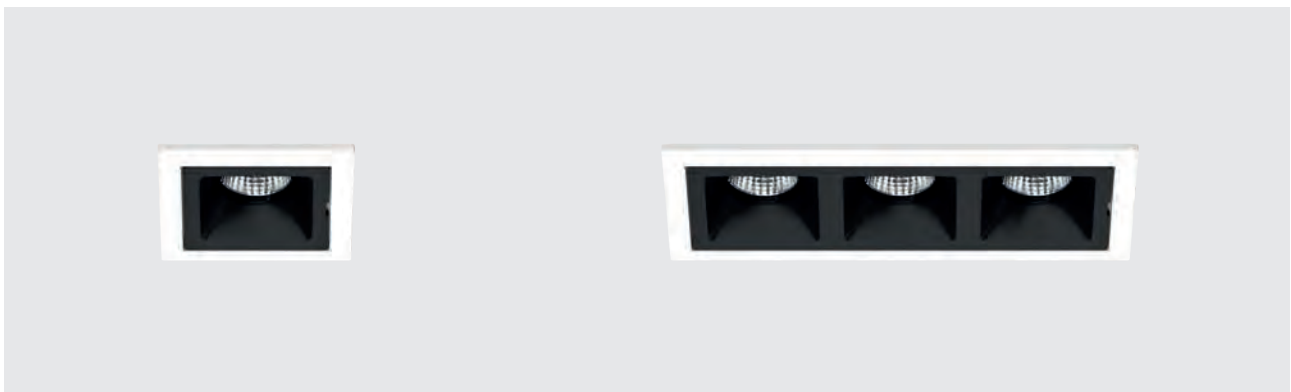



01
OZ Stand alone



SMALL
1x

SMALL
3x



SMALL
Trimless
1x

SMALL
Trimless
3x



LARGE
1x

LARGE
3x



LARGE
Trimless
1x

LARGE
Trimless
3x



Great variety of
solutions

Different solutions in terms of size, aesthetics, performance and installation to provide a valid solution for all project needs.

LARGE
Plafone
3x



SMALL
5x



SMALL
Trimless
5x

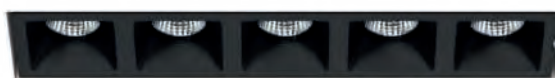

LARGE
5x



LARGE
Trimless
5x



LARGE
Plafone
5x



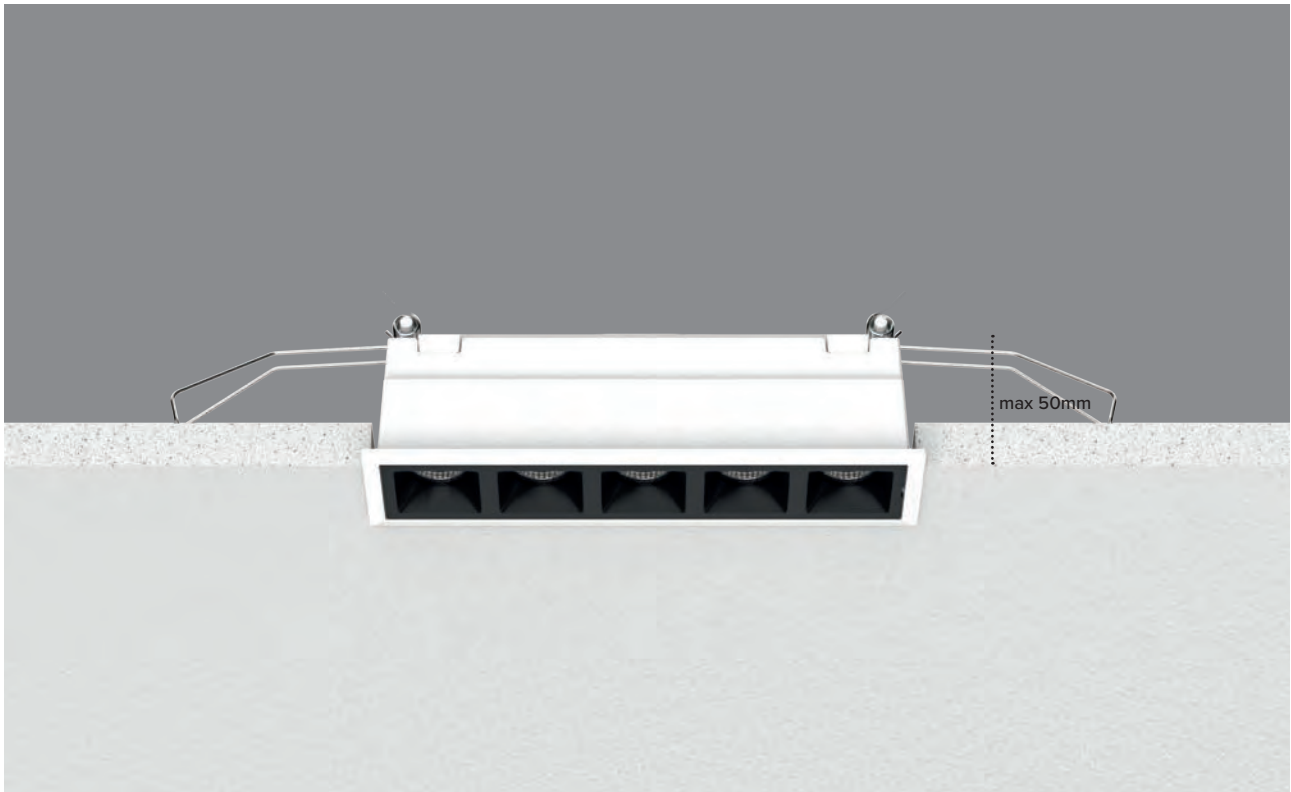

Very narrow installation dept

Both the Small and the Large versions have a very narrow installation depth. 5 cm for Small solutions and 6.1 cm for Large solutions.

Integrated or remote power supply

Electronic remote and DALI driver for the Small versions. Electronic and DALI driver integrated into the body of the fixture for the Large versions.

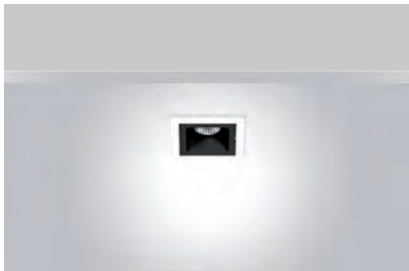

Stand Alone Recessed Small 1X (35x35mm)

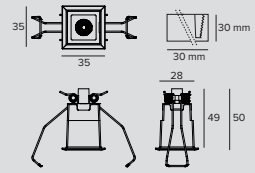

LED / 2,6W / SP											
	3000K	H(m)	D(m)	Emax(lx)		Power supply	Colour	2700K	3000K	3500K	4000K
	Ra90			12°		900mA	○	1T7602	1T7603	1T7604	1T7605
	Fixture Power	3W	1	0.20	2863	900mA	●	1T7614	1T7615	1T7616	1T7617
	Source Flux	236lm	2	0.40	716						
	Fixture Flux	202lm	3	0.61	318						
	Efficacy	77lm/W	4	0.81	179						
TS1191	Imax=12133cd/klm	Imax	2863cd	5	1.01	115					

LED / 2,6W / FL											
	3000K	H(m)	D(m)	Emax(lx)		Power supply	Colour	2700K	3000K	3500K	4000K
	Ra90			29°		900mA	○	1T7606	1T7607	1T7608	1T7609
	Fixture Power	3W	1	0.51	752	900mA	●	1T7618	1T7619	1T7620	1T7621
	Source Flux	236lm	2	1.02	188						
	Fixture Flux	197lm	3	1.53	84						
	Efficacy	76lm/W	4	2.04	47						
TS1192	Imax=3188cd/klm	Imax	752cd	5	2.55	30					

LED / 2,6W / WFL											
	3000K	H(m)	D(m)	Emax(lx)		Power supply	Colour	2700K	3000K	3500K	4000K
	Ra90			56°		900mA	○	1T7610	1T7611	1T7612	1T7613
	Fixture Power	3W	1	1.07	268	900mA	●	1T7622	1T7623	1T7624	1T7625
	Source Flux	236lm	2	2.14	67						
	Fixture Flux	198lm	3	3.21	30						
	Efficacy	76lm/W	4	4.28	17						
TS1193	Imax=1171cd/klm	Imax	276cd	5	5.35	11					



Stand Alone Recessed Small 3X (85x35mm)

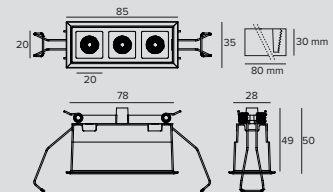

LED / 5,2W / SP											
	3000K	H(m)	D(m)	Emax(lx)		Power supply	Colour	2700K	3000K	3500K	4000K
	Ra90			12°		600mA	○	1T7626	1T7627	1T7628	1T7629
	Fixture Power	5W	1	0.20	5751	600mA	●	1T7638	1T7639	1T7640	1T7641
	Source Flux	474lm	2	0.40	1438						
	Fixture Flux	406lm	3	0.61	639						
	Efficacy	78lm/W	4	0.81	359						
TS1191	Imax=12133cd/klm	Imax	5751cd	5	1.01	230					

LED / 5,2W / FL



	3000K	H(m)	D(m)	E _{max} (lx)		
	Ra90		29°			
	Fixture Power	5W	1	0.51	1511	
	Source Flux	474lm	2	1.02	378	
	Fixture Flux	397lm	3	1.53	168	
	Efficacy	76lm/W	4	2.04	94	
TS1192	I _{max} =3188cd/klm	I _{max}	1511cd	5	2.55	60

Power supply	Colour	2700K	3000K	3500K	4000K
600mA	○	1T7630	1T7631	1T7632	1T7633
600mA	●	1T7642	1T7643	1T7644	1T7645

LED / 5,2W / WFL



	3000K	H(m)	D(m)	E _{max} (lx)		
	Ra90		56°			
	Fixture Power	5W	1	1.07	538	
	Source Flux	474lm	2	2.14	134	
	Fixture Flux	397lm	3	3.21	60	
	Efficacy	76lm/W	4	4.28	34	
TS1193	I _{max} =1171cd/klm	I _{max}	555cd	5	5.35	22

Power supply	Colour	2700K	3000K	3500K	4000K
600mA	○	1T7634	1T7635	1T7636	1T7637
600mA	●	1T7646	1T7647	1T7648	1T7649



Stand Alone Recessed Small 5X (135x35mm)

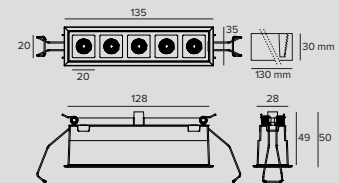

LED / 8,7W / SP



	3000K	H(m)	D(m)	E _{max} (lx)		
	Ra90		12°			
	Fixture Power	9W	1	0.20	9598	
	Source Flux	791lm	2	0.40	2399	
	Fixture Flux	678lm	3	0.61	1066	
	Efficacy	78lm/W	4	0.81	600	
TS1191	I _{max} =12133cd/klm	I _{max}	9598cd	5	1.01	384

Power supply	Colour	2700K	3000K	3500K	4000K
600mA	○	1T7650	1T7651	1T7652	1T7653
600mA	●	1T7662	1T7663	1T7664	1T7665

LED / 8,7W / FL



	3000K	H(m)	D(m)	E _{max} (lx)		
	Ra90		29°			
	Fixture Power	9W	1	0.51	2522	
	Source Flux	791lm	2	1.02	630	
	Fixture Flux	662lm	3	1.53	280	
	Efficacy	76lm/W	4	2.04	158	
TS1192	I _{max} =3188cd/klm	I _{max}	2522cd	5	2.55	101

Power supply	Colour	2700K	3000K	3500K	4000K
600mA	○	1T7654	1T7655	1T7656	1T7657
600mA	●	1T7666	1T7667	1T7668	1T7669

LED / 8,7W / WFL



	3000K	H(m)	D(m)	E _{max} (lx)		
	Ra90		56°			
	Fixture Power	9W	1	1.07	898	
	Source Flux	791lm	2	2.14	224	
	Fixture Flux	663lm	3	3.21	100	
	Efficacy	76lm/W	4	4.28	56	
TS1193	I _{max} =1171cd/klm	I _{max}	926cd	5	5.35	36

Power supply	Colour	2700K	3000K	3500K	4000K
600mA	○	1T7658	1T7659	1T7660	1T7661
600mA	●	1T7670	1T7671	1T7672	1T7673

Note

Small version: to be completed with an electronic or DALI driver.

Related codes

Power Supply

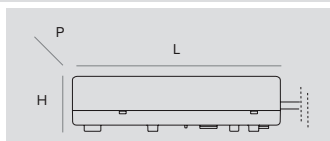

Code

900mA - for 1x version. Can power series of up to 5 OZ

1T5295EL

600mA - for 3x - 5x versions. Can power series of up to 3 OZ of 3x and 2 OZ of 5x

1T8172EL

Electronic power supply 20W, LxHxP=110x22x52mm, 110-240V, 900mA, IP20.
Note: the driver is larger than the recessed hole.

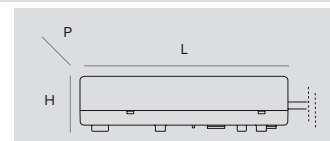

Code

900mA - for 1x version. Can power series of up to 5 OZ

1T7686DA

600mA - for 3x - 5x versions. Can power series of up to 3 OZ of 3x and 2 OZ of 5x

1T8172DA

DALI power supply 20W, LxHxW=156x25,5x51,5mm, 230V, IP20.
Note: the driver is larger than the recessed hole.

Accessories

Control systems



Code

1T5349

Wireless control unit for DALI fixtures.
It generates a local DALI bus that can control individual fixtures.
The module can be connected to an existing DALI network.
The module is wireless controlled using a Casambi app for smartphones and tablets using Bluetooth 4.0 technology.
The devices create a wireless mesh network that can control up to 128 fixtures.
IP20.



Code

1T5352

IP20 Extender for wireless control of DALI fixtures.
It generates a local DALI bus with the capacity to drive up to 64 fixtures.
Can control DALI fixtures in indoor applications.
It is also equipped with a relay that can control non-dimmable fixtures up to a maximum of 6A.



Stand Alone Recessed Small 1X (60x60mm)

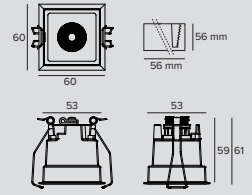

LED / 6W / SP											
	3000K	H(m)	D(m)	Emax(lx)	Driver	Colour	2700K	3000K	3500K	4000K	
	Ra90			19°	EL.	○	1T7746EL	1T7747EL	1T7748EL	1T7749EL	
	Fixture Power	7W	1	0.33	3138	EL.	●	1T7758EL	1T7759EL	1T7760EL	1T7761EL
	Source Flux	656lm	2	0.66	785	DALI	○	1T7746DA	1T7747DA	1T7748DA	1T7749DA
	Fixture Flux	513lm	3	0.99	349	DALI	●	1T7758DA	1T7759DA	1T7760DA	1T7761DA
	Efficacy	74lm/W	4	1.32	196						
TS1194	Imax=4784cd/klm	Imax	3138cd	5	1.65	126					

LED / 6W / FL											
	3000K	H(m)	D(m)	Emax(lx)	Driver	Colour	2700K	3000K	3500K	4000K	
	Ra90			34°	EL.	○	1T7750EL	1T7751EL	1T7752EL	1T7753EL	
	Fixture Power	7W	1	0.61	1748	EL.	●	1T7762EL	1T7763EL	1T7764EL	1T7765EL
	Source Flux	839lm	2	1.22	437	DALI	○	1T7750DA	1T7751DA	1T7752DA	1T7753DA
	Fixture Flux	599lm	3	1.83	194	DALI	●	1T7762DA	1T7763DA	1T7764DA	1T7765DA
	Efficacy	87lm/W	4	2.43	109						
TS1195	Imax=2083cd/klm	Imax	1748cd	5	3.04	70					

LED / 6W / WFL											
	3000K	H(m)	D(m)	Emax(lx)	Driver	Colour	2700K	3000K	3500K	4000K	
	Ra90			50°	EL.	○	1T7754EL	1T7755EL	1T7756EL	1T7757EL	
	Fixture Power	7W	1	0.93	1052	EL.	●	1T7766EL	1T7767EL	1T7768EL	1T7769EL
	Source Flux	839lm	2	1.85	263	DALI	○	1T7754DA	1T7755DA	1T7756DA	1T7757DA
	Fixture Flux	649lm	3	2.78	117	DALI	●	1T7766DA	1T7767DA	1T7768DA	1T7769DA
	Efficacy	94lm/W	4	3.71	66						
TS1196	Imax=1254cd/klm	Imax	1052cd	5	4.64	42					



Stand Alone Recessed Small 3X (160x60mm)

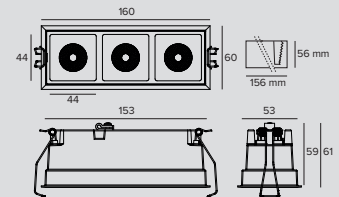

LED / 18W / SP											
	3000K	H(m)	D(m)	Emax(lx)	Driver	Colour	2700K	3000K	3500K	4000K	
	Ra90			19°	EL.	○	1T7770EL	1T7771EL	1T7772EL	1T7773EL	
	Fixture Power	20W	1	0.33	9415	EL.	●	1T7782EL	1T7783EL	1T7784EL	1T7785EL
	Source Flux	1968lm	2	0.66	2354	DALI	○	1T7770DA	1T7771DA	1T7772DA	1T7773DA
	Fixture Flux	1538lm	3	0.99	1046	DALI	●	1T7782DA	1T7783DA	1T7784DA	1T7785DA
	Efficacy	77lm/W	4	1.32	588						
TS1194	Imax=4784cd/klm	Imax	9415cd	5	1.65	377					

LED / 18W / FL



	3000K	H(m)	D(m)	E _{max} (lx)		
	Ra90		34°			
	Fixture Power	20W	1	0.61	5243	
	Source Flux	2517lm	2	1.22	1311	
	Fixture Flux	1797lm	3	1.83	583	
	Efficacy	90lm/W	4	2.43	328	
TS1195	I _{max} =2083cd/klm	I _{max}	5243cd	5	3.04	210

Driver	Colour	2700K	3000K	3500K	4000K
EL.	○	1T7774EL	1T7775EL	1T7776EL	1T7777EL
EL.	●	1T7786EL	1T7787EL	1T7788EL	1T7789EL
DALI	○	1T7774DA	1T7775DA	1T7776DA	1T7777DA
DALI	●	1T7786DA	1T7787DA	1T7788DA	1T7789DA

LED / 18W / WFL



	3000K	H(m)	D(m)	E _{max} (lx)		
	Ra90		50°			
	Fixture Power	20W	1	0.93	3157	
	Source Flux	2517lm	2	1.85	789	
	Fixture Flux	1947lm	3	2.78	351	
	Efficacy	97lm/W	4	3.71	197	
TS1196	I _{max} =1254cd/klm	I _{max}	3157cd	5	4.64	126

Driver	Colour	2700K	3000K	3500K	4000K
EL.	○	1T7778EL	1T7779EL	1T7780EL	1T7781EL
EL.	●	1T7790EL	1T7791EL	1T7792EL	1T7793EL
DALI	○	1T7778DA	1T7779DA	1T7780DA	1T7781DA
DALI	●	1T7790DA	1T7791DA	1T7792DA	1T7793DA



Stand Alone Recessed Large 5X (260x60mm)

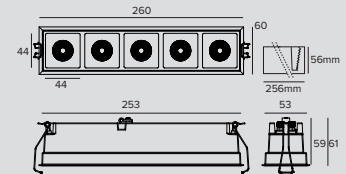

LED / 30W / SP



	3000K	H(m)	D(m)	E _{max} (lx)		
	Ra90		19°			
	Fixture Power	34W	1	0.33	15692	
	Source Flux	3280lm	2	0.66	3923	
	Fixture Flux	2563lm	3	0.99	1744	
	Efficacy	75lm/W	4	1.32	981	
TS1194	I _{max} =4784cd/klm	I _{max}	15692cd	5	1.65	628

Driver	Colour	2700K	3000K	3500K	4000K
EL.	○	1T7794EL	1T7795EL	1T7796EL	1T7797EL
EL.	●	1T7806EL	1T7807EL	1T7808EL	1T7809EL
DALI	○	1T7794DA	1T7795DA	1T7796DA	1T7797DA
DALI	●	1T7806DA	1T7807DA	1T7808DA	1T7809DA

LED / 30W / FL



	3000K	H(m)	D(m)	E _{max} (lx)		
	Ra90		34°			
	Fixture Power	34W	1	0.61	8739	
	Source Flux	4195lm	2	1.22	2185	
	Fixture Flux	2996lm	3	1.83	971	
	Efficacy	88lm/W	4	2.43	546	
TS1195	I _{max} =2083cd/klm	I _{max}	8739cd	5	3.04	350

Driver	Colour	2700K	3000K	3500K	4000K
EL.	○	1T7798EL	1T7799EL	1T7800EL	1T7801EL
EL.	●	1T7810EL	1T7811EL	1T7812EL	1T7813EL
DALI	○	1T7798DA	1T7799DA	1T7800DA	1T7801DA
DALI	●	1T7810DA	1T7811DA	1T7812DA	1T7813DA

LED / 30W / WFL



	3000K	H(m)	D(m)	E _{max} (lx)		
	Ra90		50°			
	Fixture Power	34W	1	0.93	5262	
	Source Flux	4195lm	2	1.85	1315	
	Fixture Flux	3246lm	3	2.78	585	
	Efficacy	95lm/W	4	3.71	329	
TS1196	I _{max} =1254cd/klm	I _{max}	5262cd	5	4.64	210

Driver	Colour	2700K	3000K	3500K	4000K
EL.	○	1T7802EL	1T7803EL	1T7804EL	1T7805EL
EL.	●	1T7814EL	1T7815EL	1T7816EL	1T7817EL
DALI	○	1T7802DA	1T7803DA	1T7804DA	1T7805DA
DALI	●	1T7814DA	1T7815DA	1T7816DA	1T7817DA



Stand Alone Trimless Small 1X (30x30mm)

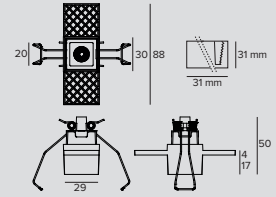

LED / 2,6W / SP



	3000K	H(m)	D(m)	E _{max} (lx)		
	Ra90		12°			
	Fixture Power	3W	1	0.20	2863	
	Source Flux	236lm	2	0.40	716	
	Fixture Flux	202lm	3	0.61	318	
	Efficacy	77lm/W	4	0.81	179	
TS1191	I _{max} =12133cd/klm	I _{max}	2863cd	5	1.01	115

Power supply	2700K	3000K	3500K	4000K
900mA	1T7674	1T7675	1T7676	1T7677

LED / 2,6W / FL



	3000K	H(m)	D(m)	E _{max} (lx)		
	Ra90		29°			
	Fixture Power	3W	1	0.51	752	
	Source Flux	236lm	2	1.02	188	
	Fixture Flux	197lm	3	1.53	84	
	Efficacy	76lm/W	4	2.04	47	
TS1192	I _{max} =3188cd/klm	I _{max}	752cd	5	2.55	30

Power supply	2700K	3000K	3500K	4000K
900mA	1T7678	1T7679	1T7680	1T7681

LED / 2,6W / WFL



	3000K	H(m)	D(m)	E _{max} (lx)		
	Ra90		56°			
	Fixture Power	3W	1	1.07	268	
	Source Flux	236lm	2	2.14	67	
	Fixture Flux	198lm	3	3.21	30	
	Efficacy	76lm/W	4	4.28	17	
TS1193	I _{max} =1171cd/klm	I _{max}	276cd	5	5.35	11

Power supply	2700K	3000K	3500K	4000K
900mA	1T7682	1T7683	1T7684	1T7685



Stand Alone Trimless Small 3X (80x30mm)

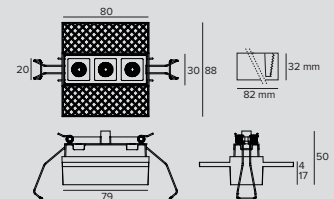

LED / 5,2W / SP



	3000K	H(m)	D(m)	E _{max} (lx)		
	Ra90		12°			
	Fixture Power	5W	1	0.20	5751	
	Source Flux	474lm	2	0.40	1438	
	Fixture Flux	406lm	3	0.61	639	
	Efficacy	78lm/W	4	0.81	359	
TS1191	I _{max} =12133cd/klm	I _{max}	5751cd	5	1.01	230

Power supply	2700K	3000K	3500K	4000K
600mA	1T7698	1T7699	1T7700	1T7701

LED / 5,2W / FL



	3000K	H(m)	D(m)	E _{max} (lx)		
	Ra90		29°			
	Fixture Power	5W	1	0.51	1511	
	Source Flux	474lm	2	1.02	378	
	Fixture Flux	397lm	3	1.53	168	
	Efficacy	76lm/W	4	2.04	94	
TS1192	I _{max} =3188cd/klm	I _{max}	1511cd	5	2.55	60

Power supply	Driver	2700K	3000K	3500K	4000K
600mA		1T7702	1T7703	1T7704	1T7705

LED / 5,2W / WFL

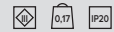

	3000K	H(m)	D(m)	E _{max} (lx)		
	Ra90		56°			
	Fixture Power	5W	1	1.07	538	
	Source Flux	474lm	2	2.14	134	
	Fixture Flux	397lm	3	3.21	60	
	Efficacy	76lm/W	4	4.28	34	
TS1193	I _{max} =1171cd/klm	I _{max}	555cd	5	5.35	22

Power supply	Driver	2700K	3000K	3500K	4000K
600mA		1T7706	1T7707	1T7708	1T7709



Stand Alone Trimless Small 5X (130x30mm)

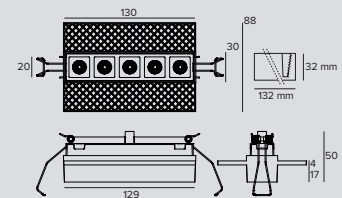

LED / 13W / SP

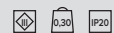

	3000K	H(m)	D(m)	E _{max} (lx)		
	Ra90		12°			
	Fixture Power	9W	1	0.20	9598	
	Source Flux	791lm	2	0.40	2399	
	Fixture Flux	678lm	3	0.61	1066	
	Efficacy	78lm/W	4	0.81	600	
TS1191	I _{max} =12133cd/klm	I _{max}	9598cd	5	1.01	384

Power supply	2700K	3000K	3500K	4000K
600mA	1T7722	1T7723	1T7724	1T7725

LED / 13W / FL



	3000K	H(m)	D(m)	E _{max} (lx)		
	Ra90		29°			
	Fixture Power	9W	1	0.51	2522	
	Source Flux	791lm	2	1.02	630	
	Fixture Flux	662lm	3	1.53	280	
	Efficacy	76lm/W	4	2.04	158	
TS1192	I _{max} =3188cd/klm	I _{max}	2522cd	5	2.55	101

Power supply	2700K	3000K	3500K	4000K
600mA	1T7726	1T7727	1T7728	1T7729

LED / 13W / WFL



	3000K	H(m)	D(m)	E _{max} (lx)		
	Ra90		56°			
	Fixture Power	9W	1	1.07	898	
	Source Flux	791lm	2	2.14	224	
	Fixture Flux	663lm	3	3.21	100	
	Efficacy	76lm/W	4	4.28	56	
TS1193	I _{max} =1171cd/klm	I _{max}	926cd	5	5.35	36

Power supply	2700K	3000K	3500K	4000K
600mA	1T7730	1T7731	1T7732	1T7733

Note

Small version: to be completed with an electronic or DALI driver.

OZ

Related codes

Power Supply

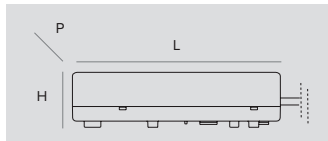

Code

900mA - for 1x version. Can power series of up to 5 OZ

1T5295EL

600mA - for 3x - 5x versions. Can power series of up to 3 OZ of 3x and 2 OZ of 5x

1T8172EL

Electronic power supply 20W, LxHxP=110x22x52mm, 110-240V, 900mA, IP20.
Note: the driver is larger than the recessed hole.

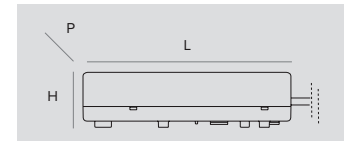

Code

900mA - for 1x version. Can power series of up to 5 OZ

1T7686DA

600mA - for 3x - 5x versions. Can power series of up to 3 OZ of 3x and 2 OZ of 5x

1T8172DA

DALI power supply 20W, LxHxW=156x25,5x51,5mm, 230V, IP20.
Note: the driver is larger than the recessed hole.

Accessories

Control systems



Code

1T5349

Wireless control unit for DALI fixtures.
It generates a local DALI bus that can control individual fixtures.
The module can be connected to an existing DALI network.
The module is wireless controlled using a Casambi app for smartphones and tablets using Bluetooth 4.0 technology.
The devices create a wireless mesh network that can control up to 128 fixtures.
IP20.



Code

1T5352

IP20 Extender for wireless control of DALI fixtures.
It generates a local DALI bus with the capacity to drive up to 64 fixtures.
Can control DALI fixtures in indoor applications.
It is also equipped with a relay that can control non-dimmable fixtures up to a maximum of 6A.



Stand Alone Trimless Large 1X (53x53mm)

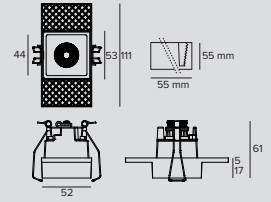

LED / 6W / SP



	3000K	H(m)	D(m)	Emax(lx)		
	Ra90		19°			
	Fixture Power	7W	1	0.33	3138	
	Source Flux	656lm	2	0.66	785	
	Fixture Flux	513lm	3	0.99	349	
	Efficacy	74lm/W	4	1.32	196	
TS1194	Imax=4784cd/klm	Imax	3138cd	5	1.65	126

Driver	2700K	3000K	3500K	4000K
EL.	1T7818EL	1T7819EL	1T7820EL	1T7821EL
DALI	1T7818DA	1T7819DA	1T7820DA	1T7821DA

LED / 6W / FL



	3000K	H(m)	D(m)	Emax(lx)		
	Ra90		34°			
	Fixture Power	7W	1	0.61	1748	
	Source Flux	839lm	2	1.22	437	
	Fixture Flux	599lm	3	1.83	194	
	Efficacy	87lm/W	4	2.43	109	
TS1195	Imax=2083cd/klm	Imax	1748cd	5	3.04	70

Driver	2700K	3000K	3500K	4000K
EL.	1T7822EL	1T7823EL	1T7824EL	1T7825EL
DALI	1T7822DA	1T7823DA	1T7824DA	1T7825DA

LED / 6W / WFL



	3000K	H(m)	D(m)	Emax(lx)		
	Ra90		50°			
	Fixture Power	7W	1	0.93	1052	
	Source Flux	839lm	2	1.85	263	
	Fixture Flux	649lm	3	2.78	117	
	Efficacy	94lm/W	4	3.71	66	
TS1196	Imax=1254cd/klm	Imax	1052cd	5	4.64	42

Driver	2700K	3000K	3500K	4000K
EL.	1T7826EL	1T7827EL	1T7828EL	1T7829EL
DALI	1T7826DA	1T7827DA	1T7828DA	1T7829DA



Stand Alone Trimless Large 3X (153x53mm)

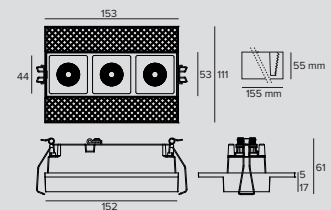

LED / 18W / SP



	3000K	H(m)	D(m)	Emax(lx)		
	Ra90		19°			
	Fixture Power	20W	1	0.33	9415	
	Source Flux	1968lm	2	0.66	2354	
	Fixture Flux	1538lm	3	0.99	1046	
	Efficacy	77lm/W	4	1.32	588	
TS1194	Imax=4784cd/klm	Imax	9415cd	5	1.65	377

Driver	2700K	3000K	3500K	4000K
EL.	1T7842EL	1T7843EL	1T7844EL	1T7845EL
DALI	1T7842DA	1T7843DA	1T7844DA	1T7845DA

LED / 18W / FL



	3000K	H(m)	D(m)	Emax(lx)		
	Ra90		34°			
	Fixture Power	20W	1	0.61	5243	
	Source Flux	2517lm	2	1.22	1311	
	Fixture Flux	1797lm	3	1.83	583	
	Efficacy	90lm/W	4	2.43	328	
TS1195	Imax=2083cd/klm	Imax	5243cd	5	3.04	210

Driver	2700K	3000K	3500K	4000K
EL.	1T7846EL	1T7847EL	1T7848EL	1T7849EL
DALI	1T7846DA	1T7847DA	1T7848DA	1T7849DA

LED / 18W / WFL



	3000K	H(m)	D(m)	Emax(lx)		
	Ra90		50°			
	Fixture Power	20W	1	0.93	3157	
	Source Flux	2517lm	2	1.85	789	
	Fixture Flux	1947lm	3	2.78	351	
	Efficacy	97lm/W	4	3.71	197	
TS1196	Imax=1254cd/klm	Imax	3157cd	5	4.64	126

Driver	2700K	3000K	3500K	4000K
EL.	1T7850EL	1T7851EL	1T7852EL	1T7853EL
DALI	1T7850DA	1T7851DA	1T7852DA	1T7853DA



Stand Alone Trimless Large 5X (253x53mm)

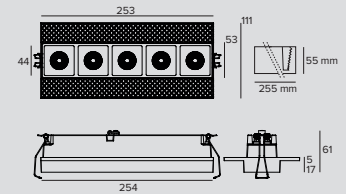

LED / 30W / SP



	3000K	H(m)	D(m)	Emax(lx)		
	Ra90		19°			
	Fixture Power	34W	1	0.33	15692	
	Source Flux	3280lm	2	0.66	3923	
	Fixture Flux	2563lm	3	0.99	1744	
	Efficacy	75lm/W	4	1.32	981	
TS1194	Imax=4784cd/klm	Imax	15692cd	5	1.65	628

Driver	2700K	3000K	3500K	4000K
EL.	1T7866EL	1T7867EL	1T7868EL	1T7869EL
DALI	1T7866DA	1T7867DA	1T7868DA	1T7869DA

LED / 30W / FL



	3000K	H(m)	D(m)	Emax(lx)		
	Ra90		34°			
	Fixture Power	34W	1	0.61	8739	
	Source Flux	4195lm	2	1.22	2185	
	Fixture Flux	2996lm	3	1.83	971	
	Efficacy	88lm/W	4	2.43	546	
TS1195	Imax=2083cd/klm	Imax	8739cd	5	3.04	350

Driver	2700K	3000K	3500K	4000K
EL.	1T7870EL	1T7871EL	1T7872EL	1T7873EL
DALI	1T7870DA	1T7871DA	1T7872DA	1T7873DA

LED / 30W / WFL



	3000K	H(m)	D(m)	Emax(lx)		
	Ra90		50°			
	Fixture Power	34W	1	0.93	5262	
	Source Flux	4195lm	2	1.85	1315	
	Fixture Flux	3246lm	3	2.78	585	
	Efficacy	95lm/W	4	3.71	329	
TS1196	Imax=1254cd/klm	Imax	5262cd	5	4.64	210

Driver	2700K	3000K	3500K	4000K
EL.	1T7874EL	1T7875EL	1T7876EL	1T7877EL
DALI	1T7874DA	1T7875DA	1T7876DA	1T7877DA



STORE

Gimbal

GENERAL INFO

Recessed adjustable projector.
Gimbal System to adjust the optical unit 30° vertically and 355° horizontally.

LED

Chip on board
From 2257lm to 4385lm
3000K – 4000K
Ra84 - Ra97

PRODUCT EFFICACY

Up to 119lm/W

OPTICS

NSP – SP – FL – MWFL – WFL

OPTICS

Electronic - DALI
Casambi control: the DALI version is fitted with special accessories.

MATERIAL

Painted die-cast aluminium projector body and external ring. Polycarbonate internal ring.

Range of recessed fixtures available in two different sizes, designed to meet the particular needs of the retail market where excellent performance, minimal design and controlled light are required.

The light units can be single, and multi-optic 1x, 2x and 3x. Mini versions available with a frame with a Trimless finish.

Also available in a projector version.

	STORE with springs	STORE with magnets	STORE MINI with springs	STORE MINI with magnets
	160x160mm	160x160mm	145x145mm	145x145mm
1x	without a frame	only with a frame accessory	with or without a trimless frame accessory	only with a frame accessory
2x	no	only with a frame accessory	with or without a trimless frame accessory	only with a frame accessory
3x	no	only with a frame accessory	with or without a trimless frame accessory	only with a frame accessory





Bruyninx DS Store

Photographer
Eddy Vanoppen

Country
Hasselt - Belgium



Gimbal modules with springs

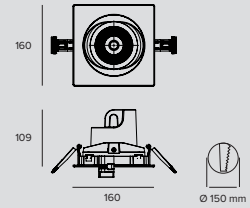

LED / 19W / REFLECTOR / SP / CR184

		3000K	H(m)	D(m)	E _{max} (lx)
		Ra84			
		14°			
Fixture Power	22W	1	0.24	23022	
Source Flux	2935lm	2	0.48	5755	
Fixture Flux	2494lm	3	0.72	2558	
Efficacy	112lm/W	4	0.96	1439	
TS947	I _{max} =7844cd/klm	I _{max}	23022cd	5	1.20
				921	

Driver	Colour	3000K	4000K
EL.	○	1T5114EL	1T5116EL
EL.	●	1T5098EL	1T5100EL
DALI	○	1T5114DA	1T5116DA
DALI	●	1T5098DA	1T5100DA

LED / 19W / REFLECTOR / SP / CR197

		3000K	H(m)	D(m)	E _{max} (lx)
		Ra97			
		14°			
Fixture Power	22W	1	0.24	17704	
Source Flux	2257lm	2	0.48	4426	
Fixture Flux	1918lm	3	0.72	1967	
Efficacy	86lm/W	4	0.96	1106	
TS947	I _{max} =7844cd/klm	I _{max}	17704cd	5	1.20
				708	

Driver	Colour	3000K	4000K
EL.	○	1T5115EL	1T5117EL
EL.	●	1T5099EL	1T5101EL
DALI	○	1T5115DA	1T5117DA
DALI	●	1T5099DA	1T5101DA

LED / 19W / REFLECTOR / FL / CR184

		3000K	H(m)	D(m)	E _{max} (lx)
		Ra84			
		27°			
Fixture Power	22W	1	0.49	9061	
Source Flux	2935lm	2	0.97	2265	
Fixture Flux	2486lm	3	1.46	1007	
Efficacy	112lm/W	4	1.95	566	
TS948	I _{max} =3087cd/klm	I _{max}	9061cd	5	2.43
				362	

Driver	Colour	3000K	4000K
EL.	○	1T5118EL	1T5120EL
EL.	●	1T5102EL	1T5104EL
DALI	○	1T5118DA	1T5120DA
DALI	●	1T5102DA	1T5104DA

LED / 19W / REFLECTOR / FL / CR197

		3000K	H(m)	D(m)	E _{max} (lx)
		Ra97			
		27°			
Fixture Power	22W	1	0.49	6968	
Source Flux	2257lm	2	0.97	1742	
Fixture Flux	1912lm	3	1.46	774	
Efficacy	86lm/W	4	1.95	435	
TS948	I _{max} =3087cd/klm	I _{max}	6968cd	5	2.43
				279	

Driver	Colour	3000K	4000K
EL.	○	1T5119EL	1T5121EL
EL.	●	1T5103EL	1T5105EL
DALI	○	1T5119DA	1T5121DA
DALI	●	1T5103DA	1T5105DA

LED / 19W / REFLECTOR / MWFL / CR184

		3000K	H(m)	D(m)	E _{max} (lx)
		Ra84			
		45°			
Fixture Power	22W	1	0.82	4770	
Source Flux	2935lm	2	1.64	1193	
Fixture Flux	2550lm	3	2.46	530	
Efficacy	115lm/W	4	3.28	298	
TS949	I _{max} =1655cd/klm	I _{max}	4856cd	5	4.10
				191	

Driver	Colour	3000K	4000K
EL.	○	1T5122EL	1T5124EL
EL.	●	1T5106EL	1T5108EL
DALI	○	1T5122DA	1T5124DA
DALI	●	1T5106DA	1T5108DA

LED / 19W / REFLECTOR / MWFL / CRI97



		3000K	H(m)	D(m)	E _{max} (lx)
		Ra97		45°	
Fixture Power	22W	1	0.82	3668	
Source Flux	2257lm	2	1.64	917	
Fixture Flux	1961lm	3	2.46	408	
Efficacy	88lm/W	4	3.28	229	
TS949	I _{max} =1655cd/klm	I _{max}	3734cd	5	4.10
				147	

Driver	Colour	3000K	4000K
EL.	○	1T5123EL	1T5125EL
EL.	●	1T5107EL	1T5109EL
DALI	○	1T5123DA	1T5125DA
DALI	●	1T5107DA	1T5109DA

LED / 19W / REFLECTOR / WFL / CRI84



		3000K	H(m)	D(m)	E _{max} (lx)
		Ra84		59°	
Fixture Power	22W	1	1.13	3318	
Source Flux	2935lm	2	2.26	830	
Fixture Flux	2585lm	3	3.39	369	
Efficacy	116lm/W	4	4.51	207	
TS950	I _{max} =1141cd/klm	I _{max}	3350cd	5	5.64
				133	

Driver	Colour	3000K	4000K
EL.	○	1T5126EL	1T5128EL
EL.	●	1T5110EL	1T5112EL
DALI	○	1T5126DA	1T5128DA
DALI	●	1T5110DA	1T5112DA

LED / 19W / REFLECTOR / WFL / CRI97

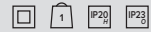

		3000K	H(m)	D(m)	E _{max} (lx)
		Ra97		59°	
Fixture Power	22W	1	1.13	2552	
Source Flux	2257lm	2	2.26	638	
Fixture Flux	1988lm	3	3.39	284	
Efficacy	90lm/W	4	4.51	159	
TS950	I _{max} =1141cd/klm	I _{max}	2576cd	5	5.64
				102	

Driver	Colour	3000K	4000K
EL.	○	1T5127EL	1T5129EL
EL.	●	1T5111EL	1T5113EL
DALI	○	1T5127DA	1T5129DA
DALI	●	1T5111DA	1T5113DA

LED / 33W / REFLECTOR / SP / CRI84

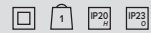

		3000K	H(m)	D(m)	E _{max} (lx)
		Ra84		14°	
Fixture Power	36W	1	0.24	33552	
Source Flux	4277lm	2	0.48	8388	
Fixture Flux	3635lm	3	0.72	3728	
Efficacy	102lm/W	4	0.96	2097	
TS951	I _{max} =7845cd/klm	I _{max}	33552cd	5	1.20
				1342	

Driver	Colour	3000K	4000K
EL.	○	1T5146EL	1T5148EL
EL.	●	1T5130EL	1T5132EL
DALI	○	1T5146DA	1T5148DA
DALI	●	1T5130DA	1T5132DA

LED / 33W / REFLECTOR / SP / CRI97



		3000K	H(m)	D(m)	E _{max} (lx)
		Ra97		14°	
Fixture Power	36W	1	0.24	25809	
Source Flux	3290lm	2	0.48	6452	
Fixture Flux	2796lm	3	0.72	2868	
Efficacy	78lm/W	4	0.96	1613	
TS951	I _{max} =7845cd/klm	I _{max}	25809cd	5	1.20
				1032	

Driver	Colour	3000K	4000K
EL.	○	1T5147EL	1T5149EL
EL.	●	1T5131EL	1T5133EL
DALI	○	1T5147DA	1T5149DA
DALI	●	1T5131DA	1T5133DA

LED / 33W / REFLECTOR / FL / CRI84



		3000K	H(m)	D(m)	E _{max} (lx)
		Ra84		27°	
Fixture Power	36W	1	0.49	13204	
Source Flux	4277lm	2	0.97	3301	
Fixture Flux	3622lm	3	1.46	1467	
Efficacy	101lm/W	4	1.95	825	
TS952	I _{max} =3087cd/klm	I _{max}	13204cd	5	2.43
				528	

Driver	Colour	3000K	4000K
EL.	○	1T5150EL	1T5152EL
EL.	●	1T5134EL	1T5136EL
DALI	○	1T5150DA	1T5152DA
DALI	●	1T5134DA	1T5136DA

STORE

LED / 33W / REFLECTOR / FL / CRI97



		3000K	H(m)	D(m)	Emax(lx)
Ra97				27°	
Fixture Power	36W	1	0.49	10157	
Source Flux	3290lm	2	0.97	2539	
Fixture Flux	2786lm	3	1.46	1129	
Efficacy	78lm/W	4	1.95	635	
TS952	Imax=3087cd/klm	Imax	10157cd	5	2.43

Driver	Colour	3000K	4000K
EL.	○	1T5151EL	1T5153EL
EL.	●	1T5135EL	1T5137EL
DALI	○	1T5151DA	1T5153DA
DALI	●	1T5135DA	1T5137DA

LED / 33W / REFLECTOR / MWFL / CRI84



		3000K	H(m)	D(m)	Emax(lx)
Ra84				45°	
Fixture Power	36W	1	0.82	6951	
Source Flux	4277lm	2	1.64	1738	
Fixture Flux	3716lm	3	2.46	772	
Efficacy	104lm/W	4	3.28	434	
TS953	Imax=1655cd/klm	Imax	7076cd	5	4.10

Driver	Colour	3000K	4000K
EL.	○	1T5154EL	1T5156EL
EL.	●	1T5138EL	1T5140EL
DALI	○	1T5154DA	1T5156DA
DALI	●	1T5138DA	1T5140DA

LED / 33W / REFLECTOR / MWFL / CRI97



		3000K	H(m)	D(m)	Emax(lx)
Ra97				45°	
Fixture Power	36W	1	0.82	5347	
Source Flux	3290lm	2	1.64	1337	
Fixture Flux	2859lm	3	2.46	594	
Efficacy	80lm/W	4	3.28	334	
TS953	Imax=1655cd/klm	Imax	5443cd	5	4.10

Driver	Colour	3000K	4000K
EL.	○	1T5155EL	1T5157EL
EL.	●	1T5139EL	1T5141EL
DALI	○	1T5155DA	1T5157DA
DALI	●	1T5139DA	1T5141DA

LED / 33W / REFLECTOR / WFL / CRI84

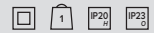

		3000K	H(m)	D(m)	Emax(lx)
Ra84				59°	
Fixture Power	36W	1	1.13	4836	
Source Flux	4277lm	2	2.26	1209	
Fixture Flux	3768lm	3	3.39	537	
Efficacy	106lm/W	4	4.51	302	
TS954	Imax=1142cd/klm	Imax	4882cd	5	5.64

Driver	Colour	3000K	4000K
EL.	○	1T5158EL	1T5160EL
EL.	●	1T5142EL	1T5144EL
DALI	○	1T5158DA	1T5160DA
DALI	●	1T5142DA	1T5144DA

LED / 33W / REFLECTOR / WFL / CRI97



		3000K	H(m)	D(m)	Emax(lx)
Ra97				59°	
Fixture Power	36W	1	1.13	3720	
Source Flux	3290lm	2	2.26	930	
Fixture Flux	2898lm	3	3.39	413	
Efficacy	81lm/W	4	4.51	233	
TS954	Imax=1142cd/klm	Imax	3756cd	5	5.64

Driver	Colour	3000K	4000K
EL.	○	1T5159EL	1T5161EL
EL.	●	1T5143EL	1T5145EL
DALI	○	1T5159DA	1T5161DA
DALI	●	1T5143DA	1T5145DA



Gimbal modules with magnets

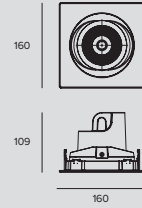

LED / 19W / REFLECTOR / SP / CRI84



		3000K	H(m)	D(m)	E _{max} (lx)	
		Ra84		14°		
Fixture Power	22W	1	0.24	23022		
Source Flux	2935lm	2	0.48	5755		
Fixture Flux	2494lm	3	0.72	2558		
Efficacy	112lm/W	4	0.96	1439		
TS947	I _{max} =7844cd/klm	I _{max}	23022cd	5	1.20	921

Driver	Colour	3000K	4000K
EL.	○	1T6445EL	1T6447EL
EL.	●	1T6429EL	1T6431EL
DALI	○	1T6445DA	1T6447DA
DALI	●	1T6429DA	1T6431DA

LED / 19W / REFLECTOR / SP / CRI97

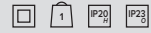

		3000K	H(m)	D(m)	E _{max} (lx)	
		Ra97		14°		
Fixture Power	22W	1	0.24	17704		
Source Flux	2257lm	2	0.48	4426		
Fixture Flux	1918lm	3	0.72	1967		
Efficacy	86lm/W	4	0.96	1106		
TS947	I _{max} =7844cd/klm	I _{max}	17704cd	5	1.20	708

Driver	Colour	3000K	4000K
EL.	○	1T6446EL	1T6448EL
EL.	●	1T6430EL	1T6432EL
DALI	○	1T6446DA	1T6448DA
DALI	●	1T6430DA	1T6432DA

LED / 19W / REFLECTOR / FL / CRI84

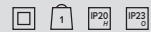

		3000K	H(m)	D(m)	E _{max} (lx)	
		Ra84		27°		
Fixture Power	22W	1	0.49	9061		
Source Flux	2935lm	2	0.97	2265		
Fixture Flux	2486lm	3	1.46	1007		
Efficacy	112lm/W	4	1.95	566		
TS948	I _{max} =3087cd/klm	I _{max}	9061cd	5	2.43	362

Driver	Colour	3000K	4000K
EL.	○	1T6449EL	1T6451EL
EL.	●	1T6433EL	1T6435EL
DALI	○	1T6449DA	1T6451DA
DALI	●	1T6433DA	1T6435DA

LED / 19W / REFLECTOR / FL / CRI97



		3000K	H(m)	D(m)	E _{max} (lx)	
		Ra97		27°		
Fixture Power	22W	1	0.49	6968		
Source Flux	2257lm	2	0.97	1742		
Fixture Flux	1912lm	3	1.46	774		
Efficacy	86lm/W	4	1.95	435		
TS948	I _{max} =3087cd/klm	I _{max}	6968cd	5	2.43	279

Driver	Colour	3000K	4000K
EL.	○	1T6450EL	1T6452EL
EL.	●	1T6434EL	1T6436EL
DALI	○	1T6450DA	1T6452DA
DALI	●	1T6434DA	1T6436DA

LED / 19W / REFLECTOR / MWFL / CRI84

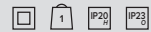

		3000K	H(m)	D(m)	E _{max} (lx)	
		Ra84		45°		
Fixture Power	22W	1	0.82	4770		
Source Flux	2935lm	2	1.64	1193		
Fixture Flux	2550lm	3	2.46	530		
Efficacy	115lm/W	4	3.28	298		
TS949	I _{max} =1655cd/klm	I _{max}	4856cd	5	4.10	191

Driver	Colour	3000K	4000K
EL.	○	1T6453EL	1T6455EL
EL.	●	1T6437EL	1T6439EL
DALI	○	1T6453DA	1T6455DA
DALI	●	1T6437DA	1T6439DA

STORE

LED / 19W / REFLECTOR / MWFL / CRI97

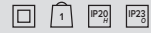

		3000K	H(m)	D(m)	Emax(lx)	
Ra97				45°		
Fixture Power	22W	1	0.82	3668		
Source Flux	2257lm	2	1.64	917		
Fixture Flux	1961lm	3	2.46	408		
Efficacy	88lm/W	4	3.28	229		
TS949	Imax=1655cd/klm	Imax	3734cd	5	4.10	147

Driver	Colour	3000K	4000K
EL.	○	1T6454EL	1T6456EL
EL.	●	1T6438EL	1T6440EL
DALI	○	1T6454DA	1T6456DA
DALI	●	1T6438DA	1T6440DA

LED / 19W / REFLECTOR / WFL / CRI84



		3000K	H(m)	D(m)	Emax(lx)	
Ra84				59°		
Fixture Power	22W	1	1.13	3318		
Source Flux	2935lm	2	2.26	830		
Fixture Flux	2585lm	3	3.39	369		
Efficacy	116lm/W	4	4.51	207		
TS950	Imax=1141cd/klm	Imax	3350cd	5	5.64	133

Driver	Colour	3000K	4000K
EL.	○	1T6457EL	1T6459EL
EL.	●	1T6441EL	1T6443EL
DALI	○	1T6457DA	1T6459DA
DALI	●	1T6441DA	1T6443DA

LED / 19W / REFLECTOR / WFL / CRI97

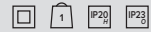

		3000K	H(m)	D(m)	Emax(lx)	
Ra97				59°		
Fixture Power	22W	1	1.13	2552		
Source Flux	2257lm	2	2.26	638		
Fixture Flux	1988lm	3	3.39	284		
Efficacy	90lm/W	4	4.51	159		
TS950	Imax=1141cd/klm	Imax	2576cd	5	5.64	102

Driver	Colour	3000K	4000K
EL.	○	1T6458EL	1T6460EL
EL.	●	1T6442EL	1T6444EL
DALI	○	1T6458DA	1T6460DA
DALI	●	1T6442DA	1T6444DA

LED / 33W / REFLECTOR / SP / CRI84

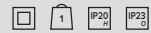

		3000K	H(m)	D(m)	Emax(lx)	
Ra84				14°		
Fixture Power	36W	1	0.24	33552		
Source Flux	4277lm	2	0.48	8388		
Fixture Flux	3635lm	3	0.72	3728		
Efficacy	102lm/W	4	0.96	2097		
TS951	Imax=7845cd/klm	Imax	33552cd	5	1.20	1342

Driver	Colour	3000K	4000K
EL.	○	1T6477EL	1T6479EL
EL.	●	1T6461EL	1T6463EL
DALI	○	1T6477DA	1T6479DA
DALI	●	1T6461DA	1T6463DA

LED / 33W / REFLECTOR / SP / CRI97



		3000K	H(m)	D(m)	Emax(lx)	
Ra97				14°		
Fixture Power	36W	1	0.24	25809		
Source Flux	3290lm	2	0.48	6452		
Fixture Flux	2796lm	3	0.72	2868		
Efficacy	78lm/W	4	0.96	1613		
TS951	Imax=7845cd/klm	Imax	25809cd	5	1.20	1032

Driver	Colour	3000K	4000K
EL.	○	1T6478EL	1T6480EL
EL.	●	1T6462EL	1T6464EL
DALI	○	1T6478DA	1T6480DA
DALI	●	1T6462DA	1T6464DA

LED / 33W / REFLECTOR / FL / CRI84



		3000K	H(m)	D(m)	Emax(lx)	
Ra84				27°		
Fixture Power	36W	1	0.49	13204		
Source Flux	4277lm	2	0.97	3301		
Fixture Flux	3622lm	3	1.46	1467		
Efficacy	101lm/W	4	1.95	825		
TS952	Imax=3087cd/klm	Imax	13204cd	5	2.43	528

Driver	Colour	3000K	4000K
EL.	○	1T6481EL	1T6483EL
EL.	●	1T6465EL	1T6467EL
DALI	○	1T6481DA	1T6483DA
DALI	●	1T6465DA	1T6467DA

LED / 33W / REFLECTOR / FL / CRI97



		3000K	H(m)	D(m)	E _{max} (lx)
Ra97				27°	
Fixture Power	36W	1	0.49	10157	
Source Flux	3290lm	2	0.97	2539	
Fixture Flux	2786lm	3	1.46	1129	
Efficacy	78lm/W	4	1.95	635	
TS952	I _{max} =3087cd/klm	I _{max}	10157cd	5	2.43

Driver	Colour	3000K	4000K
EL.	○	1T6482EL	1T6484EL
EL.	●	1T6466EL	1T6468EL
DALI	○	1T6482DA	1T6484DA
DALI	●	1T6466DA	1T6468DA

LED / 33W / REFLECTOR / MWFL / CRI84



		3000K	H(m)	D(m)	E _{max} (lx)
Ra84				45°	
Fixture Power	36W	1	0.82	6951	
Source Flux	4277lm	2	1.64	1738	
Fixture Flux	3716lm	3	2.46	772	
Efficacy	104lm/W	4	3.28	434	
TS953	I _{max} =1655cd/klm	I _{max}	7076cd	5	4.10

Driver	Colour	3000K	4000K
EL.	○	1T6485EL	1T6487EL
EL.	●	1T6469EL	1T6471EL
DALI	○	1T6485DA	1T6487DA
DALI	●	1T6469DA	1T6471DA

LED / 33W / REFLECTOR / MWFL / CRI97



		3000K	H(m)	D(m)	E _{max} (lx)
Ra97				45°	
Fixture Power	36W	1	0.82	5347	
Source Flux	3290lm	2	1.64	1337	
Fixture Flux	2859lm	3	2.46	594	
Efficacy	80lm/W	4	3.28	334	
TS953	I _{max} =1655cd/klm	I _{max}	5443cd	5	4.10

Driver	Colour	3000K	4000K
EL.	○	1T6486EL	1T6488EL
EL.	●	1T6470EL	1T6472EL
DALI	○	1T6486DA	1T6488DA
DALI	●	1T6470DA	1T6472DA

LED / 33W / REFLECTOR / WFL / CRI84



		3000K	H(m)	D(m)	E _{max} (lx)
Ra84				59°	
Fixture Power	36W	1	1.13	4836	
Source Flux	4277lm	2	2.26	1209	
Fixture Flux	3768lm	3	3.39	537	
Efficacy	106lm/W	4	4.51	302	
TS954	I _{max} =1142cd/klm	I _{max}	4882cd	5	5.64

Driver	Colour	3000K	4000K
EL.	○	1T6489EL	1T6491EL
EL.	●	1T6473EL	1T6475EL
DALI	○	1T6489DA	1T6491DA
DALI	●	1T6473DA	1T6475DA

LED / 33W / REFLECTOR / WFL / CRI97



		3000K	H(m)	D(m)	E _{max} (lx)
Ra97				59°	
Fixture Power	36W	1	1.13	3720	
Source Flux	3290lm	2	2.26	930	
Fixture Flux	2898lm	3	3.39	413	
Efficacy	81lm/W	4	4.51	233	
TS954	I _{max} =1142cd/klm	I _{max}	3756cd	5	5.64

Driver	Colour	3000K	4000K
EL.	○	1T6490EL	1T6492EL
EL.	●	1T6474EL	1T6476EL
DALI	○	1T6490DA	1T6492DA
DALI	●	1T6474DA	1T6476DA

Nota: Version with magnets to be complet with insertion box.

Related codes

Insertion Box

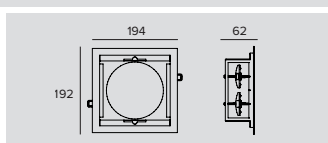

Cutout hole	Colour	Code
180x180	○	1T6496
180x180	●	1T6493

Frame 1x.

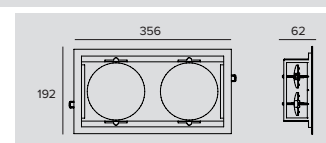

Cutout hole	Colour	Code
335x180	○	1T6497
335x180	●	1T6494

Frame 2x.

Recessed

STORE

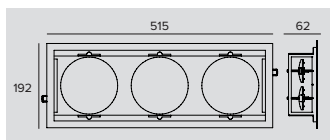

Cutout hole	Colour	Code
485x180	○	1T6498
485x180	●	1T6495

Frame 3x.

Accessories

Filter



Filter	Ø	Code
Red	70	1T1712
Green	70	1T1713
Blue	70	1T1714
Yellow	70	1T1715
Magenta	70	1T1716

Flat glass interference chromatic filter.
To be completed with an additional holder ring.

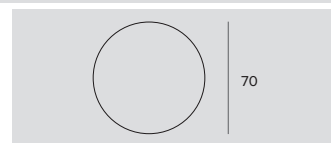

Ø	Code
70	1T1708

Flat striped glass blade light refractive filter.
This makes the beam take on an oval shape and when combined with spotlights, the light blade appears more prominent.
To be completed with an additional holder ring.

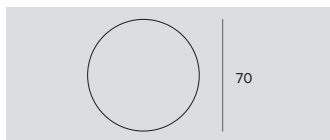

Ø	Code
70	1T1709

Flat glass wired refractive diffusive filter.
This softens the luminous effect.
To be completed with an additional holder ring.

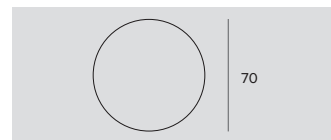

Filter	Ø	Code
Halogen +	70	1T6506
Vivid +	70	1T6507

Art filter.
Flat glass interference filter that can vary the colour parameters of the emission of the fixtures it is applied to.
To be used only with 3000K and Ra80 fixtures.
To be completed with an additional holder ring.

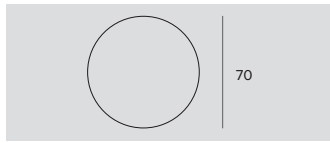

Filter	Ø	Code
Meat	70	1T6508
Fish	70	1T6509
Bread	70	1T6510
Vegetables	70	1T6511

Food filter.

Flat glass interference filter that can vary the colour parameters of the emission of the fixtures it is applied to.

To be completed with an additional holder ring.

1T6508

To be used only with 3000K and Ra80 fixtures.

1T6509

To be used only with 4000K and Ra80 fixtures.

1T6510

To be used only with 3000K and Ra80 fixtures.

1T6511

To be used only with 3000K and Ra80 fixtures.

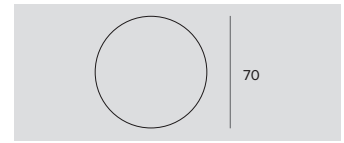

Filter	Ø	Code
Beauty	70	1T6512

Beauty filter.

Flat glass interference filter that can vary the colour parameters of the emission of the fixtures it is applied to.

To be used only with 3000K and Ra80 fixtures.

To be completed with an additional holder ring.

Screen

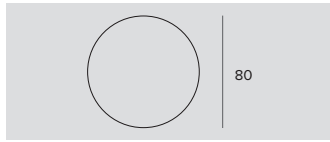

Ø	Code
80	1T6522

Protective screen.

Grid

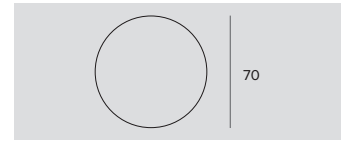

Ø	Code
70	1T1711

Anti-glare louver.

Black painted metal honeycomb structure.

To be completed with an additional holder ring for Cloud, Ray Mini, Store, Label 9 and Keplero Mini HE.

Zoom



Ø	Code
80	1T3432

Zoom.

Optical system consists of an optical glass flat convex lens, an anodized aluminium specular reflector and a diffusive holographic filter.

To be used after removing the existing optic.

It makes it possible to obtain a variable beam from 15° to 60°.

It can not be used with NSP and hybrid optics; no for DBS version.

Cut-off

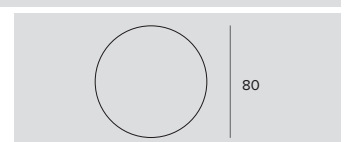

Ø	Code
80	1T3142

Cut-off Tube.

Allows for the beam to be focused while removing the fall-off component.

No for DBS version.

Screen



Ø	Code
80	1T3143

Black painted anodized diffusive aluminium asymmetric screen.

Complete with blade light filter.

Ideal for a Wall Washer effect.

To be combined with spot and flood optics.

Holder Ring

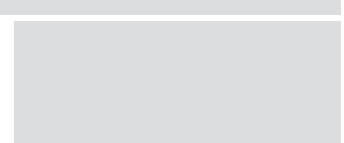

Code
1T3727

Transparent polycarbonate accessory holder ring.

STORE

Emergency Kit

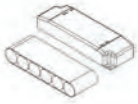

Code

1T3144

Emergency kit.
Inverter + 3h battery pack.
IP20.

Control systems



Code

1T5349

Wireless control unit for DALI fixtures.
It generates a local DALI bus that can control individual fixtures.
The module can be connected to an existing DALI network.
The module is wireless controlled using a Casambi app for smartphones and tablets using Bluetooth 4.0 technology.
The devices create a wireless mesh network that can control up to 128 fixtures.
IP20.



Code

1T5352

IP20 Extender for wireless control of DALI fixtures.
It generates a local DALI bus with the capacity to drive up to 64 fixtures.
Can control DALI fixtures in indoor applications.
It is also equipped with a relay that can control non-dimmable fixtures up to a maximum of 6A.



Mini Gimbal modules with springs

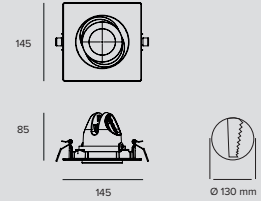

LED / 2,7W / LENS / NSP



		3000K	H(m)	D(m)	E _{max} (lx)
Ra80				9°	
Fixture Power	5W	1	0.15	4436	
Source Flux	200lm	2	0.30	1109	
Fixture Flux	163lm	3	0.45	493	
Efficacy	31lm/W	4	0.60	277	
TS965	I _{max} =22178cd/klm	I _{max}	4436cd	5	0.75
					177

Driver	Colour	3000K	4000K
EL.	○	1T4934EL	1T4935EL
EL.	●	1T4926EL	1T4927EL
DALI	○	1T4934DA	1T4935DA
DALI	●	1T4926DA	1T4927DA

LED / 11W / LENS / SP

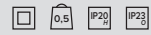

		3000K	H(m)	D(m)	E _{max} (lx)
Ra84				15°	
Fixture Power	15W	1	0.27	16914	
Source Flux	1786lm	2	0.53	4229	
Fixture Flux	1336lm	3	0.80	1879	
Efficacy	90lm/W	4	1.07	1057	
TS966	I _{max} =9470cd/klm	I _{max}	16914cd	5	1.33
					677

Driver	Colour	3000K	4000K
EL.	○	1T4936EL	1T4937EL
EL.	●	1T4928EL	1T4929EL
DALI	○	1T4936DA	1T4937DA
DALI	●	1T4928DA	1T4929DA

LED / 18W / LENS / SP

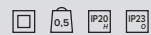

		3000K	H(m)	D(m)	E _{max} (lx)
Ra84				24°	
Fixture Power	20W	1	0.43	8803	
Source Flux	2466lm	2	0.87	2201	
Fixture Flux	1800lm	3	1.30	978	
Efficacy	89lm/W	4	1.73	550	
TS969	I _{max} =3570cd/klm	I _{max}	8803cd	5	2.17
					352

Driver	Colour	3000K	4000K
EL.	○	1T4948EL	1T4949EL
EL.	●	1T4942EL	1T4943EL
DALI	○	1T4948DA	1T4949DA
DALI	●	1T4942DA	1T4943DA

LED / 12W / LENS / FL



		3000K	H(m)	D(m)	E _{max} (lx)
Ra84				30°	
Fixture Power	14W	1	0.54	4825	
Source Flux	1837lm	2	1.09	1206	
Fixture Flux	1315lm	3	1.63	536	
Efficacy	97lm/W	4	2.17	302	
TS967	I _{max} =2627cd/klm	I _{max}	4825cd	5	2.72
					193

Driver	Colour	3000K	4000K
EL.	○	1T4938EL	1T4939EL
EL.	●	1T4930EL	1T4931EL
DALI	○	1T4938DA	1T4939DA
DALI	●	1T4930DA	1T4931DA

LED / 12W / REFLECTOR / MWFL

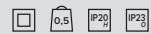

		3000K	H(m)	D(m)	E _{max} (lx)
Ra84				48°	
Fixture Power	14W	1	0.90	2476	
Source Flux	1837lm	2	1.80	619	
Fixture Flux	1520lm	3	2.69	275	
Efficacy	113lm/W	4	3.59	155	
TS968	I _{max} =1372cd/klm	I _{max}	2520cd	5	4.49
					99

Driver	Colour	3000K	4000K
EL.	○	1T4940EL	1T4941EL
EL.	●	1T4932EL	1T4933EL
DALI	○	1T4940DA	1T4941DA
DALI	●	1T4932DA	1T4933DA

STORE

LED / 18W / REFLECTOR / MWFL

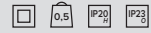

	3000K	H(m)	D(m)	E _{max} (lx)		
	Ra84		48°			
	Fixture Power	20W	1	0.90	3323	
	Source Flux	2466lm	2	1.80	831	
	Fixture Flux	2041lm	3	2.69	369	
	Efficacy	101lm/W	4	3.59	208	
TS970	I _{max} =1372cd/klm	I _{max}	3383cd	5	4.49	133

Driver	Colour	3000K	4000K
EL.	○	1T4950EL	1T4951EL
EL.	●	1T4944EL	1T4945EL
DALI	○	1T4950DA	1T4951DA
DALI	●	1T4944DA	1T4945DA

LED / 18W / REFLECTOR / WFL

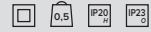

	3000K	H(m)	D(m)	E _{max} (lx)		
	Ra84		60°			
	Fixture Power	20W	1	1.16	2406	
	Source Flux	2466lm	2	2.32	601	
	Fixture Flux	1979lm	3	3.47	267	
	Efficacy	98lm/W	4	4.63	150	
TS971	I _{max} =976cd/klm	I _{max}	2407cd	5	5.79	96

Driver	Colour	3000K	4000K
EL.	○	1T4952EL	1T4953EL
EL.	●	1T4946EL	1T4947EL
DALI	○	1T4952DA	1T4953DA
DALI	●	1T4946DA	1T4947DA



Mini Gimbal modules with magnets

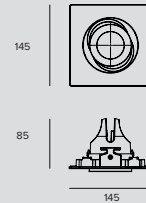

LED / 2,7W / LENS / NSP

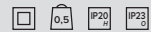

	3000K	H(m)	D(m)	E _{max} (lx)		
	Ra80		9°			
	Fixture Power	5W	1	0.15	4436	
	Source Flux	200lm	2	0.30	1109	
	Fixture Flux	163lm	3	0.45	493	
	Efficacy	31lm/W	4	0.60	277	
TS965	I _{max} =22178cd/klm	I _{max}	4436cd	5	0.75	177

Driver	Colour	3000K	4000K
EL.	○	1T5960EL	1T5961EL
EL.	●	1T5952EL	1T5953EL
DALI	○	1T5960DA	1T5961DA
DALI	●	1T5952DA	1T5953DA

LED / 11W / LENS / SP

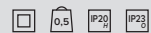

	3000K	H(m)	D(m)	E _{max} (lx)		
	Ra84		15°			
	Fixture Power	15W	1	0.27	16914	
	Source Flux	1786lm	2	0.53	4229	
	Fixture Flux	1336lm	3	0.80	1879	
	Efficacy	90lm/W	4	1.07	1057	
TS966	I _{max} =9470cd/klm	I _{max}	16914cd	5	1.33	677

Driver	Colour	3000K	4000K
EL.	○	1T5962EL	1T5963EL
EL.	●	1T5954EL	1T5955EL
DALI	○	1T5962DA	1T5963DA
DALI	●	1T5954DA	1T5955DA

LED / 18W / LENS / SP

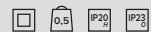

	3000K	H(m)	D(m)	E _{max} (lx)		
	Ra84		24°			
	Fixture Power	20W	1	0.43	8803	
	Source Flux	2466lm	2	0.87	2201	
	Fixture Flux	1800lm	3	1.30	978	
	Efficacy	89lm/W	4	1.73	550	
TS969	I _{max} =3570cd/klm	I _{max}	8803cd	5	2.17	352

Driver	Colour	3000K	4000K
EL.	○	1T5974EL	1T5975EL
EL.	●	1T5968EL	1T5969EL
DALI	○	1T5974DA	1T5975DA
DALI	●	1T5968DA	1T5969DA

LED / 12W / LENS / FL



		3000K	H(m)	D(m)	E _{max} (lx)
Ra84				30°	
Fixture Power	14W	1	0.54	4825	
Source Flux	1837lm	2	1.09	1206	
Fixture Flux	1315lm	3	1.63	536	
Efficacy	97lm/W	4	2.17	302	
TS967	I _{max} =2627cd/klm	I _{max}	4825cd	5	2.72
				193	

Driver	Colour	3000K	4000K
EL.	○	1T5964EL	1T5965EL
EL.	●	1T5956EL	1T5957EL
DALI	○	1T5964DA	1T5965DA
DALI	●	1T5956DA	1T5957DA

LED / 12W / REFLECTOR / MWFL



		3000K	H(m)	D(m)	E _{max} (lx)
Ra84				48°	
Fixture Power	14W	1	0.90	2476	
Source Flux	1837lm	2	1.80	619	
Fixture Flux	1520lm	3	2.69	275	
Efficacy	113lm/W	4	3.59	155	
TS968	I _{max} =1372cd/klm	I _{max}	2520cd	5	4.49
				99	

Driver	Colour	3000K	4000K
EL.	○	1T5966EL	1T5967EL
EL.	●	1T5958EL	1T5959EL
DALI	○	1T5966DA	1T5967DA
DALI	●	1T5958DA	1T5959DA

LED / 18W / REFLECTOR / MWFL



		3000K	H(m)	D(m)	E _{max} (lx)
Ra84				48°	
Fixture Power	20W	1	0.90	3323	
Source Flux	2466lm	2	1.80	831	
Fixture Flux	2041lm	3	2.69	369	
Efficacy	101lm/W	4	3.59	208	
TS970	I _{max} =1372cd/klm	I _{max}	3383cd	5	4.49
				133	

Driver	Colour	3000K	4000K
EL.	○	1T6419EL	1T6420EL
EL.	●	1T5970EL	1T5971EL
DALI	○	1T6419DA	1T6420DA
DALI	●	1T5970DA	1T5971DA

LED / 18W / REFLECTOR / WFL



		3000K	H(m)	D(m)	E _{max} (lx)
Ra84				60°	
Fixture Power	20W	1	1.16	2406	
Source Flux	2466lm	2	2.32	601	
Fixture Flux	1979lm	3	3.47	267	
Efficacy	98lm/W	4	4.63	150	
TS971	I _{max} =976cd/klm	I _{max}	2407cd	5	5.79
				96	

Driver	Colour	3000K	4000K
EL.	○	1T6421EL	1T6422EL
EL.	●	1T5972EL	1T5973EL
DALI	○	1T6421DA	1T6422DA
DALI	●	1T5972DA	1T5973DA

Nota: Version with magnets to be complet with insertion box.

Related codes

Insertion Box

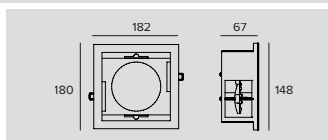

Cutout hole	Colour	Code
150x150	○	1T6426
150x150	●	1T6423

Frame 1x. For version with magnets.

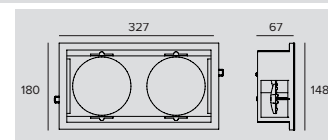

Cutout hole	Colour	Code
300x150	○	1T6427
300x150	●	1T6424

Frame 2x. For version with magnets.

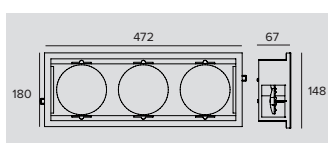

Cutout hole	Colour	Code
450x150	○	1T6428
450x150	●	1T6425

Frame 3x. For version with magnets.



Cutout hole	Code
149x149	1T7404

Trimless frame 1x. For version with springs.

STORE

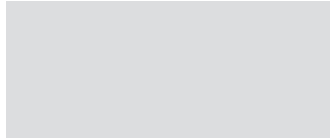
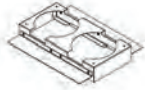

Cutout hole	Code
149x295	1T7405

Trimless frame 2x. For version with springs.

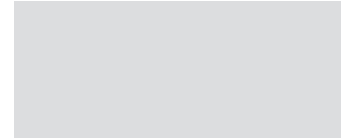
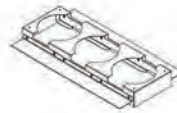

Cutout hole	Code
149x441	1T7406

Trimless frame 3x. For version with springs.

Accessories

Filter

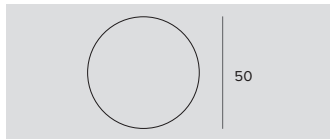

Filter	Ø	Code
Red	50	49881
Green	50	49882
Blue	50	49886
Yellow	50	49887
Magenta	50	49959

Flat glass interference chromatic filter.

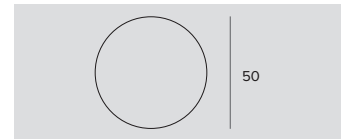

Ø	Code
50	1T4721

PMMA holographic filter with blade effect to ovalize the light beam; more evident when combined with spot and flood optics.



Filter	Ø	Code
Halogen +	50	1T6381
Vivid +	50	1T6383

Art filter.

Flat glass interference filter that can vary the colour parameters of the emission of the fixtures it is applied to.
To be used only with 3000K and Ra80 fixtures.

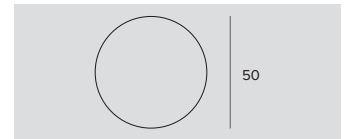

Filter	Ø	Code
Meat	50	1T6385
Fish	50	1T6387
Bread	50	1T6389
Vegetables	50	1T6391

Food filter.

Flat glass interference filter that can vary the colour parameters of the emission of the fixtures it is applied to.

1T6385
To be used only with 3000K and Ra80 fixtures.

1T6387
To be used only with 4000K and Ra80 fixtures.

1T6389
To be used only with 3000K and Ra80 fixtures.

1T6391
To be used only with 3000K and Ra80 fixtures.

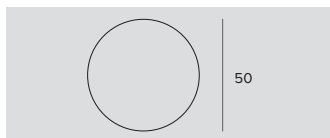

Filter	Ø	Code
Beauty	50	1T6393

Beauty filter.

Flat glass interference filter that can vary the colour parameters of the emission of the fixtures it is applied to.
To be used only with 3000K and Ra80 fixtures.

Screen

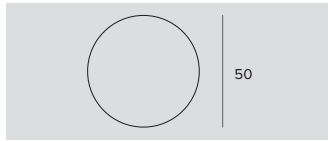

Ø Code
50 **1T4325**

Black painted anodized diffusive aluminium asymmetric screen.
Complete with blade light filter.
Ideal for a Wall Washer effect.
To be combined with spot and flood optics.

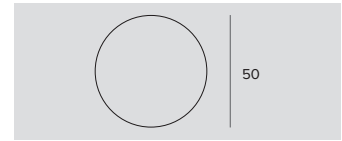

Ø Code
50 **1T6521**

Protective screen.

Grid

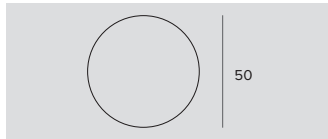

Ø Code
50 **1T4322**

Anti-glare louver.
Black painted metal honeycomb structure.
Complete with holographic diffusion filter.

Zoom

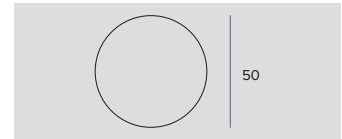

Ø Code
50 **1T4324**

Zoom.
Optical system consists of an optical glass flat convex lens, an anodized aluminium specular reflector and a diffusive holographic filter.
To be used after removing the existing optic.
It can not be used with a narrow spot optic.
It makes it possible to obtain a variable beam from 15° to 60°.

Emergency Kit

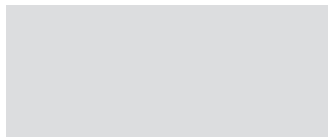
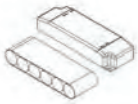

Code
1T3144

Emergency kit.
Inverter + 3h battery pack.
IP20.

Control systems

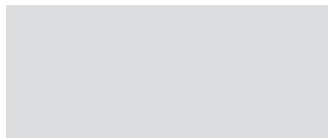

Code
1T5349

Wireless control unit for DALI fixtures.
It generates a local DALI bus that can control individual fixtures.
The module can be connected to an existing DALI network.
The module is wireless controlled using a Casambi app for smartphones and tablets using Bluetooth 4.0 technology.
The devices create a wireless mesh network that can control up to 128 fixtures.
IP20.

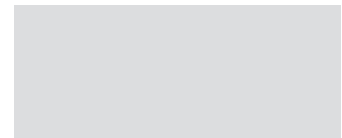

Code
1T5352

IP20 Extender for wireless control of DALI fixtures.
It generates a local DALI bus with the capacity to drive up to 64 fixtures.
Can control DALI fixtures in indoor applications.
It is also equipped with a relay that can control non-dimmable fixtures up to a maximum of 6A.

ZENO

Small extractable

GENERAL INFO

Recessed, extractable and adjustable LED professional projector.

The optical unit can be adjusted from 0 to 90° on the vertical plane and 360° on the horizontal plane with the possibility to block beam.

Ø105mm

LED

COB Chip on board
From 1430lm to 1692lm
3000K – 4000K
Ra97

PRODUCT EFFICACY

Up to 90lm/W

OPTICS

NSP – SP – FL – MWFL – WFL

POWER SUPPLY

Electronic – DALI
Casambi control: the DALI version is fitted with special accessories.

MATERIAL

Die-cast painted aluminium body.

A range of professional projectors especially for museum lighting, given the quality of the LED sources, the cutting edge optics and installation flexibility.

Also available in a projector version in three different sizes.

ZENO SMALL

Ø105mm

LED	Flux (lm)	1430- 1692
	Power	11W - 12W

OPTICS

NSP	Lens	•
SP	Lens	•
FL	Lens	•
MWFL	Reflector	•
WFL	Reflector	•



01



Trimless and complete with decorative ring

Recessed extractable fixture that can combine the flexibility of a projector with the ability to blend into the architecture.

Recessed

02



The optical body

To be moved into four different positions.

193



Small Extractable

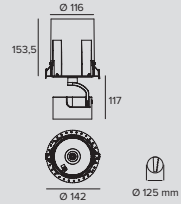

LED / 11W / LENS / NSP									
	3000K	H(m)	D(m)	Emax(lx)	Driver	Colour	3000K	4000K	
	Ra97		7°		EL.	○	1T6551EL	1T6552EL	
	Fixture Power	15W	1	0.13	24183	EL.	●	1T6553EL	1T6554EL
	Source Flux	1619lm	2	0.26	6046	DALI	○	1T6551DA	1T6552DA
	Fixture Flux	712lm	3	0.39	2687	DALI	●	1T6553DA	1T6554DA
	Efficacy	48lm/W	4	0.52	1511				
TS1063	Imax=14937cd/klm	Imax	24183cd	5	0.65	967			

LED / 12W / LENS / SP									
	3000K	H(m)	D(m)	Emax(lx)	Driver	Colour	3000K	4000K	
	Ra97		10°		EL.	○	1T6555EL	1T6556EL	
	Fixture Power	14W	1	0.18	17263	EL.	●	1T6557EL	1T6558EL
	Source Flux	1430lm	2	0.36	4316	DALI	○	1T6555DA	1T6556DA
	Fixture Flux	1101lm	3	0.54	1918	DALI	●	1T6557DA	1T6558DA
	Efficacy	82lm/W	4	0.72	1079				
TS1064	Imax=12072cd/klm	Imax	17263cd	5	0.89	691			

LED / 12W / LENS / FL									
	3000K	H(m)	D(m)	Emax(lx)	Driver	Colour	3000K	4000K	
	Ra97		28°		EL.	○	1T6559EL	1T6560EL	
	Fixture Power	14W	1	0.49	4536	EL.	●	1T6561EL	1T6562EL
	Source Flux	1430lm	2	0.99	1134	DALI	○	1T6559DA	1T6560DA
	Fixture Flux	1115lm	3	1.48	504	DALI	●	1T6561DA	1T6562DA
	Efficacy	83lm/W	4	1.98	284				
TS1065	Imax=3172cd/klm	Imax	4536cd	5	2.47	181			

LED / 12W / REFLECTOR / MWFL									
	3000K	H(m)	D(m)	Emax(lx)	Driver	Colour	3000K	4000K	
	Ra97		48°		EL.	○	1T6563EL	1T6564EL	
	Fixture Power	14W	1	0.90	1860	EL.	●	1T6565EL	1T6566EL
	Source Flux	1430lm	2	1.79	465	DALI	○	1T6563DA	1T6564DA
	Fixture Flux	1178lm	3	2.69	207	DALI	●	1T6565DA	1T6566DA
	Efficacy	87lm/W	4	3.59	116				
TS1066	Imax=1307cd/klm	Imax	1870cd	5	4.48	74			

LED / 12W / REFLECTOR / WFL									
	3000K	H(m)	D(m)	Emax(lx)	Driver	Colour	3000K	4000K	
	Ra97		58°		EL.	○	1T6567EL	1T6568EL	
	Fixture Power	14W	1	1.11	1400	EL.	●	1T6569EL	1T6570EL
	Source Flux	1430lm	2	2.21	350	DALI	○	1T6567DA	1T6568DA
	Fixture Flux	1188lm	3	3.32	156	DALI	●	1T6569DA	1T6570DA
	Efficacy	88lm/W	4	4.43	88				
TS1067	Imax=1001cd/klm	Imax	1432cd	5	5.53	56			

Related codes

Decorative Ring

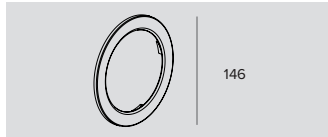

Ø	Colour	Code
146	○	1T6579
146	●	1T6580

Round ring.

Accessories

Filter

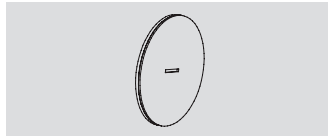

Code

1T6572

Blade of light filter.

Methacrylate holographic filter.

This makes the beam take on an oval shape and when combined with spotlights, the light blade appears more prominent.

To be completed with a dedicated holder ring.

Grid

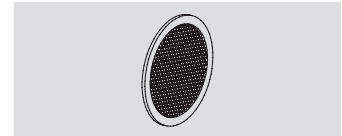

Code

1T6573

Anti-glare louver.

Black lacquered aluminium honeycomb structure.

To be completed with a dedicated holder ring.

Cut-off

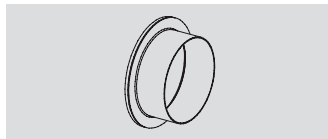

Code

1T6574

Black painted steel cut-off.

To be completed with a dedicated holder ring.

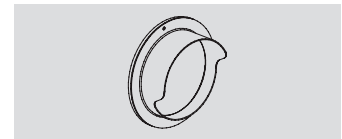

Code

1T6575

Black painted steel asymmetric cut-off.

To be completed with a dedicated holder ring.

Ray Shade



Code

1T6576

Adjustable barn door flaps made of black painted steel.

To be completed with a dedicated holder ring.

Holder Ring

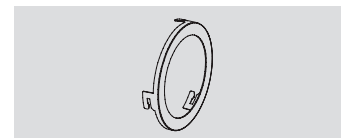

Colour

Code



1T6571

Black painted aluminium accessory holder ring.

Control systems



Code

1T5349

Wireless control unit for DALI fixtures.

It generates a local DALI bus that can control individual fixtures.

The module can be connected to an existing DALI network.

The module is wireless controlled using a Casambi app for smartphones and tablets using Bluetooth 4.0 technology.

The devices create a wireless mesh network that can control up to 128 fixtures.

IP20.



Code

1T5352

IP20 Extender for wireless control of DALI fixtures.

It generates a local DALI bus with the capacity to drive up to 64 fixtures.

Can control DALI fixtures in indoor applications.

It is also equipped with a relay that can control non-dimmable fixtures up to a maximum of 6A.

CLOUD

GENERAL INFO

Extractable recessed projectors
 CLOUD Ø108mm
 CLOUD MINI Ø73,5mm

LED

Chip on board
 From 1798lm to 7139lm
 3000K – 4000K
 Ra84
 Ra97 (only for large version)

PRODUCT EFFICACY

Up to 117lm/W

OPTICS

SP – FL – MWFL – WFL
 DBS - Digital beam opening control

POWER SUPPLY

Electronic – DALI – 1-10V
 Casambi control: DBS version Casambi on board. DALI version is fitted with special accessories.

MATERIAL

Extractable head and remote heat sink in die-cast aluminium painted in plaster white or deep black finish, with rotation system by friction on hinges. Removable front ring made of die-cast aluminium painted in plaster white or deep black finish for the insertion of dedicated optical accessories. Installation frame made of die-cast aluminium painted.

A range of recessed extractable projectors with different solutions in terms of size, lumens, colour temperature. CLOUD can be completely recessed for complete formal simplicity or extracted up to 75° to project light where it is needed.

It comes in two different sizes Cloud and Cloud Mini

		CLOUD	CLOUD MINI
		Ø 108mm	Ø 73.5mm
LED	Flux	3299-7139	1798-2550
	Power	25W-50W	11W-18W

OTTICHE

SP	Lenticolare		•
	Hybrid	•	
	Reflector	•	
FL	Lenticolare		•
	Hybrid	•	
	Reflector	•	
MWFL	Reflector	•	•
WFL	Reflector	•	•



01



Both the large and the small version

Are accessorised with a special Kicker that makes it possible to disappear into the false ceiling when the optical body is not fully extracted.

There is also a DBS - Dynamic Beam Shaper- version

For CLOUD Ra97 only.

02



The product can be adjusted vertically

From 75° to -25° for the CLOUD version and from 75° to -20° for the CLOUD MINI version making it possible to retract the optic



Venchi

Architect
Studio Ceri

Country
Florence - Italy

CLOUD

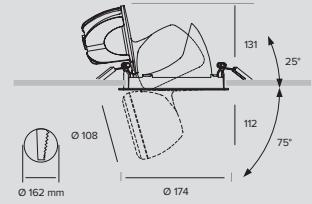

LED / 25W / REFLECTOR / SP / CR184 □ 1.7 IP20 ENEC

	3000K	H(m)	D(m)	Emax(lx)	
	Ra84		15°		
	Fixture Power	28W	1	0.26	24360
	Source Flux	3577lm	2	0.52	6090
	Fixture Flux	3040lm	3	0.77	2707
	Efficacy	109lm/W	4	1.03	1522

TS753	Imax=6810cd/klm	Imax	24360cd	5	1.29	974
-------	-----------------	------	---------	---	------	-----

Driver	Colour	3000K	4000K
EL.	○	1T3607EL	1T4112EL
EL.	●	1T3616EL	1T4114EL
1-10V	○	1T3607D	1T4112D
1-10V	●	1T3616D	1T4114D
DALI	○	1T3607DA	1T4112DA
DALI	●	1T3616DA	1T4114DA

LED / 39W / REFLECTOR / SP / CR184 □ 1.7 IP20 ENEC

	3000K	H(m)	D(m)	Emax(lx)	
	Ra84		15°		
	Fixture Power	42W	1	0.25	35015
	Source Flux	4920lm	2	0.51	8754
	Fixture Flux	4182lm	3	0.76	3891
	Efficacy	99lm/W	4	1.02	2188

TS755	Imax=7117cd/klm	Imax	35015cd	5	1.27	1401
-------	-----------------	------	---------	---	------	------

Driver	Colour	3000K	4000K
EL.	○	1T3609EL	1T4116EL
EL.	●	1T3618EL	1T4120EL
1-10V	○	1T3609D	1T4116D
1-10V	●	1T3618D	1T4120D
DALI	○	1T3609DA	1T4116DA
DALI	●	1T3618DA	1T4120DA

LED / 25W / REFLECTOR / FL / CR184 □ 1.7 IP20 ENEC

	3000K	H(m)	D(m)	Emax(lx)	
	Ra84		31°		
	Fixture Power	28W	1	0.55	8984
	Source Flux	3577lm	2	1.09	2246
	Fixture Flux	3028lm	3	1.64	998
	Efficacy	108lm/W	4	2.19	561

TS754	Imax=2512cd/klm	Imax	8984cd	5	2.73	359
-------	-----------------	------	--------	---	------	-----

Driver	Colour	3000K	4000K
EL.	○	1T3608EL	1T4113EL
EL.	●	1T3617EL	1T4115EL
1-10V	○	1T3608D	1T4113D
1-10V	●	1T3617D	1T4115D
DALI	○	1T3608DA	1T4113DA
DALI	●	1T3617DA	1T4115DA

LED / 39W / REFLECTOR / FL / CR184 □ 1.7 IP20 ENEC

	3000K	H(m)	D(m)	Emax(lx)	
	Ra84		28°		
	Fixture Power	42W	1	0.50	13675
	Source Flux	4920lm	2	1.01	3419
	Fixture Flux	4165lm	3	1.51	1519
	Efficacy	98lm/W	4	2.02	855

TS756	Imax=2779cd/klm	Imax	13675cd	5	2.52	547
-------	-----------------	------	---------	---	------	-----

Driver	Colour	3000K	4000K
EL.	○	1T3610EL	1T4117EL
EL.	●	1T3619EL	1T4121EL
1-10V	○	1T3610D	1T4117D
1-10V	●	1T3619D	1T4121D
DALI	○	1T3610DA	1T4117DA
DALI	●	1T3619DA	1T4121DA

LED / 50W / REFLECTOR / FL / CR184 □ 1.7 IP20 ENEC

	3000K	H(m)	D(m)	Emax(lx)	
	Ra84		36°		
	Fixture Power	54W	1	0.64	14555
	Source Flux	6959lm	2	1.29	3639
	Fixture Flux	5891lm	3	1.93	1617
	Efficacy	110lm/W	4	2.58	910

TS759	Imax=2092cd/klm	Imax	14555cd	5	3.22	582
-------	-----------------	------	---------	---	------	-----

Driver	Colour	3000K	4000K
EL.	○	1T3613EL	1T4124EL
EL.	●	1T3622EL	1T4127EL
1-10V	○	1T3613D	1T4124D
1-10V	●	1T3622D	1T4127D
DALI	○	1T3613DA	1T4124DA
DALI	●	1T3622DA	1T4127DA

CLOUD

LED / 39W / REFLECTOR / MWFL / CRI84

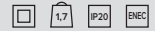

		3000K	H(m)	D(m)	E _{max} (lx)	
Ra84				43°		
Fixture Power	42W	1	0.79	8155		
Source Flux	4920lm	2	1.59	2039		
Fixture Flux	4275lm	3	2.38	906		
Efficacy	101lm/W	4	3.18	510		
TS757	I _{max} =1685cd/klm	I _{max}	8289cd	5	3.97	326

Driver	Colour	3000K	4000K
EL.	○	1T3611EL	1T4118EL
EL.	●	1T3620EL	1T4122EL
1-10V	○	1T3611D	1T4118D
1-10V	●	1T3620D	1T4122D
DALI	○	1T3611DA	1T4118DA
DALI	●	1T3620DA	1T4122DA

LED / 50W / REFLECTOR / MWFL / CRI84



		3000K	H(m)	D(m)	E _{max} (lx)	
Ra84				47°		
Fixture Power	54W	1	0.87	10238		
Source Flux	6959lm	2	1.75	2559		
Fixture Flux	6047lm	3	2.62	1138		
Efficacy	113lm/W	4	3.50	640		
TS760	I _{max} =1472cd/klm	I _{max}	10244cd	5	4.37	410

Driver	Colour	3000K	4000K
EL.	○	1T3614EL	1T4125EL
EL.	●	1T3623EL	1T4128EL
1-10V	○	1T3614D	1T4125D
1-10V	●	1T3623D	1T4128D
DALI	○	1T3614DA	1T4125DA
DALI	●	1T3623DA	1T4128DA

LED / 39W / REFLECTOR / WFL / CRI84



		3000K	H(m)	D(m)	E _{max} (lx)	
Ra84				57°		
Fixture Power	42W	1	1.08	5804		
Source Flux	4920lm	2	2.16	1451		
Fixture Flux	4330lm	3	3.24	645		
Efficacy	102lm/W	4	4.32	363		
TS758	I _{max} =1180cd/klm	I _{max}	5804cd	5	5.40	232

Driver	Colour	3000K	4000K
EL.	○	1T3612EL	1T4119EL
EL.	●	1T3621EL	1T4123EL
1-10V	○	1T3612D	1T4119D
1-10V	●	1T3621D	1T4123D
DALI	○	1T3612DA	1T4119DA
DALI	●	1T3621DA	1T4123DA

LED / 50W / REFLECTOR / WFL / CRI84

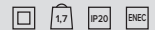

		3000K	H(m)	D(m)	E _{max} (lx)	
Ra84				59°		
Fixture Power	54W	1	1.13	7368		
Source Flux	6959lm	2	2.26	1842		
Fixture Flux	6124lm	3	3.40	819		
Efficacy	114lm/W	4	4.53	461		
TS761	I _{max} =1076cd/klm	I _{max}	7491cd	5	5.66	295

Driver	Colour	3000K	4000K
EL.	○	1T3615EL	1T4126EL
EL.	●	1T3624EL	1T4129EL
1-10V	○	1T3615D	1T4126D
1-10V	●	1T3624D	1T4129D
DALI	○	1T3615DA	1T4126DA
DALI	●	1T3624DA	1T4129DA

LED / 34W / HYBRID / SP / CRI97



		3000K	H(m)	D(m)	E _{max} (lx)	
Ra97				13°		
Fixture Power	37W	1	0.23	30351		
Source Flux	3299lm	2	0.46	7588		
Fixture Flux	2139lm	3	0.69	3372		
Efficacy	58lm/W	4	0.92	1897		
TS916	I _{max} =9200cd/klm	I _{max}	30351cd	5	1.14	1214

Driver	Colour	3000K	4000K
EL.	○	1T4791EL	
1-10V	○	1T4791D	
DALI	○	1T4791DA	

LED / 39W / REFLECTOR / SP / CRI97



		3000K	H(m)	D(m)	E _{max} (lx)	
Ra97				15°		
Fixture Power	42W	1	0.25	26931		
Source Flux	3784lm	2	0.51	6733		
Fixture Flux	3216lm	3	0.76	2992		
Efficacy	76lm/W	4	1.02	1683		
TS755	I _{max} =7117cd/klm	I _{max}	26931cd	5	1.27	1077

Driver	Colour	3000K	4000K
EL.	○	1T4297EL	
1-10V	○	1T4297D	
DALI	○	1T4297DA	

LED / 34W / HYBRID / FL / CRI97



		3000K	H(m)	D(m)	E _{max} (lx)
		Ra97			
				33°	
Fixture Power	37W	1	0.58	7356	
Source Flux	3299lm	2	1.17	1839	
Fixture Flux	2014lm	3	1.75	817	
Efficacy	54lm/W	4	2.33	460	
TS917	I _{max} =2230cd/klm	I _{max}	7356cd	5	2.92 294

Driver	Colour	3000K	4000K
EL.	○	1T4792EL	
1-10V	○	1T4792D	
DALI	○	1T4792DA	

LED / 39W / REFLECTOR / FL / CRI97

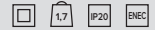

		3000K	H(m)	D(m)	E _{max} (lx)
		Ra97			
				28°	
Fixture Power	42W	1	0.50	10518	
Source Flux	3784lm	2	1.01	2629	
Fixture Flux	3203lm	3	1.51	1169	
Efficacy	76lm/W	4	2.02	657	
TS756	I _{max} =2779cd/klm	I _{max}	10518cd	5	2.52 421

Driver	Colour	3000K	4000K
EL.	○	1T4298EL	
1-10V	○	1T4298D	
DALI	○	1T4298DA	

LED / 50W / REFLECTOR / FL / CRI97

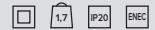

		3000K	H(m)	D(m)	E _{max} (lx)
		Ra97			
				36°	
Fixture Power	54W	1	0.64	11200	
Source Flux	5355lm	2	1.29	2800	
Fixture Flux	4533lm	3	1.93	1244	
Efficacy	85lm/W	4	2.58	700	
TS759	I _{max} =2092cd/klm	I _{max}	11200cd	5	3.22 448

Driver	Colour	3000K	4000K
EL.	○	1T4301EL	
1-10V	○	1T4301D	
DALI	○	1T4301DA	

LED / 39W / REFLECTOR / MWFL / CRI97

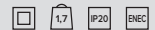

		3000K	H(m)	D(m)	E _{max} (lx)
		Ra97			
				43°	
Fixture Power	42W	1	0.79	6272	
Source Flux	3784lm	2	1.59	1568	
Fixture Flux	3288lm	3	2.38	697	
Efficacy	78lm/W	4	3.18	392	
TS757	I _{max} =1685cd/klm	I _{max}	6375cd	5	3.97 251

Driver	Colour	3000K	4000K
EL.	○	1T4299EL	
1-10V	○	1T4299D	
DALI	○	1T4299DA	

LED / 50W / REFLECTOR / MWFL / CRI97

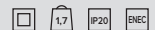

		3000K	H(m)	D(m)	E _{max} (lx)
		Ra97			
				47°	
Fixture Power	54W	1	0.87	7878	
Source Flux	5355lm	2	1.75	1970	
Fixture Flux	4653lm	3	2.62	875	
Efficacy	87lm/W	4	3.50	492	
TS760	I _{max} =1472cd/klm	I _{max}	7883cd	5	4.37 315

Driver	Colour	3000K	4000K
EL.	○	1T4302EL	
1-10V	○	1T4302D	
DALI	○	1T4302DA	

LED / 39W / REFLECTOR / WFL / CRI97



		3000K	H(m)	D(m)	E _{max} (lx)
		Ra97			
				57°	
Fixture Power	42W	1	1.08	4464	
Source Flux	3784lm	2	2.16	1116	
Fixture Flux	3330lm	3	3.24	496	
Efficacy	79lm/W	4	4.32	279	
TS758	I _{max} =1180cd/klm	I _{max}	4464cd	5	5.40 179

Driver	Colour	3000K	4000K
EL.	○	1T4300EL	
1-10V	○	1T4300D	
DALI	○	1T4300DA	

CLOUD

LED / 50W / REFLECTOR / WFL / CRI97

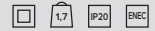

	3000K	H(m)	D(m)	E _{max} (lx)
Ra97			59°	
Fixture Power	54W	1	1.13	5670
Source Flux	5355lm	2	2.26	1418
Fixture Flux	4712lm	3	3.40	630
Efficacy	88lm/W	4	4.53	354
TS761	I _{max} =1076cd/klm	I _{max}	5764cd	5, 5.66, 227

Driver	Colour	3000K	4000K
EL	○	1T4303EL	
1-10V	○	1T4303D	
DALI	○	1T4303DA	

LED / 34W / DBS / CRI97



	3000K	H(m)	D(m)	E _{max} (lx)
Ra97			16°	
Fixture Power	37W	1	0.28	15397
Source Flux	3299lm	2	0.56	3849
Fixture Flux	1577lm	3	0.84	1711
Efficacy	42lm/W	4	1.12	962
TS1106	I _{max} =4667cd/klm	I _{max}	15397cd	5, 1.40, 616

Driver	Colour	3000K	4000K
CASAMBI	○	1T6950CA	

	3000K	H(m)	D(m)	E _{max} (lx)
Ra97			25°	
Fixture Power	37W	1	0.45	5921
Source Flux	3299lm	2	0.89	1480
Fixture Flux	1524lm	3	1.34	658
Efficacy	41lm/W	4	1.79	370
TS1107	I _{max} =1795cd/klm	I _{max}	5921cd	5, 2.24, 237

	3000K	H(m)	D(m)	E _{max} (lx)
Ra97			34°	
Fixture Power	37W	1	0.61	3248
Source Flux	3299lm	2	1.23	812
Fixture Flux	1481lm	3	1.84	361
Efficacy	40lm/W	4	2.45	203
TS1108	I _{max} =985cd/klm	I _{max}	3248cd	5, 3.07, 130

	3000K	H(m)	D(m)	E _{max} (lx)
Ra97			42°	
Fixture Power	37W	1	0.78	2047
Source Flux	3299lm	2	1.55	512
Fixture Flux	1405lm	3	2.33	227
Efficacy	38lm/W	4	3.11	128
TS1109	I _{max} =621cd/klm	I _{max}	2047cd	5, 3.88, 82

Accessories

Filter

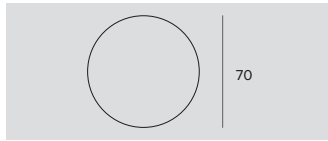

Filter	Ø	Code
Red	70	1T1712
Green	70	1T1713
Blue	70	1T1714
Yellow	70	1T1715
Magenta	70	1T1716

Flat glass interference chromatic filter.
To be completed with an additional holder ring.

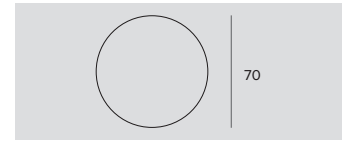

Filter	Ø	Code
	70	1T1708

Flat striped glass blade light refractive filter.
This makes the beam take on an oval shape and when combined with spotlights, the light blade appears more prominent.
To be completed with an additional holder ring.

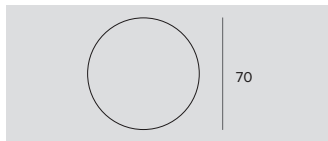

Filter	Ø	Code
	70	1T1709

Flat glass wired refractive diffusive filter.
This softens the luminous effect.
To be completed with an additional holder ring.

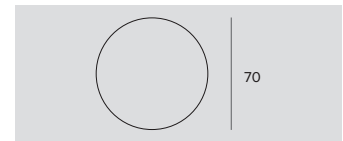

Filter	Ø	Code
Halogen +	70	1T6506
Vivid +	70	1T6507

Art filter.
Flat glass interference filter that can vary the colour parameters of the emission of the fixtures it is applied to.
To be used only with 3000K and Ra80 fixtures.
To be completed with an additional holder ring.

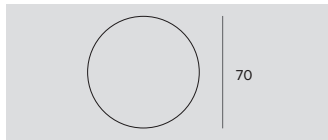

Filter	Ø	Code
Meat	70	1T6508
Fish	70	1T6509
Bread	70	1T6510
Vegetables	70	1T6511

Food filter.
Flat glass interference filter that can vary the colour parameters of the emission of the fixtures it is applied to.
To be completed with an additional holder ring.
1T6508
To be used only with 3000K and Ra80 fixtures.
1T6509
To be used only with 4000K and Ra80 fixtures.
1T6510
To be used only with 3000K and Ra80 fixtures.
1T6511
To be used only with 3000K and Ra80 fixtures.

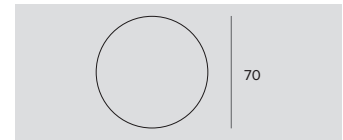

Filter	Ø	Code
Beauty	70	1T6512

Beauty filter.
Flat glass interference filter that can vary the colour parameters of the emission of the fixtures it is applied to.
To be used only with 3000K and Ra80 fixtures.
To be completed with an additional holder ring.

Screen

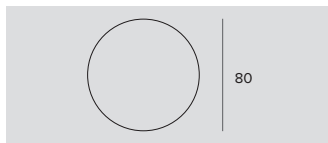

Screen	Ø	Code
	80	1T6522

Protective screen.

CLOUD

Grid



Ø Code
70 **1T1711**

Anti-glare louver.
Black painted metal honeycomb structure.
To be completed with an additional holder ring.

Zoom



Ø Code
80 **1T3432**

Zoom.
Optical system consists of an optical glass flat convex lens, an anodized aluminium specular reflector and a diffusive holographic filter.
To be used after removing the existing optic.
It makes it possible to obtain a variable beam from 15° to 60°.
It can not be used with NSP and hybrid optics; no for DBS version.

Cut-off

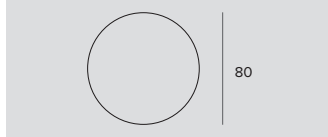

Ø Code
80 **1T3142**

Cut-off Tube.
Allows for the beam to be focused while removing the fall-off component.
No for DBS version.

Screen

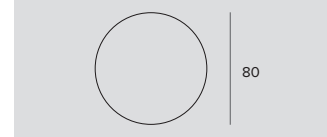

Ø Code
80 **1T3143**

Black painted anodized diffusive aluminium asymmetric screen.
Complete with blade light filter.
Ideal for a Wall Washer effect.
To be combined with spot and flood optics.

Holder Ring



Code
1T3727

Transparent polycarbonate accessory holder ring.

Emergency Kit

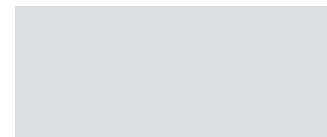

Code
1T3144

Emergency kit.
Inverter + 3h battery pack.
IP20.

Control systems

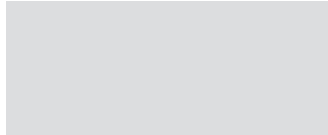

Code
1T5349

Wireless control unit for DALI fixtures.
It generates a local DALI bus that can control individual fixtures.
The module can be connected to an existing DALI network.
The module is wireless controlled using a Casambi app for smartphones and tablets using Bluetooth 4.0 technology.
The devices create a wireless mesh network that can control up to 128 fixtures.
IP20.

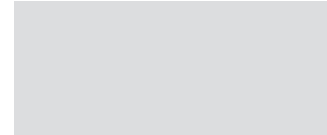

Code
1T5352

IP20 Extender for wireless control of DALI fixtures.
It generates a local DALI bus with the capacity to drive up to 64 fixtures.
Can control DALI fixtures in indoor applications.
It is also equipped with a relay that can control non-dimmable fixtures up to a maximum of 6A.



Mini

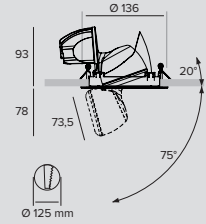

LED / 11W / LENS / SP □ 0.7 IP20 IP23

		3000K	H(m)	D(m)	E _{max} (lx)	
Ra84				15°		
Fixture Power	14W	1	0.27	16914		
Source Flux	1786lm	2	0.53	4229		
Fixture Flux	1336lm	3	0.80	1879		
Efficacy	98lm/W	4	1.07	1057		
TS844	Imax=9470cd/klm	Imax	16914cd	5	1.33	677

Driver	Colour	3000K	4000K
EL.	○	1T4216EL	1T4228EL
EL.	●	1T4217EL	1T4229EL
DALI	○	1T4216DA	1T4228DA
DALI	●	1T4217DA	1T4229DA

LED / 18W / LENS / SP □ 0.7 IP20 IP23

		3000K	H(m)	D(m)	E _{max} (lx)	
Ra84				24°		
Fixture Power	20W	1	0.43	8803		
Source Flux	2466lm	2	0.87	2201		
Fixture Flux	1800lm	3	1.30	978		
Efficacy	89lm/W	4	1.73	550		
TS847	Imax=3570cd/klm	Imax	8803cd	5	2.17	352

Driver	Colour	3000K	4000K
EL.	○	1T4222EL	1T4234EL
EL.	●	1T4223EL	1T4235EL
DALI	○	1T4222DA	1T4234DA
DALI	●	1T4223DA	1T4235DA

LED / 12W / LENS / FL □ 0.7 IP20 IP23

		3000K	H(m)	D(m)	E _{max} (lx)	
Ra84				30°		
Fixture Power	14W	1	0.54	4825		
Source Flux	1837lm	2	1.09	1206		
Fixture Flux	1315lm	3	1.63	536		
Efficacy	97lm/W	4	2.17	302		
TS845	Imax=2627cd/klm	Imax	4825cd	5	2.72	193

Driver	Colour	3000K	4000K
EL.	○	1T4218EL	1T4230EL
EL.	●	1T4219EL	1T4231EL
DALI	○	1T4218DA	1T4230DA
DALI	●	1T4219DA	1T4231DA

LED / 18W / LENS / FL □ 0.7 IP20 IP23

		3000K	H(m)	D(m)	E _{max} (lx)	
Ra84				30°		
Fixture Power	20W	1	0.54	6478		
Source Flux	2466lm	2	1.09	1620		
Fixture Flux	1766lm	3	1.63	720		
Efficacy	87lm/W	4	2.17	405		
TS932	Imax=2627cd/klm	Imax	6478cd	5	2.72	259

Driver	Colour	3000K	4000K
EL.	○	1T4793EL	1T4795EL
EL.	●	1T4794EL	1T4796EL
DALI	○	1T4793DA	1T4795DA
DALI	●	1T4794DA	1T4796DA

LED / 12W / REFLECTOR / MWFL □ 0.7 IP20 IP23

		3000K	H(m)	D(m)	E _{max} (lx)	
Ra84				48°		
Fixture Power	14W	1	0.90	2476		
Source Flux	1837lm	2	1.80	619		
Fixture Flux	1520lm	3	2.69	275		
Efficacy	113lm/W	4	3.59	155		
TS846	Imax=1372cd/klm	Imax	2520cd	5	4.49	99

Driver	Colour	3000K	4000K
EL.	○	1T4220EL	1T4232EL
EL.	●	1T4221EL	1T4233EL
DALI	○	1T4220DA	1T4232DA
DALI	●	1T4221DA	1T4233DA

CLOUD

LED / 18W / REFLECTOR / MWFL

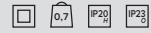

	3000K	H(m)	D(m)	E _{max} (lx)		
	Ra84		48°			
	Fixture Power	20W	1	0.90	3323	
	Source Flux	2466lm	2	1.80	831	
	Fixture Flux	2041lm	3	2.69	369	
	Efficacy	101lm/W	4	3.59	208	
TS848	I _{max} =1372cd/klm	I _{max}	3383cd	5	4.49	133

Driver	Colour	3000K	4000K
EL.	○	1T4224EL	1T4236EL
EL.	●	1T4225EL	1T4237EL
DALI	○	1T4224DA	1T4236DA
DALI	●	1T4225DA	1T4237DA

LED / 18W / REFLECTOR / WFL

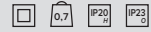

	3000K	H(m)	D(m)	E _{max} (lx)		
	Ra84		60°			
	Fixture Power	20W	1	1.16	2406	
	Source Flux	2466lm	2	2.32	601	
	Fixture Flux	1979lm	3	3.47	267	
	Efficacy	98lm/W	4	4.63	150	
TS849	I _{max} =976cd/klm	I _{max}	2407cd	5	5.79	96

Driver	Colour	3000K	4000K
EL.	○	1T4226EL	1T4238EL
EL.	●	1T4227EL	1T4239EL
DALI	○	1T4226DA	1T4238DA
DALI	●	1T4227DA	1T4239DA

Accessories

Filter

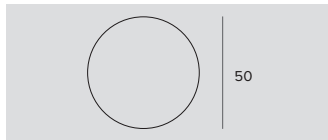

Filter	Ø	Code
Red	50	49881
Green	50	49882
Blue	50	49886
Yellow	50	49887
Magenta	50	49959

Flat glass interference chromatic filter.

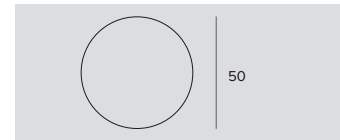

Filter	Ø	Code
Halogen +	50	1T6381
Vivid +	50	1T6383

Art filter.

Flat glass interference filter that can vary the colour parameters of the emission of the fixtures it is applied to.

To be used only with 3000K and Ra80 fixtures.

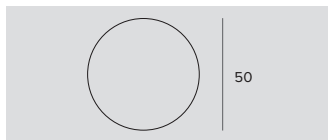

Filter	Ø	Code
Meat	50	1T6385
Fish	50	1T6387
Bread	50	1T6389
Vegetables	50	1T6391

Food filter.

Flat glass interference filter that can vary the colour parameters of the emission of the fixtures it is applied to.

1T6385

To be used only with 3000K and Ra80 fixtures.

1T6387

To be used only with 4000K and Ra80 fixtures.

1T6389

To be used only with 3000K and Ra80 fixtures.

1T6391

To be used only with 3000K and Ra80 fixtures.

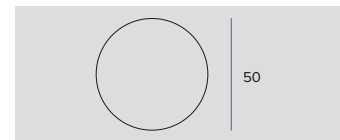

Filter	Ø	Code
Beauty	50	1T6393

Beauty filter.

Flat glass interference filter that can vary the colour parameters of the emission of the fixtures it is applied to.

To be used only with 3000K and Ra80 fixtures.

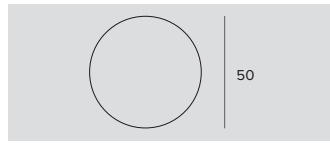

Ø Code
50 **1T4721**

PMMA holographic filter with blade effect to ovalize the light beam; more evident when combined with spot and flood optics.

Grid

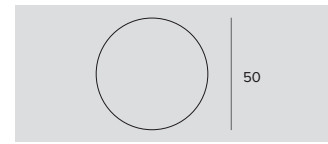

Ø Code
50 **1T4322**

Anti-glare louver.
Black painted metal honeycomb structure.
Complete with holographic diffusion filter.

Screen

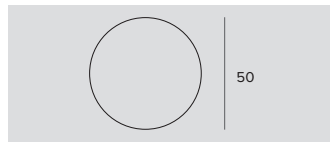

Ø Code
50 **1T6521**

Protective screen.

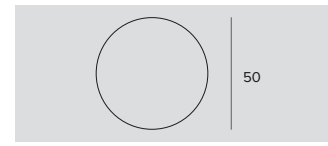

Ø Code
50 **1T4325**

Black painted anodized diffusive aluminium asymmetric screen.
Complete with blade light filter.
Ideal for a Wall Washer effect.
To be combined with spot and flood optics.

Zoom

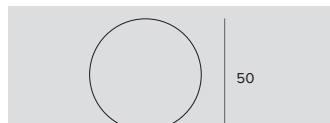

Ø Code
50 **1T4324**

Zoom.
Optical system consists of an optical glass flat convex lens, an anodized aluminium specular reflector and a diffusive holographic filter.
To be used after removing the existing optic.
It can not be used with a narrow spot optic.
It makes it possible to obtain a variable beam from 15° to 60°.

Emergency Kit

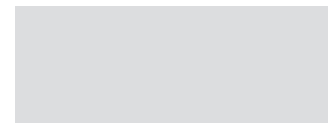
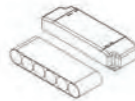

Code
1T3144

Emergency kit.
Inverter + 3h battery pack.
IP20.

Control systems

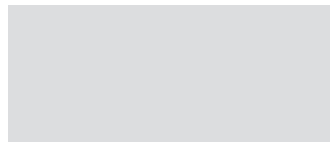

Code
1T5349

Wireless control unit for DALI fixtures.
It generates a local DALI bus that can control individual fixtures.
The module can be connected to an existing DALI network.
The module is wireless controlled using a Casambi app for smartphones and tablets using Bluetooth 4.0 technology.
The devices create a wireless mesh network that can control up to 128 fixtures.
IP20.

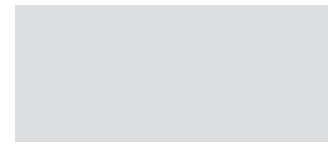

Code
1T5352

IP20 Extender for wireless control of DALI fixtures.
It generates a local DALI bus with the capacity to drive up to 64 fixtures.
Can control DALI fixtures in indoor applications.
It is also equipped with a relay that can control non-dimmable fixtures up to a maximum of 6A.

COZY

GENERAL INFO

Small recessed downlight, trimless (Ø55mm) or complete with decorative ring (Ø40mm).

LED

Chip on board
From 1798lm to 1855lm
3000K – 4000K
Ra84
Ra97 on request

PRODUCT EFFICACY

Up to 35lm/W

OPTIC

SP

POWER SUPPLY

Remote: Electronic - DALI
Casambi control: DALI driver fitted with special accessories.

MATERIAL

Polished aluminium body and integrated heat sink with painted flange. Painted, polished, removable front ring. The LED lamps are set back 40mm into the fixture to limit glare.

COZY is the smallest recessed downlight in the Targetti Collection. Just 40 mm in diameter (version with ring) it has an anti-glare solution thanks to the LED lamp that is set back 40mm from the emission surface.

The spot optic makes this recessed projector perfect for decorative accent lighting. Quick and easy system for installation in plasterboard ceilings of 5mm and more using AISI steel springs. There is also a double version with a visible or trimless finishing ring

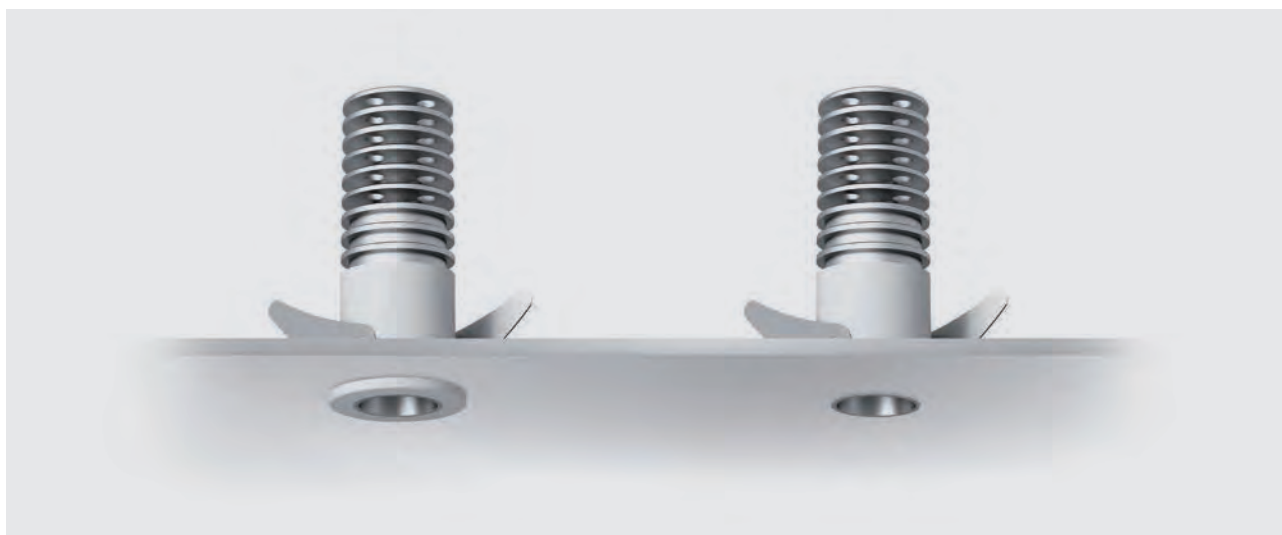



With ring

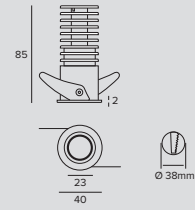

LED / 12W / SP



	3000K	H(m)	D(m)	E _{max} (lx)
Ra84			25*	
Fixture Power	14W	1	0.45	1814
Source Flux	1798lm	2	0.90	453
Fixture Flux	476lm	3	1.35	202
Efficacy	34lm/W	4	1.80	113
TS1044	I _{max} =1009cd/klm	I _{max}	1814cd	5
			2.25	73

Power supply	Colour	3000K	4000K
350mA	○	1T6377	1T6378
350mA	●	1T6379	1T6380



Trimless

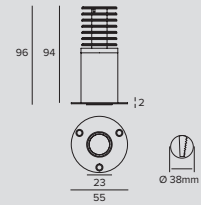

LED / 12W / SP



	3000K	H(m)	D(m)	E _{max} (lx)
Ra84			25*	
Fixture Power	14W	1	0.45	1814
Source Flux	1798lm	2	0.90	453
Fixture Flux	476lm	3	1.35	202
Efficacy	34lm/W	4	1.80	113
TS1044	I _{max} =1009cd/klm	I _{max}	1814cd	5
			2.25	73

Power supply	Colour	3000K	4000K
350mA	○	1T7400	1T7401

Related codes

Power Supply

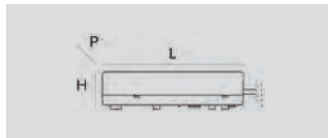

Code

Electronic power supply max 15W - 158x19x22mm	1T6505
DALI dimmable electronic power supply max 15W - 67x103x21mm*	1T6504

220-240V-AC 50-60Hz, 350mA - IP20.

*Driver's size is bigger than the cutout hole needed by the luminaire.

Emergency Kit

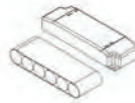

Code

1T3144

Emergency kit.
Inverter + 3h battery pack.

Control systems



Code

1T5349

A wireless control module with a DALI interface. It generates a local DALI bus which makes it possible to connect a LED driver directly to a DALI interface. The module can only be used in a closed system and cannot be connected to an existing DALI network. The module is wireless controlled using a Casambi app for smartphones and tablets using Bluetooth 4.0 technology. IP20



Code

1T5352

IP20 Extender for wireless control with DALI interfaces. It generates a local DALI bus with the capacity to drive up to 64 fixtures and can control groups of fixtures in indoor applications. It is also equipped with a relay that can control non-dimmable fixtures up to a maximum of 6A.

BEBOP

Recessed

GENERAL INFO

Recessed downlight
Ø90mm

LED

Chip on board
From 1302lm to 1909lm
3000K – 4000K
Ra84
Ra90 To order this version it is necessary to add the suffix "90" at the end of the standard code.

PRODUCT EFFICACY

Up to 88lm/W

OPTICS

MWFL - WFL

POWER SUPPLY

Electronic - DALI
Casambi control: the DALI version is fitted with special accessories.

MATERIAL

Painted polycarbonate body and rounded ring. Die-cast aluminium finned heat sink, side wiring complete with power supply.

A range of high performance characterised by simple, soft and rounded lines. Available in three different versions for ceiling mounted, suspension and recessed installation. In all versions the LED lamps are retracted and hidden from view to ensure optimum visual comfort. The flexible installation makes it possible to use the same type of light in environments with different architectural characteristics.

The recessed version has a reduced depth and a polycarbonate finishing ring with a white finish that "disappears" into ceilings creating the illusion of a plaster finish.





Recessed

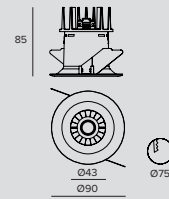

LED / 9W / MWFL										
		3000K		H(m)	D(m)	Driver		Colour	3000K	4000K
		Ra84		48°		EL.	○	1T4756EL	1T4757EL	
Fixture Power	12W	1	0.90	1391	EL.	●	1T5406EL	1T5407EL		
Source Flux	1302lm	2	1.79	348	DALI	○	1T4756DA	1T4757DA		
Fixture Flux	1000lm	3	2.69	155	DALI	●	1T5406DA	1T5407DA		
Efficacy	86lm/W	4	3.59	87						
TS897	Imax=1079cd/klm	Imax	1404cd	5	4.48	56				

LED / 9W / WFL										
		3000K		H(m)	D(m)	Driver		Colour	3000K	4000K
		Ra84		64°		EL.	○	1T4754EL	1T4755EL	
Fixture Power	12W	1	1.24	830	EL.	●	1T5408EL	1T5409EL		
Source Flux	1302lm	2	2.49	207	DALI	○	1T4754DA	1T4755DA		
Fixture Flux	980lm	3	3.73	92	DALI	●	1T5408DA	1T5409DA		
Efficacy	85lm/W	4	4.98	52						
TS896	Imax=688cd/klm	Imax	896cd	5	6.22	33				

LED / 15W / MWFL										
		3000K		H(m)	D(m)	Driver		Colour	3000K	4000K
		Ra84		48°		EL.	○	1T4760EL	1T4761EL	
Fixture Power	16W	1	0.90	1990	EL.	●	1T5410EL	1T5411EL		
Source Flux	1863lm	2	1.79	498	DALI	○	1T4760DA	1T4761DA		
Fixture Flux	1431lm	3	2.69	221	DALI	●	1T5410DA	1T5411DA		
Efficacy	87lm/W	4	3.59	124						
TS899	Imax=1079cd/klm	Imax	2010cd	5	4.48	80				

LED / 15W / WFL										
		3000K		H(m)	D(m)	Driver		Colour	3000K	4000K
		Ra84		64°		EL.	○	1T4758EL	1T4759EL	
Fixture Power	16W	1	1.24	1187	EL.	●	1T5412EL	1T5413EL		
Source Flux	1863lm	2	2.49	297	DALI	○	1T4758DA	1T4759DA		
Fixture Flux	1403lm	3	3.73	132	DALI	●	1T5412DA	1T5413DA		
Efficacy	86lm/W	4	4.98	74						
TS898	Imax=688cd/klm	Imax	1282cd	5	6.22	47				

Accessories

Emergency Kit	
Code	
	1T3144

Emergency kit.
Inverter + 3h battery pack.
IP20.

QUICKLED

GENERAL INFO

Compact recessed downlight
Ø85mm

LED

Chip on board
From 1302lm to 1909lm
3000K – 4000K
Ra84

PRODUCT EFFICACY

Up to 92lm/W

OPTICS

MWFL

POWER SUPPLY

Electronic - DALI
Casambi control: the DALI version is fitted with special accessories.

MATERIAL

Metallised polycarbonate body with decorative ring in anodised aluminium or painted white. Finned heat sink made of die-cast aluminium, side wiring complete with power supply.

A high performance compact downlight with excellent light distribution.

The special diffuser screen ensures extremely soft and homogeneous light distribution and also gives the fixture an IP44 rating making it suitable for installation in public spaces.



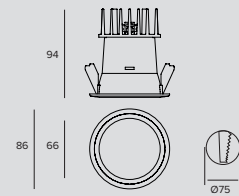

LED / 9W / MWFL									
		3000K	H(m)	D(m)	Emax(lx)	Driver	Colour	3000K	4000K
		Ra84		44°		EL.	○	1T4770EL	1T4771EL
Fixture Power	12W	1	0.81	1937	EL.	●	1T4772EL	1T4773EL	
Source Flux	1302lm	2	1.63	484	DALI	○	1T4770DA	1T4771DA	
Fixture Flux	1025lm	3	2.44	215	DALI	●	1T4772DA	1T4773DA	
Efficacy	88lm/W	4	3.26	121					
TS902	Imax=1488cd/klm	Imax	1937cd	5	4.07	77			

LED / 15W / MWFL									
		3000K	H(m)	D(m)	Emax(lx)	Driver	Colour	3000K	4000K
		Ra84		44°		EL.	○	1T4774EL	1T4775EL
Fixture Power	16W	1	0.81	2772	EL.	●	1T4776EL	1T4777EL	
Source Flux	1863lm	2	1.63	693	DALI	○	1T4774DA	1T4775DA	
Fixture Flux	1466lm	3	2.44	308	DALI	●	1T4776DA	1T4777DA	
Efficacy	89lm/W	4	3.26	173					
TS902	Imax=1488cd/klm	Imax	2772cd	5	4.07	111			

Accessories

Emergency Kit

Code

1T3144

Emergency kit.
Inverter + 3h battery pack.
IP20.

Control systems

Code

1T5349

Code

1T5352

Wireless control unit for DALI fixtures.
It generates a local DALI bus that can control individual fixtures.
The module can be connected to an existing DALI network.
The module is wireless controlled using a Casambi app for smartphones and tablets using Bluetooth 4.0 technology.
The devices create a wireless mesh network that can control up to 128 fixtures.
IP20.

IP20 Extender for wireless control of DALI fixtures.
It generates a local DALI bus with the capacity to drive up to 64 fixtures.
Can control DALI fixtures in indoor applications.
It is also equipped with a relay that can control non-dimmable fixtures up to a maximum of 6A.

POLKA

GENERAL INFO

Ultra compact LED recessed ceiling fixture.

MINI Ø36mm

FIX Ø77mm

FLEX Ø70mm

LED

Chip on board

From 59lm to 901lm

3000K

Ra80

PRODUCT EFFICACY

Up to 64lm/W

OPTICS

VWFL - MWFL

POWER SUPPLY

Remote electronic

MATERIAL

Aluminium body and ring to guarantee perfect heat dissipation. Available painted or brushed chrome finish with a circular or square decorative ring.

A series of high performance compact LED mini-recessed ceiling fixtures designed right down to the last detail.

Available in three different versions-MINI, FIX and FLEX- all of which are available with square or circular rings. The FLEX version is the smallest adjustable recessed fixture in the collection, precise and discrete for punctual and projected light. Adjustable to +/-22°.





Fix Round ring

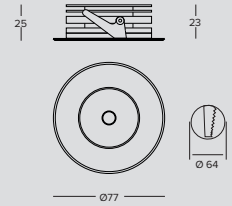

LED / 12W / VWFL



	3000K	H(m)	D(m)	E _{max} (lx)		
Ra80			108*			
Fixture Power	14W	1	2.75	364		
Source Flux	814lm	2	5.49	91		
Fixture Flux	814lm	3	8.24	40		
Efficacy	59lm/W	4	10.98	23		
TS765	I _{max} =447cd/klm	I _{max}	364cd	5	13.73	15

Power supply	Colour	3000K
350mA	○	1T3699
350mA	●	1T3700
350mA	●	1T6415



Fix Squared ring

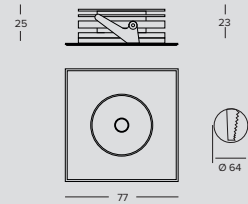

LED / 12W / VWFL

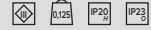

	3000K	H(m)	D(m)	E _{max} (lx)		
Ra80			108*			
Fixture Power	14W	1	2.75	364		
Source Flux	814lm	2	5.49	91		
Fixture Flux	814lm	3	8.24	40		
Efficacy	59lm/W	4	10.98	23		
TS765	I _{max} =447cd/klm	I _{max}	364cd	5	13.73	15

Power supply	Colour	3000K
350mA	○	1T3937
350mA	●	1T3938
350mA	●	1T6416

Related codes

Power Supply

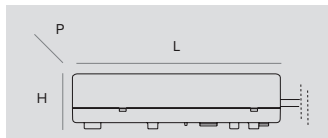

Code

1T1757

Electronic power supply 15W, LxHxP=119x22x52mm, 220-240V, 350mA, IP20.
For Polka Mini: can feed up to 10 fixtures connected in series in constant current; the driver is bigger than the cutout hole needed by the luminaire.

POLKA



Flex Round ring

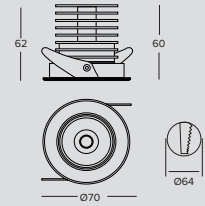

LED / 12W / MWFL								
	3000K	H(m)	D(m)	Emax(lx)	Power supply	Colour	3000K	
	Ra80		45°		350mA	○	1T3701	
	Fixture Power	14W	1	0.82	1479	350mA	●	1T3702
	Source Flux	901lm	2	1.64	370	350mA	●	1T6417
	Fixture Flux	901lm	3	2.46	164			
	Efficacy	64lm/W	4	3.28	92			
TS766	Imax=1641cd/klm	Imax	1479cd	5	4.10	59		



Flex Squared ring

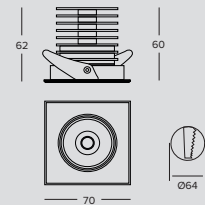

LED / 12W / MWFL								
	3000K	H(m)	D(m)	Emax(lx)	Power supply	Colour	3000K	
	Ra80		45°		350mA	○	1T3939	
	Fixture Power	14W	1	0.82	1479	350mA	●	1T3940
	Source Flux	901lm	2	1.64	370	350mA	●	1T6418
	Fixture Flux	901lm	3	2.46	164			
	Efficacy	64lm/W	4	3.28	92			
TS766	Imax=1641cd/klm	Imax	1479cd	5	4.10	59		

Related codes

Power Supply

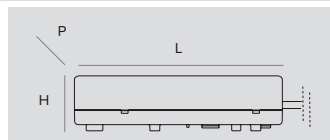

Code

1T1757

Electronic power supply 15W, LxHxP=119x22x52mm, 220-240V, 350mA, IP20.
For Polka Mini: can feed up to 10 fixtures connected in series in constant current; the driver is bigger than the cutout hole needed by the luminaire.



Mini Round ring

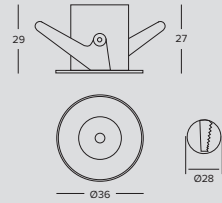

LED / 1,2W / VWFL								
	3000K	H(m)	D(m)	Emax(lx)	Power supply	Colour	3000K	
	Ra80		92°		350mA	○	1T3697	
	Fixture Power	2W	1	2.08	33	350mA	●	1T3698
	Source Flux	59lm	2	4.16	8	350mA	●	1T5422
	Fixture Flux	59lm	3	6.25	4			
	Efficacy	34lm/W	4	8.33	2			
TS767	Imax=571cd/klm	Imax	33cd	5	10.41	1		



Mini Squared ring

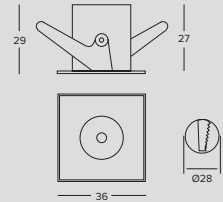

LED / 1,2W / VWFL								
	3000K	H(m)	D(m)	Emax(lx)	Power supply	Colour	3000K	
	Ra80		92°		350mA	○	1T3935	
	Fixture Power	2W	1	2.08	33	350mA	●	1T3936
	Source Flux	59lm	2	4.16	8	350mA	●	1T5423
	Fixture Flux	59lm	3	6.25	4			
	Efficacy	34lm/W	4	8.33	2			
TS767	Imax=571cd/klm	Imax	33cd	5	10.41	1		

Related codes

Power Supply

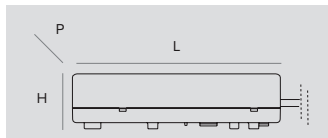

Code

1T1757

Electronic power supply 15W, LxHxP=119x22x52mm, 220-240V, 350mA, IP20.
For Polka Mini: can feed up to 10 fixtures connected in series in constant current; the driver is bigger than the cutout hole needed by the luminaire.

OTTO

Recessed

GENERAL INFO

Extractable recessed projector
Ø30mm

LED

LED Emitter
From 370lm to 397lm
3000K – 4000K
Ra84

PRODUCT EFFICACY

Up to 30lm/W

OPTIC

ZOOM: from SP to FL

POWER SUPPLY

Electronic remote

MATERIAL

Painted or anodised aluminium body.

A range of projectors with a minimal footprint with different installation types characterised by manual focus.

Available also in a single or multi-optical pole mounted version.





Semi-Recessed

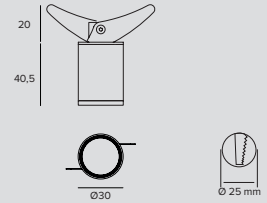

LED / 3W / ZOOM / SP-FL

		3000K	H(m)	D(m)	E _{max} (lx)	
		Ra84		14°		
Fixture Power	5W	1	0.24	2069		
Source Flux	370lm	2	0.49	517		
Fixture Flux	117lm	3	0.73	230		
Efficacy	23lm/W	4	0.98	129		
TS1039	I _{max} =5593cd/klm	I _{max}	2069cd	5	1.22	83

Power supply	Colour	3000K	4000K
1050mA	○	1T6335	1T6336
1050mA	●	1T6347	1T6348
1050mA	●	1T6359	1T6360

		3000K	H(m)	D(m)	E _{max} (lx)	
		Ra84		34°		
Fixture Power	5W	1	0.62	481		
Source Flux	370lm	2	1.23	120		
Fixture Flux	141lm	3	1.85	53		
Efficacy	28lm/W	4	2.46	30		
TS1040	I _{max} =1301cd/klm	I _{max}	481cd	5	3.08	19



Recessed extractable Extractable

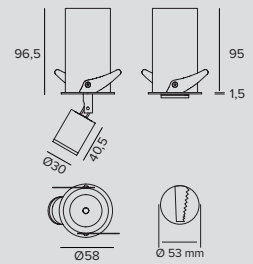

LED / 3W / ZOOM / SP-FL

		3000K	H(m)	D(m)	E _{max} (lx)	
		Ra84		14°		
Fixture Power	5W	1	0.24	2069		
Source Flux	370lm	2	0.49	517		
Fixture Flux	117lm	3	0.73	230		
Efficacy	23lm/W	4	0.98	129		
TS1039	I _{max} =5593cd/klm	I _{max}	2069cd	5	1.22	83

Power supply	Colour	3000K	4000K
1050mA	○	1T6333	1T6334
1050mA	●	1T6345	1T6346
1050mA	●	1T6357	1T6358

		3000K	H(m)	D(m)	E _{max} (lx)	
		Ra84		34°		
Fixture Power	5W	1	0.62	481		
Source Flux	370lm	2	1.23	120		
Fixture Flux	141lm	3	1.85	53		
Efficacy	28lm/W	4	2.46	30		
TS1040	I _{max} =1301cd/klm	I _{max}	481cd	5	3.08	19

Related codes

Power Supply

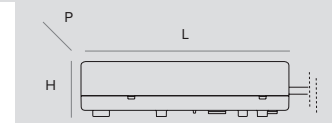

Code

1T6524

Electronic power supply 42W, LxHxP=129x30x42mm, 220-240V-AC 50-60Hz, 1050mA, IP20.

Can drive up to 12 OTTO 1x simultaneously.

OTTO Semi-Recessed: the driver is bigger than the cutout hole needed by the luminaire.

Indoor

Projectors

Track projectors



222
ZENO Large



229
ZENO Medium



233
ZENO Small



236
LABEL 6



238
LABEL 9



242
STORE



250
STORE Mini



254
LEDÒ



266
RAY



271
RAY Mini



276
RAY Micro



278
EUROSTANDARD
Plus

Surface projectors



284
JEDI
Compact

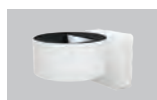

292
ZENO
Applique



296
VOLTA



302
CORO Large



317
CORO Small



324
OTTO
Base



328
OTTO
Multi-Optic

ZENO

GENERAL INFO

Professional LED projector.

The optical unit can be adjusted from 0 to -90° on the vertical plane; and 355° on the horizontal plane with aiming blocking system.

LARGE Ø184mm

MEDIUM Ø134mm

SMALL Ø105mm

LED

Chip on board

From 1430lm to 5121lm

3000K – 4000K

Ra97

PRODUCT EFFICACY

Up to 90lm/W

OPTICS

NSP – SP – FL – MWFL – WFL – WW

DBS - Digital beam opening control

POWER SUPPLY

Electronic – DALI - Casambi on board

MATERIAL

Die-cast painted aluminium optical unit and power supply body.

A range of professional projectors especially for museum lighting, given the quality of the LED sources, the cutting edge optics and installation flexibility.

Also available in an applique and recessed version.

		SMALL	MEDIUM	LARGE
		Ø105mm	Ø134mm	Ø184mm
LED	Flux (lm)	1430-1692	1881-2688	2463-5121
	Power	11W - 12W	18W - 26W	26W - 52W

OPTICS

NSP	Lens	•		
	Indirect		•	•
SP	Lens	•		
	Hybrid			•
FL	Lens	•		
	Hybrid		•	•
MWFL	Reflector	•	•	•
WFL	Reflector	•	•	•
WW	Reflector		•	•
DBS			•	•





Merendoni Palace

Photographer
Ivan Rossi

Country
Bologna - Italy

01



Designed around the LED source

It has six different optical systems for as many lighting effects, three installation types - projector, wall mounted and recessed -and three different sizes. Particularly innovative from the point of view of the optics, it includes the “indirect Narrow spot” optic that works on reflection and makes it possible to obtain extremely narrow (6°), clean and defined beams.

Also available in a DBS – Dynamic Beam Shaper

02



Design studied right down to the smallest detail

The proportions, depth reduced to a minimum while maintaining excellent heat dissipation, the shape of the distinctive bracket element that disappears and becomes an integral part of the power supply body, are just some of the characteristics of the range.



Great variety of optical accessories

Such as a Flap, Zoom, Cut-Off and corrective filters to satisfy even the most complex lighting requirements.



Zeno Large and Medium equipped with an indirect Narrow Spot optic

To obtain a clean, precise and extremely powerful beam. Great variety of optical accessories. It works by reflection which means the lamp is hidden from sight and aimed towards the parabolic reflector which collimates the beam and emits a particularly defined, precise cone of light. This makes it suitable for museum lighting or where defined, narrow beams with minimum fall-off are required.

Zeno Zoom

The ZOOM version is the most flexible in the Targetti collection; a single optical system with a "variable beam with continuity" from Spot (12°) to Flood (52°). The beam is changed manually, but no tools are needed. This lets you choose the best effect for your needs, where you need it. The telescopic optical system consists of an optical glass lens, internal reflector in specular anodised aluminium with very high reflectance, and PMMA front diffuser for precise and defined beams.

ZENO



Large NSP

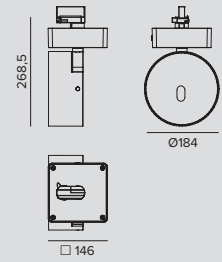

LED / 26W / INDIRECT / NSP

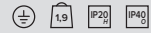

	3000K	H(m)	D(m)	Emax(lx)		
	Ra97		6*			
	Fixture Power	28W	1	0.11	121856	
	Source Flux	2463lm	2	0.22	30464	
	Fixture Flux	1736lm	3	0.33	13540	
	Efficacy	62lm/W	4	0.45	7616	
TS980	Imax=49475cd/klm	Imax	121856cd	5	0.56	4874

Driver	Colour	3000K	4000K
EL.	○	1T5377EL	1T5378EL
EL.	●	1T5379EL	1T5380EL
DALI	○	1T5377DA	1T5378DA
DALI	●	1T5379DA	1T5380DA
CASAMBI	○	1T5377DACA	1T5378DACA
CASAMBI	●	1T5379DACA	1T5380DACA



Large

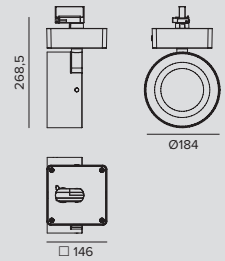

LED / 51W / HYBRID / SP



	3000K	H(m)	D(m)	Emax(lx)		
	Ra97		17*			
	Fixture Power	54W	1	0.30	26788	
	Source Flux	4985lm	2	0.60	6697	
	Fixture Flux	2842lm	3	0.89	2976	
	Efficacy	52lm/W	4	1.19	1674	
TS981	Imax=5374cd/klm	Imax	26788cd	5	1.49	1072

Driver	Colour	3000K	4000K
EL.	○	1T5381EL	1T5382EL
EL.	●	1T5383EL	1T5384EL
DALI	○	1T5381DA	1T5382DA
DALI	●	1T5383DA	1T5384DA
CASAMBI	○	1T5381DACA	1T5382DACA
CASAMBI	●	1T5383DACA	1T5384DACA

LED / 51W / HYBRID / FL

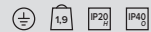

	3000K	H(m)	D(m)	Emax(lx)		
	Ra97		27*			
	Fixture Power	54W	1	0.47	15064	
	Source Flux	4985lm	2	0.94	3766	
	Fixture Flux	3194lm	3	1.42	1674	
	Efficacy	59lm/W	4	1.89	942	
TS982	Imax=3022cd/klm	Imax	15064cd	5	2.36	603

Driver	Colour	3000K	4000K
EL.	○	1T5385EL	1T5386EL
EL.	●	1T5387EL	1T5388EL
DALI	○	1T5385DA	1T5386DA
DALI	●	1T5387DA	1T5388DA
CASAMBI	○	1T5385DACA	1T5386DACA
CASAMBI	●	1T5387DACA	1T5388DACA

LED / 51W / REFLECTOR / MWFL

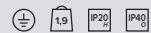

	3000K	H(m)	D(m)	Emax(lx)		
	Ra97		38*			
	Fixture Power	54W	1	0.69	7001	
	Source Flux	4985lm	2	1.38	1750	
	Fixture Flux	4088lm	3	2.07	778	
	Efficacy	75lm/W	4	2.76	438	
TS983	Imax=1417cd/klm	Imax	7066cd	5	3.44	280

Driver	Colour	3000K	4000K
EL.	○	1T5389EL	1T5390EL
EL.	●	1T5391EL	1T5392EL
DALI	○	1T5389DA	1T5390DA
DALI	●	1T5391DA	1T5392DA
CASAMBI	○	1T5389DACA	1T5390DACA
CASAMBI	●	1T5391DACA	1T5392DACA

LED / 51W / REFLECTOR / WFL

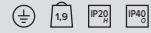

		3000K	H(m)	D(m)	E _{max} (lx)
Ra97				52°	
Fixture Power	54W	1	0.97	5123	
Source Flux	4985lm	2	1.94	1281	
Fixture Flux	4078lm	3	2.91	569	
Efficacy	75lm/W	4	3.88	320	
TS984	I _{max} =1028cd/klm	I _{max}	5123cd	5	4.85
				205	

Driver	Colour	3000K	4000K
EL.	○	1T5393EL	1T5394EL
EL.	●	1T5395EL	1T5396EL
DALI	○	1T5393DA	1T5394DA
DALI	●	1T5395DA	1T5396DA
CASAMBI	○	1T5393DACA	1T5394DACA
CASAMBI	●	1T5395DACA	1T5396DACA



Large WW

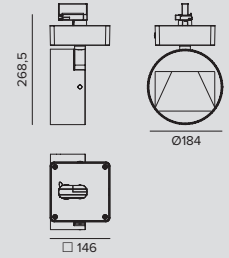

LED / 52W / WALL WASHER

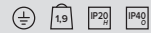

		3000K	H(m)	D1(m)	D2(m)	E _{max} (lx)
Ra97				34°	81°	
Fixture Power	56W	1	0.98	1.99	1761	
Source Flux	4995lm	2	1.96	3.98	440	
Fixture Flux	2413lm	3	2.94	5.96	196	
Efficacy	43lm/W	4	3.92	7.95	110	
TS985	I _{max} =520cd/klm	I _{max}	2599cd	5	4.91	9.94
				70		

Driver	Colour	3000K	4000K
EL.	○	1T5397EL	1T5398EL
EL.	●	1T5399EL	1T5400EL
DALI	○	1T5397DA	1T5398DA
DALI	●	1T5399DA	1T5400DA
CASAMBI	○	1T5397DACA	1T5398DACA
CASAMBI	●	1T5399DACA	1T5400DACA

Accessories

Filter

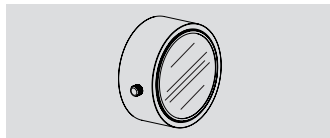

Code

1T6054

Methacrylate holographic filter. This makes the beam take on an oval shape and when combined with spotlights, the light blade appears more prominent. To be completed with a dedicated holder ring.

Grid

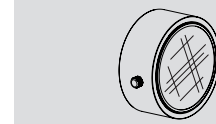

Code

1T6055

Anti-glare louver. Black lacquered aluminium honeycomb structure. To be completed with a dedicated holder ring.

Cut-off

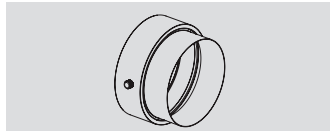

Code

1T6056

Black painted steel cut-off. To be completed with a dedicated holder ring.

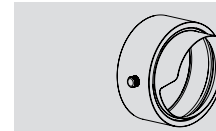

Code

1T6057

Black painted steel asymmetric cut-off. To be completed with a dedicated holder ring.

ZENO

Ray Shade



Code

1T6058

Adjustable barn doors flaps made of black painted steel.
To be completed with a dedicated holder ring.

Holder Ring

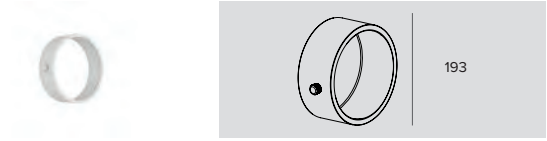

193

Code

1T6053



1T6500

Black painted aluminium accessory holder ring.ed aluminium accessory holder ring.

Adapter



Ø	H	Driver	Colour	Code
100	32	EL.	○	1T2221
100	32	EL.	●	1T2220
100	32	EL.	●	1T2219

Ceiling mounting adapter for electrified track type projectors.



Ø	H	Driver	Colour	Code
118	38	DALI	○	9000/BPU-D-W
118	38	DALI	●	9000/BPU-D-B
118	38	DALI	●	9000/BPU-D-G

Ceiling mounting adapter for electrified track type projectors.



Cutout hole	Ø	H	Driver	Colour	Code
Ø105/125	130	60	EL.	○	1T2223
Ø105/125	130	60	EL.	●	1T2222
Ø105/125	130	60	EL.	●	1T2224

Recessed mounting adapter for electrified track type projectors.

1T2222 - To be completed with 1T2220.

1T2223 - To be completed with 1T2221.

1T2224 - To be completed with 1T2219.

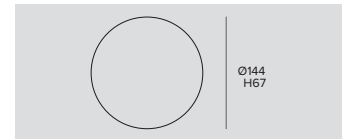

Cutout hole	Ø	H	Driver	Colour	Code
Ø125/130	144	67	DALI	○	9000/BRU-W
Ø125/130	144	67	DALI	●	9000/BRU-B
Ø125/130	144	67	DALI	●	9000/BRU-G

Recessed mounting adapter for electrified track type projectors.

9000/BRU-G - To be completed with 9000/BPU-D-G.

9000/BRU-W - To be completed with 9000/BPU-D-W.

9000/BRU-B - To be completed with 9000/BPU-D-B.



Medium NSP

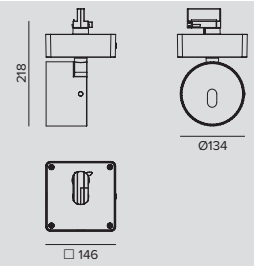

LED / 18W / INDIRECT / NSP

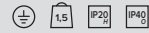

	3000K	H(m)	D(m)	Emax(lx)		
	Ra97		9°			
	Fixture Power	20W	1	0.16	29156	
	Source Flux	1881lm	2	0.33	7289	
	Fixture Flux	978lm	3	0.49	3240	
	Efficacy	48lm/W	4	0.65	1822	
TS974	Imax=15500cd/klm	Imax	29156cd	5	0.82	1166

Driver	Colour	3000K	4000K
EL.	○	1T5353EL	1T5354EL
EL.	●	1T5355EL	1T5356EL
DALI	○	1T5353DA	1T5354DA
DALI	●	1T5355DA	1T5356DA
CASAMBI	○	1T5353DACA	1T5354DACA
CASAMBI	●	1T5355DACA	1T5356DACA



Medium

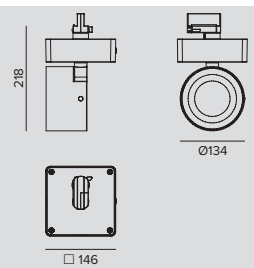

LED / 26W / HYBRID / SP



	3000K	H(m)	D(m)	Emax(lx)		
	Ra97		16°			
	Fixture Power	28W	1	0.27	17721	
	Source Flux	2602lm	2	0.55	4430	
	Fixture Flux	1735lm	3	0.82	1969	
	Efficacy	62lm/W	4	1.10	1108	
TS975	Imax=6811cd/klm	Imax	17721cd	5	1.37	709

Driver	Colour	3000K	4000K
EL.	○	1T5357EL	1T5358EL
EL.	●	1T5359EL	1T5360EL
DALI	○	1T5357DA	1T5358DA
DALI	●	1T5359DA	1T5360DA
CASAMBI	○	1T5357DACA	1T5358DACA
CASAMBI	●	1T5359DACA	1T5360DACA

LED / 26W / HYBRID / FL



	3000K	H(m)	D(m)	Emax(lx)		
	Ra97		32°			
	Fixture Power	28W	1	0.56	5622	
	Source Flux	2602lm	2	1.13	1405	
	Fixture Flux	1554lm	3	1.69	625	
	Efficacy	55lm/W	4	2.26	351	
TS976	Imax=2161cd/klm	Imax	5622cd	5	2.82	225

Driver	Colour	3000K	4000K
EL.	○	1T5361EL	1T5362EL
EL.	●	1T5363EL	1T5364EL
DALI	○	1T5361DA	1T5362DA
DALI	●	1T5363DA	1T5364DA
CASAMBI	○	1T5361DACA	1T5362DACA
CASAMBI	●	1T5363DACA	1T5364DACA

LED / 26W / REFLECTOR / MWFL



	3000K	H(m)	D(m)	Emax(lx)		
	Ra97		46°			
	Fixture Power	28W	1	0.84	3642	
	Source Flux	2602lm	2	1.68	911	
	Fixture Flux	2128lm	3	2.52	405	
	Efficacy	76lm/W	4	3.37	228	
TS977	Imax=1417cd/klm	Imax	3687cd	5	4.21	146

Driver	Colour	3000K	4000K
EL.	○	1T5365EL	1T5366EL
EL.	●	1T5367EL	1T5368EL
DALI	○	1T5365DA	1T5366DA
DALI	●	1T5367DA	1T5368DA
CASAMBI	○	1T5365DACA	1T5366DACA
CASAMBI	●	1T5367DACA	1T5368DACA

ZENO

LED / 26W / REFLECTOR / WFL

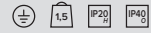

		3000K	H(m)	D(m)	E _{max} (lx)
Ra97				59°	
Fixture Power	28W	1	1.12	2590	
Source Flux	2602lm	2	2.24	648	
Fixture Flux	2136lm	3	3.36	288	
Efficacy	76lm/W	4	4.48	162	
TS978	Imax=996cd/klm Imax	2592cd	5	5.60	104

Driver	Colour	3000K	4000K
EL.	○	1T5369EL	1T5370EL
EL.	●	1T5371EL	1T5372EL
DALI	○	1T5369DA	1T5370DA
DALI	●	1T5371DA	1T5372DA
CASAMBI	○	1T5369DACA	1T5370DACA
CASAMBI	●	1T5371DACA	1T5372DACA



Medium

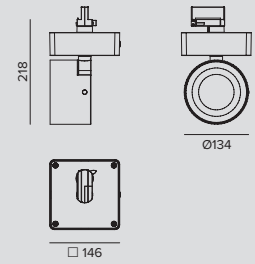

LED / 26W / DBS



		3000K	H(m)	D(m)	E _{max} (lx)
Ra97				16°	
Fixture Power	28W	1	0.28	12144	
Source Flux	2602lm	2	0.56	3036	
Fixture Flux	1244lm	3	0.84	1349	
Efficacy	44lm/W	4	1.12	759	
TS1096	Imax=4667cd/klm Imax	12144cd	5	1.40	486

Driver	Colour	3000K	4000K
CASAMBI	○	1T6941CA	1T6943CA
CASAMBI	●	1T6942CA	1T6944CA

		3000K	H(m)	D(m)	E _{max} (lx)
Ra97				25°	
Fixture Power	28W	1	0.45	4670	
Source Flux	2602lm	2	0.89	1167	
Fixture Flux	1202lm	3	1.34	519	
Efficacy	43lm/W	4	1.79	292	
TS1097	Imax=1795cd/klm Imax	4670cd	5	2.24	187

		3000K	H(m)	D(m)	E _{max} (lx)
Ra97				42°	
Fixture Power	28W	1	0.78	1615	
Source Flux	2602lm	2	1.55	404	
Fixture Flux	1108lm	3	2.33	179	
Efficacy	40lm/W	4	3.11	101	
TS1099	Imax=620cd/klm Imax	1615cd	5	3.88	65

		3000K	H(m)	D(m)	E _{max} (lx)
Ra97				34°	
Fixture Power	28W	1	0.61	2562	
Source Flux	2602lm	2	1.23	640	
Fixture Flux	1168lm	3	1.84	285	
Efficacy	42lm/W	4	2.45	160	
TS1098	Imax=984cd/klm Imax	2562cd	5	3.07	102



Medium WW

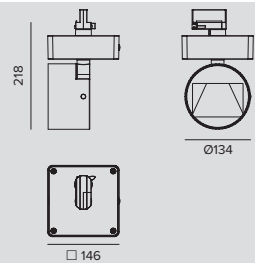

LED / 26W / WALL WASHER



		3000K	H(m)	D1(m)	D2(m)	E _{max} (lx)
Ra97				34°	54°	
Fixture Power	28W	1	1.06	1.18	1345	
Source Flux	2602lm	2	2.11	2.35	336	
Fixture Flux	1473lm	3	3.17	3.53	149	
Efficacy	53lm/W	4	4.23	4.71	84	
TS979	Imax=745cd/klm Imax	1939cd	5	5.28	5.89	54

Driver	Colour	3000K	4000K
EL.	○	1T5373EL	1T5374EL
EL.	●	1T5375EL	1T5376EL
DALI	○	1T5373DA	1T5374DA
DALI	●	1T5375DA	1T5376DA
CASAMBI	○	1T5373DACA	1T5374DACA
CASAMBI	●	1T5375DACA	1T5376DACA

Accessories

Filter



Code
1T6060

Methacrylate holographic filter.
This makes the beam take on an oval shape and when combined with spotlights, the light blade appears more prominent.
To be completed with a dedicated holder ring.

Grid



Code
1T6061

Anti-glare louver.
Black lacquered aluminium honeycomb structure.
To be completed with a dedicated holder ring.

Cut-off

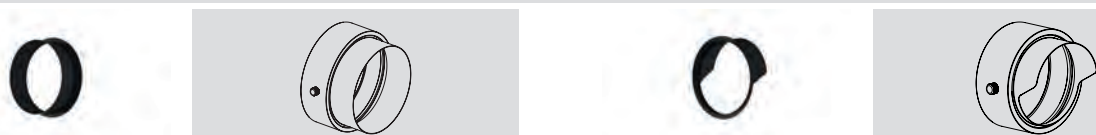

Code
1T6062

Code
1T6063

Black painted steel cut-off.
To be completed with a dedicated holder ring.

Black painted steel asymmetric cut-off.
To be completed with a dedicated holder ring.

Ray Shade



Code
1T6064

Adjustable barn doors flaps made of black painted steel.
To be completed with a dedicated holder ring.

Holder Ring



142,5

Colour	Code
	1T6059
	1T6501

Black painted aluminium accessory holder ring.

Adapter

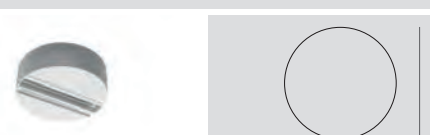

Ø	H	Driver	Colour	Code
100	32	EL.		1T2221
100	32	EL.		1T2220
100	32	EL.		1T2219

Ceiling mounting adapter for electrified track type projectors.



Ø	H	Driver	Colour	Code
118	38	DALI		9000/BPU-D-W
118	38	DALI		9000/BPU-D-B
118	38	DALI		9000/BPU-D-G

Ceiling mounting adapter for electrified track type projectors.



Cutout hole	Ø	H	Driver	Colour	Code
Ø105/125	130	60	EL.		1T2223
Ø105/125	130	60	EL.		1T2222
Ø105/125	130	60	EL.		1T2224

Recessed mounting adapter for electrified track type projectors.
1T2222 - To be completed with 1T2220.
1T2223 - To be completed with 1T2221.
1T2224 - To be completed with 1T2219.



Cutout hole	Ø	H	Driver	Colour	Code
Ø125/130	144	67	DALI		9000/BRU-W
Ø125/130	144	67	DALI		9000/BRU-B
Ø125/130	144	67	DALI		9000/BRU-G

Recessed mounting adapter for electrified track type projectors.
9000/BRU-G - To be completed with 9000/BPU-D-G.
9000/BRU-W - To be completed with 9000/BPU-D-W.
9000/BRU-B - To be completed with 9000/BPU-D-B.

ZENO



Medium Zoom

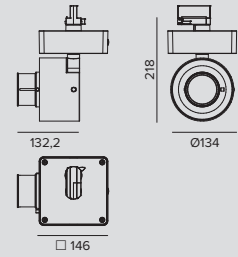

LED / 26W / ZOOM / SP-WFL										
	3000K	H(m)	D(m)	Emax(lx)		Driver	Colour	3000K	4000K	
	Ra97		12°			EL.	○	1T7502EL	1T7504EL	
	Fixture Power	29W	1	0.21	11345	EL.	●	1T7503EL	1T7505EL	
	Source Flux	2559lm	2	0.42	2836	DALI	○	1T7502DA	1T7504DA	
	Fixture Flux	599lm	3	0.62	1261	DALI	●	1T7503DA	1T7505DA	
	Efficacy	21lm/W	4	0.83	709	CASAMBI	○	1T7502DACA	1T7504DACA	
TS1179	Imax=4433cd/klm	Imax	11345cd	5	1.04	454	CASAMBI	●	1T7503DACA	1T7505DACA
	3000K	H(m)	D(m)	Emax(lx)						
	Ra97		52°							
	Fixture Power	29W	1	0.98	2160					
	Source Flux	2559lm	2	1.96	540					
	Fixture Flux	1581lm	3	2.95	240					
	Efficacy	55lm/W	4	3.93	135					
TS1180	Imax=883cd/klm	Imax	2260cd	5	4.91	86				

Accessories

Adapter					
		Ø100 H32			
Ø	H	Driver	Colour	Code	
100	32	EL.	○	1T2221	
100	32	EL.	●	1T2220	
100	32	EL.	●	1T2219	
		Ø130 H60			
Cutout hole	Ø	H	Driver	Colour	Code
Ø105/125	130	60	EL.	○	1T2223
Ø105/125	130	60	EL.	●	1T2222
Ø105/125	130	60	EL.	●	1T2224

Recessed mounting adapter for electrified track type projectors.
1T2222 - To be completed with 1T2220.
1T2223 - To be completed with 1T2221.
1T2224 - To be completed with 1T2219.

Ceiling mounting adapter for electrified track type projectors.

		Ø118 H38			
Ø	H	Driver	Colour	Code	
118	38	DALI	○	9000/BRU-D-W	
118	38	DALI	●	9000/BRU-D-B	
118	38	DALI	●	9000/BRU-D-G	
		Ø144 H67			
Cutout hole	Ø	H	Driver	Colour	Code
Ø125/130	144	67	DALI	○	9000/BRU-W
Ø125/130	144	67	DALI	●	9000/BRU-B
Ø125/130	144	67	DALI	●	9000/BRU-G

Recessed mounting adapter for electrified track type projectors.
9000/BRU-G - To be completed with 9000/BPU-D-G.
9000/BRU-W - To be completed with 9000/BPU-D-W.
9000/BRU-B - To be completed with 9000/BPU-D-B.

Ceiling mounting adapter for electrified track type projectors.



Small

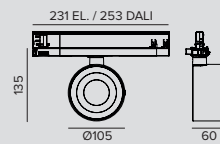

LED / 11W / LENS / NSP



		3000K	H(m)	D(m)	E _{max} (lx)	
Ra97				7°		
Fixture Power	15W	1	0.13	24183		
Source Flux	1619lm	2	0.26	6046		
Fixture Flux	712lm	3	0.39	2687		
Efficacy	48lm/W	4	0.52	1511		
TS1063	I _{max} =14937cd/klm	I _{max}	24183cd	5	0.65	967

Driver	Colour	3000K	4000K
EL.	○	1T6531EL	1T6532EL
EL.	●	1T6533EL	1T6534EL
DALI	○	1T6531DA	1T6532DA
DALI	●	1T6533DA	1T6534DA

LED / 12W / LENS / SP



		3000K	H(m)	D(m)	E _{max} (lx)	
Ra97				10°		
Fixture Power	14W	1	0.18	17263		
Source Flux	1430lm	2	0.36	4316		
Fixture Flux	1101lm	3	0.54	1918		
Efficacy	82lm/W	4	0.72	1079		
TS1064	I _{max} =12072cd/klm	I _{max}	17263cd	5	0.89	691

Driver	Colour	3000K	4000K
EL.	○	1T6535EL	1T6536EL
EL.	●	1T6537EL	1T6538EL
DALI	○	1T6535DA	1T6536DA
DALI	●	1T6537DA	1T6538DA

LED / 12W / LENS / FL



		3000K	H(m)	D(m)	E _{max} (lx)	
Ra97				28°		
Fixture Power	14W	1	0.49	4536		
Source Flux	1430lm	2	0.99	1134		
Fixture Flux	1115lm	3	1.48	504		
Efficacy	83lm/W	4	1.98	284		
TS1065	I _{max} =3172cd/klm	I _{max}	4536cd	5	2.47	181

Driver	Colour	3000K	4000K
EL.	○	1T6539EL	1T6540EL
EL.	●	1T6541EL	1T6542EL
DALI	○	1T6539DA	1T6540DA
DALI	●	1T6541DA	1T6542DA

LED / 12W / REFLECTOR / MWFL



		3000K	H(m)	D(m)	E _{max} (lx)	
Ra97				48°		
Fixture Power	14W	1	0.90	1860		
Source Flux	1430lm	2	1.79	465		
Fixture Flux	1178lm	3	2.69	207		
Efficacy	87lm/W	4	3.59	116		
TS1066	I _{max} =1307cd/klm	I _{max}	1870cd	5	4.48	74

Driver	Colour	3000K	4000K
EL.	○	1T6543EL	1T6544EL
EL.	●	1T6545EL	1T6546EL
DALI	○	1T6543DA	1T6544DA
DALI	●	1T6545DA	1T6546DA

LED / 12W / REFLECTOR / WFL

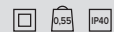

		3000K	H(m)	D(m)	E _{max} (lx)	
Ra97				58°		
Fixture Power	14W	1	1.11	1400		
Source Flux	1430lm	2	2.21	350		
Fixture Flux	1188lm	3	3.32	156		
Efficacy	88lm/W	4	4.43	88		
TS1067	I _{max} =1001cd/klm	I _{max}	1432cd	5	5.53	56

Driver	Colour	3000K	4000K
EL.	○	1T6547EL	1T6548EL
EL.	●	1T6549EL	1T6550EL
DALI	○	1T6547DA	1T6548DA
DALI	●	1T6549DA	1T6550DA

ZENO

Accessories

Filter

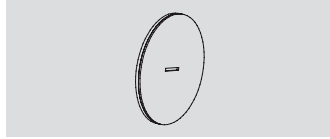

Code

1T6572

Blade of light filter.
Methacrylate holographic filter.
This makes the beam take on an oval shape and when combined with spotlights, the light blade appears more prominent.
To be completed with a dedicated holder ring.

Grid

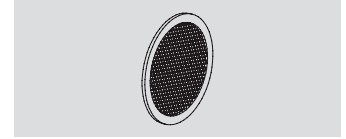

Code

1T6573

Anti-glare louver.
Black lacquered aluminium honeycomb structure.
To be completed with a dedicated holder ring.

Cut-off

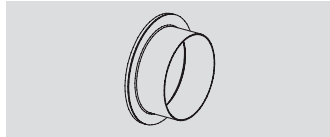

Code

1T6574

Black painted steel cut-off.
To be completed with a dedicated holder ring.

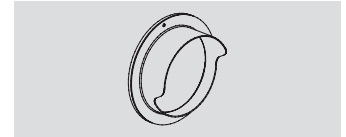

Code

1T6575

Black painted steel asymmetric cut-off.
To be completed with a dedicated holder ring.

Ray Shade

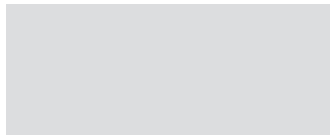

Code

1T6576

Adjustable barn doors flaps made of black painted steel.
To be completed with a dedicated holder ring.

Holder Ring

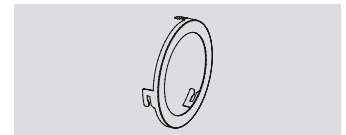

Colour



Code

1T6571

Black painted aluminium accessory holder ring.

Control systems

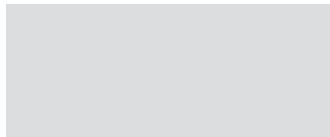

Code

1T5352

IP20 Extender for wireless control of DALI fixtures.
It generates a local DALI bus with the capacity to drive up to 64 fixtures.
Can control DALI fixtures in indoor applications.
It is also equipped with a relay that can control non-dimmable fixtures up to a maximum of 6A.



Magnani Rocca Foundation

Lighting design
Cavazzoni Associati

Photographer
Ivan Rossi

Country
Bologna - Italy

LABEL 230V

GENERAL INFO

Adjustable professional LED projector.

The optical unit can be adjusted from 0° a 90° on the vertical plane and 355° on the horizontal plane with the possibility to block the beam on the horizontal plane (friction blocking system on the vertical plane).
Ø60mm – Ø88mm

LED

Chip on board

From 2100lm to 3287lm

3000K – 4000K

Ra97

PRODUCT EFFICACY

Up to 82lm/W

OPTICS

SP – FL – MWFL

POWER SUPPLY

Electronic – DALI

Casambi control: the DALI version is fitted with special accessories.

MATERIAL

Die-cast painted aluminium body.

A coordinated range of projectors with track installation designed for applications in the retail, interior and hospitality industry. Available in two different sizes - LABEL 6 and LABEL 9 - with a retractable power supply in the track.

Every version has optics with reflectors for soft effects with broad tones. The set back LED lamp ensures perfect visual comfort.





Rinascimento Store Teddy Spa Group

Architect
WOMArchitettura
Arch. Teresa D'Alessandro
Arch. Caterina Pulcinella

Country
Cremona - Italy

LABEL



LABEL 6

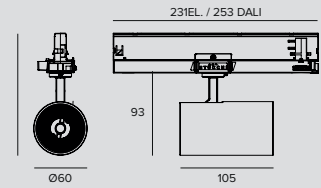

LED / 19W / REFLECTOR / SP



	3000K	H(m)	D(m)	Emax(lx)		
	Ra97		16°			
	Fixture Power	21W	1	0.28	12581	
	Source Flux	2100lm	2	0.55	3145	
	Fixture Flux	1542lm	3	0.83	1398	
	Efficacy	73lm/W	4	1.11	786	
TS1057	Imax=5991cd/klm	Imax	12581cd	5	1.39	503

Driver	Colour	3000K	4000K
EL.	○	1T6582EL	1T6583EL
EL.	●	1T6584EL	1T6585EL
EL.	●	1T6586EL	1T6587EL
DALI	○	1T6582DA	1T6583DA
DALI	●	1T6584DA	1T6585DA
DALI	●	1T6586DA	1T6587DA

LED / 19W / REFLECTOR / FL



	3000K	H(m)	D(m)	Emax(lx)		
	Ra97		31°			
	Fixture Power	21W	1	0.56	5165	
	Source Flux	2100lm	2	1.12	1291	
	Fixture Flux	1623lm	3	1.67	574	
	Efficacy	77lm/W	4	2.23	323	
TS1058	Imax=2459cd/klm	Imax	5165cd	5	2.79	207

Driver	Colour	3000K	4000K
EL.	○	1T6588EL	1T6589EL
EL.	●	1T6590EL	1T6591EL
EL.	●	1T6592EL	1T6593EL
DALI	○	1T6588DA	1T6589DA
DALI	●	1T6590DA	1T6591DA
DALI	●	1T6592DA	1T6593DA

LED / 19W / REFLECTOR / MWFL



	3000K	H(m)	D(m)	Emax(lx)		
	Ra97		48°			
	Fixture Power	21W	1	0.88	2879	
	Source Flux	2100lm	2	1.77	720	
	Fixture Flux	1609lm	3	2.65	320	
	Efficacy	76lm/W	4	3.53	180	
TS1059	Imax=1379cd/klm	Imax	2895cd	5	4.41	115

Driver	Colour	3000K	4000K
EL.	○	1T6594EL	1T6595EL
EL.	●	1T6596EL	1T6597EL
EL.	●	1T6598EL	1T6599EL
DALI	○	1T6594DA	1T6595DA
DALI	●	1T6596DA	1T6597DA
DALI	●	1T6598DA	1T6599DA



LABEL 9

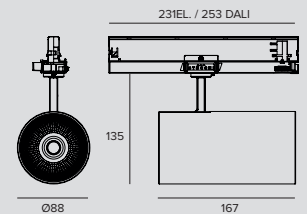

LED / 31W / REFLECTOR / SP



	3000K	H(m)	D(m)	Emax(lx)		
	Ra97		16°			
	Fixture Power	34W	1	0.29	17467	
	Source Flux	3207lm	2	0.57	4367	
	Fixture Flux	2322lm	3	0.86	1941	
	Efficacy	69lm/W	4	1.14	1092	
TS1060	Imax=5446cd/klm	Imax	17467cd	5	1.43	699

Driver	Colour	3000K	4000K
EL.	○	1T6600EL	1T6601EL
EL.	●	1T6602EL	1T6603EL
EL.	●	1T6604EL	1T6605EL

LED / 25W / REFLECTOR / SP

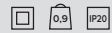

	3000K	H(m)	D(m)	E _{max} (lx)		
	Ra97		16°			
	Fixture Power	28W	1	0.29	15081	
	Source Flux	2769lm	2	0.57	3770	
	Fixture Flux	2005lm	3	0.86	1676	
	Efficacy	72lm/W	4	1.14	943	
TS1060	I _{max} =5446cd/klm	I _{max}	15081cd	5	1.43	603

Driver	Colour	3000K	4000K
DALI	○	1T6600DA	1T6601DA
DALI	●	1T6602DA	1T6603DA
DALI	●	1T6604DA	1T6605DA

LED / 31W / REFLECTOR / FL



	3000K	H(m)	D(m)	E _{max} (lx)		
	Ra97		29°			
	Fixture Power	34W	1	0.52	8572	
	Source Flux	3207lm	2	1.03	2143	
	Fixture Flux	2427lm	3	1.55	952	
	Efficacy	72lm/W	4	2.07	536	
TS1061	I _{max} =2673cd/klm	I _{max}	8572cd	5	2.58	343

Driver	Colour	3000K	4000K
EL.	○	1T6606EL	1T6607EL
EL.	●	1T6608EL	1T6609EL
EL.	●	1T6610EL	1T6611EL

LED / 25W / REFLECTOR / FL



	3000K	H(m)	D(m)	E _{max} (lx)		
	Ra97		29°			
	Fixture Power	28W	1	0.52	7401	
	Source Flux	2769lm	2	1.03	1850	
	Fixture Flux	2096lm	3	1.55	822	
	Efficacy	75lm/W	4	2.07	463	
TS1061	I _{max} =2673cd/klm	I _{max}	7401cd	5	2.58	296

Driver	Colour	3000K	4000K
DALI	○	1T6606DA	1T6607DA
DALI	●	1T6608DA	1T6609DA
DALI	●	1T6610DA	1T6611DA

LED / 31W / REFLECTOR / MWFL



	3000K	H(m)	D(m)	E _{max} (lx)		
	Ra97		46°			
	Fixture Power	34W	1	0.85	4471	
	Source Flux	3207lm	2	1.70	1118	
	Fixture Flux	2384lm	3	2.55	497	
	Efficacy	71lm/W	4	3.40	279	
TS1062	I _{max} =1426cd/klm	I _{max}	4572cd	5	4.25	179

Driver	Colour	3000K	4000K
EL.	○	1T6612EL	1T6613EL
EL.	●	1T6614EL	1T6615EL
EL.	●	1T6616EL	1T6617EL

LED / 25W / REFLECTOR / MWFL

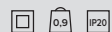

	3000K	H(m)	D(m)	E _{max} (lx)		
	Ra97		46°			
	Fixture Power	28W	1	0.85	3860	
	Source Flux	2769lm	2	1.70	965	
	Fixture Flux	2058lm	3	2.55	429	
	Efficacy	74lm/W	4	3.40	241	
TS1062	I _{max} =1426cd/klm	I _{max}	3947cd	5	4.25	154

Driver	Colour	3000K	4000K
DALI	○	1T6612DA	1T6613DA
DALI	●	1T6614DA	1T6615DA
DALI	●	1T6616DA	1T6617DA

Label 6 accessories

Screen

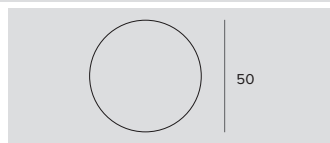

Ø Code
50 **1T6521**

Protective screen.

Grid

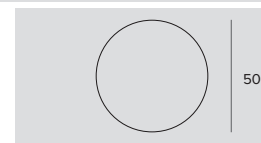

Ø Code
50 **1T4322**

Anti-glare louver.
Black painted metal honeycomb structure.
Complete with holographic diffusion filter.

LABEL

Filter

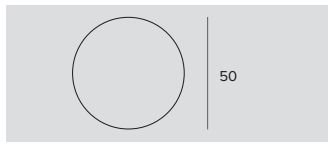

Filter	Ø	Code
Halogen +	50	1T6381
Vivid +	50	1T6383

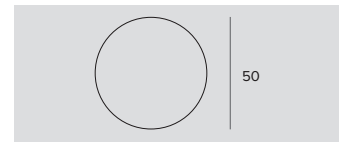

Filter	Ø	Code
Meat	50	1T6385
Fish	50	1T6387
Bread	50	1T6389
Vegetables	50	1T6391

Art filter.

Flat glass interference filter that can vary the colour parameters of the emission of the fixtures it is applied to.
To be used only with 3000K and Ra80 fixtures.

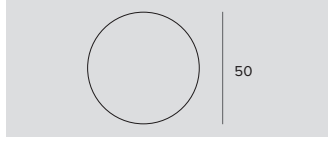

Filter	Ø	Code
Beauty	50	1T6393

Beauty filter.

Flat glass interference filter that can vary the colour parameters of the emission of the fixtures it is applied to.
To be used only with 3000K and Ra80 fixtures.

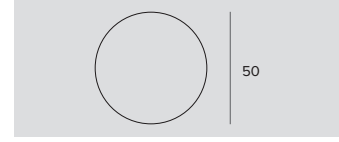

Ø	Code
50	1T4721

PMMA holographic filter with blade effect to ovalize the light beam; more evident when combined with spot and flood optics.

Control systems

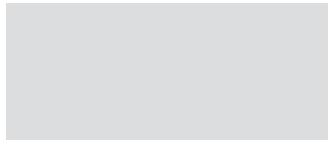

Code
1T5352

IP20 Extender for wireless control of DALI fixtures.
It generates a local DALI bus with the capacity to drive up to 64 fixtures.
Can control DALI fixtures in indoor applications.
It is also equipped with a relay that can control non-dimmable fixtures up to a maximum of 6A.

Label 9 accessories

Screen

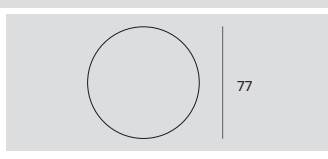

Ø	Code
77	1T6618

Protective screen.

Grid

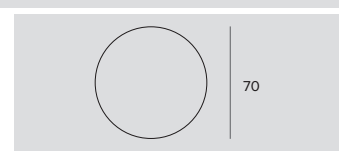

Ø	Code
70	1T1711

Anti-glare louver.
Black painted metal honeycomb structure.
To be completed with an additional holder ring for Cloud, Ray Mini, Store, Label 9 and Keplero Mini HE.

Filter

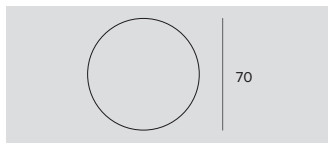

Filter	Ø	Code
Halogen +	70	1T6506
Vivid +	70	1T6507

Art filter.

Flat glass interference filter that can vary the colour parameters of the emission of the fixtures it is applied to.
To be used only with 3000K and Ra80 fixtures.
To be completed with an additional holder ring.

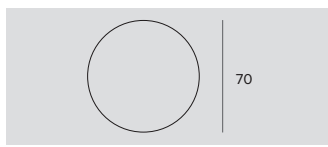

Filter	Ø	Code
Beauty	70	1T6512

Beauty filter.

Flat glass interference filter that can vary the colour parameters of the emission of the fixtures it is applied to.
To be used only with 3000K and Ra80 fixtures.
To be completed with an additional holder ring.

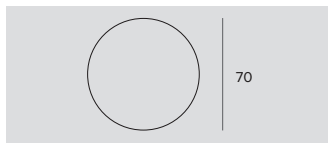
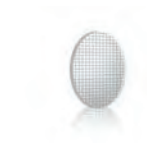

Ø	Code
70	1T1709

Flat glass wired refractive diffusive filter.

This softens the luminous effect.
To be completed with an additional holder ring.

Cut-off

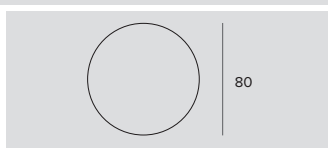

Ø	Code
80	1T3142

Cut-off Tube.

Allows for the beam to be focused while removing the fall-off component.
No for DBS version.

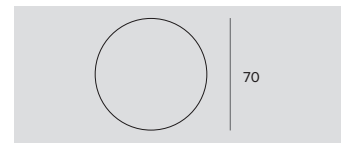

Filter	Ø	Code
Meat	70	1T6508
Fish	70	1T6509
Bread	70	1T6510
Vegetables	70	1T6511

Food filter.

Flat glass interference filter that can vary the colour parameters of the emission of the fixtures it is applied to.

To be completed with an additional holder ring.

1T6508

To be used only with 3000K and Ra80 fixtures.

1T6509

To be used only with 4000K and Ra80 fixtures.

1T6510

To be used only with 3000K and Ra80 fixtures.

1T6511

To be used only with 3000K and Ra80 fixtures.

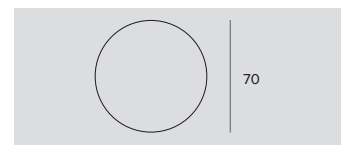

Ø	Code
70	1T1708

Flat striped glass blade light refractive filter.

This makes the beam take on an oval shape and when combined with spotlights, the light blade appears more prominent.

To be completed with an additional holder ring.

Holder Ring

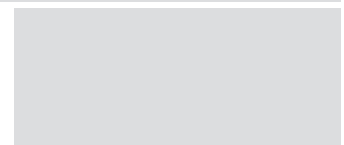

Code

1T3727

Transparent polycarbonate accessory holder ring.

Control systems

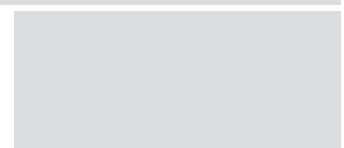

Code

1T5352

IP20 Extender for wireless control of DALI fixtures.

It generates a local DALI bus with the capacity to drive up to 64 fixtures.

Can control DALI fixtures in indoor applications.

It is also equipped with a relay that can control non-dimmable fixtures up to a maximum of 6A.

STORE

GENERAL INFO

Professional projector for LED sources.
 Optical chamber adjustable 0° - 90° vertically and 355° horizontally. Mechanical aiming lock in the horizontal plane and blocking equipped with a friction system in the vertical plane.
 STORE Ø93mm
 STORE MINI Ø75mm

LED

Chip on board
 From 1786lm to 4385lm
 3000K – 4000K
 Ra84 - Ra97

PRODUCT EFFICACY

Up to 119lm/W

OPTICS

SP – FL – MWFL – WFL

POWER SUPPLY

Electronic – DALI

MATERIAL

Optical chamber and power box in painted die-cast aluminium. Front ring for accessories in painted aluminium.

A range of projectors designed to meet the particular requirements of the Retail market where excellent performance, minimal design and controlled light are required. Available in a projector and recessed versions, both in two different sizes.

The projector version comes in two different sizes: a large version with a separate driver box and a Mini version with a driver hidden in the track.

		STORE	STORE MINI
		Ø 93mm	Ø 75mm
LED	Flux (lm)	2257- 4385	1786 - 2532
	Power	19W - 33W	11W - 18W

OPTICS

SP	Lenticular		•
	Reflector	•	
FL	Lenticular		•
	Reflector	•	
MWFL	Reflector	•	•
WFL	Reflector	•	•





Mc Laren Showroom

Country
Milan - Italy



Projector

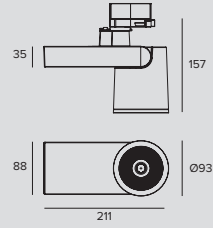

LED / 19W / REFLECTOR / SP / CRI84



		3000K	H(m)	D(m)	E _{max} (lx)
		Ra84			
		14°			
Fixture Power	22W	1	0.24	23022	
Source Flux	2935lm	2	0.48	5755	
Fixture Flux	2494lm	3	0.72	2558	
Efficacy	112lm/W	4	0.96	1439	
TS947	Imax=7844cd/klm	Imax	23022cd	5	1.20

Driver	Colour	3000K	4000K
EL.	○	1T5050EL	1T5052EL
EL.	●	1T5034EL	1T5036EL
DALI	○	1T5050DA	1T5052DA
DALI	●	1T5034DA	1T5036DA

LED / 19W / REFLECTOR / SP / CRI97



		3000K	H(m)	D(m)	E _{max} (lx)
		Ra97			
		14°			
Fixture Power	22W	1	0.24	17704	
Source Flux	2257lm	2	0.48	4426	
Fixture Flux	1918lm	3	0.72	1967	
Efficacy	86lm/W	4	0.96	1106	
TS947	Imax=7844cd/klm	Imax	17704cd	5	1.20

Driver	Colour	3000K	4000K
EL.	○	1T5051EL	1T5053EL
EL.	●	1T5035EL	1T5037EL
DALI	○	1T5051DA	1T5053DA
DALI	●	1T5035DA	1T5037DA

LED / 19W / REFLECTOR / FL / CRI84



		3000K	H(m)	D(m)	E _{max} (lx)
		Ra84			
		27°			
Fixture Power	22W	1	0.49	9061	
Source Flux	2935lm	2	0.97	2265	
Fixture Flux	2486lm	3	1.46	1007	
Efficacy	112lm/W	4	1.95	566	
TS948	Imax=3087cd/klm	Imax	9061cd	5	2.43

Driver	Colour	3000K	4000K
EL.	○	1T5054EL	1T5056EL
EL.	●	1T5038EL	1T5040EL
DALI	○	1T5054DA	1T5056DA
DALI	●	1T5038DA	1T5040DA

LED / 19W / REFLECTOR / FL / CRI97



		3000K	H(m)	D(m)	E _{max} (lx)
		Ra97			
		27°			
Fixture Power	22W	1	0.49	6968	
Source Flux	2257lm	2	0.97	1742	
Fixture Flux	1912lm	3	1.46	774	
Efficacy	86lm/W	4	1.95	435	
TS948	Imax=3087cd/klm	Imax	6968cd	5	2.43

Driver	Colour	3000K	4000K
EL.	○	1T5055EL	1T5057EL
EL.	●	1T5039EL	1T5041EL
DALI	○	1T5055DA	1T5057DA
DALI	●	1T5039DA	1T5041DA

LED / 19W / REFLECTOR / MWFL / CRI84



		3000K	H(m)	D(m)	E _{max} (lx)
		Ra84			
		45°			
Fixture Power	22W	1	0.82	4770	
Source Flux	2935lm	2	1.64	1193	
Fixture Flux	2550lm	3	2.46	530	
Efficacy	115lm/W	4	3.28	298	
TS949	Imax=1655cd/klm	Imax	4856cd	5	4.10

Driver	Colour	3000K	4000K
EL.	○	1T5058EL	1T5060EL
EL.	●	1T5042EL	1T5044EL
DALI	○	1T5058DA	1T5060DA
DALI	●	1T5042DA	1T5044DA

LED / 19W / REFLECTOR / MWFL / CRI97



		3000K	H(m)	D(m)	E _{max} (lx)
		Ra97		45°	
Fixture Power	22W	1	0.82	3668	
Source Flux	2257lm	2	1.64	917	
Fixture Flux	1961lm	3	2.46	408	
Efficacy	88lm/W	4	3.28	229	
TS949	I _{max} =1655cd/klm	I _{max}	3734cd	5	4.10
				147	

Driver	Colour	3000K	4000K
EL.	○	1T5059EL	1T5061EL
EL.	●	1T5043EL	1T5045EL
DALI	○	1T5059DA	1T5061DA
DALI	●	1T5043DA	1T5045DA

LED / 19W / REFLECTOR / WFL / CRI84



		3000K	H(m)	D(m)	E _{max} (lx)
		Ra84		59°	
Fixture Power	22W	1	1.13	3318	
Source Flux	2935lm	2	2.26	830	
Fixture Flux	2585lm	3	3.39	369	
Efficacy	116lm/W	4	4.51	207	
TS950	I _{max} =1141cd/klm	I _{max}	3350cd	5	5.64
				133	

Driver	Colour	3000K	4000K
EL.	○	1T5062EL	1T5064EL
EL.	●	1T5046EL	1T5048EL
DALI	○	1T5062DA	1T5064DA
DALI	●	1T5046DA	1T5048DA

LED / 19W / REFLECTOR / WFL / CRI97



		3000K	H(m)	D(m)	E _{max} (lx)
		Ra97		59°	
Fixture Power	22W	1	1.13	2552	
Source Flux	2257lm	2	2.26	638	
Fixture Flux	1988lm	3	3.39	284	
Efficacy	90lm/W	4	4.51	159	
TS950	I _{max} =1141cd/klm	I _{max}	2576cd	5	5.64
				102	

Driver	Colour	3000K	4000K
EL.	○	1T5063EL	1T5065EL
EL.	●	1T5047EL	1T5049EL
DALI	○	1T5063DA	1T5065DA
DALI	●	1T5047DA	1T5049DA

LED / 33W / REFLECTOR / SP / CRI84



		3000K	H(m)	D(m)	E _{max} (lx)
		Ra84		14°	
Fixture Power	36W	1	0.24	33552	
Source Flux	4277lm	2	0.48	8388	
Fixture Flux	3635lm	3	0.72	3728	
Efficacy	102lm/W	4	0.96	2097	
TS951	I _{max} =7845cd/klm	I _{max}	33552cd	5	1.20
				1342	

Driver	Colour	3000K	4000K
EL.	○	1T5082EL	1T5084EL
EL.	●	1T5066EL	1T5068EL
DALI	○	1T5082DA	1T5084DA
DALI	●	1T5066DA	1T5068DA

LED / 33W / REFLECTOR / SP / CRI97



		3000K	H(m)	D(m)	E _{max} (lx)
		Ra97		14°	
Fixture Power	36W	1	0.24	25809	
Source Flux	3290lm	2	0.48	6452	
Fixture Flux	2796lm	3	0.72	2868	
Efficacy	78lm/W	4	0.96	1613	
TS951	I _{max} =7845cd/klm	I _{max}	25809cd	5	1.20
				1032	

Driver	Colour	3000K	4000K
EL.	○	1T5083EL	1T5085EL
EL.	●	1T5067EL	1T5069EL
DALI	○	1T5083DA	1T5085DA
DALI	●	1T5067DA	1T5069DA

LED / 33W / REFLECTOR / FL / CRI84



		3000K	H(m)	D(m)	E _{max} (lx)
		Ra84		27°	
Fixture Power	36W	1	0.49	13204	
Source Flux	4277lm	2	0.97	3301	
Fixture Flux	3622lm	3	1.46	1467	
Efficacy	101lm/W	4	1.95	825	
TS952	I _{max} =3087cd/klm	I _{max}	13204cd	5	2.43
				528	

Driver	Colour	3000K	4000K
EL.	○	1T5086EL	1T5088EL
EL.	●	1T5070EL	1T5072EL
DALI	○	1T5086DA	1T5088DA
DALI	●	1T5070DA	1T5072DA

STORE

LED / 33W / REFLECTOR / FL / CRI97



		3000K	H(m)	D(m)	Emax(lx)
Ra97				27°	
Fixture Power	36W	1	0.49	10157	
Source Flux	3290lm	2	0.97	2539	
Fixture Flux	2786lm	3	1.46	1129	
Efficacy	78lm/W	4	1.95	635	
TS952	Imax=3087cd/klm	Imax	10157cd	5	2.43
					406

Driver	Colour	3000K	4000K
EL.	○	1T5087EL	1T5089EL
EL.	●	1T5071EL	1T5073EL
DALI	○	1T5087DA	1T5089DA
DALI	●	1T5071DA	1T5073DA

LED / 33W / REFLECTOR / MWFL / CRI84



		3000K	H(m)	D(m)	Emax(lx)
Ra84				45°	
Fixture Power	36W	1	0.82	6951	
Source Flux	4277lm	2	1.64	1738	
Fixture Flux	3716lm	3	2.46	772	
Efficacy	104lm/W	4	3.28	434	
TS953	Imax=1655cd/klm	Imax	7076cd	5	4.10
					278

Driver	Colour	3000K	4000K
EL.	○	1T5090EL	1T5092EL
EL.	●	1T5074EL	1T5076EL
DALI	○	1T5090DA	1T5092DA
DALI	●	1T5074DA	1T5076DA

LED / 33W / REFLECTOR / MWFL / CRI97



		3000K	H(m)	D(m)	Emax(lx)
Ra97				45°	
Fixture Power	36W	1	0.82	5347	
Source Flux	3290lm	2	1.64	1337	
Fixture Flux	2859lm	3	2.46	594	
Efficacy	80lm/W	4	3.28	334	
TS953	Imax=1655cd/klm	Imax	5443cd	5	4.10
					214

Driver	Colour	3000K	4000K
EL.	○	1T5091EL	1T5093EL
EL.	●	1T5075EL	1T5077EL
DALI	○	1T5091DA	1T5093DA
DALI	●	1T5075DA	1T5077DA

LED / 33W / REFLECTOR / WFL / CRI84



		3000K	H(m)	D(m)	Emax(lx)
Ra84				59°	
Fixture Power	36W	1	1.13	4836	
Source Flux	4277lm	2	2.26	1209	
Fixture Flux	3768lm	3	3.39	537	
Efficacy	106lm/W	4	4.51	302	
TS954	Imax=1142cd/klm	Imax	4882cd	5	5.64
					193

Driver	Colour	3000K	4000K
EL.	○	1T5094EL	1T5096EL
EL.	●	1T5078EL	1T5080EL
DALI	○	1T5094DA	1T5096DA
DALI	●	1T5078DA	1T5080DA

LED / 33W / REFLECTOR / WFL / CRI97



		3000K	H(m)	D(m)	Emax(lx)
Ra97				59°	
Fixture Power	36W	1	1.13	3720	
Source Flux	3290lm	2	2.26	930	
Fixture Flux	2898lm	3	3.39	413	
Efficacy	81lm/W	4	4.51	233	
TS954	Imax=1142cd/klm	Imax	3756cd	5	5.64
					149

Driver	Colour	3000K	4000K
EL.	○	1T5095EL	1T5097EL
EL.	●	1T5079EL	1T5081EL
DALI	○	1T5095DA	1T5097DA
DALI	●	1T5079DA	1T5081DA

Accessories

Filter

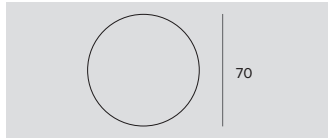

Filter	Ø	Code
Red	70	1T1712
Green	70	1T1713
Blue	70	1T1714
Yellow	70	1T1715
Magenta	70	1T1716

Flat glass interference chromatic filter.
To be completed with an additional holder ring.

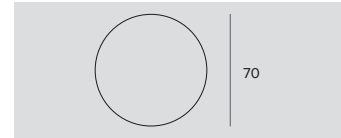

Ø	Code
70	1T1708

Flat striped glass blade light refractive filter.
This makes the beam take on an oval shape and when combined with spotlights, the light blade appears more prominent.
To be completed with an additional holder ring.

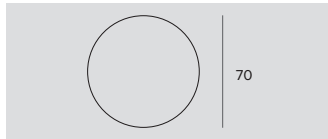

Ø	Code
70	1T1709

Flat glass wired refractive diffusive filter.
This softens the luminous effect.
To be completed with an additional holder ring.

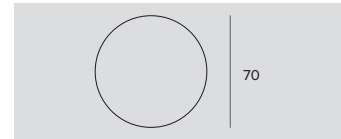

Filter	Ø	Code
Halogen +	70	1T6506
Vivid +	70	1T6507

Art filter.
Flat glass interference filter that can vary the colour parameters of the emission of the fixtures it is applied to.
To be used only with 3000K and Ra80 fixtures.
To be completed with an additional holder ring.

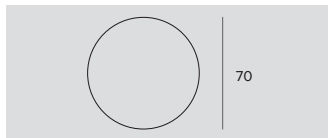

Filter	Ø	Code
Meat	70	1T6508
Fish	70	1T6509
Bread	70	1T6510
Vegetables	70	1T6511

Food filter.
Flat glass interference filter that can vary the colour parameters of the emission of the fixtures it is applied to.
To be completed with an additional holder ring.

To be used only with 3000K and Ra80 fixtures.
1T6509
To be used only with 4000K and Ra80 fixtures.
1T6510
To be used only with 3000K and Ra80 fixtures.
1T6511
To be used only with 3000K and Ra80 fixtures.

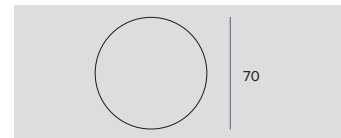



Filter	Ø	Code
Beauty	70	1T6512

Beauty filter.
Flat glass interference filter that can vary the colour parameters of the emission of the fixtures it is applied to.
To be used only with 3000K and Ra80 fixtures.
To be completed with an additional holder ring.

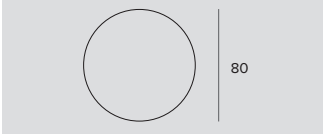
STORE

Screen	
	
	80
Ø	Code
80	1T6522



Protective screen.

Zoom	
	
	80
Ø	Code
80	1T3432

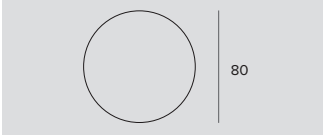

Zoom.
Optical system consists of an optical glass flat convex lens, an anodized aluminium specular reflector and a diffusive holographic filter.
To be used after removing the existing optic.
It makes it possible to obtain a variable beam from 15° to 60°.
It can not be used with NSP and hybrid optics; no for DBS version.

Screen	
	
	80
Ø	Code
80	1T3143

Black painted anodized diffusive aluminium asymmetric screen.
Complete with blade light filter.
Ideal for a Wall Washer effect.
To be combined with spot and flood optics.

Grid	
	
	70
Ø	Code
70	1T1711

Anti-glare louver.
Black painted metal honeycomb structure.
To be completed with an additional holder ring.

Cut-off	
	
	80
Ø	Code
80	1T3142

Cut-off Tube.
Allows for the beam to be focused while removing the fall-off component.
No for DBS version.

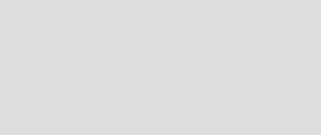
Holder Ring	
	
	80
Ø	Code
80	1T3727

Transparent polycarbonate accessory holder ring.

Adapter



Ø100
H32

Ø	H	Driver	Colour	Code
100	32	EL.	○	1T2221
100	32	EL.	●	1T2220
100	32	EL.	●	1T2219

Ceiling mounting adapter for electrified track type projectors.

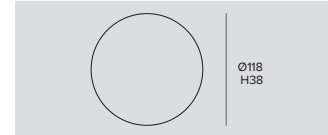

Ø118
H38

Ø	H	Driver	Colour	Code
118	38	DALI	○	9000/BPU-D-W
118	38	DALI	●	9000/BPU-D-B
118	38	DALI	●	9000/BPU-D-G

Ceiling mounting adapter for electrified track type projectors.

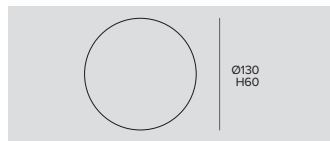

Ø130
H60

Cutout hole	Ø	H	Driver	Colour	Code
Ø105/125	130	60	EL.	○	1T2223
Ø105/125	130	60	EL.	●	1T2222
Ø105/125	130	60	EL.	●	1T2224

Recessed mounting adapter for electrified track type projectors.

1T2222 - To be completed with 1T2220.

1T2223 - To be completed with 1T2221.

1T2224 - To be completed with 1T2219.

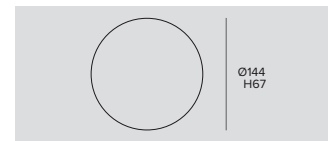

Ø144
H67

Cutout hole	Ø	H	Driver	Colour	Code
Ø125/130	144	67	DALI	○	9000/BRU-W
Ø125/130	144	67	DALI	●	9000/BRU-B
Ø125/130	144	67	DALI	●	9000/BRU-G

Recessed mounting adapter for electrified track type projectors.

9000/BRU-G - To be completed with 9000/BPU-D-G.

9000/BRU-W - To be completed with 9000/BPU-D-W.

9000/BRU-B - To be completed with 9000/BPU-D-B.



Mini Projector

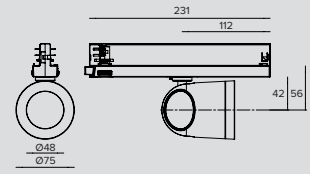

LED / 11W / LENS / SP □ 0.4 IP20

		3000K	H(m)	D(m)	E _{max} (lx)	
		Ra84		15°		
Fixture Power	15W	1	0.27	16914		
Source Flux	1786lm	2	0.53	4229		
Fixture Flux	1336lm	3	0.80	1879		
Efficacy	90lm/W	4	1.07	1057		
TS966	I _{max} =9470cd/klm	I _{max}	16914cd	5	1.33	677

Driver	Colour	3000K	4000K
EL.	○	1T5016EL	1T5017EL
EL.	●	1T5010EL	1T5011EL

LED / 12W / LENS / FL □ 0.4 IP20

		3000K	H(m)	D(m)	E _{max} (lx)	
		Ra84		30°		
Fixture Power	14W	1	0.54	4825		
Source Flux	1837lm	2	1.09	1206		
Fixture Flux	1315lm	3	1.63	536		
Efficacy	97lm/W	4	2.17	302		
TS967	I _{max} =2627cd/klm	I _{max}	4825cd	5	2.72	193

Driver	Colour	3000K	4000K
EL.	○	1T5018EL	1T5019EL
EL.	●	1T5012EL	1T5013EL

LED / 12W / REFLECTOR / MWFL □ 0.4 IP20

		3000K	H(m)	D(m)	E _{max} (lx)	
		Ra84		48°		
Fixture Power	14W	1	0.90	2476		
Source Flux	1837lm	2	1.80	619		
Fixture Flux	1520lm	3	2.69	275		
Efficacy	113lm/W	4	3.59	155		
TS968	I _{max} =1372cd/klm	I _{max}	2520cd	5	4.49	99

Driver	Colour	3000K	4000K
EL.	○	1T5020EL	1T5021EL
EL.	●	1T5014EL	1T5015EL

LED / 18W / LENS / SP □ 0.4 IP20

		3000K	H(m)	D(m)	E _{max} (lx)	
		Ra84		24°		
Fixture Power	20W	1	0.43	8803		
Source Flux	2466lm	2	0.87	2201		
Fixture Flux	1800lm	3	1.30	978		
Efficacy	89lm/W	4	1.73	550		
TS969	I _{max} =3570cd/klm	I _{max}	8803cd	5	2.17	352

Driver	Colour	3000K	4000K
EL.	○	1T5028EL	1T5029EL
EL.	●	1T5022EL	1T5023EL

LED / 18W / REFLECTOR / MWFL □ 0.4 IP20

		3000K	H(m)	D(m)	E _{max} (lx)	
		Ra84		48°		
Fixture Power	20W	1	0.90	3323		
Source Flux	2466lm	2	1.80	831		
Fixture Flux	2041lm	3	2.69	369		
Efficacy	101lm/W	4	3.59	208		
TS970	I _{max} =1372cd/klm	I _{max}	3383cd	5	4.49	133

Driver	Colour	3000K	4000K
EL.	○	1T5030EL	1T5031EL
EL.	●	1T5024EL	1T5025EL

LED / 18W / REFLECTOR / WFL



		3000K	H(m)	D(m)	E _{max} (lx)	
Ra84				60°		
Fixture Power	20W	1	1.16	2406		
Source Flux	2466lm	2	2.32	601		
Fixture Flux	1979lm	3	3.47	267		
Efficacy	98lm/W	4	4.63	150		
TS971	I _{max} =976cd/klm	I _{max}	2407cd	5	5.79	96

Driver	Colour	3000K	4000K
EL.	○	1T5032EL	1T5033EL
EL.	●	1T5026EL	1T5027EL



Mini Projector

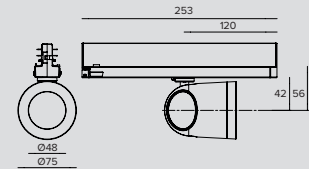

LED / 11W / LENS / SP



		3000K	H(m)	D(m)	E _{max} (lx)	
Ra84				15°		
Fixture Power	15W	1	0.27	16914		
Source Flux	1786lm	2	0.53	4229		
Fixture Flux	1336lm	3	0.80	1879		
Efficacy	90lm/W	4	1.07	1057		
TS966	I _{max} =9470cd/klm	I _{max}	16914cd	5	1.33	677

Driver	Colour	3000K	4000K
DALI	○	1T5016DA	1T5017DA
DALI	●	1T5010DA	1T5011DA

LED / 12W / LENS / FL



		3000K	H(m)	D(m)	E _{max} (lx)	
Ra84				30°		
Fixture Power	14W	1	0.54	4825		
Source Flux	1837lm	2	1.09	1206		
Fixture Flux	1315lm	3	1.63	536		
Efficacy	97lm/W	4	2.17	302		
TS967	I _{max} =2627cd/klm	I _{max}	4825cd	5	2.72	193

Driver	Colour	3000K	4000K
DALI	○	1T5018DA	1T5019DA
DALI	●	1T5012DA	1T5013DA

LED / 12W / REFLECTOR / MWFL



		3000K	H(m)	D(m)	E _{max} (lx)	
Ra84				48°		
Fixture Power	14W	1	0.90	2476		
Source Flux	1837lm	2	1.80	619		
Fixture Flux	1520lm	3	2.69	275		
Efficacy	113lm/W	4	3.59	155		
TS968	I _{max} =1372cd/klm	I _{max}	2520cd	5	4.49	99

Driver	Colour	3000K	4000K
DALI	○	1T5020DA	1T5021DA
DALI	●	1T5014DA	1T5015DA

LED / 18W / LENS / SP



		3000K	H(m)	D(m)	E _{max} (lx)	
Ra84				24°		
Fixture Power	20W	1	0.43	8803		
Source Flux	2466lm	2	0.87	2201		
Fixture Flux	1800lm	3	1.30	978		
Efficacy	89lm/W	4	1.73	550		
TS969	I _{max} =3570cd/klm	I _{max}	8803cd	5	2.17	352

Driver	Colour	3000K	4000K
DALI	○	1T5028DA	1T5029DA
DALI	●	1T5022DA	1T5023DA

STORE

LED / 18W / REFLECTOR / MWFL



	3000K	H(m)	D(m)	Emax(lx)		
	Ra84		48°			
	Fixture Power	20W	1	0.90	3323	
	Source Flux	2466lm	2	1.80	831	
	Fixture Flux	2041lm	3	2.69	369	
	Efficacy	101lm/W	4	3.59	208	
TS970	Imax=1372cd/klm	Imax	3383cd	5	4.49	133

Driver	Colour	3000K	4000K
DALI	○	1T5030DA	1T5031DA
DALI	●	1T5024DA	1T5025DA

LED / 18W / REFLECTOR / WFL



	3000K	H(m)	D(m)	Emax(lx)		
	Ra84		60°			
	Fixture Power	20W	1	1.16	2406	
	Source Flux	2466lm	2	2.32	601	
	Fixture Flux	1979lm	3	3.47	267	
	Efficacy	98lm/W	4	4.63	150	
TS971	Imax=976cd/klm	Imax	2407cd	5	5.79	96

Driver	Colour	3000K	4000K
DALI	○	1T5032DA	1T5033DA
DALI	●	1T5026DA	1T5027DA

Accessories

Filter

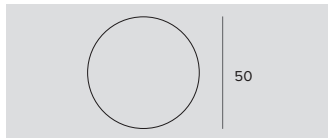

Filter	Ø	Code
Red	50	49881
Green	50	49882
Blue	50	49886
Yellow	50	49887
Magenta	50	49959

Flat glass interference chromatic filter.

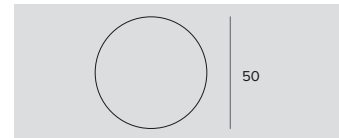

Filter	Ø	Code
	50	1T4721

PMMA holographic filter with blade effect to ovalize the light beam; more evident when combined with spot and flood optics.

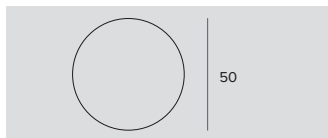

Filter	Ø	Code
Halogen +	50	1T6381
Vivid +	50	1T6383

Art filter.

Flat glass interference filter that can vary the colour parameters of the emission of the fixtures it is applied to.
To be used only with 3000K and Ra80 fixtures.

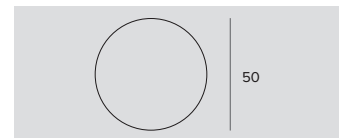

Filter	Ø	Code
Meat	50	1T6385
Fish	50	1T6387
Bread	50	1T6389
Vegetables	50	1T6391

Food filter.

Flat glass interference filter that can vary the colour parameters of the emission of the fixtures it is applied to.

1T6385

To be used only with 3000K and Ra80 fixtures.

1T6387

To be used only with 4000K and Ra80 fixtures.

1T6389

To be used only with 3000K and Ra80 fixtures.

1T6391

To be used only with 3000K and Ra80 fixtures.

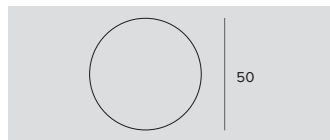

Filter	Ø	Code
Beauty	50	1T6393

Beauty filter.
Flat glass interference filter that can vary the colour parameters of the emission of the fixtures it is applied to.
To be used only with 3000K and Ra80 fixtures.

Screen

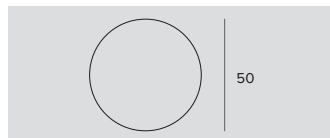

Ø	Code
50	1T4325

Black painted anodized diffusive aluminium asymmetric screen.
Complete with blade light filter.
Ideal for a Wall Washer effect.
To be combined with spot and flood optics.

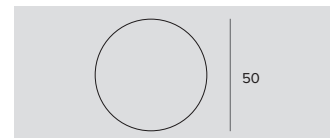

Ø	Code
50	1T6521

Protective screen.

Grid

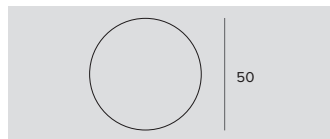

Ø	Code
50	1T4322

Anti-glare louver.
Black painted metal honeycomb structure.
Complete with holographic diffusion filter.

Zoom

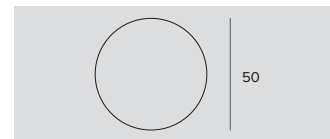

Ø	Code
50	1T4324

Zoom.
Optical system consists of an optical glass flat convex lens, an anodized aluminium specular reflector and a diffusive holographic filter.
To be used after removing the existing optic.
It can not be used with a narrow spot optic.
It makes it possible to obtain a variable beam from 15° to 60°.

LEDÒ

GENERAL INFO

Professional adjustable LED projector.
The body can be adjusted from 0° to 90° on a vertical plane and by 355° on a horizontal plane with double blocking equipped with a friction system.
LEDÒ L, 178mm
LEDÒ TUNABLE and DBS L, 213mm

LED

STANDARD E DBS: Chip on board
From 2524lm to 3155lm
3000K – 4000K
Ra97
TUNABLE: Chip on board
From 1960lm to 2290lm
From 2700K to 5700K
Ra90

PRODUCT EFFICACY

Up to 92lm/W

OPTICS

SP – FL – MWFL – WFL
DBS - Digital beam opening control

POWER SUPPLY

Electronic – DALI
Control: Dimmer on board – Casambi on board

MATERIAL

Painted die-cast aluminium body (L=178 mm) or extruded painted aluminium body (L=213 mm). Front interchangeable optic camera in black polycarbonate for the standard version and in the same colour of the body for the LOF version, back ring with radial grid for heat dissipation.

Track projectors designed for museum lighting given the precise beam modelling, the high colour quality of the light and excellent colour rendering. Available with a fixed optic with a DBS system to modulate the beam on the object to be lit up to 50°.

The Tunable version on the other hand allows to vary the colour temperature from 2700K to 5700K.

The different versions are available with an electronic driver, a dimmable on board driver or can be controlled with a smartphone using the Casambi app to manage the luminous intensity of every single fixture.

The electronic, DALI and DBS versions have an integrated driver. The Tunable version has a separate driver.





Saint Germain des Prés

Lighting Design
Armand Zadkian

Photographer
Hugo Hebrard

Country
Paris - France





L. 178mm

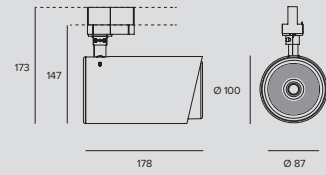

LED / 25W / HYBRID / SP / CRI97 ± 1 IP20

		3000K	H(m)	D(m)	E _{max} (lx)
Ra97				13°	
Fixture Power	27W	1	0.23	23221	
Source Flux	2524lm	2	0.46	5805	
Fixture Flux	1637lm	3	0.69	2580	
Efficacy	61lm/W	4	0.92	1451	
TS928	Imax=9200cd/klm Imax	5	1.14	929	

Driver	Colour	3000K	4000K
EL.	○	1T4882	1T4883
EL.	●	1T4886	1T4887
EL.	●	1T4878	1T4879
DIMM ON BOARD	○	1T4890	
DIMM ON BOARD	○	1T4892	
DIMM ON BOARD	●	1T4894	
DALI	○	1T4896	
DALI	○	1T4898	
DALI	●	1T4900	

LED / 25W / HYBRID / FL / CRI97 ± 1 IP20

		3000K	H(m)	D(m)	E _{max} (lx)
Ra97				33°	
Fixture Power	27W	1	0.58	5627	
Source Flux	2524lm	2	1.17	1407	
Fixture Flux	1541lm	3	1.75	625	
Efficacy	57lm/W	4	2.33	352	
TS929	Imax=2230cd/klm Imax	5	2.92	225	

Driver	Colour	3000K	4000K
EL.	○	1T4884	1T4885
EL.	●	1T4888	1T4889
EL.	●	1T4880	1T4881
DIMM ON BOARD	○	1T4891	
DIMM ON BOARD	○	1T4893	
DIMM ON BOARD	●	1T4895	
DALI	○	1T4897	
DALI	○	1T4899	
DALI	●	1T4901	

LED / 25W / REFLECTOR / MWFL / CRI97 ± 1 IP20

		3000K	H(m)	D(m)	E _{max} (lx)
Ra97				45°	
Fixture Power	27W	1	0.82	4412	
Source Flux	2714lm	2	1.64	1103	
Fixture Flux	2358lm	3	2.46	490	
Efficacy	87lm/W	4	3.28	276	
TS930	Imax=1655cd/klm Imax	5	4.10	176	

Driver	Colour	3000K	4000K
EL.	○	1T3491	1T3492
EL.	●	1T3499	1T3500
EL.	●	1T3483	1T3484
DIMM ON BOARD	○	1T4369	
DIMM ON BOARD	○	1T4373	
DIMM ON BOARD	●	1T4377	
DALI	○	1T4381	
DALI	○	1T4385	
DALI	●	1T4389	

LED / 25W / REFLECTOR / WFL / CRI97 ± 1 IP20

		3000K	H(m)	D(m)	E _{max} (lx)
Ra97				59°	
Fixture Power	27W	1	1.13	3071	
Source Flux	2714lm	2	2.26	768	
Fixture Flux	2392lm	3	3.39	341	
Efficacy	89lm/W	4	4.51	192	
TS931	Imax=1142cd/klm Imax	5	5.64	123	

Driver	Colour	3000K	4000K
EL.	○	1T3493	1T3494
EL.	●	1T3501	1T3502
EL.	●	1T3485	1T3486
DIMM ON BOARD	○	1T4370	
DIMM ON BOARD	○	1T4374	
DIMM ON BOARD	●	1T4378	
DALI	○	1T4382	
DALI	○	1T4386	
DALI	●	1T4390	



CASAMBI L. 178mm

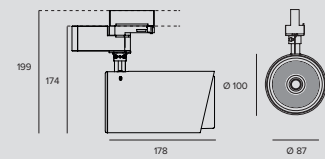

LED / 25W / HYBRID / SP / CRI97						
		3000K	H(m)	D(m)	Emax(lx)	
		Ra97		13°		
Fixture Power	27W	1	0.23	23221		
Source Flux	2524lm	2	0.46	5805		
Fixture Flux	1637lm	3	0.69	2580		
Efficacy	61lm/W	4	0.92	1451		
TS928	Imax=9200cd/klm	Imax	23221cd	5	1.14	929

Driver	Colour	3000K	4000K
CASAMBI		1T4896CA	
CASAMBI		1T4898CA	
CASAMBI		1T4900CA	

LED / 25W / HYBRID / FL / CRI97						
		3000K	H(m)	D(m)	Emax(lx)	
		Ra97		33°		
Fixture Power	27W	1	0.58	5627		
Source Flux	2524lm	2	1.17	1407		
Fixture Flux	1541lm	3	1.75	625		
Efficacy	57lm/W	4	2.33	352		
TS929	Imax=2230cd/klm	Imax	5627cd	5	2.92	225

Driver	Colour	3000K	4000K
CASAMBI		1T4897CA	
CASAMBI		1T4899CA	
CASAMBI		1T4901CA	

LED / 25W / REFLECTOR / MWFL / CRI97						
		3000K	H(m)	D(m)	Emax(lx)	
		Ra97		45°		
Fixture Power	27W	1	0.82	4412		
Source Flux	2714lm	2	1.64	1103		
Fixture Flux	2358lm	3	2.46	490		
Efficacy	87lm/W	4	3.28	276		
TS930	Imax=1655cd/klm	Imax	4491cd	5	4.10	176

Driver	Colour	3000K	4000K
CASAMBI		1T4381CA	
CASAMBI		1T4385CA	
CASAMBI		1T4389CA	

LED / 25W / REFLECTOR / WFL / CRI97						
		3000K	H(m)	D(m)	Emax(lx)	
		Ra97		59°		
Fixture Power	27W	1	1.13	3071		
Source Flux	2714lm	2	2.26	768		
Fixture Flux	2392lm	3	3.39	341		
Efficacy	89lm/W	4	4.51	192		
TS931	Imax=1142cd/klm	Imax	3100cd	5	5.64	123

Driver	Colour	3000K	4000K
CASAMBI		1T4382CA	
CASAMBI		1T4386CA	
CASAMBI		1T4390CA	



DBS L. 213mm

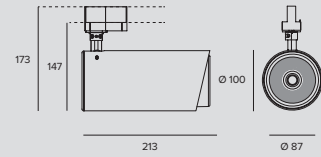

LED / 25W / DBS / CRI97

		3000K	H(m)	D(m)	E _{max} (lx)	
Ra97				16°		
Fixture Power	27W	1	0.28	11780		
Source Flux	2524lm	2	0.56	2945		
Fixture Flux	1206lm	3	0.84	1309		
Efficacy	45lm/W	4	1.12	736		
TS1114	I _{max} =4667cd/klm	I _{max}	11780cd	5	1.40	471

		3000K	H(m)	D(m)	E _{max} (lx)	
Ra97				25°		
Fixture Power	27W	1	0.45	4530		
Source Flux	2524lm	2	0.89	1132		
Fixture Flux	1166lm	3	1.34	503		
Efficacy	43lm/W	4	1.79	283		
TS1115	I _{max} =1795cd/klm	I _{max}	4530cd	5	2.24	181

		3000K	H(m)	D(m)	E _{max} (lx)	
Ra97				42°		
Fixture Power	27W	1	0.78	1566		
Source Flux	2524lm	2	1.55	392		
Fixture Flux	1075lm	3	2.33	174		
Efficacy	40lm/W	4	3.11	98		
TS1117	I _{max} =620cd/klm	I _{max}	1566cd	5	3.88	63

Driver	Colour	3000K	4000K
CASAMBI	○	1T6955CA	1T6959CA
CASAMBI	●	1T6956CA	1T6960CA
CASAMBI	●	1T6957CA	1T6961CA
CASAMBI	●	1T6958CA	1T6962CA

		3000K	H(m)	D(m)	E _{max} (lx)	
Ra97				34°		
Fixture Power	27W	1	0.61	2485		
Source Flux	2524lm	2	1.23	621		
Fixture Flux	1133lm	3	1.84	276		
Efficacy	42lm/W	4	2.45	155		
TS1116	I _{max} =984cd/klm	I _{max}	2485cd	5	3.07	99

LED / 31W / DBS / CRI97

		3000K	H(m)	D(m)	E _{max} (lx)	
Ra97				16°		
Fixture Power	34W	1	0.28	14361		
Source Flux	3077lm	2	0.56	3590		
Fixture Flux	1471lm	3	0.84	1596		
Efficacy	43lm/W	4	1.12	898		
TS1114	I _{max} =4667cd/klm	I _{max}	14361cd	5	1.40	574

		3000K	H(m)	D(m)	E _{max} (lx)	
Ra97				25°		
Fixture Power	34W	1	0.45	5522		
Source Flux	3077lm	2	0.89	1381		
Fixture Flux	1422lm	3	1.34	614		
Efficacy	41lm/W	4	1.79	345		
TS1115	I _{max} =1795cd/klm	I _{max}	5522cd	5	2.24	221

		3000K	H(m)	D(m)	E _{max} (lx)	
Ra97				42°		
Fixture Power	34W	1	0.78	1909		
Source Flux	3077lm	2	1.55	477		
Fixture Flux	1311lm	3	2.33	212		
Efficacy	38lm/W	4	3.11	119		
TS1117	I _{max} =620cd/klm	I _{max}	1909cd	5	3.88	76

Driver	Colour	3000K	4000K
CASAMBI	○	1T6963CA	1T6967CA
CASAMBI	●	1T6964CA	1T6968CA
CASAMBI	●	1T6965CA	1T6969CA
CASAMBI	●	1T6966CA	1T6970CA

		3000K	H(m)	D(m)	E _{max} (lx)	
Ra97				34°		
Fixture Power	34W	1	0.61	3029		
Source Flux	3077lm	2	1.23	757		
Fixture Flux	1382lm	3	1.84	337		
Efficacy	40lm/W	4	2.45	189		
TS1116	I _{max} =984cd/klm	I _{max}	3029cd	5	3.07	121



Chapelle du Collège Sacha Leray Exposition

Photographer
Hugo Hebrard

Country
Carpentras - France

Accessories

Filter

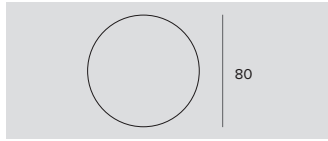

Filter	Ø	Code
Red	80	1T3424
Green	80	1T3425
Blue	80	1T3426
Yellow	80	1T3427
Magenta	80	1T3428

Flat glass interference chromatic filter.

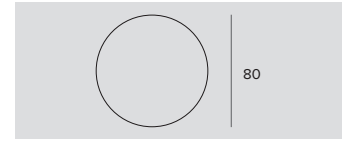

Ø	Code
80	1T3141

Flat glass, grooved refractive blade light filter.

This makes the beam take on an oval shape and when combined with spotlights, the light blade appears more prominent.

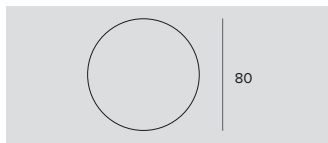

Ø	Code
80	1T3140

Flat glass micro prismatic refractive diffusive filter.
This softens the luminous effect.

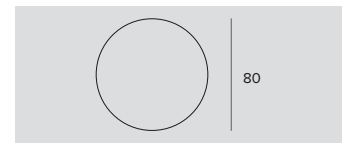

Filter	Ø	Code
Halogen +	80	1T6382
Vivid +	80	1T6384

Art filter.

Flat glass interference filter that can vary the colour parameters of the emission of the fixtures it is applied to.

To be used only with 3000K and Ra80 fixtures.

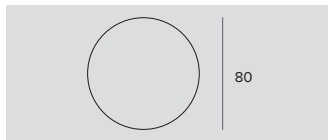

Filter	Ø	Code
Meat	80	1T6386
Fish	80	1T6388
Bread	80	1T6390
Vegetables	80	1T6392

Food filter.

Flat glass interference filter that can vary the colour parameters of the emission of the fixtures it is applied to.

1T6386

To be used only with 3000K and Ra80 fixtures.

1T6388

To be used only with 4000K and Ra80 fixtures.

1T6390

To be used only with 3000K and Ra80 fixtures.

1T6392

To be used only with 3000K and Ra80 fixtures.

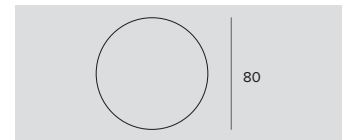

Filter	Ø	Code
Beauty	80	1T6394

Beauty filter.

Flat glass interference filter that can vary the colour parameters of the emission of the fixtures it is applied to.

To be used only with 3000K and Ra80 fixtures.

Screen

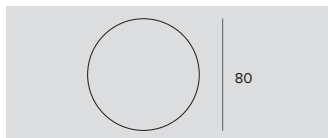

Ø	Code
80	1T6522

Protective screen.

Grid

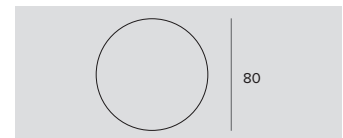

Ø	Code
80	1T3423

Anti-glare louver.

Black painted metal honeycomb structure.

LEDÒ

Zoom

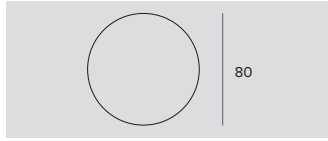

Ø	Code
80	1T3432

Zoom.

Optical system consists of an optical glass flat convex lens, an anodized aluminium specular reflector and a diffusive holographic filter.

To be used after removing the existing optic.

It makes it possible to obtain a variable beam from 15° to 60°.

It can not be used with NSP and hybrid optics; no for DBS version.

Cut-off

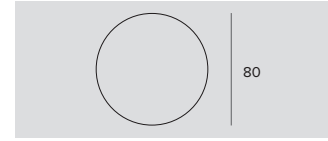

Ø	Code
80	1T3142

Cut-off Tube.

Allows for the beam to be focused while removing the fall-off component.

No for DBS version.

Screen

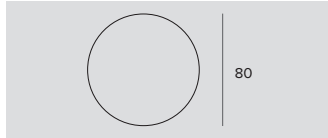

Ø	Code
80	1T3143

Black painted anodized diffusive aluminium asymmetric screen.

Complete with blade light filter.

Ideal for a Wall Washer effect.

To be combined with spot and flood optics.

Adapter



Ø	H	Driver	Colour	Code
100	32	EL.	○	1T2221
100	32	EL.	●	1T2220
100	32	EL.	●	1T2219

Ceiling mounting adapter for electrified track type projectors.

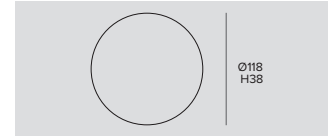

Ø	H	Driver	Colour	Code
118	38	DALI	○	9000/BPU-D-W
118	38	DALI	●	9000/BPU-D-B
118	38	DALI	●	9000/BPU-D-G

Ceiling mounting adapter for electrified track type projectors.

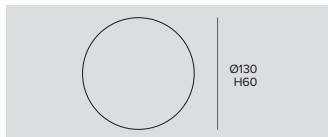

Cutout hole	Ø	H	Driver	Colour	Code
Ø105/125	130	60	EL.	○	1T2223
Ø105/125	130	60	EL.	●	1T2222
Ø105/125	130	60	EL.	●	1T2224

Recessed mounting adapter for electrified track type projectors.

1T2222 - To be completed with 1T2220.

1T2223 - To be completed with 1T2221.

1T2224 - To be completed with 1T2219.

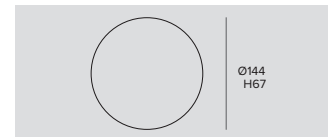

Cutout hole	Ø	H	Driver	Colour	Code
Ø125/130	144	67	DALI	○	9000/BRU-W
Ø125/130	144	67	DALI	●	9000/BRU-B
Ø125/130	144	67	DALI	●	9000/BRU-G

Recessed mounting adapter for electrified track type projectors.

9000/BRU-G - To be completed with 9000/BPU-D-G.

9000/BRU-W - To be completed with 9000/BPU-D-W.

9000/BRU-B - To be completed with 9000/BPU-D-B.



Tunable 2700K - 5700K

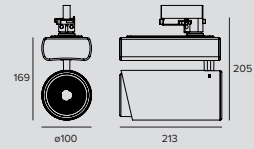

LED / 25W / SP								
	5000K	H(m)	D(m)	Emax(lx)	Driver	Colour	CTC	
	Ra90			14°	CASAMBI		1T4439CA	
	Fixture Power	29W	1	0.24	17965	CASAMBI		1T4443CA
	Source Flux	2290lm	2	0.48	4491	CASAMBI		1T4447CA
	Fixture Flux	1947lm	3	0.72	1996			
	Efficacy	67lm/W	4	0.96	1123			
TS1022	Imax=7845cd/klm	Imax	17965cd	5	1.20	719		

LED / 25W / FL								
	5000K	H(m)	D(m)	Emax(lx)	Driver	Colour	CTC	
	Ra90			27°	CASAMBI		1T4440CA	
	Fixture Power	29W	1	0.49	7070	CASAMBI		1T4444CA
	Source Flux	2290lm	2	0.97	1768	CASAMBI		1T4448CA
	Fixture Flux	1940lm	3	1.46	786			
	Efficacy	67lm/W	4	1.95	442			
TS1023	Imax=3087cd/klm	Imax	7070cd	5	2.43	283		

LED / 25W / MWFL								
	5000K	H(m)	D(m)	Emax(lx)	Driver	Colour	CTC	
	Ra90			45°	CASAMBI		1T4441CA	
	Fixture Power	29W	1	0.82	3722	CASAMBI		1T4445CA
	Source Flux	2290lm	2	1.64	931	CASAMBI		1T4449CA
	Fixture Flux	1990lm	3	2.46	414			
	Efficacy	69lm/W	4	3.28	233			
TS1024	Imax=1655cd/klm	Imax	3789cd	5	4.10	149		

LED / 25W / WFL								
	5000K	H(m)	D(m)	Emax(lx)	Driver	Colour	CTC	
	Ra90			59°	CASAMBI		1T4442CA	
	Fixture Power	29W	1	1.13	2590	CASAMBI		1T4446CA
	Source Flux	2290lm	2	2.26	647	CASAMBI		1T4450CA
	Fixture Flux	2018lm	3	3.39	288			
	Efficacy	70lm/W	4	4.51	162			
TS1025	Imax=1142cd/klm	Imax	2614cd	5	5.64	104		

Accessories

Filter			
		Ø	Code
		80	1T3141
		Ø	Code
		80	1T3140

Flat glass, grooved refractive blade light filter.
This makes the beam take on an oval shape and when combined with spotlights, the light blade appears more prominent.

Flat glass micro prismatic refractive diffusive filter.
This softens the luminous effect.



APE Museum

Cultural and museum center
of Monteparma Fondazione



Lighting Design
Pozzi Associati Luce

Photographer
Ivan Rossi

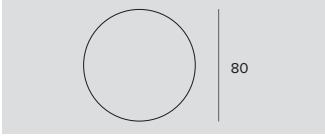
Country
Bologna - Italy

Screen					
					
		Ø		Code	
		80		1T6522	

Protective screen.

Grid					
					
		Ø		Code	
		80		1T3423	

Anti-glare louver.
Black painted metal honeycomb structure.

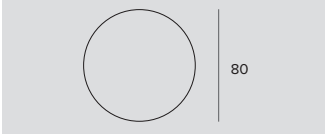
Zoom					
					
		Ø		Code	
		80		1T3432	

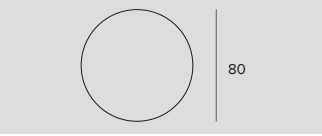

Zoom.
Optical system consists of an optical glass flat convex lens, an anodized aluminium specular reflector and a diffusive holographic filter.
To be used after removing the existing optic.
It makes it possible to obtain a variable beam from 15° to 60°.
It can not be used with NSP and hybrid optics; no for DBS version.

Cut-off					
					
		Ø		Code	
		80		1T3142	

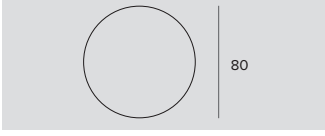
Cut-off Tube.
Allows for the beam to be focused while removing the fall-off component.
No for DBS version.

Screen					
					
		Ø		Code	
		80		1T3143	

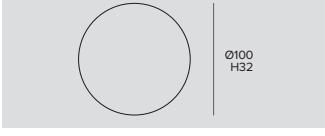
Black painted anodized diffusive aluminium asymmetric screen.
Complete with blade light filter.
Ideal for a Wall Washer effect.
To be combined with spot and flood optics.

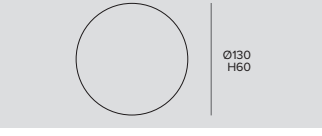
Adapter												
												
		Ø	H	Driver	Colour	Code	Ø	H	Driver	Colour	Code	
		100	32	EL.	○	1T2221	Ø105/125	130	60	EL.	○	1T2223
		100	32	EL.	●	1T2220	Ø105/125	130	60	EL.	●	1T2222
		100	32	EL.	●	1T2219	Ø105/125	130	60	EL.	●	1T2224

Ceiling mounting adapter for electrified track type projectors.

Recessed mounting adapter for electrified track type projectors.
1T2222 - To be completed with 1T2220.
1T2223 - To be completed with 1T2221.
1T2224 - To be completed with 1T2219.

RAY

GENERAL INFO

Professional adjustable LED projector.
Adjustable from 0° to -90° in the vertical plane and 359° in the horizontal plane. Mechanical aiming lock in vertical plane and graduated ring nut for locking in the horizontal plane. The centre of gravity always remains in axis with the track irrespective of where it is aimed.
RAY Ø163mm
RAY MINI Ø115mm
RAY MICRO Ø89mm

LED

Chip on board
From 1949lm to 7232lm
3000K – 4000K
Ra84
Ra97 (excluding the MICRO version)

PRODUCT EFFICACY

Up to 125lm/W

OPTICS

SP – FL – MWFL - WFL

POWER SUPPLY

Electronic – DALI ((excluding the MICRO version)

MATERIAL

Die-cast aluminium body painted. Front ring made of black ryton.

A range of projectors characterised by an essential design and high performance. Clearly intended for the Retail environment there are three different sizes and with four different power supplies to satisfy size and performance requirements within the same project.

All versions have optics with reflectors to obtain soft, delicate tones on all beam openings.





Almacruz Hotel

Lighting Design
Katerina Jofre

Photographer
Nicolás Saieh

Country
Santiago - Chile

Project
Mas Fernades
arquitectos
asociados

RAY

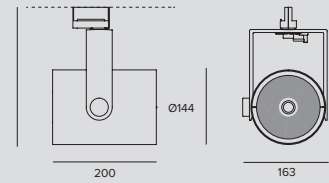

LED / 32W / REFLECTOR / SP / CRI84



		3000K	H(m)	D(m)	Emax(lx)	
		Ra84		12°		
Fixture Power	35W	1	0.21	59854		
Source Flux	4522lm	2	0.41	14963		
Fixture Flux	3861lm	3	0.62	6650		
Efficacy	111lm/W	4	0.82	3741		
TS742	Imax=13236cd/klm	Imax	59854cd	5	1.03	2394

Certificate	Driver	Colour	3000K	4000K
ENEC	EL.	○	1T3684	
ENEC	EL.	●	1T3685	
	DALI	○	1T3684DA	1T5321DA
	DALI	●	1T3685DA	1T5322DA
	EL.	○		1T5321
	EL.	●		1T5322

LED / 32W / REFLECTOR / SP / CRI97



		3000K	H(m)	D(m)	Emax(lx)	
		Ra97		12°		
Fixture Power	35W	1	0.21	45757		
Source Flux	3457lm	2	0.41	11439		
Fixture Flux	2952lm	3	0.62	5084		
Efficacy	85lm/W	4	0.82	2860		
TS742	Imax=13236cd/klm	Imax	45757cd	5	1.03	1830

Certificate	Driver	Colour	3000K	4000K
ENEC	EL.	○	1T4249	
ENEC	EL.	●	1T4250	
	DALI	○	1T4249DA	1T5329DA
	DALI	●	1T4250DA	1T5330DA
	EL.	○		1T5329
	EL.	●		1T5330

LED / 32W / REFLECTOR / FL / CRI84



		3000K	H(m)	D(m)	Emax(lx)	
		Ra84		25°		
Fixture Power	35W	1	0.45	15416		
Source Flux	4522lm	2	0.90	3854		
Fixture Flux	3776lm	3	1.35	1713		
Efficacy	109lm/W	4	1.80	964		
TS740	Imax=3409cd/klm	Imax	15416cd	5	2.25	617

Certificate	Driver	Colour	3000K	4000K
ENEC	EL.	○	1T3686	
ENEC	EL.	●	1T3687	
	DALI	○	1T3686DA	1T5323DA
	DALI	●	1T3687DA	1T5324DA
	EL.	○		1T5323
	EL.	●		1T5324

LED / 32W / REFLECTOR / FL / CRI97

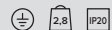

		3000K	H(m)	D(m)	Emax(lx)	
		Ra97		25°		
Fixture Power	35W	1	0.45	11785		
Source Flux	3457lm	2	0.90	2946		
Fixture Flux	2887lm	3	1.35	1309		
Efficacy	83lm/W	4	1.80	737		
TS740	Imax=3409cd/klm	Imax	11785cd	5	2.25	471

Certificate	Driver	Colour	3000K	4000K
ENEC	EL.	○	1T4251	
ENEC	EL.	●	1T4252	
	DALI	○	1T4251DA	1T5331DA
	DALI	●	1T4252DA	1T5332DA
	EL.	○		1T5331
	EL.	●		1T5332

LED / 50W / REFLECTOR / FL / CRI84

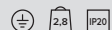

		3000K	H(m)	D(m)	Emax(lx)	
		Ra84		24°		
Fixture Power	54W	1	0.43	24335		
Source Flux	7050lm	2	0.85	6084		
Fixture Flux	5851lm	3	1.28	2704		
Efficacy	109lm/W	4	1.70	1521		
TS741	Imax=3452cd/klm	Imax	24335cd	5	2.13	973

Certificate	Driver	Colour	3000K	4000K
ENEC	EL.	○	1T3692	
ENEC	EL.	●	1T3693	
	DALI	○	1T3692DA	1T5325DA
	DALI	●	1T3693DA	1T5326DA
	EL.	○		1T5325
	EL.	●		1T5326

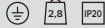
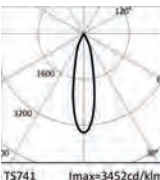
LED / 50W / REFLECTOR / FL / CRI97																																									
	3000K	H(m)	D(m)	Emax(lx)																																					
	Ra97		24°																																						
	Fixture Power	54W	1	0.43	18729																																				
	Source Flux	5426lm	2	0.85	4682																																				
	Fixture Flux	4503lm	3	1.28	2081																																				
	Efficacy	84lm/W	4	1.70	1171																																				
TS741	Imax=3452cd/klm	Imax	18729cd	5	2.13	749																																			
<table border="1"> <thead> <tr> <th>Certificate</th> <th>Driver</th> <th>Colour</th> <th>3000K</th> <th>4000K</th> </tr> </thead> <tbody> <tr> <td>ENEC</td> <td>EL.</td> <td>○</td> <td>1T4253</td> <td></td> </tr> <tr> <td>ENEC</td> <td>EL.</td> <td>●</td> <td>1T4254</td> <td></td> </tr> <tr> <td></td> <td>DALI</td> <td>○</td> <td>1T4253DA</td> <td>1T5333DA</td> </tr> <tr> <td></td> <td>DALI</td> <td>●</td> <td>1T4254DA</td> <td>1T5334DA</td> </tr> <tr> <td></td> <td>EL.</td> <td>○</td> <td></td> <td>1T5333</td> </tr> <tr> <td></td> <td>EL.</td> <td>●</td> <td></td> <td>1T5334</td> </tr> </tbody> </table>							Certificate	Driver	Colour	3000K	4000K	ENEC	EL.	○	1T4253		ENEC	EL.	●	1T4254			DALI	○	1T4253DA	1T5333DA		DALI	●	1T4254DA	1T5334DA		EL.	○		1T5333		EL.	●		1T5334
Certificate	Driver	Colour	3000K	4000K																																					
ENEC	EL.	○	1T4253																																						
ENEC	EL.	●	1T4254																																						
	DALI	○	1T4253DA	1T5333DA																																					
	DALI	●	1T4254DA	1T5334DA																																					
	EL.	○		1T5333																																					
	EL.	●		1T5334																																					

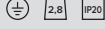
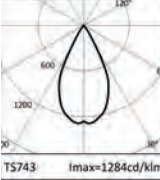
LED / 50W / REFLECTOR / WFL / CRI84																																									
	3000K	H(m)	D(m)	Emax(lx)																																					
	Ra84		53°																																						
	Fixture Power	54W	1	0.99	9030																																				
	Source Flux	7050lm	2	1.97	2257																																				
	Fixture Flux	5781lm	3	2.96	1003																																				
	Efficacy	108lm/W	4	3.95	564																																				
TS743	Imax=1284cd/klm	Imax	9049cd	5	4.93	361																																			
<table border="1"> <thead> <tr> <th>Certificate</th> <th>Driver</th> <th>Colour</th> <th>3000K</th> <th>4000K</th> </tr> </thead> <tbody> <tr> <td>ENEC</td> <td>EL.</td> <td>○</td> <td>1T3694</td> <td></td> </tr> <tr> <td>ENEC</td> <td>EL.</td> <td>●</td> <td>1T3695</td> <td></td> </tr> <tr> <td></td> <td>DALI</td> <td>○</td> <td>1T3694DA</td> <td>1T5327DA</td> </tr> <tr> <td></td> <td>DALI</td> <td>●</td> <td>1T3695DA</td> <td>1T5328DA</td> </tr> <tr> <td></td> <td>EL.</td> <td>○</td> <td></td> <td>1T5327</td> </tr> <tr> <td></td> <td>EL.</td> <td>●</td> <td></td> <td>1T5328</td> </tr> </tbody> </table>							Certificate	Driver	Colour	3000K	4000K	ENEC	EL.	○	1T3694		ENEC	EL.	●	1T3695			DALI	○	1T3694DA	1T5327DA		DALI	●	1T3695DA	1T5328DA		EL.	○		1T5327		EL.	●		1T5328
Certificate	Driver	Colour	3000K	4000K																																					
ENEC	EL.	○	1T3694																																						
ENEC	EL.	●	1T3695																																						
	DALI	○	1T3694DA	1T5327DA																																					
	DALI	●	1T3695DA	1T5328DA																																					
	EL.	○		1T5327																																					
	EL.	●		1T5328																																					

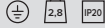
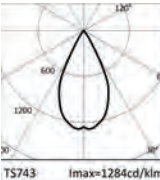
LED / 50W / REFLECTOR / WFL / CRI97																																									
	3000K	H(m)	D(m)	Emax(lx)																																					
	Ra97		53°																																						
	Fixture Power	54W	1	0.99	6950																																				
	Source Flux	5426lm	2	1.97	1737																																				
	Fixture Flux	4449lm	3	2.96	772																																				
	Efficacy	83lm/W	4	3.95	434																																				
TS743	Imax=1284cd/klm	Imax	6965cd	5	4.93	278																																			
<table border="1"> <thead> <tr> <th>Certificate</th> <th>Driver</th> <th>Colour</th> <th>3000K</th> <th>4000K</th> </tr> </thead> <tbody> <tr> <td>ENEC</td> <td>EL.</td> <td>○</td> <td>1T4255</td> <td></td> </tr> <tr> <td>ENEC</td> <td>EL.</td> <td>●</td> <td>1T4256</td> <td></td> </tr> <tr> <td></td> <td>DALI</td> <td>○</td> <td>1T4255DA</td> <td>1T5335DA</td> </tr> <tr> <td></td> <td>DALI</td> <td>●</td> <td>1T4256DA</td> <td>1T5336DA</td> </tr> <tr> <td></td> <td>EL.</td> <td>○</td> <td></td> <td>1T5335</td> </tr> <tr> <td></td> <td>EL.</td> <td>●</td> <td></td> <td>1T5336</td> </tr> </tbody> </table>							Certificate	Driver	Colour	3000K	4000K	ENEC	EL.	○	1T4255		ENEC	EL.	●	1T4256			DALI	○	1T4255DA	1T5335DA		DALI	●	1T4256DA	1T5336DA		EL.	○		1T5335		EL.	●		1T5336
Certificate	Driver	Colour	3000K	4000K																																					
ENEC	EL.	○	1T4255																																						
ENEC	EL.	●	1T4256																																						
	DALI	○	1T4255DA	1T5335DA																																					
	DALI	●	1T4256DA	1T5336DA																																					
	EL.	○		1T5335																																					
	EL.	●		1T5336																																					

Accessories

Screen

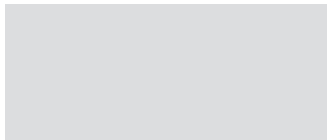
Code
1T6523

Protective screen.

Grid

Code
1T6918

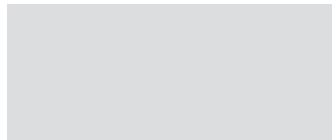
Anti-glare louver.
Black painted metal honeycomb structure.

Ray Shade



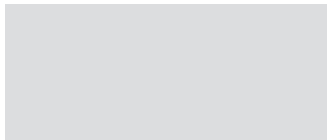

Code
1T3696

Adjustable barn doors flaps.

RAY

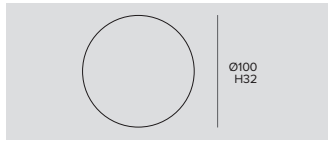
Adapter



Ø	H	Driver	Colour	Code
100	32	EL.	○	1T2221
100	32	EL.	●	1T2220
100	32	EL.	●	1T2219

Ceiling mounting adapter for electrified track type projectors.

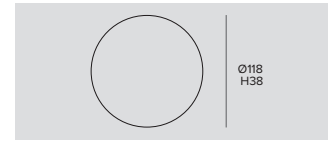

Ø	H	Driver	Colour	Code
118	38	DALI	○	9000/BPU-D-W
118	38	DALI	●	9000/BPU-D-B
118	38	DALI	●	9000/BPU-D-G

Ceiling mounting adapter for electrified track type projectors.

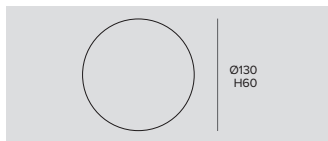

Cutout hole	Ø	H	Driver	Colour	Code
Ø105/125	130	60	EL.	○	1T2223
Ø105/125	130	60	EL.	●	1T2222
Ø105/125	130	60	EL.	●	1T2224

Recessed mounting adapter for electrified track type projectors.

1T2222 - To be completed with 1T2220.

1T2223 - To be completed with 1T2221.

1T2224 - To be completed with 1T2219.

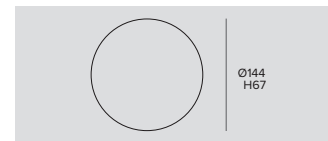

Cutout hole	Ø	H	Driver	Colour	Code
Ø125/130	144	67	DALI	○	9000/BRU-W
Ø125/130	144	67	DALI	●	9000/BRU-B
Ø125/130	144	67	DALI	●	9000/BRU-G

Recessed mounting adapter for electrified track type projectors.

9000/BRU-G - To be completed with 9000/BPU-D-G.

9000/BRU-W - To be completed with 9000/BPU-D-W.

9000/BRU-B - To be completed with 9000/BPU-D-B.



Mini

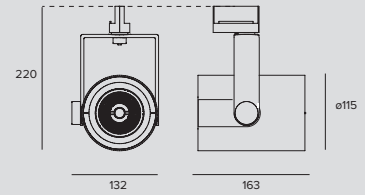

LED / 30W / REFLECTOR / SP / CRI84



		3000K	H(m)	D(m)	Emax(lx)
		Ra84		14°	
Fixture Power	32W	1	0.24	33623	
Source Flux	4141lm	2	0.48	8406	
Fixture Flux	3520lm	3	0.72	3736	
Efficacy	111lm/W	4	0.96	2101	
TS832	Imax=8119cd/klm	Imax	33623cd	5	1345

Certificate	Driver	Colour	3000K	4000K
ENEC	EL.	○	1T4201	
ENEC	EL.	●	1T4197	
	DALI	○	1T4201DA	1T5340DA
	DALI	●	1T4197DA	1T5337DA
	EL.	○		1T5340
	EL.	●		1T5337

LED / 30W / REFLECTOR / SP / CRI97



		3000K	H(m)	D(m)	Emax(lx)
		Ra97		14°	
Fixture Power	32W	1	0.24	25276	
Source Flux	3113lm	2	0.48	6319	
Fixture Flux	2646lm	3	0.72	2808	
Efficacy	83lm/W	4	0.96	1580	
TS832	Imax=8119cd/klm	Imax	25276cd	5	1011

Certificate	Driver	Colour	3000K	4000K
ENEC	EL.	○	1T4260	
ENEC	EL.	●	1T4257	
	DALI	○	1T4260DA	1T5346DA
	DALI	●	1T4257DA	1T5343DA
	EL.	○		1T5346
	EL.	●		1T5343

LED / 30W / REFLECTOR / FL / CRI84



		3000K	H(m)	D(m)	Emax(lx)
		Ra84		25°	
Fixture Power	32W	1	0.44	14085	
Source Flux	4141lm	2	0.88	3521	
Fixture Flux	3505lm	3	1.32	1565	
Efficacy	110lm/W	4	1.76	880	
TS833	Imax=3401cd/klm	Imax	14085cd	5	563

Certificate	Driver	Colour	3000K	4000K
ENEC	EL.	○	1T4202	
ENEC	EL.	●	1T4198	
	DALI	○	1T4202DA	1T5341DA
	DALI	●	1T4198DA	1T5338DA
	EL.	○		1T5341
	EL.	●		1T5338

LED / 30W / REFLECTOR / FL / CRI97



		3000K	H(m)	D(m)	Emax(lx)
		Ra97		25°	
Fixture Power	32W	1	0.44	10588	
Source Flux	3113lm	2	0.88	2647	
Fixture Flux	2635lm	3	1.32	1176	
Efficacy	83lm/W	4	1.76	662	
TS833	Imax=3401cd/klm	Imax	10588cd	5	424

Certificate	Driver	Colour	3000K	4000K
ENEC	EL.	○	1T4261	
ENEC	EL.	●	1T4258	
	DALI	○	1T4261DA	1T5347DA
	DALI	●	1T4258DA	1T5344DA
	EL.	○		1T5347
	EL.	●		1T5344

LED / 30W / REFLECTOR / MWFL / CRI84



		3000K	H(m)	D(m)	Emax(lx)
		Ra84		45°	
Fixture Power	32W	1	0.84	6295	
Source Flux	4141lm	2	1.67	1574	
Fixture Flux	3599lm	3	2.51	699	
Efficacy	113lm/W	4	3.35	393	
TS834	Imax=1528cd/klm	Imax	6327cd	5	252

Certificate	Driver	Colour	3000K	4000K
ENEC	EL.	○	1T4203	
ENEC	EL.	●	1T4199	
	DALI	○	1T4203DA	1T5342DA
	DALI	●	1T4199DA	1T5339DA
	EL.	○		1T5342
	EL.	●		1T5339

LED / 30W / REFLECTOR / MWFL / CRI97



	3000K	H(m)	D(m)	E _{max} (lx)		
	Ra97		45°			
	Fixture Power	32W	1	0.84	4733	
	Source Flux	3113lm	2	1.67	1183	
	Fixture Flux	2705lm	3	2.51	526	
	Efficacy	85lm/W	4	3.35	296	
TS834	I _{max} =1528cd/klm	I _{max}	4757cd	5	4.18	189

Certificate	Driver	Colour	3000K	4000K
ENEC	EL.	○	1T4262	
ENEC	EL.	●	1T4259	
	DALI	○	1T4262DA	1T5348DA
	DALI	●	1T4259DA	1T5345DA
	EL.	○		1T5348
	EL.	●		1T5345

Accessories

Filter

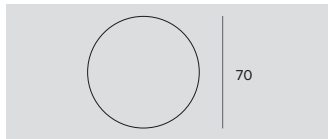

Filter	Ø	Code
Red	70	1T1712
Green	70	1T1713
Blue	70	1T1714
Yellow	70	1T1715
Magenta	70	1T1716

Flat glass interference chromatic filter.
To be completed with an additional holder ring.

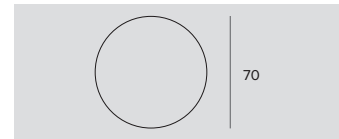

Ø	Code
70	1T1708

Flat striped glass blade light refractive filter.
This makes the beam take on an oval shape and when combined with spotlights, the light blade appears more prominent.
To be completed with an additional holder ring.

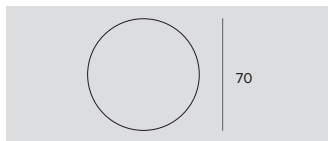

Ø	Code
70	1T1709

Flat glass wired refractive diffusive filter.
This softens the luminous effect.
To be completed with an additional holder ring.

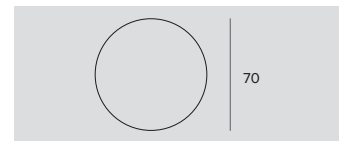

Filter	Ø	Code
Halogen +	70	1T6506
Vivid +	70	1T6507

Art filter.
Flat glass interference filter that can vary the colour parameters of the emission of the fixtures it is applied to.
To be used only with 3000K and Ra80 fixtures.
To be completed with an additional holder ring.

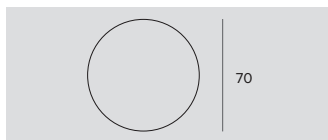

Filter	Ø	Code
Meat	70	1T6508
Fish	70	1T6509
Bread	70	1T6510
Vegetables	70	1T6511

Food filter.
Flat glass interference filter that can vary the colour parameters of the emission of the fixtures it is applied to.
To be completed with an additional holder ring .
1T6508
To be used only with 3000K and Ra80 fixtures.
1T6509
To be used only with 4000K and Ra80 fixtures.
1T6510
To be used only with 3000K and Ra80 fixtures.
1T6511
To be used only with 3000K and Ra80 fixtures.

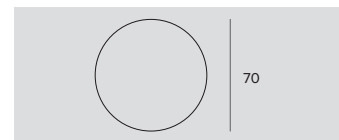

Filter	Ø	Code
Beauty	70	1T6512

Beauty filter.
Flat glass interference filter that can vary the colour parameters of the emission of the fixtures it is applied to.
To be used only with 3000K and Ra80 fixtures.
To be completed with an additional holder ring.

Screen

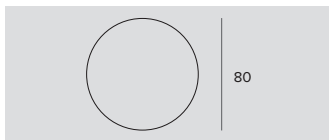

Ø	Code
80	1T6522

Protective screen.

Zoom

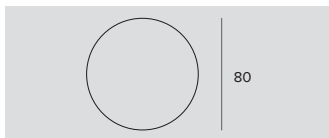

Ø	Code
80	1T3432

Zoom.
Optical system consists of an optical glass flat convex lens, an anodized aluminium specular reflector and a diffusive holographic filter.
To be used after removing the existing optic.
It makes it possible to obtain a variable beam from 15° to 60°.
It can not be used with NSP and hybrid optics; no for DBS version.

Screen

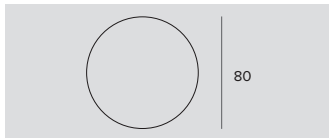

Ø	Code
80	1T3143

Black painted anodized diffusive aluminium asymmetric screen.
Complete with blade light filter.
Ideal for a Wall Washer effect.
To be combined with spot and flood optics.

Grid

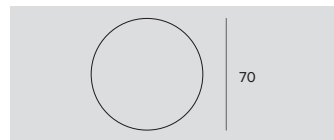

Ø	Code
70	1T1711

Anti-glare louver.
Black painted metal honeycomb structure.
To be completed with an additional holder ring for Cloud, Ray Mini, Store, Label 9 and Keplero Mini HE.

Cut-off

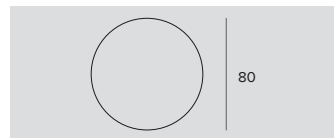

Ø	Code
80	1T3142

Cut-off Tube.
Allows for the beam to be focused while removing the fall-off component.
No for DBS version.

Holder Ring

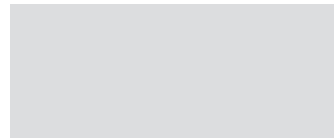

Code
1T3727

Transparent polycarbonate accessory holder ring.

Adapter

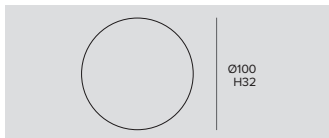

Ø	H	Driver	Colour	Code
100	32	EL.	○	1T2221
100	32	EL.	●	1T2220
100	32	EL.	●	1T2219

Ceiling mounting adapter for electrified track type projectors.

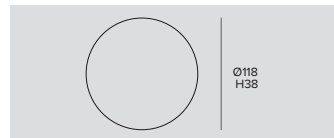

Ø	H	Driver	Colour	Code
118	38	DALI	○	9000/BPU-D-W
118	38	DALI	●	9000/BPU-D-B
118	38	DALI	●	9000/BPU-D-G

Ceiling mounting adapter for electrified track type projectors.

RAY

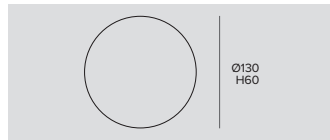

Cutout hole	Ø	H	Driver	Colour	Code
Ø105/125	130	60	EL.	○	1T2223
Ø105/125	130	60	EL.	●	1T2222
Ø105/125	130	60	EL.	●	1T2224

Recessed mounting adapter for electrified track type projectors.

1T2222 - To be completed with 1T2220.

1T2223 - To be completed with 1T2221.

1T2224 - To be completed with 1T2219.

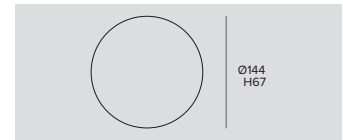

Cutout hole	Ø	H	Driver	Colour	Code
Ø125/130	144	67	DALI	○	9000/BRU-W
Ø125/130	144	67	DALI	●	9000/BRU-B
Ø125/130	144	67	DALI	●	9000/BRU-G

Recessed mounting adapter for electrified track type projectors.

9000/BRU-G - To be completed with 9000/BPU-D-G.

9000/BRU-W - To be completed with 9000/BPU-D-W.

9000/BRU-B - To be completed with 9000/BPU-D-B.



Motorvillage

Architect
Juan José Aristegui

Photographer
Cristina Motilla

Country
Lisboa - Portugal

RAY



Micro

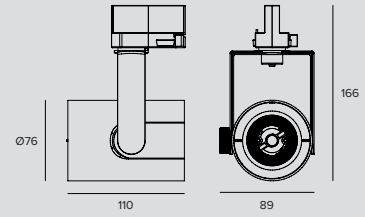

LED / 12W / REFLECTOR / SP



	3000K	H(m)	D(m)	Emax(lx)		
	Ra84		17°			
	Fixture Power	13W	1	0.30	9777	
	Source Flux	1949lm	2	0.59	2444	
	Fixture Flux	1501lm	3	0.89	1086	
	Efficacy	113lm/W	4	1.19	611	
TS989	Imax=5017cd/klm	Imax	9777cd	5	1.48	391

Driver	Colour	3000K	4000K
EL.	○	1T6317	1T6319
EL.	●	1T6318	1T6320

LED / 12W / REFLECTOR / MWFL



	3000K	H(m)	D(m)	Emax(lx)		
	Ra84		48°			
	Fixture Power	13W	1	0.90	2626	
	Source Flux	1949lm	2	1.80	657	
	Fixture Flux	1613lm	3	2.69	292	
	Efficacy	121lm/W	4	3.59	164	
TS990	Imax=1372cd/klm	Imax	2673cd	5	4.49	105

Driver	Colour	3000K	4000K
EL.	○	1T6321	1T6323
EL.	●	1T6322	1T6324

Accessories

Filter

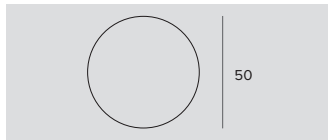

Filter	Ø	Code
Red	50	49881
Green	50	49882
Blue	50	49886
Yellow	50	49887
Magenta	50	49959

Flat glass interference chromatic filter.

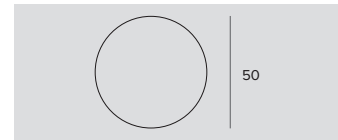

Ø	Code
50	1T4721

PMMA holographic filter with blade effect to ovalize the light beam; more evident when combined with spot and flood optics.

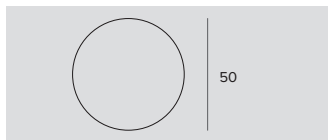

Filter	Ø	Code
Halogen +	50	1T6381
Vivid +	50	1T6383

Art filter.

Flat glass interference filter that can vary the colour parameters of the emission of the fixtures it is applied to.
To be used only with 3000K and Ra80 fixtures.

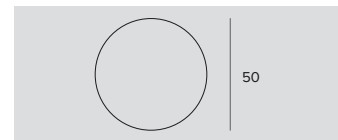

Filter	Ø	Code
Meat	50	1T6385
Fish	50	1T6387
Bread	50	1T6389
Vegetables	50	1T6391

Food filter.

Flat glass interference filter that can vary the colour parameters of the emission of the fixtures it is applied to.

1T6385

To be used only with 3000K and Ra80 fixtures.

1T6387

To be used only with 4000K and Ra80 fixtures.

1T6389

To be used only with 3000K and Ra80 fixtures.

1T6391

To be used only with 3000K and Ra80 fixtures.

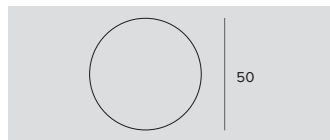

Filter	Ø	Code
Beauty	50	1T6393

Beauty filter.
Flat glass interference filter that can vary the colour parameters of the emission of the fixtures it is applied to.
To be used only with 3000K and Ra80 fixtures.

Screen

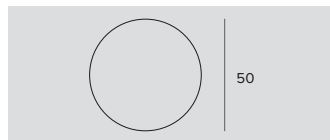

Ø	Code
50	1T6521

Protective screen.

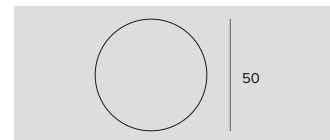

Ø	Code
50	1T4325

Black painted anodized diffusive aluminium asymmetric screen.
Complete with blade light filter.
Ideal for a Wall Washer effect.
To be combined with spot and flood optics.

Grid

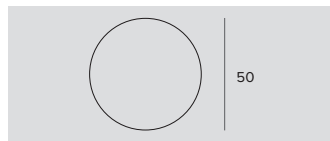

Ø	Code
50	1T4322

Anti-glare louver.
Black painted metal honeycomb structure.
Complete with holographic diffusion filter.

Zoom

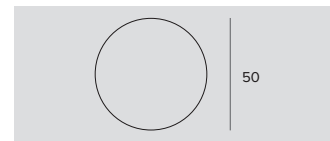

Ø	Code
50	1T4324

Zoom.
Optical system consists of an optical glass flat convex lens, an anodized aluminium specular reflector and a diffusive holographic filter.
To be used after removing the existing optic.
It can not be used with a narrow spot optic.
It makes it possible to obtain a variable beam from 15° to 60°.

Adapter

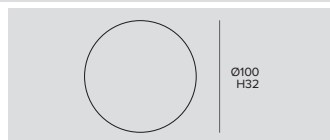

Ø	H	Driver	Colour	Code
100	32	EL.	○	1T2221
100	32	EL.	●	1T2220
100	32	EL.	●	1T2219

Ceiling mounting adapter for electrified track type projectors.

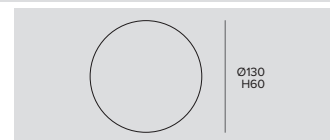

Cutout hole	Ø	H	Driver	Colour	Code
Ø105/125	130	60	EL.	○	1T2223
Ø105/125	130	60	EL.	●	1T2222
Ø105/125	130	60	EL.	●	1T2224

Recessed mounting adapter for electrified track type projectors.
1T2222 - To be completed with 1T2220.
1T2223 - To be completed with 1T2221.
1T2224 - To be completed with 1T2219.

EUROSTANDARD

Plus

GENERAL INFO

Eurostandard Plus 230V track.
L. 1000mm – 2000mm – 3000mm

POWER SUPPLY

Electronic – DALI

MATERIAL

Electrified track in three lengths in extruded anodized aluminum or in extruded painted aluminium.
Conductors in copper insulated in PVC.

The Eurostandard Plus is a universal 230V track that is compatible with all projectors in the Targetti collection and with all projectors that conform with European standards.

A standard double and recessed version in three different lengths. It has a double fixing systems for ceiling and suspension installations with joints of various sizes and configurations to obtain infinite compositions.

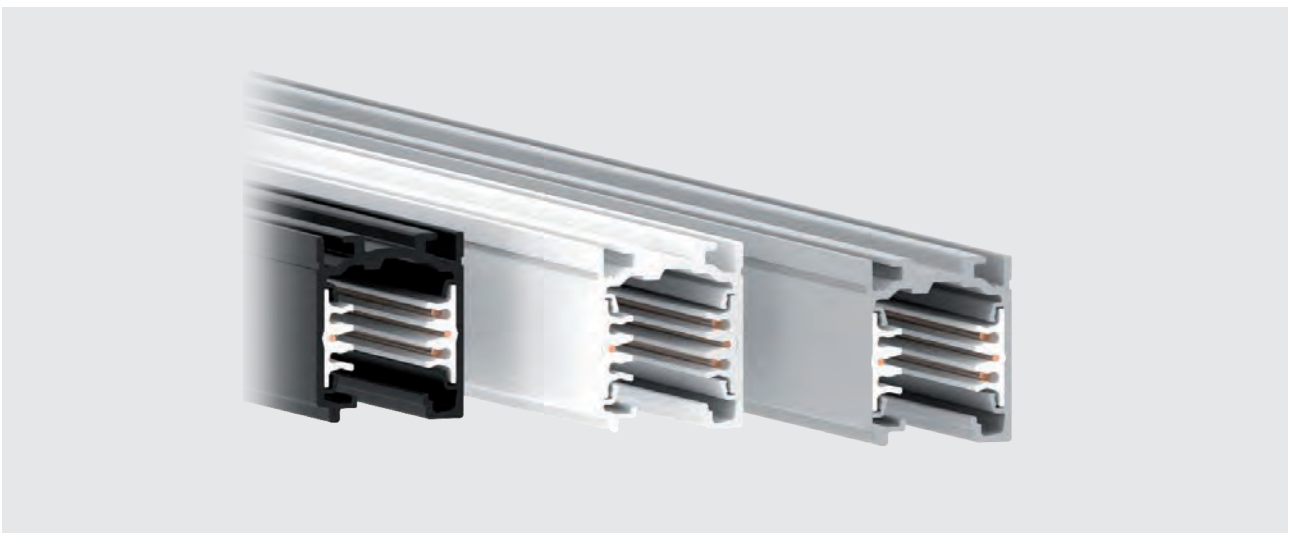



Standard

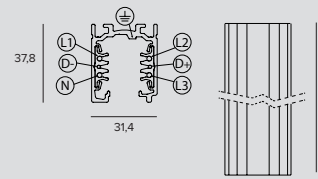

STANDARD BNEC

	Kg	L	Colour	Code
	1.1	1000	○	9000-1/W-ST
	1.1	1000	●	9000-1/B-ST
	1.1	1000	●	9000-1/G-ST
	2.1	2000	○	9000-2/W-ST
	2.1	2000	●	9000-2/B-ST
	2.1	2000	●	9000-2/G-ST
	3.1	3000	○	9000-3/W-ST
	3.1	3000	●	9000-3/B-ST
	3.1	3000	●	9000-3/G-ST



Recessed

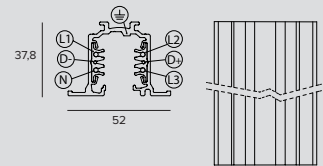

RECESSED BNEC

	Kg	L	Colour	Code
	1.1	1000	○	9000-1/W-R
	1.1	1000	●	9000-1/B-R
	1.1	1000	●	9000-1/G-R
	2.2	2000	○	9000-2/W-R
	2.2	2000	●	9000-2/B-R
	2.2	2000	●	9000-2/G-R
	3.4	3000	○	9000-3/W-R
	3.4	3000	●	9000-3/B-R
	3.4	3000	●	9000-3/G-R

Related codes

End Caps

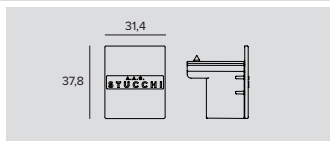

Colour	Code
○	9004/W
●	9004/B
●	9004/G

Dead end - Standard.

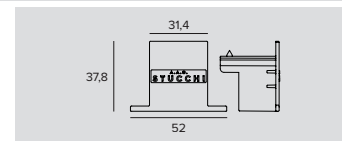

Colour	Code
○	9004-R/W
●	9004-R/B
●	9004-R/G

Dead end - recessed.

EUROSTANDARD PLUS

Mounting System

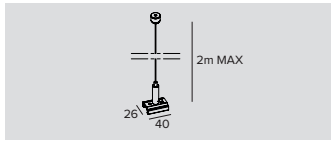

Code

S-9000KIT

Suspension kit.
L=2000mm

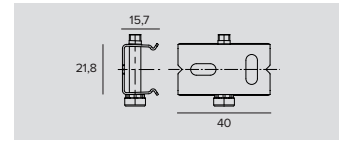

Code

S-9000/111

Ceiling mounting bracket.
Galvanized steel.

Power Supply

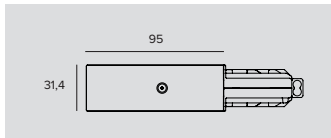

Colour	Code
○	9001/W
●	9001/B
●	9001/G

Lateral power supply.
Polarity on the right.

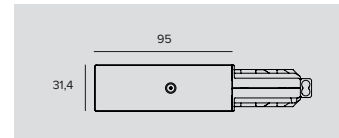

Colour	Code
○	9002/W
●	9002/B
●	9002/G

Lateral power supply.
Polarity on the left.

Accessories

End Caps

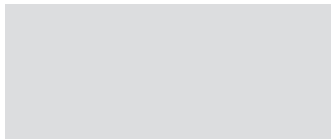

Colour	Code
○	S-9001/115-W
●	S-9001/115-B

Seal for lateral power supply.
PVC.
For: 9001/...; 9002/...

Bracket

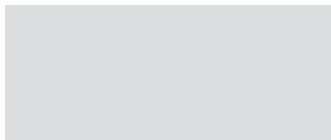
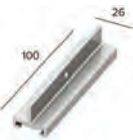

Colour	Code
●	S-9000/123

Rigid support bracket.

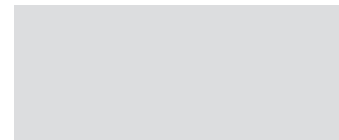

Driver	Colour	Code
EL.	○	1T7007
EL.	●	1T7005
EL.	●	1T7009
DALI	○	1T7006
DALI	●	1T7004
DALI	●	1T7008

Straight coupler for stability. For projectors with Eurostandard Plus.

Tool



Code
S-9000/T

Tool for shearing conductors, to be used if necessary to cut the track during installation.

Power Supply



Colour	Code
<input type="radio"/>	9010/W
<input type="radio"/>	9010/B
<input type="radio"/>	9010/G

Central power supply.

Electrical Connector



Colour	Code
<input type="radio"/>	9003/W
<input type="radio"/>	9003/B
<input type="radio"/>	9003/G

Linear joint.



Colour	Code
<input type="radio"/>	9018/W
<input type="radio"/>	9018/B
<input type="radio"/>	9018/G

Flexible joint.



Colour	Code
<input type="radio"/>	9011/W
<input type="radio"/>	9011/B
<input type="radio"/>	9011/G

L joint.
Internal polarity.



Colour	Code
<input type="radio"/>	9012/W
<input type="radio"/>	9012/B
<input type="radio"/>	9012/G

L joint.
External polarity.



Colour	Code
<input type="radio"/>	9013/W
<input type="radio"/>	9013/B
<input type="radio"/>	9013/G

T joint.
External polarity and on the left.



Colour	Code
<input type="radio"/>	9014/W
<input type="radio"/>	9014/B
<input type="radio"/>	9014/G

T joint.
External polarity and on the right.



Colour	Code
<input type="radio"/>	9015/W
<input type="radio"/>	9015/B
<input type="radio"/>	9015/G

T joint.
Internal polarity and on the left.



Colour	Code
<input type="radio"/>	9016/W
<input type="radio"/>	9016/B
<input type="radio"/>	9016/G

T joint.
Internal polarity and on the right.

EUROSTANDARD PLUS

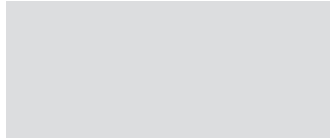

Colour	Code
	9017/W
	9017/B
	9017/G

X joint.

Mounting System

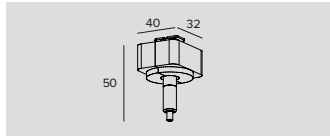

Colour	Code
	S-9000/M-W-KIT
	S-9000/M-B-KIT
	S-9000/M-G-KIT

Adapter for suspension installation.

Adapter

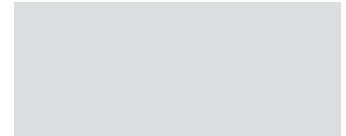

Colour	Code
	9009/W
	9009/B
	9009/G

Adapter for power supply.
Allows for power supply from a Eurostandard Plus track.

Cover Panel

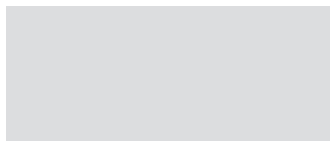

Colour	Code
	S-9001-R/6-W
	S-9001-R/6-B
	S-9001-R/6-G

False ceiling cover for lateral power supply.
Polycarbonate body.
For: 9001/...; 9002/...

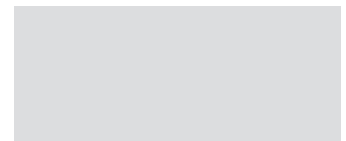

Colour	Code
	S-9010-R/6-W
	S-9010-R/6-B
	S-9010-R/6-G

False ceiling cover for central power supply.
Polycarbonate body.
For: 9010/...

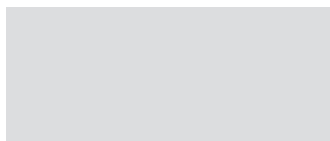

Colour	Code
	S-9011-R/6-W
	S-9011-R/6-B
	S-9011-R/6-G

False ceiling cover for L connector.
Polycarbonate body.
For: 9011/...; 9012/...

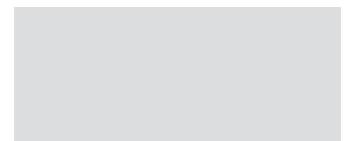

Colour	Code
	S-9013-R/6-W
	S-9013-R/6-B
	S-9013-R/6-G

False ceiling cover for T connector.
Polycarbonate body.
For: 9013/...; 9014/...; 9015/...; 9016/...

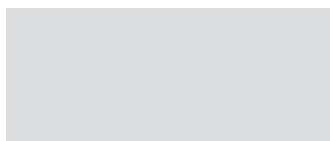
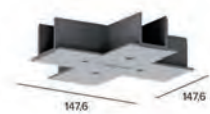

Colour	Code
	S-9017-R/6-W
	S-9017-R/6-B
	S-9017-R/6-G

False ceiling cover for X connector.
Polycarbonate body.
For: 9017.

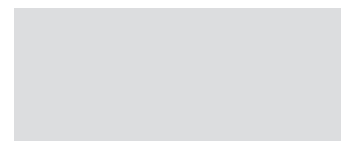

L	Colour	Code
1000		S-9000/GP-W
1000		S-9000/GP-B
1000		S-9000/GP-G

Cover profile.

ELECTRICAL SCHEME

During the wiring the electrical scheme of picture must be followed.

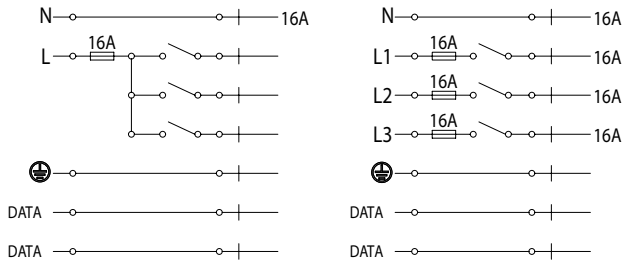

LOAD SCHEME

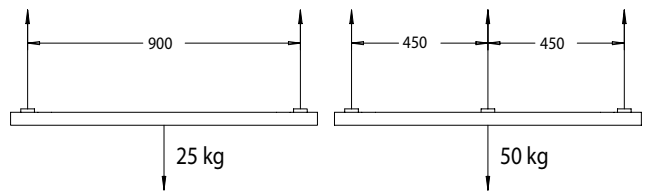

INSTALLATION

There is a polarity on the lighting track to guarantee the right connection of the multiple pieces of the track. Also end-feeds and connection joints have a polarity that must be taken into account in order to choose the right component. In the catalogue sketches of this articles, the position of the polarity is highlighted with a red line.

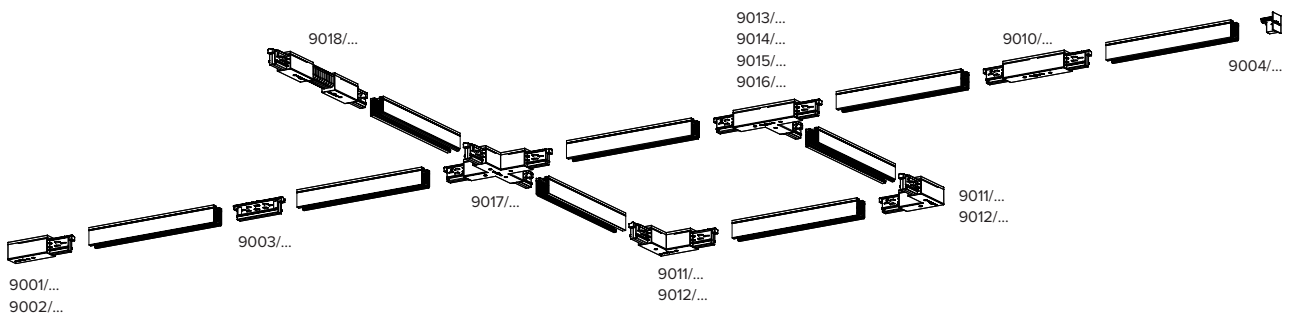

LATERAL POWER SUPPLIES

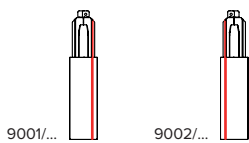

CENTRAL POWER SUPPLIES

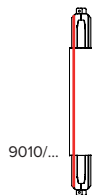

"L" JOINT

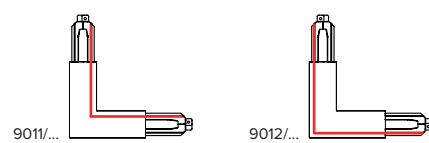

"T" JOINT

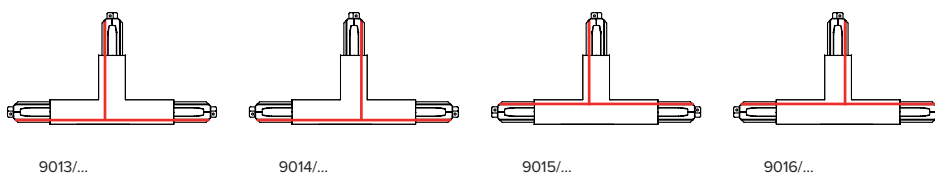

"X" JOINT

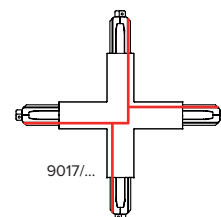

JEDI

Compact Indoor

GENERAL INFO

Adjustable linear LEC projector.
41x37,5mm (excluded driver)
41x79mm (included driver)
Lunghezze 300mm – 600mm
900mm – 1200mm

LED

Linear boards
From 1410lm to 6360lm
2700K – 3000K – 3500K – 4000K
Ra90

PRODUCT EFFICACY

Up to 106lm/W

OPTICS

FL – GRAZING – WALL WASHER

POWER SUPPLY

Electronic – DALI
Casambi control: the DALI version is fitted with special accessories.

MATERIAL

Extruded anodised aluminium 15µ body. 1.8mm thick polycarbonate removable (to insert accessories) flat screen. Removable driver box. The body of the fixture is adjustable and can be installed away from the mounting surface using accessory brackets.

Is the compact, high performance linear LED fixture, suitable for installation in small grooves or on particularly thin frames. Depending on the chosen optic it is suitable for general lighting in pedestrian area, vaulted ceilings and vertical surfaces. It is complete with a removable driver to be positioned in the event of installation in reduced spaces. The L. 300mm version is also complete with a remote driver.

If equipped with special brackets the projector can be adjusted up to +/-145°.

Also available in an IP67 outdoor version.





Sala Zuccari

Palazzo Giustiniani

Photographer
Alessandro Maurelli

Country
Rome - Italy

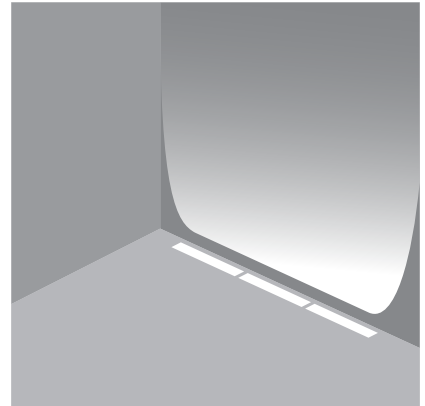
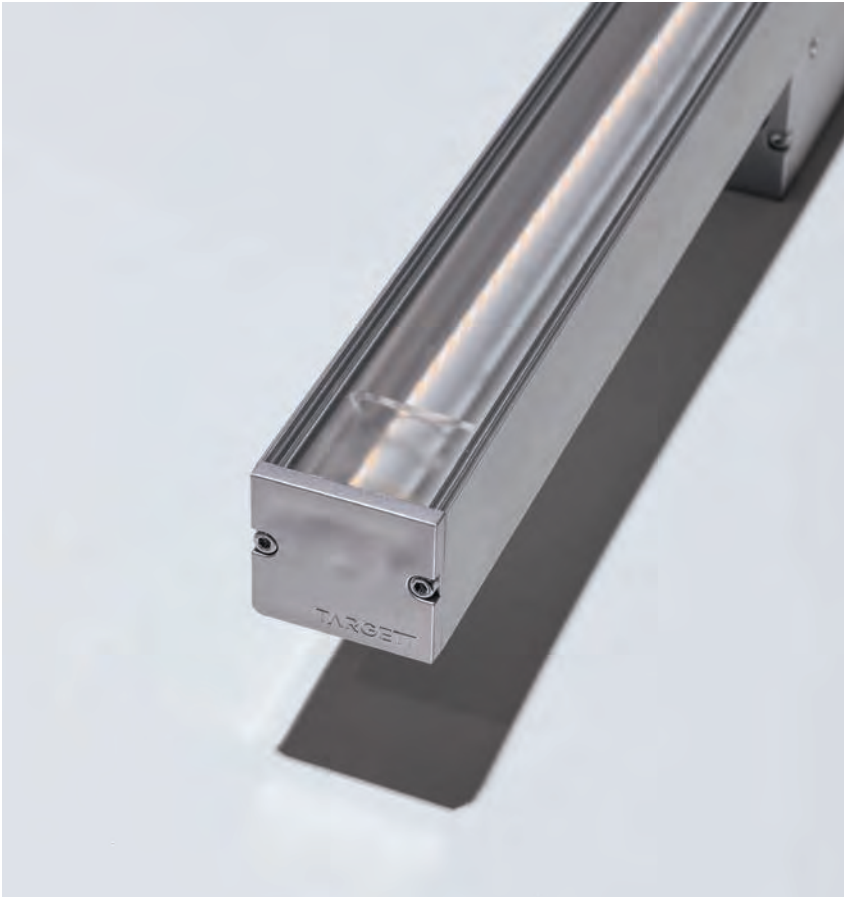

Grazing



Wall washer

The extensive range of optics

Makes it possible to obtain different lighting effects according to needs and installation type. It is also possible to accessorise it with a special grill that in addition to limiting any risk of glare, also makes it possible to modify the beam emission and create other lighting effects.



Flood



The Grazing optic versions

Is the most suitable solution for lighting vertical surfaces. Installed in continuous rows it makes it possible to obtain seamless uniform lighting.

Wide rotation

If equipped with special brackets the projector can be adjusted up to $\pm 145^\circ$.

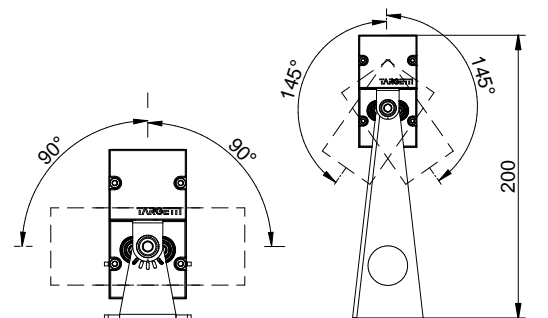

JEDI COMPACT



IP40 Remote driver L. 289mm

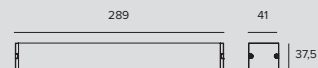

LED / 12W / FLOOD



		3000K	H(m)	D1(m)	D2(m)	E _{max} (lx)	
Ra90				85°	32°		
Fixture Power	14W	1	1.84	0.57	1049		
Source Flux	1500lm	2	3.68	1.14	262		
Fixture Flux	1121lm	3	5.52	1.70	117		
Efficacy	80lm/W	4	7.36	2.27	66		
TS1078	I _{max} =700cd/klm	I _{max}	1049cd	5	9.20	2.84	42

Power Supply	Colour	2700K	3000K	3500K	4000K
500mA	●	1T6747	1T6748	1T6749	1T6750

LED / 12W / GRAZING



		3000K	H(m)	D1(m)	D2(m)	E _{max} (lx)	
Ra90				76°	15°		
Fixture Power	14W	1	1.55	0.26	2403		
Source Flux	1500lm	2	3.10	0.51	601		
Fixture Flux	1247lm	3	4.65	0.77	267		
Efficacy	89lm/W	4	6.21	1.02	150		
TS1080	I _{max} =1602cd/klm	I _{max}	2403cd	5	7.76	1.28	96

Power Supply	Colour	2700K	3000K	3500K	4000K
500mA	●	1T6751	1T6752	1T6753	1T6754

LED / 12W / WALL WASHER

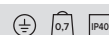

		3000K	H(m)	D1(m)	D2(m)	E _{max} (lx)	
Ra90				115°	59°		
Fixture Power	14W	1	3.12	1.34	1009		
Source Flux	1500lm	2	6.23	2.67	252		
Fixture Flux	1128lm	3	9.35	4.01	112		
Efficacy	81lm/W	4	12.47	5.35	63		
TS1082	I _{max} =774cd/klm	I _{max}	1161cd	5	15.59	6.69	40

Power Supply	Colour	2700K	3000K	3500K	4000K
500mA	●	1T6755	1T6756	1T6757	1T6758

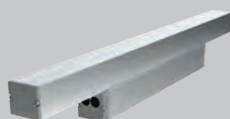

IP40 Integrated-removable driver L. 570mm

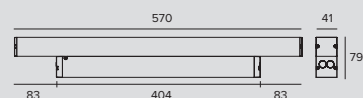

LED / 24W / FLOOD



		3000K	H(m)	D1(m)	D2(m)	E _{max} (lx)	
Ra90				85°	32°		
Fixture Power	28W	1	1.84	0.57	2099		
Source Flux	3000lm	2	3.68	1.14	525		
Fixture Flux	2242lm	3	5.52	1.70	233		
Efficacy	80lm/W	4	7.36	2.27	131		
TS1078	I _{max} =700cd/klm	I _{max}	2099cd	5	9.20	2.84	84

Driver	Colour	2700K	3000K	3500K	4000K
EL.	●	1T6759EL	1T6760EL	1T6761EL	1T6762EL
DALI	●	1T6759DA	1T6760DA	1T6761DA	1T6762DA

LED / 24W / GRAZING



		3000K	H(m)	D1(m)	D2(m)	E _{max} (lx)	
Ra90				76°	15°		
Fixture Power	28W	1	1.55	0.26	4805		
Source Flux	3000lm	2	3.10	0.51	1201		
Fixture Flux	2495lm	3	4.65	0.77	534		
Efficacy	89lm/W	4	6.21	1.02	300		
TS1080	Imax=1602cd/klm	Imax	4805cd	5	7.76	1.28	192

Driver	Colour	2700K	3000K	3500K	4000K
EL.	●	1T6763EL	1T6764EL	1T6765EL	1T6766EL
DALI	●	1T6763DA	1T6764DA	1T6765DA	1T6766DA

LED / 24W / WALL WASHER



		3000K	H(m)	D1(m)	D2(m)	E _{max} (lx)	
Ra90				115°	59°		
Fixture Power	28W	1	3.12	1.34	2017		
Source Flux	3000lm	2	6.23	2.67	504		
Fixture Flux	2256lm	3	9.35	4.01	224		
Efficacy	81lm/W	4	12.47	5.35	126		
TS1082	Imax=774cd/klm	Imax	2321cd	5	15.59	6.69	81

Driver	Colour	2700K	3000K	3500K	4000K
EL.	●	1T6767EL	1T6768EL	1T6769EL	1T6770EL
DALI	●	1T6767DA	1T6768DA	1T6769DA	1T6770DA



IP40
Integrated-removable
driver L. 850mm

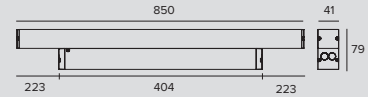

LED / 36W / FLOOD



		3000K	H(m)	D1(m)	D2(m)	E _{max} (lx)	
Ra90				85°	32°		
Fixture Power	40W	1	1.84	0.57	3146		
Source Flux	4500lm	2	3.68	1.14	787		
Fixture Flux	3361lm	3	5.52	1.70	350		
Efficacy	84lm/W	4	7.36	2.27	197		
TS1079	Imax=699cd/klm	Imax	3146cd	5	9.20	2.84	126

Driver	Colour	2700K	3000K	3500K	4000K
EL.	●	1T6771EL	1T6772EL	1T6773EL	1T6774EL
DALI	●	1T6771DA	1T6772DA	1T6773DA	1T6774DA

LED / 36W / GRAZING



		3000K	H(m)	D1(m)	D2(m)	E _{max} (lx)	
Ra90				76°	15°		
Fixture Power	40W	1	1.55	0.26	7203		
Source Flux	4500lm	2	3.10	0.51	1801		
Fixture Flux	3740lm	3	4.65	0.77	800		
Efficacy	94lm/W	4	6.21	1.02	450		
TS1081	Imax=1601cd/klm	Imax	7203cd	5	7.76	1.28	288

Driver	Colour	2700K	3000K	3500K	4000K
EL.	●	1T6775EL	1T6776EL	1T6777EL	1T6778EL
DALI	●	1T6775DA	1T6776DA	1T6777DA	1T6778DA

LED / 36W / WALL WASHER

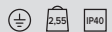

		3000K	H(m)	D1(m)	D2(m)	E _{max} (lx)	
Ra90				115°	59°		
Fixture Power	40W	1	3.12	1.34	3026		
Source Flux	4500lm	2	6.23	2.67	756		
Fixture Flux	3384lm	3	9.35	4.01	336		
Efficacy	85lm/W	4	12.47	5.35	189		
TS1083	Imax=774cd/klm	Imax	3482cd	5	15.59	6.69	121

Driver	Colour	2700K	3000K	3500K	4000K
EL.	●	1T6779EL	1T6780EL	1T6781EL	1T6782EL
DALI	●	1T6779DA	1T6780DA	1T6781DA	1T6782DA

JEDI COMPACT



IP40 Integrated-removable driver L. 1130mm

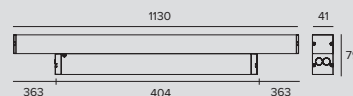

LED / 48W / FLOOD

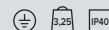

		3000K	H(m)	D1(m)	D2(m)	E _{max} (lx)	
Ra90				85°	32°		
Fixture Power	53W	1	1.84	0.57	4195		
Source Flux	6000lm	2	3.68	1.14	1049		
Fixture Flux	4482lm	3	5.52	1.70	466		
Efficacy	85lm/W	4	7.36	2.27	262		
TS1079	I _{max} =699cd/klm	I _{max}	4195cd	5	9.20	2.84	168

Driver	Colour	2700K	3000K	3500K	4000K
EL.	●	1T6783EL	1T6784EL	1T6785EL	1T6786EL
DALI	●	1T6783DA	1T6784DA	1T6785DA	1T6786DA

LED / 48W / GRAZING

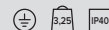

		3000K	H(m)	D1(m)	D2(m)	E _{max} (lx)	
Ra90				76°	15°		
Fixture Power	53W	1	1.55	0.26	9605		
Source Flux	6000lm	2	3.10	0.51	2401		
Fixture Flux	4987lm	3	4.65	0.77	1067		
Efficacy	94lm/W	4	6.21	1.02	600		
TS1081	I _{max} =1601cd/klm	I _{max}	9605cd	5	7.76	1.28	384

Driver	Colour	2700K	3000K	3500K	4000K
EL.	●	1T6787EL	1T6788EL	1T6789EL	1T6790EL
DALI	●	1T6787DA	1T6788DA	1T6789DA	1T6790DA

LED / 48W / WALL WASHER

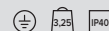

		3000K	H(m)	D1(m)	D2(m)	E _{max} (lx)	
Ra90				115°	59°		
Fixture Power	53W	1	3.12	1.34	4034		
Source Flux	6000lm	2	6.23	2.67	1009		
Fixture Flux	4512lm	3	9.35	4.01	448		
Efficacy	85lm/W	4	12.47	5.35	252		
TS1083	I _{max} =774cd/klm	I _{max}	4643cd	5	15.59	6.69	161

Driver	Colour	2700K	3000K	3500K	4000K
EL.	●	1T6791EL	1T6792EL	1T6793EL	1T6794EL
DALI	●	1T6791DA	1T6792DA	1T6793DA	1T6794DA

Related codes

Bracket

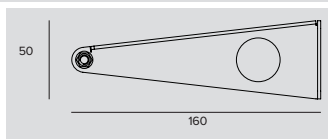

Code
1T6940

Long bracket kit for surface installation (2 pieces).
Rotation +/-145°.

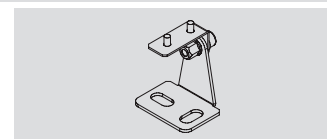

H Code
52 **1T6800**

Medium bracket kit for surface installation (2 pieces).
Integrated driver version.
Rotation +/-90°.

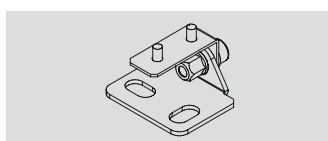

H Code
24 **1T6799**

Short bracket kit for surface installation (2 pieces).
Remote driver version.
Rotation +/-50°.

Power Supply

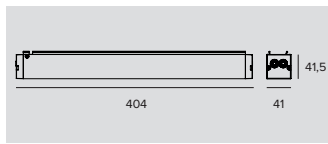

L	P	H	Driving current	Driver	Code
404	41	47	500mA	EL.	1T6797EL
404	41	47	500mA	EL.	1T6798EL
404	41	47	500mA	DALI	1T6797DA
404	41	47	500mA	DALI	1T6798DA

Driver box.

L. 289mm version.

1T6797EL - n° 1 JEDI COMPACT

1T6798EL - n° 2-4 JEDI COMPACT

1T6797DA - n° 1 JEDI COMPACT

1T6798DA - n° 2-4 JEDI COMPACT

Accessories

Grid

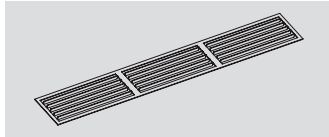

L	Code
278	1T6795

Symmetrical anti-glare grill.

For Flood and Grazing versions.

To be ordered in the following quantities for every fixture length: 1 for the 289mm version, 2 for the 570mm version, 3 for the 850mm version and 4 for the 1130mm version.

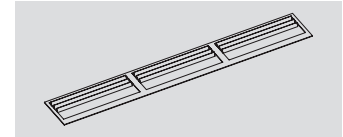

L	Code
278	1T6796

Asymmetrical anti-glare grill.

For Wall Washer versions.

To be ordered in the following quantities for every fixture length: 1 for the 289mm version, 2 for the 570mm version, 3 for the 850mm version and 4 for the 1130mm version.

Bracket

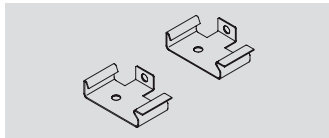

Code

1T6806

Bracket kit for surface installation of the driver box (2 pieces).

Snap brackets.

Control systems



Code

1T5349

Wireless control unit for DALI fixtures.

It generates a local DALI bus that can control individual fixtures.

The module can be connected to an existing DALI network.

The module is wireless controlled using a Casambi app for smartphones and tablets using Bluetooth 4.0 technology.

The devices create a wireless mesh network that can control up to 128 fixtures.

IP20.



Code

1T5352

IP20 Extender for wireless control of DALI fixtures.

It generates a local DALI bus with the capacity to drive up to 64 fixtures.

Can control DALI fixtures in indoor applications.

It is also equipped with a relay that can control non-dimmable fixtures up to a maximum of 6A.

ZENO

Wall mounted

GENERAL INFO

Asymmetric adjustable projector
MEDIUM Ø134mm
LARGE Ø184mm

LED

Chip on Board
From 2602lm to 5121lm
3000K - 4000K
Ra97

PRODUCT EFFICACY

Up to 54lm/W

OPTICS

WW

POWER SUPPLY

Electronic – DALI
Casambi control: the DALI version is fitted with special accessories.

MATERIAL

Die-cast painted aluminium optical unit and power supply box.

A range of professional projectors especially for museum lighting, given the quality of the LED sources, the cutting edge optics and installation flexibility.

The wall washer optics is particularly suitable for lighting vaulted ceilings.

The optical unit can be adjusted from 0 to -90° on the vertical plane; and 355° on the horizontal plane with aiming blocking system. Available in two different sizes.

Also available in the projector and recessed versions.





Merendoni Palace

Photographer
Ivan Rossi

Country
Bologna - Italy

ZENO

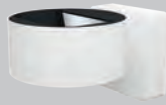

Applique Large

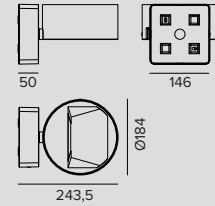

LED / 52W / WALL WASHER



	3000K		H(m)	D1(m)	D2(m)	E _{max} (lx)	
	Ra97			34°	81°		
Fixture Power	56W	1	0.98	1.99	1761		
Source Flux	4995lm	2	1.96	3.98	440		
Fixture Flux	2413lm	3	2.94	5.96	196		
Efficacy	43lm/W	4	3.92	7.95	110		
TS985	I _{max} =520cd/klm	I _{max}	2599cd	5	4.91	9.94	70

Driver	Colour	3000K	4000K
EL.	○	1T6313EL	1T6314EL
EL.	●	1T6315EL	1T6316EL
DALI	○	1T6313DA	1T6314DA
DALI	●	1T6315DA	1T6316DA

Accessories

Control systems



Code

1T5349

Wireless control unit for DALI fixtures.
It generates a local DALI bus that can control individual fixtures.
The module can be connected to an existing DALI network.
The module is wireless controlled using a Casambi app for smartphones and tablets using Bluetooth 4.0 technology.
The devices create a wireless mesh network that can control up to 128 fixtures.
IP20.



Code

1T5352

IP20 Extender for wireless control of DALI fixtures.
It generates a local DALI bus with the capacity to drive up to 64 fixtures.
Can control DALI fixtures in indoor applications.
It is also equipped with a relay that can control non-dimmable fixtures up to a maximum of 6A.



Applique Medium

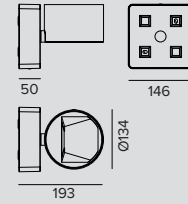

LED / 26W / WALL WASHER



	3000K	H(m)	D1(m)	D2(m)	E _{max} (lx)		
Ra97			34*	54*			
Fixture Power	28W	1	1.06	1.18	1345		
Source Flux	2602lm	2	2.11	2.35	336		
Fixture Flux	1473lm	3	3.17	3.53	149		
Efficacy	53lm/W	4	4.23	4.71	84		
TS979	Imax=745cd/klm	Imax	1939cd	5	5.28	5.89	54

Driver	Colour	3000K	4000K
EL.	○	1T6309EL	1T6310EL
EL.	●	1T6311EL	1T6312EL
DALI	○	1T6309DA	1T6310DA
DALI	●	1T6311DA	1T6312DA

Accessories

Control systems

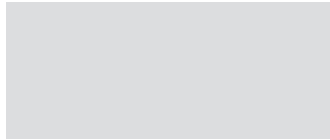

Code

1T5349

Wireless control unit for DALI fixtures.
It generates a local DALI bus that can control individual fixtures.
The module can be connected to an existing DALI network.
The module is wireless controlled using a Casambi app for smartphones and tablets using Bluetooth 4.0 technology.
The devices create a wireless mesh network that can control up to 128 fixtures.
IP20.

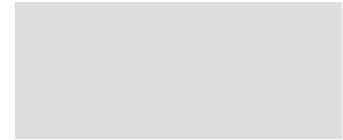

Code

1T5352

IP20 Extender for wireless control of DALI fixtures.
It generates a local DALI bus with the capacity to drive up to 64 fixtures.
Can control DALI fixtures in indoor applications.
It is also equipped with a relay that can control non-dimmable fixtures up to a maximum of 6A.

VOLTA

GENERAL INFO

Professional adjustable LED projector for wall or cornice installation.
184mmx86,5mm

LED

Elliptical and asymmetrical optic:
LED Chip on board
NSP optic: LED Emitter
From 650lm to 3187lm
3000K
Ra80 – Ra84

PRODUCT EFFICACY

Up to 110lm/W

OPTICS

NSP – ASYM – ELLIPTICAL

POWER SUPPLY

Electronic – DALI
Casambi control: the DALI version is fitted with special accessories.

MATERIAL

Body in extruded anodized aluminium, optic unit and terminal in die cast powder coated aluminium. Ultra flat protection screen in tempered glass. Bracket in stainless steel predisposed for surface installation.

Professional adjustable LED projector for wall or cornice installation, particularly suitable for lighting historical buildings of great artistic value.

It can be installed on cornices for lighting vaulted ceilings or pedestrian areas. Available in various colour variants that have been carefully studied to insert the fixture into historical architectural contexts.

All versions can be installed indoor as well as outdoor (IP66).

To be completed with remote driver.

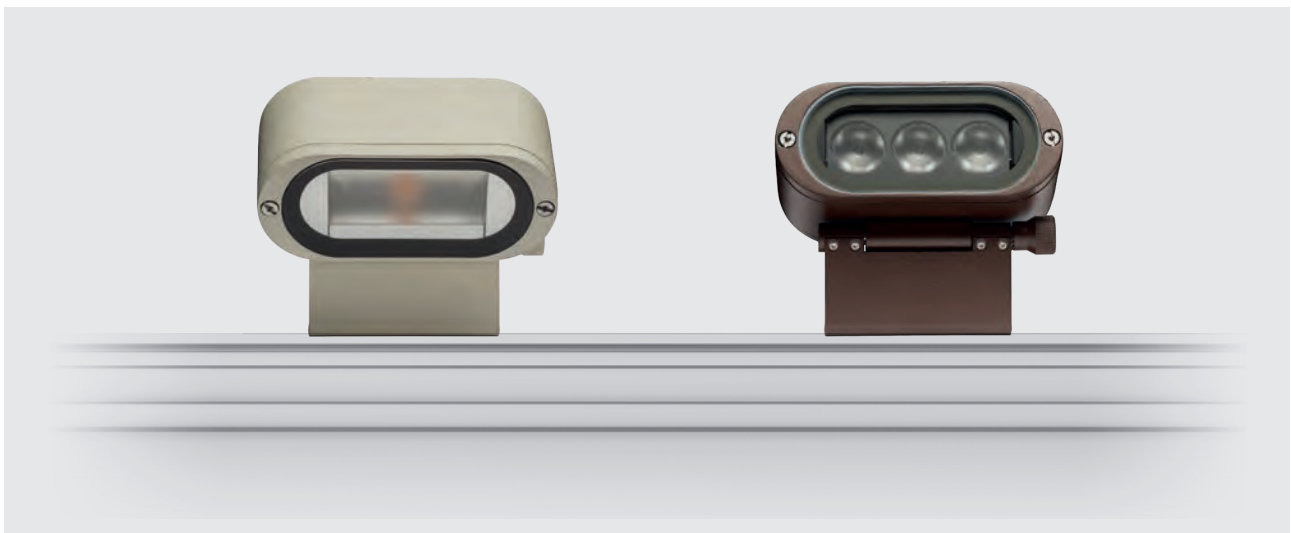



Merendoni Palace

Photographer
Ivan Rossi

Country
Bologna - Italy

VOLTA

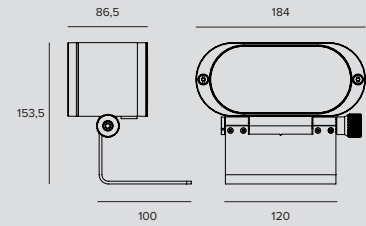

LED / 8W / NSP



		3000K	H(m)	D(m)	E _{max} (lx)	
		Ra80		9°		
Fixture Power	12W	1	0.16	13011		
Source Flux	650lm	2	0.32	3253		
Fixture Flux	544lm	3	0.48	1446		
Efficacy	47lm/W	4	0.64	813		
TS880	I _{max} =20017cd/klm	I _{max}	13011cd	5	0.80	520

Power supply	Colour	3000K
900mA		1T4632
900mA		1T4633
900mA		1E2565
900mA		1E2566

LED / 21/33W / ASYM



		3000K	H(m)	D1(m)	D2(m)	E _{max} (lx)	
		Ra84		61°	86°		
Fixture Power	24W	1	1.51	1.98	1356		
Source Flux	3187lm	2	3.01	3.96	339		
Fixture Flux	2304lm	3	4.52	5.94	151		
Efficacy	96lm/W	4	6.02	7.92	85		
TS881	I _{max} =464cd/klm	I _{max}	1480cd	5	7.53	9.89	54

Power supply	Colour	3000K
600/900mA		1T4634
600/900mA		1T4635
600/900mA		1E2567
600/900mA		1E2568

		3000K	H(m)	D1(m)	D2(m)	E _{max} (lx)	
		Ra84		61°	86°		
Fixture Power	37W	1	1.51	1.98	1860		
Source Flux	4373lm	2	3.01	3.96	465		
Fixture Flux	3162lm	3	4.52	5.94	207		
Efficacy	85lm/W	4	6.02	7.92	116		
TS881	I _{max} =464cd/klm	I _{max}	2031cd	5	7.53	9.89	74

LED / 21/33W / ELLIPTICAL



		3000K	H(m)	D1(m)	D2(m)	E _{max} (lx)	
		Ra84		42°	79°		
Fixture Power	24W	1	0.76	1.66	2266		
Source Flux	3187lm	2	1.52	3.31	567		
Fixture Flux	2530lm	3	2.28	4.97	252		
Efficacy	105lm/W	4	3.04	6.62	142		
TS882	I _{max} =711cd/klm	I _{max}	2266cd	5	3.80	8.28	91

Power supply	Colour	3000K
600/900mA		1T4636
600/900mA		1T4637
600/900mA		1E2569
600/900mA		1E2570

		3000K	H(m)	D1(m)	D2(m)	E _{max} (lx)	
		Ra84		42°	79°		
Fixture Power	37W	1	0.76	1.66	3110		
Source Flux	4373lm	2	1.52	3.31	777		
Fixture Flux	3471lm	3	2.28	4.97	346		
Efficacy	94lm/W	4	3.04	6.62	194		
TS882	I _{max} =711cd/klm	I _{max}	3110cd	5	3.80	8.28	124

Related codes

Power Supply

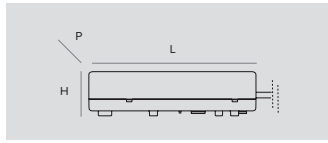

Code

32W - 110-240V, 600mA - IP20 - 160x35x83mm	1T3625
43W - 220-240V, 600mA - IP68 - 150x40x148mm	1E2571
50W - 220-240V, 900mA - IP20 - 160x35x83mm	1T2966
50W - 220-240V, 900mA - IP68 - 150x40x148mm	1E2573

Electronic power supply
LxHxP

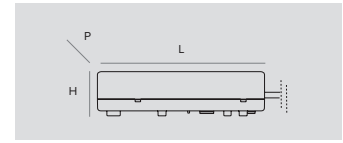

Code

32W - 110-240V, 600mA - IP20 - 160x35x83mm	1T3627
43W - 220-240V, 600mA - IP68 - 150x40x148mm	1E2572
50W - 110-240V, 900mA - IP20 - 160x35x83mm	1T2968
50W - 220-240V, 900mA - IP68 - 150x40x148mm	1E2574

DALI electronic power supply
LxHxP

Accessories

Filter

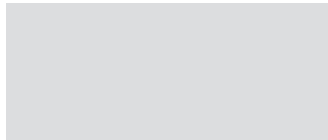

Colour	Code
	1T4638
	1T4639
	1E2575
	1E2576

Blade of light filter.
PMMA holographic filter for a blade of light effect, CNC machine anodised and powder coated aluminium frame.
For NSP optic.

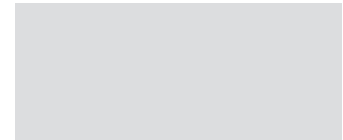

Colour	Code
	1T4640
	1T4641
	1E2577
	1E2578

Anti-glare.
PMMA holographic filter to reduce the beam angle, CNC machine anodised and powder coated aluminium frame.
NSP, ASYM, ELLIPTICAL

Screen

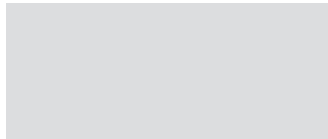

Colour	Code
	1T4642
	1T4643
	1E2579
	1E2580

Asymmetric screen.
Powder coated stainless steel.
NSP

Emergency Kit

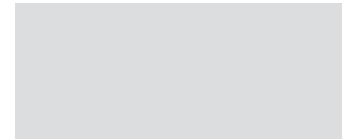
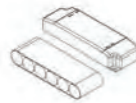

Code
1T3144

Emergency kit.
Inverter + 3h battery pack.
IP20.

Control systems



Code

1T5349

Wireless control unit for DALI fixtures.
It generates a local DALI bus that can control individual fixtures.
The module can be connected to an existing DALI network.
The module is wireless controlled using a Casambi app for smartphones and tablets using Bluetooth 4.0 technology.
The devices create a wireless mesh network that can control up to 128 fixtures.
IP20.



Code

1T5352

IP20 Extender for wireless control of DALI fixtures.
It generates a local DALI bus with the capacity to drive up to 64 fixtures.
Can control DALI fixtures in indoor applications.
It is also equipped with a relay that can control non-dimmable fixtures up to a maximum of 6A.



Code

1E3048

A IP67 Module for individual control of external devices equipped with DALI drivers.
The module needs to be positioned in order to receive radio signals.
The distance to the lighting fixtures can reach up to 50m.



Code

1E3049

IP67 Extender for wireless control of DALI fixtures.
It generates a local DALI bus with the capacity to drive up to 64 fixtures.
Can control DALI fixtures in outdoor applications.



Merendoni Palace

Photographer
Ivan Rossi

Country
Bologna - Italy

CORO

GENERAL INFO

Professional adjustable LED projector for wall or cornice installation.

Sistema de disipación pasiva. Posibilidad de orientación del cuerpo óptico de +/- 165° en plano horizontal y de +/-180° en plano vertical, con bloqueo. Ø82mm – Ø119mm

LED

Chip on board

From 200lm to 7130lm

3000K

Ra80 (only NSP optic) – Ra84 – Ra97

PRODUCT EFFICACY

Up to114lm/W

OPTICS

NSP (only Small version) – SP – FL

MWFL – WFL

DBS - Digital beam opening control

POWER SUPPLY

Electronic – DALI - Casambi on board

MATERIAL

CORO large: Body in die cast aluminium, front ring and joints in aluminium powder coated.

CORO Small: Body, front ring and joints in aluminium powder coated.

A range of cornice, capital and shelf projectors particularly suitable for installation in prestigious architectural environments where it is necessary to light the space without interfering with the architecture in any way.

Available in two different sizes - Large and Small - each with two different length arms and three different fixing systems that increase installation flexibility.

There is also a DBS - Dynamic Beam Shaper- version - for the Coro Large version only.

		CORO Large	CORO Small
		Ø 119mm	Ø 82mm
LED	Flux (lm)	2783-7130	200-2509
	Power	25W-55W	2.7W-18W

OPTICS

NSP	Lens		•
	Lens		•
SP	Hybrid	•	
	Reflector	•	•
FL	Lens		•
	Hybrid	•	
	Reflector	•	
MWFL	Reflector	•	
WFL	Reflector	•	
DBS	Variable	•	





Saint Germain des Prés

Lighting Design
Armand Zadkian

Photographer
Hugo Hebrard

Country
Paris - France

01

02

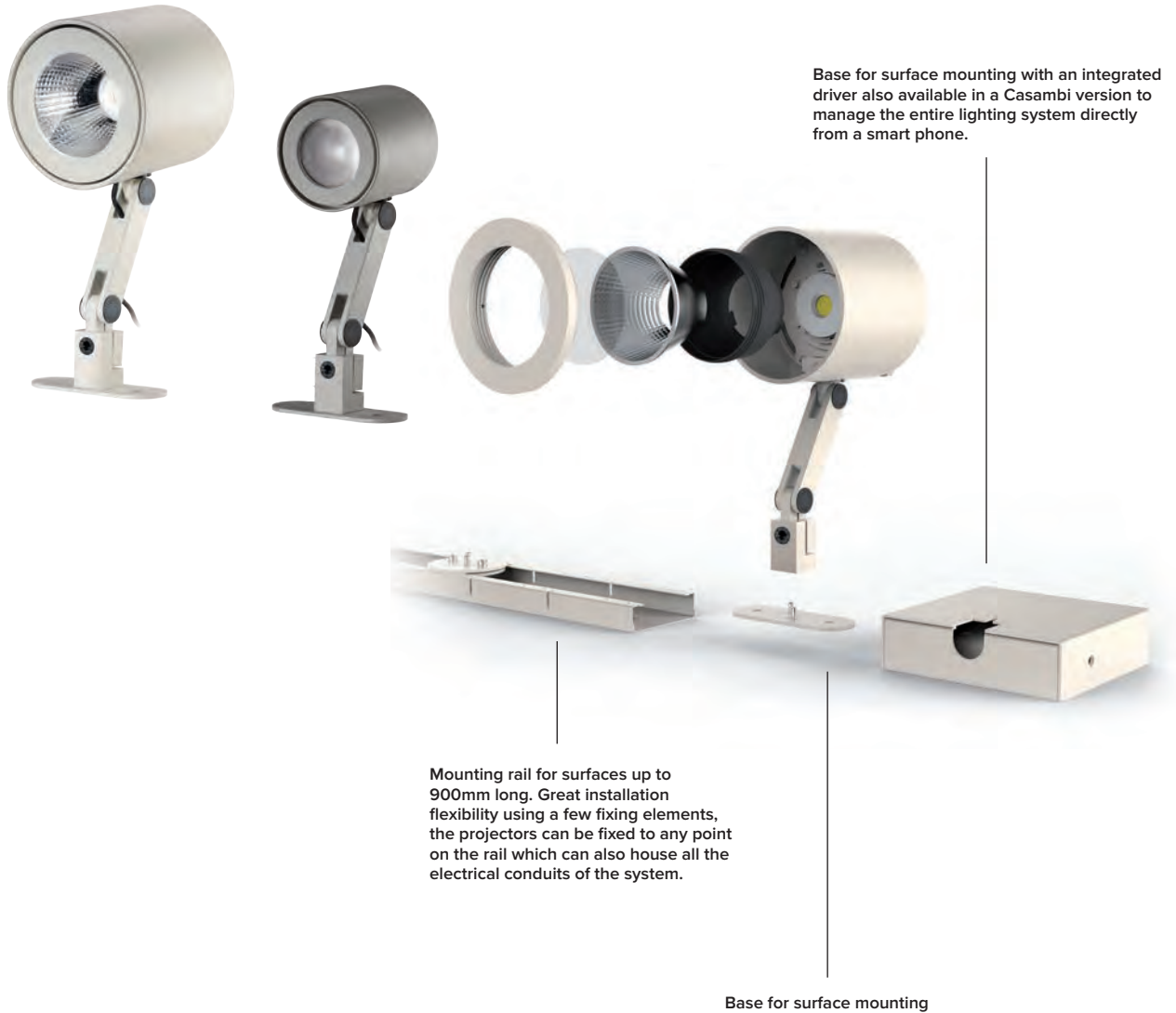

Base for surface mounting with an integrated driver also available in a Casambi version to manage the entire lighting system directly from a smart phone.

Mounting rail for surfaces up to 900mm long. Great installation flexibility using a few fixing elements, the projectors can be fixed to any point on the rail which can also house all the electrical conduits of the system.

Base for surface mounting

Coro available in two different sizes

and two different finishes: sandstone grey and Florentine white, two colours that integrate perfectly in historical contexts.

The flexibility of the fixture is best represented by its fixing system.

Three different solutions for as many types of installation.



Sala Zuccari

Palazzo Giustiniani

Photographer
Alessandro Maurelli

Country
Rome - Italy



Large long arm

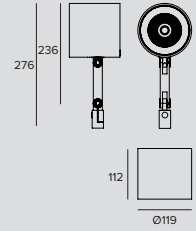

LED / 34W / HYBRID / SP / CRI84



	3000K	H(m)	D(m)	E _{max} (lx)		
	Ra84		13°			
	Fixture Power	37W	1	0.23	41198	
	Source Flux	4478lm	2	0.46	10299	
	Fixture Flux	2904lm	3	0.69	4578	
	Efficacy	78lm/W	4	0.92	2575	
TS918	I _{max} =9200cd/klm	I _{max}	41198cd	5	1.14	1648

Power supply	Colour	3000K
900mA		1T4785
900mA		1T4787

LED / 34W / HYBRID / SP / CRI97



	3000K	H(m)	D(m)	E _{max} (lx)		
	Ra97		13°			
	Fixture Power	37W	1	0.23	30351	
	Source Flux	3299lm	2	0.46	7588	
	Fixture Flux	2139lm	3	0.69	3372	
	Efficacy	58lm/W	4	0.92	1897	
TS918	I _{max} =9200cd/klm	I _{max}	30351cd	5	1.14	1214

Power supply	Colour	3000K
900mA		1T5312
900mA		1T5314

LED / 34W / HYBRID / FL / CRI84



	3000K	H(m)	D(m)	E _{max} (lx)		
	Ra84		33°			
	Fixture Power	37W	1	0.58	9994	
	Source Flux	4478lm	2	1.17	2499	
	Fixture Flux	2733lm	3	1.75	1110	
	Efficacy	73lm/W	4	2.33	625	
TS919	I _{max} =2232cd/klm	I _{max}	9994cd	5	2.92	400

Power supply	Colour	3000K
900mA		1T4786
900mA		1T4788

LED / 34W / HYBRID / FL / CRI97



	3000K	H(m)	D(m)	E _{max} (lx)		
	Ra97		33°			
	Fixture Power	37W	1	0.58	7363	
	Source Flux	3299lm	2	1.17	1841	
	Fixture Flux	2014lm	3	1.75	818	
	Efficacy	54lm/W	4	2.33	460	
TS919	I _{max} =2232cd/klm	I _{max}	7363cd	5	2.92	295

Power supply	Colour	3000K
900mA		1T5313
900mA		1T5315

LED / 25W / REFLECTOR / SP / CRI84



	3000K	H(m)	D(m)	E _{max} (lx)		
	Ra84		15°			
	Fixture Power	28W	1	0.26	24211	
	Source Flux	3617lm	2	0.52	6053	
	Fixture Flux	3074lm	3	0.78	2690	
	Efficacy	110lm/W	4	1.04	1513	
TS860	I _{max} =6694cd/klm	I _{max}	24211cd	5	1.30	968

Power supply	Colour	3000K
700mA		1T4560
700mA		1T4564

LED / 25W / REFLECTOR / SP / CRI97



		3000K	H(m)	D(m)	E _{max} (lx)
		Ra97		15°	
Fixture Power	28W	1	0.26	18629	
Source Flux	2783lm	2	0.52	4657	
Fixture Flux	2366lm	3	0.78	2070	
Efficacy	84lm/W	4	1.04	1164	
TS860	I _{max} =6694cd/klm	I _{max}	18629cd	5	1.30
					745

Power supply	Colour	3000K
700mA		1T5302
700mA		1T5306

LED / 25W / REFLECTOR / FL / CRI84



		3000K	H(m)	D(m)	E _{max} (lx)
		Ra84		31°	
Fixture Power	28W	1	0.55	9064	
Source Flux	3617lm	2	1.09	2266	
Fixture Flux	3062lm	3	1.64	1007	
Efficacy	109lm/W	4	2.19	567	
TS861	I _{max} =2506cd/klm	I _{max}	9064cd	5	2.73
					363

Power supply	Colour	3000K
700mA		1T4561
700mA		1T4565

LED / 25W / REFLECTOR / FL / CRI97



		3000K	H(m)	D(m)	E _{max} (lx)
		Ra97		31°	
Fixture Power	28W	1	0.55	6974	
Source Flux	2783lm	2	1.09	1744	
Fixture Flux	2356lm	3	1.64	775	
Efficacy	84lm/W	4	2.19	436	
TS861	I _{max} =2506cd/klm	I _{max}	6974cd	5	2.73
					279

Power supply	Colour	3000K
700mA		1T5303
700mA		1T5307

LED / 39W / REFLECTOR / SP / CRI84



		3000K	H(m)	D(m)	E _{max} (lx)
		Ra84		15°	
Fixture Power	42W	1	0.26	35380	
Source Flux	4980lm	2	0.51	8845	
Fixture Flux	4233lm	3	0.77	3931	
Efficacy	100lm/W	4	1.02	2211	
TS862	I _{max} =7104cd/klm	I _{max}	35380cd	5	1.28
					1415

Power supply	Colour	3000K
1050mA		1T4569
1050mA		1T4575

LED / 39W / REFLECTOR / SP / CRI97



		3000K	H(m)	D(m)	E _{max} (lx)
		Ra97		15°	
Fixture Power	42W	1	0.26	27210	
Source Flux	3830lm	2	0.51	6803	
Fixture Flux	3255lm	3	0.77	3023	
Efficacy	77lm/W	4	1.02	1701	
TS862	I _{max} =7104cd/klm	I _{max}	27210cd	5	1.28
					1088

Power supply	Colour	3000K
1050mA		1T4581
1050mA		1T4587

LED / 39W / REFLECTOR / FL / CRI84



		3000K	H(m)	D(m)	E _{max} (lx)
		Ra84		28°	
Fixture Power	42W	1	0.50	13841	
Source Flux	4980lm	2	1.01	3460	
Fixture Flux	4216lm	3	1.51	1538	
Efficacy	99lm/W	4	2.02	865	
TS863	I _{max} =2779cd/klm	I _{max}	13841cd	5	2.52
					554

Power supply	Colour	3000K
1050mA		1T4570
1050mA		1T4576

LED / 39W / REFLECTOR / FL / CR197



		3000K	H(m)	D(m)	E _{max} (lx)	
		Ra97		28°		
Fixture Power	42W	1	0.50	10645		
Source Flux	3830lm	2	1.01	2661		
Fixture Flux	3242lm	3	1.51	1183		
Efficacy	76lm/W	4	2.02	665		
TS863	I _{max} =2779cd/klm	I _{max}	10645cd	5	2.52	426

Power supply	Colour	3000K
1050mA		1T4582
1050mA		1T4588

LED / 39W / REFLECTOR / MWFL / CR184



		3000K	H(m)	D(m)	E _{max} (lx)	
		Ra84		43°		
Fixture Power	42W	1	0.79	8255		
Source Flux	4980lm	2	1.59	2064		
Fixture Flux	4328lm	3	2.38	917		
Efficacy	102lm/W	4	3.18	516		
TS864	I _{max} =1685cd/klm	I _{max}	8390cd	5	3.97	330

Power supply	Colour	3000K
1050mA		1T4571
1050mA		1T4577

LED / 39W / REFLECTOR / MWFL / CR197



		3000K	H(m)	D(m)	E _{max} (lx)	
		Ra97		43°		
Fixture Power	42W	1	0.79	6349		
Source Flux	3830lm	2	1.59	1587		
Fixture Flux	3328lm	3	2.38	705		
Efficacy	78lm/W	4	3.18	397		
TS864	I _{max} =1685cd/klm	I _{max}	6453cd	5	3.97	254

Power supply	Colour	3000K
1050mA		1T4583
1050mA		1T4589

LED / 45/55W / REFLECTOR / FL / CR184



		3000K	H(m)	D(m)	E _{max} (lx)	
		Ra84		34°		
Fixture Power	54W	1	0.62	15434		
Source Flux	7130lm	2	1.23	3858		
Fixture Flux	6035lm	3	1.85	1715		
Efficacy	113lm/W	4	2.46	965		
TS865	I _{max} =2165cd/klm	I _{max}	15434cd	5	3.08	617

Power supply	Colour	3000K
900/1050mA		1T4592
900/1050mA		1T4596

LED / 45/55W / REFLECTOR / FL / CR197



		3000K	H(m)	D(m)	E _{max} (lx)	
		Ra97		34°		
Fixture Power	54W	1	0.62	10446		
Source Flux	4826lm	2	1.23	2612		
Fixture Flux	4085lm	3	1.85	1161		
Efficacy	76lm/W	4	2.46	653		
TS865	I _{max} =2165cd/klm	I _{max}	10446cd	5	3.08	418

Power supply	Colour	3000K
900/1050mA		1T4600
900/1050mA		1T4604

LED / 45/55W / REFLECTOR / MWFL / CR184



		3000K	H(m)	D(m)	E _{max} (lx)	
		Ra84		47°		
Fixture Power	54W	1	0.87	10489		
Source Flux	7130lm	2	1.75	2622		
Fixture Flux	6196lm	3	2.62	1165		
Efficacy	116lm/W	4	3.50	656		
TS866	I _{max} =1472cd/klm	I _{max}	10496cd	5	4.37	420

Power supply	Colour	3000K
900/1050mA		1T4593
900/1050mA		1T4597

LED / 45/55W / REFLECTOR / MWFL / CRI97



		3000K	H(m)	D(m)	E _{max} (lx)	
		Ra97		47°		
Fixture Power	54W	1	0.87	7100		
Source Flux	4826lm	2	1.75	1775		
Fixture Flux	4194lm	3	2.62	789		
Efficacy	78lm/W	4	3.50	444		
TS866	I _{max} =1472cd/klm	I _{max}	7104cd	5	4.37	284

Power supply	Colour	3000K
900/1050mA		1T4601
900/1050mA		1T4605



Large short arm

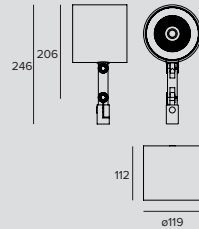

LED / 34W / HYBRID / SP / CRI84



		3000K	H(m)	D(m)	E _{max} (lx)	
		Ra84		13°		
Fixture Power	37W	1	0.23	41198		
Source Flux	4478lm	2	0.46	10299		
Fixture Flux	2904lm	3	0.69	4578		
Efficacy	78lm/W	4	0.92	2575		
TS918	I _{max} =9200cd/klm	I _{max}	41198cd	5	1.14	1648

Power supply	Colour	3000K
900mA		1T4781
900mA		1T4783

LED / 34W / HYBRID / SP / CRI97



		3000K	H(m)	D(m)	E _{max} (lx)	
		Ra97		13°		
Fixture Power	37W	1	0.23	30351		
Source Flux	3299lm	2	0.46	7588		
Fixture Flux	2139lm	3	0.69	3372		
Efficacy	58lm/W	4	0.92	1897		
TS918	I _{max} =9200cd/klm	I _{max}	30351cd	5	1.14	1214

Power supply	Colour	3000K
900mA		1T5308
900mA		1T5310

LED / 34W / HYBRID / FL / CRI84



		3000K	H(m)	D(m)	E _{max} (lx)	
		Ra84		33°		
Fixture Power	37W	1	0.58	9994		
Source Flux	4478lm	2	1.17	2499		
Fixture Flux	2733lm	3	1.75	1110		
Efficacy	73lm/W	4	2.33	625		
TS919	I _{max} =2232cd/klm	I _{max}	9994cd	5	2.92	400

Power supply	Colour	3000K
900mA		1T4782
900mA		1T4784

LED / 34W / HYBRID / FL / CRI97



		3000K	H(m)	D(m)	E _{max} (lx)	
		Ra97		33°		
Fixture Power	37W	1	0.58	7363		
Source Flux	3299lm	2	1.17	1841		
Fixture Flux	2014lm	3	1.75	818		
Efficacy	54lm/W	4	2.33	460		
TS919	I _{max} =2232cd/klm	I _{max}	7363cd	5	2.92	295

Power supply	Colour	3000K
900mA		1T5309
900mA		1T5311

LED / 25W / REFLECTOR / SP / CRI84



		3000K	H(m)	D(m)	E _{max} (lx)
		Ra84		15°	
Fixture Power	28W	1	0.26	24211	
Source Flux	3617lm	2	0.52	6053	
Fixture Flux	3074lm	3	0.78	2690	
Efficacy	110lm/W	4	1.04	1513	
TS860	I _{max} =6694cd/klm	I _{max}	24211cd	5	1.30

Power supply	Colour	3000K
700mA		1T4558
700mA		1T4562

LED / 25W / REFLECTOR / SP / CRI97



		3000K	H(m)	D(m)	E _{max} (lx)
		Ra97		15°	
Fixture Power	28W	1	0.26	18629	
Source Flux	2783lm	2	0.52	4657	
Fixture Flux	2366lm	3	0.78	2070	
Efficacy	84lm/W	4	1.04	1164	
TS860	I _{max} =6694cd/klm	I _{max}	18629cd	5	1.30

Power supply	Colour	3000K
700mA		1T5300
700mA		1T5304

LED / 25W / REFLECTOR / FL / CRI84



		3000K	H(m)	D(m)	E _{max} (lx)
		Ra84		31°	
Fixture Power	28W	1	0.55	9064	
Source Flux	3617lm	2	1.09	2266	
Fixture Flux	3062lm	3	1.64	1007	
Efficacy	109lm/W	4	2.19	567	
TS861	I _{max} =2506cd/klm	I _{max}	9064cd	5	2.73

Power supply	Colour	3000K
700mA		1T4559
700mA		1T4563

LED / 25W / REFLECTOR / FL / CRI97



		3000K	H(m)	D(m)	E _{max} (lx)
		Ra97		31°	
Fixture Power	28W	1	0.55	6974	
Source Flux	2783lm	2	1.09	1744	
Fixture Flux	2356lm	3	1.64	775	
Efficacy	84lm/W	4	2.19	436	
TS861	I _{max} =2506cd/klm	I _{max}	6974cd	5	2.73

Power supply	Colour	3000K
700mA		1T5301
700mA		1T5305

LED / 39W / REFLECTOR / SP / CRI84



		3000K	H(m)	D(m)	E _{max} (lx)
		Ra84		15°	
Fixture Power	42W	1	0.26	35380	
Source Flux	4980lm	2	0.51	8845	
Fixture Flux	4233lm	3	0.77	3931	
Efficacy	100lm/W	4	1.02	2211	
TS862	I _{max} =7104cd/klm	I _{max}	35380cd	5	1.28

Power supply	Colour	3000K
1050mA		1T4566
1050mA		1T4572

LED / 39W / REFLECTOR / SP / CRI97



		3000K	H(m)	D(m)	E _{max} (lx)
		Ra97		15°	
Fixture Power	42W	1	0.26	27210	
Source Flux	3830lm	2	0.51	6803	
Fixture Flux	3255lm	3	0.77	3023	
Efficacy	77lm/W	4	1.02	1701	
TS862	I _{max} =7104cd/klm	I _{max}	27210cd	5	1.28

Power supply	Colour	3000K
1050mA		1T4578
1050mA		1T4584

LED / 39W / REFLECTOR / FL / CR184



		3000K	H(m)	D(m)	E _{max} (lx)
		Ra84		28°	
Fixture Power	42W	1	0.50	13841	
Source Flux	4980lm	2	1.01	3460	
Fixture Flux	4216lm	3	1.51	1538	
Efficacy	99lm/W	4	2.02	865	
TS863	I _{max} =2779cd/klm	I _{max}	13841cd	5	2.52

Power supply	Colour	3000K
1050mA		1T4567
1050mA		1T4573

LED / 39W / REFLECTOR / FL / CR197



		3000K	H(m)	D(m)	E _{max} (lx)
		Ra97		28°	
Fixture Power	42W	1	0.50	10645	
Source Flux	3830lm	2	1.01	2661	
Fixture Flux	3242lm	3	1.51	1183	
Efficacy	76lm/W	4	2.02	665	
TS863	I _{max} =2779cd/klm	I _{max}	10645cd	5	2.52

Power supply	Colour	3000K
1050mA		1T4579
1050mA		1T4585

LED / 39W / REFLECTOR / MWFL / CR184



		3000K	H(m)	D(m)	E _{max} (lx)
		Ra84		43°	
Fixture Power	42W	1	0.79	8255	
Source Flux	4980lm	2	1.59	2064	
Fixture Flux	4328lm	3	2.38	917	
Efficacy	102lm/W	4	3.18	516	
TS864	I _{max} =1685cd/klm	I _{max}	8390cd	5	3.97

Power supply	Colour	3000K
1050mA		1T4568
1050mA		1T4574

LED / 39W / REFLECTOR / MWFL / CR197



		3000K	H(m)	D(m)	E _{max} (lx)
		Ra97		43°	
Fixture Power	42W	1	0.79	6349	
Source Flux	3830lm	2	1.59	1587	
Fixture Flux	3328lm	3	2.38	705	
Efficacy	78lm/W	4	3.18	397	
TS864	I _{max} =1685cd/klm	I _{max}	6453cd	5	3.97

Power supply	Colour	3000K
1050mA		1T4580
1050mA		1T4586

LED / 45/55W / REFLECTOR / FL / CR184



		3000K	H(m)	D(m)	E _{max} (lx)
		Ra84		34°	
Fixture Power	54W	1	0.62	15434	
Source Flux	7130lm	2	1.23	3858	
Fixture Flux	6035lm	3	1.85	1715	
Efficacy	113lm/W	4	2.46	965	
TS865	I _{max} =2165cd/klm	I _{max}	15434cd	5	3.08

Power supply	Colour	3000K
900/1050mA		1T4590
900/1050mA		1T4594

LED / 45/55W / REFLECTOR / FL / CR197



		3000K	H(m)	D(m)	E _{max} (lx)
		Ra97		34°	
Fixture Power	54W	1	0.62	10446	
Source Flux	4826lm	2	1.23	2612	
Fixture Flux	4085lm	3	1.85	1161	
Efficacy	76lm/W	4	2.46	653	
TS865	I _{max} =2165cd/klm	I _{max}	10446cd	5	3.08

Power supply	Colour	3000K
900/1050mA		1T4598
900/1050mA		1T4602

CORO

LED / 45/55W / REFLECTOR / MWFL / CRI84



	3000K	H(m)	D(m)	E _{max} (lx)
	Ra84		47°	
Fixture Power	54W	1	0.87	10489
Source Flux	7130lm	2	1.75	2622
Fixture Flux	6196lm	3	2.62	1165
Efficacy	116lm/W	4	3.50	656
TS866	I _{max} =1472cd/klm	I _{max}	10496cd	5 4.37 420

Power supply	Colour	3000K
900/1050mA		1T4591
900/1050mA		1T4595

LED / 45/55W / REFLECTOR / MWFL / CRI97



	3000K	H(m)	D(m)	E _{max} (lx)
	Ra97		47°	
Fixture Power	54W	1	0.87	7100
Source Flux	4826lm	2	1.75	1775
Fixture Flux	4194lm	3	2.62	789
Efficacy	78lm/W	4	3.50	444
TS866	I _{max} =1472cd/klm	I _{max}	7104cd	5 4.37 284

Power supply	Colour	3000K
900/1050mA		1T4599
900/1050mA		1T4603



Large DBS long arm

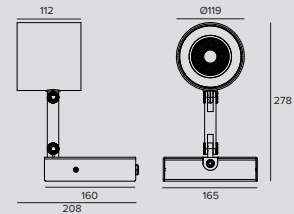

LED / 34W / DBS / CRI84



	3000K	H(m)	D(m)	E _{max} (lx)
	Ra84		14°	
Fixture Power	37W	1	0.25	25176
Source Flux	4478lm	2	0.50	6294
Fixture Flux	2140lm	3	0.75	2797
Efficacy	58lm/W	4	1.00	1573
TS1110	I _{max} =5622cd/klm	I _{max}	25176cd	5 1.26 1007

Driver	Colour	3000K
CASAMBI		1T6945CA
CASAMBI		1T6946CA

	3000K	H(m)	D(m)	E _{max} (lx)
	Ra84		24°	
Fixture Power	37W	1	0.43	8931
Source Flux	4478lm	2	0.86	2233
Fixture Flux	2082lm	3	1.29	992
Efficacy	56lm/W	4	1.72	558
TS1111	I _{max} =1994cd/klm	I _{max}	8931cd	5 2.15 357

	3000K	H(m)	D(m)	E _{max} (lx)
	Ra84		45°	
Fixture Power	37W	1	0.83	2585
Source Flux	4478lm	2	1.67	646
Fixture Flux	1769lm	3	2.50	287
Efficacy	48lm/W	4	3.34	162
TS1113	I _{max} =577cd/klm	I _{max}	2585cd	5 4.17 103

	3000K	H(m)	D(m)	E _{max} (lx)
	Ra84		31°	
Fixture Power	37W	1	0.56	5426
Source Flux	4478lm	2	1.13	1356
Fixture Flux	2016lm	3	1.69	603
Efficacy	54lm/W	4	2.25	339
TS1112	I _{max} =1212cd/klm	I _{max}	5426cd	5 2.82 217

LED / 34W / DBS / CRI97



	3000K	H(m)	D(m)	Emax(lx)		
	Ra97		14°			
	Fixture Power	37W	1	0.25	18547	
	Source Flux	3299lm	2	0.50	4637	
	Fixture Flux	1577lm	3	0.75	2061	
	Efficacy	42lm/W	4	1.00	1159	
TS1110	Imax=5622cd/klm	Imax	18547cd	5	1.26	742

	3000K	H(m)	D(m)	Emax(lx)		
	Ra97		24°			
	Fixture Power	37W	1	0.43	6580	
	Source Flux	3299lm	2	0.86	1645	
	Fixture Flux	1534lm	3	1.29	731	
	Efficacy	41lm/W	4	1.72	411	
TS1111	Imax=1994cd/klm	Imax	6580cd	5	2.15	263

	3000K	H(m)	D(m)	Emax(lx)		
	Ra97		45°			
	Fixture Power	37W	1	0.83	1904	
	Source Flux	3299lm	2	1.67	476	
	Fixture Flux	1303lm	3	2.50	212	
	Efficacy	35lm/W	4	3.34	119	
TS1113	Imax=577cd/klm	Imax	1904cd	5	4.17	76

	3000K	H(m)	D(m)	Emax(lx)		
	Ra97		31°			
	Fixture Power	37W	1	0.56	3997	
	Source Flux	3299lm	2	1.13	999	
	Fixture Flux	1485lm	3	1.69	444	
	Efficacy	40lm/W	4	2.25	250	
TS1112	Imax=1212cd/klm	Imax	3997cd	5	2.82	160

Driver	Colour	4000K
CASAMBI		1T6947CA
CASAMBI		1T6948CA

Related codes

Mounting System

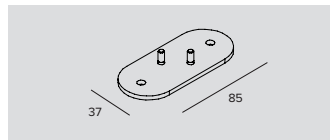

Colour	Code
	1T4606
	1T4607

White surface mounting base.

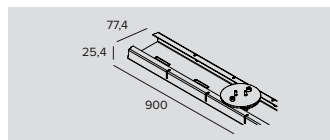

Colour	Code
	1T4628
	1T4629

Surface mounting channel 900mm.
The channel can be cut to length at intervals of 10cm.
With three mounting bases for Coro "Small" and "Big".

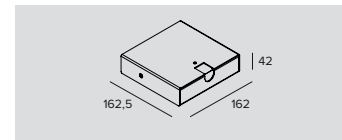

Power supply	Driving current	Driver	Colour	Code
220-240Vac 50/60Hz	700mA	EL.		1T4612
220-240Vac 50/60Hz	700mA	DALI		1T4613
220-240Vac 50/60Hz	700mA	DALI (CASAMBI)		1T4613CA
220-240Vac 50/60Hz	900mA	EL.		1T4614
220-240Vac 50/60Hz	900mA	DALI		1T4615
220-240Vac 50/60Hz	900mA	DALI (CASAMBI)		1T4615CA
220-240Vac 50/60Hz	1050mA max 60W	EL.		1T4616
220-240Vac 50/60Hz	1050mA max 60W	DALI		1T4617
220-240Vac 50/60Hz	1050mA max 60W	DALI (CASAMBI)		1T4617CA
220-240Vac 50/60Hz	700mA	EL.		1T4622
220-240Vac 50/60Hz	700mA	DALI		1T4623
220-240Vac 50/60Hz	700mA	DALI (CASAMBI)		1T4623CA
220-240Vac 50/60Hz	900mA	EL.		1T4624
220-240Vac 50/60Hz	900mA	DALI		1T4625
220-240Vac 50/60Hz	900mA	DALI (CASAMBI)		1T4625CA
220-240Vac 50/60Hz	1050mA max 60W	EL.		1T4626
220-240Vac 50/60Hz	1050mA max 60W	DALI		1T4627
220-240Vac 50/60Hz	1050mA max 60W	DALI (CASAMBI)		1T4627CA

Surface mounting base with integrated driver.

CORO

Power Supply

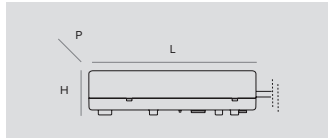

	Code
29W - 110-240V, 700mA - IP20 - 160x35x83mm	1T2963
50W - 220-240V, 900mA - IP20 - 160x35x83mm	1T2966
42W - 110-240V, 1050mA - IP20 - 160x35x83mm	1T3781
60W - 220-240V, 1050mA - IP20 - 129x30x76mm	1T4723
Electronic power supply LxHxP	

	Code
29W - 110-240V, 700mA - IP20 - 160x35x83mm	1T2965
50W - 110-240V, 900mA - IP20 - 160x35x83mm	1T2968
42W - 110-240V, 1050mA - IP20 - 160x35x83mm	1T3783
60W - 220-240V, 1050mA - IP20 - 129x30x76mm	1T4725
DALI electronic power supply LxHxP	

Accessories

Filter

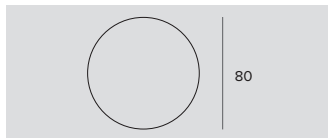

Filter	Ø	Code
Red	80	1T3424
Green	80	1T3425
Blue	80	1T3426
Yellow	80	1T3427
Magenta	80	1T3428

Flat glass interference chromatic filter.

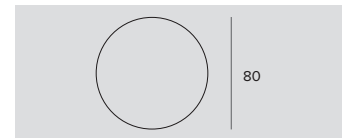

	Ø	Code
	80	1T3141

Flat glass, grooved refractive blade light filter.

This makes the beam take on an oval shape and when combined with spotlights, the light blade appears more prominent.

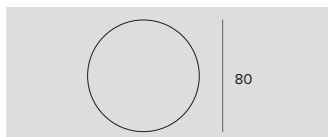

	Ø	Code
	80	1T3140

Flat glass micro prismatic refractive diffusive filter.
This softens the luminous effect.

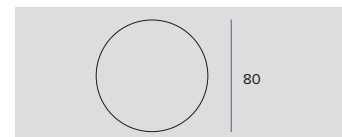

Filter	Ø	Code
Halogen +	80	1T6382
Vivid +	80	1T6384

Art filter.

Flat glass interference filter that can vary the colour parameters of the emission of the fixtures it is applied to.
To be used only with 3000K and Ra80 fixtures.

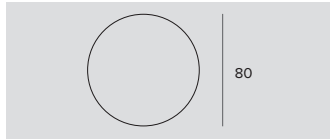

Filter	Ø	Code
Meat	80	1T6386
Fish	80	1T6388
Bread	80	1T6390
Vegetables	80	1T6392

Food filter.

Flat glass interference filter that can vary the colour parameters of the emission of the fixtures it is applied to.

1T6386

To be used only with 3000K and Ra80 fixtures.

1T6388

To be used only with 4000K and Ra80 fixtures.

1T6390

To be used only with 3000K and Ra80 fixtures.

1T6392

To be used only with 3000K and Ra80 fixtures.

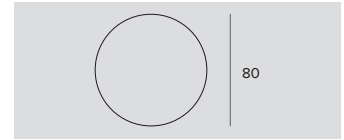

Filter	Ø	Code
Beauty	80	1T6394

Beauty filter.

Flat glass interference filter that can vary the colour parameters of the emission of the fixtures it is applied to.

To be used only with 3000K and Ra80 fixtures.

Grid

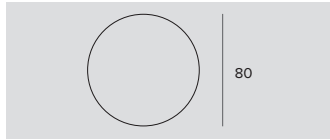

Ø	Code
80	1T3423

Anti-glare louver.

Black painted metal honeycomb structure.

Zoom

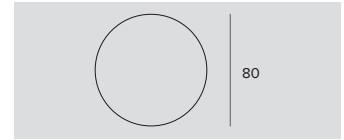

Ø	Code
80	1T3432

Zoom.

Optical system consists of an optical glass flat convex lens, an anodized aluminium specular reflector and a diffusive holographic filter.

To be used after removing the existing optic.

It makes it possible to obtain a variable beam from 15° to 60°.

It can not be used with NSP and hybrid optics; no for DBS version.

Cut-off

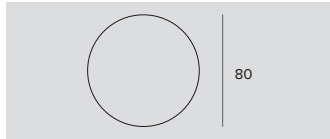

Ø	Code
80	1T3142

Cut-off Tube.

Allows for the beam to be focused while removing the fall-off component.

No for DBS version.

Screen

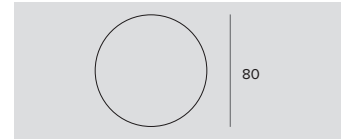

Ø	Code
80	1T3143

Black painted anodized diffusive aluminium asymmetric screen.

Complete with blade light filter.

Ideal for a Wall Washer effect.

To be combined with spot and flood optics.

CORO

Emergency Kit

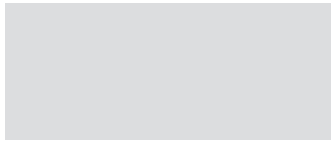
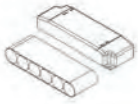

Code

1T3144

Emergency kit.
Inverter + 3h battery pack.
IP20.

Control systems

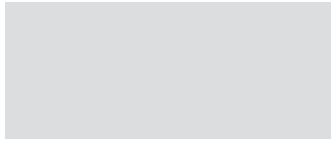

Code

1T5349

Wireless control unit for DALI fixtures.
It generates a local DALI bus that can control individual fixtures.
The module can be connected to an existing DALI network.
The module is wireless controlled using a Casambi app for smartphones and tablets using Bluetooth 4.0 technology.
The devices create a wireless mesh network that can control up to 128 fixtures.
IP20.

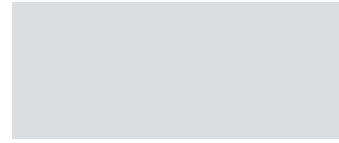

Code

1T5352

IP20 Extender for wireless control of DALI fixtures.
It generates a local DALI bus with the capacity to drive up to 64 fixtures.
Can control DALI fixtures in indoor applications.
It is also equipped with a relay that can control non-dimmable fixtures up to a maximum of 6A.



Small long arm

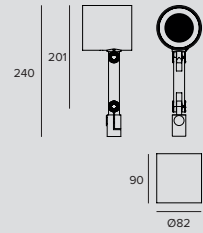

LED / 2,7W / LENS / NSP / CRI80



		3000K	H(m)	D(m)	Emax(lx)	
Ra80				9°		
Fixture Power	5W	1	0.15	4436		
Source Flux	200lm	2	0.30	1109		
Fixture Flux	163lm	3	0.45	493		
Efficacy	31lm/W	4	0.60	277		
TS890	Imax=22178cd/klm	Imax	4436cd	5	0.75	177

Power supply	Colour	3000K
900mA		1T4724
900mA		1T4728

LED / 11W / LENS / SP / CRI84



		3000K	H(m)	D(m)	Emax(lx)	
Ra84				15°		
Fixture Power	14W	1	0.27	15975		
Source Flux	1686lm	2	0.53	3994		
Fixture Flux	1261lm	3	0.80	1775		
Efficacy	93lm/W	4	1.07	998		
TS855	Imax=9475cd/klm	Imax	15975cd	5	1.33	639

Power supply	Colour	3000K
350mA		1T4528
350mA		1T4532

LED / 12W / LENS / FL / CRI84



		3000K	H(m)	D(m)	Emax(lx)	
Ra84				30°		
Fixture Power	14W	1	0.54	4873		
Source Flux	1856lm	2	1.09	1218		
Fixture Flux	1328lm	3	1.63	541		
Efficacy	98lm/W	4	2.17	305		
TS856	Imax=2625cd/klm	Imax	4873cd	5	2.72	195

Power supply	Colour	3000K
350mA		1T4529
350mA		1T4533

LED / 18W / LENS / SP / CRI84



		3000K	H(m)	D(m)	Emax(lx)	
Ra84				24°		
Fixture Power	20W	1	0.43	8958		
Source Flux	2509lm	2	0.87	2239		
Fixture Flux	1831lm	3	1.30	995		
Efficacy	91lm/W	4	1.73	560		
TS857	Imax=3570cd/klm	Imax	8958cd	5	2.17	358

Power supply	Colour	3000K
500mA		1T4541
500mA		1T4547

LED / 18W / LENS / SP / CRI97



		3000K	H(m)	D(m)	Emax(lx)	
Ra97				24°		
Fixture Power	20W	1	0.43	6869		
Source Flux	1924lm	2	0.87	1717		
Fixture Flux	1404lm	3	1.30	763		
Efficacy	69lm/W	4	1.73	429		
TS857	Imax=3570cd/klm	Imax	6869cd	5	2.17	275

Power supply	Colour	3000K
500mA		1T5298
500mA		1T5299

CORO

LED / 18W / REFLECTOR / MWFL / CRI84



		3000K	H(m)	D(m)	E _{max} (lx)	
		Ra84		48°		
Fixture Power	20W	1	0.90	3229		
Source Flux	2509lm	2	1.80	807		
Fixture Flux	1983lm	3	2.69	359		
Efficacy	98lm/W	4	3.59	202		
TS858	I _{max} =1310cd/klm	I _{max}	3287cd	5	4.49	129

Power supply	Colour	3000K
500mA		1T4542
500mA		1T4548

LED / 18W / REFLECTOR / MWFL / CRI97



		3000K	H(m)	D(m)	E _{max} (lx)	
		Ra97		48°		
Fixture Power	20W	1	0.90	2476		
Source Flux	1924lm	2	1.80	619		
Fixture Flux	1520lm	3	2.69	275		
Efficacy	75lm/W	4	3.59	155		
TS858	I _{max} =1310cd/klm	I _{max}	2521cd	5	4.49	99

Power supply	Colour	3000K
500mA		1T4552
500mA		1T4556

LED / 18W / REFLECTOR / WFL / CRI84



		3000K	H(m)	D(m)	E _{max} (lx)	
		Ra84		60°		
Fixture Power	20W	1	1.16	2447		
Source Flux	2509lm	2	2.32	612		
Fixture Flux	2013lm	3	3.47	272		
Efficacy	100lm/W	4	4.63	153		
TS859	I _{max} =976cd/klm	I _{max}	2449cd	5	5.79	98

Power supply	Colour	3000K
500mA		1T4543
500mA		1T4549

LED / 18W / REFLECTOR / WFL / CRI97



		3000K	H(m)	D(m)	E _{max} (lx)	
		Ra97		60°		
Fixture Power	20W	1	1.16	1877		
Source Flux	1924lm	2	2.32	469		
Fixture Flux	1544lm	3	3.47	209		
Efficacy	76lm/W	4	4.63	117		
TS859	I _{max} =976cd/klm	I _{max}	1878cd	5	5.79	75

Power supply	Colour	3000K
500mA		1T4553
500mA		1T4557



Small short arm

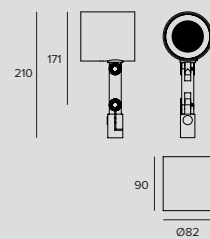

LED / 2,7W / LENS / NSP / CRI80

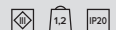

		3000K	H(m)	D(m)	E _{max} (lx)	
		Ra80		9°		
Fixture Power	5W	1	0.15	4436		
Source Flux	200lm	2	0.30	1109		
Fixture Flux	163lm	3	0.45	493		
Efficacy	31lm/W	4	0.60	277		
TS890	I _{max} =22178cd/klm	I _{max}	4436cd	5	0.75	177

Power supply	Colour	3000K
900mA		1T4722
900mA		1T4726

LED / 11W / LENS / SP / CRI84



		3000K	H(m)	D(m)	E _{max} (lx)	
		Ra84		15°		
Fixture Power	14W	1	0.27	15975		
Source Flux	1686lm	2	0.53	3994		
Fixture Flux	1261lm	3	0.80	1775		
Efficacy	93lm/W	4	1.07	998		
TS855	I _{max} =9475cd/klm	I _{max}	15975cd	5	1.33	639

Power supply	Colour	3000K
350mA		1T4526
350mA		1T4530

LED / 12W / LENS / FL / CRI84



		3000K	H(m)	D(m)	E _{max} (lx)	
		Ra84		30°		
Fixture Power	14W	1	0.54	4873		
Source Flux	1856lm	2	1.09	1218		
Fixture Flux	1328lm	3	1.63	541		
Efficacy	98lm/W	4	2.17	305		
TS856	I _{max} =2625cd/klm	I _{max}	4873cd	5	2.72	195

Power supply	Colour	3000K
350mA		1T4527
350mA		1T4531

LED / 18W / LENS / SP / CRI84



		3000K	H(m)	D(m)	E _{max} (lx)	
		Ra84		24°		
Fixture Power	20W	1	0.43	8958		
Source Flux	2509lm	2	0.87	2239		
Fixture Flux	1831lm	3	1.30	995		
Efficacy	91lm/W	4	1.73	560		
TS857	I _{max} =3570cd/klm	I _{max}	8958cd	5	2.17	358

Power supply	Colour	3000K
500mA		1T4538
500mA		1T4544

LED / 18W / LENS / SP / CRI97



		3000K	H(m)	D(m)	E _{max} (lx)	
		Ra97		24°		
Fixture Power	20W	1	0.43	6869		
Source Flux	1924lm	2	0.87	1717		
Fixture Flux	1404lm	3	1.30	763		
Efficacy	69lm/W	4	1.73	429		
TS857	I _{max} =3570cd/klm	I _{max}	6869cd	5	2.17	275

Power supply	Colour	3000K
500mA		1T5296
500mA		1T5297

LED / 18W / REFLECTOR / MWFL / CRI84



		3000K	H(m)	D(m)	E _{max} (lx)	
		Ra84		48°		
Fixture Power	20W	1	0.90	3229		
Source Flux	2509lm	2	1.80	807		
Fixture Flux	1983lm	3	2.69	359		
Efficacy	98lm/W	4	3.59	202		
TS858	I _{max} =1310cd/klm	I _{max}	3287cd	5	4.49	129

Power supply	Colour	3000K
500mA		1T4539
500mA		1T4545

LED / 18W / REFLECTOR / MWFL / CRI97



		3000K	H(m)	D(m)	E _{max} (lx)	
		Ra97		48°		
Fixture Power	20W	1	0.90	2476		
Source Flux	1924lm	2	1.80	619		
Fixture Flux	1520lm	3	2.69	275		
Efficacy	75lm/W	4	3.59	155		
TS858	I _{max} =1310cd/klm	I _{max}	2521cd	5	4.49	99

Power supply	Colour	3000K
500mA		1T4550
500mA		1T4554

CORO

LED / 18W / REFLECTOR / WFL / CRI84



	3000K	H(m)	D(m)	Emax(lx)		
	Ra84		60°			
	Fixture Power	20W	1	1.16	2447	
	Source Flux	2509lm	2	2.32	612	
	Fixture Flux	2013lm	3	3.47	272	
	Efficacy	100lm/W	4	4.63	153	
TS859	I _{max} =976cd/klm	I _{max}	2449cd	5	5.79	98

Power supply	Colour	3000K
500mA		1T4540
500mA		1T4546

LED / 18W / REFLECTOR / WFL / CRI97



	3000K	H(m)	D(m)	Emax(lx)		
	Ra97		60°			
	Fixture Power	20W	1	1.16	1877	
	Source Flux	1924lm	2	2.32	469	
	Fixture Flux	1544lm	3	3.47	209	
	Efficacy	76lm/W	4	4.63	117	
TS859	I _{max} =976cd/klm	I _{max}	1878cd	5	5.79	75

Power supply	Colour	3000K
500mA		1T4551
500mA		1T4555

Related codes

Mounting System

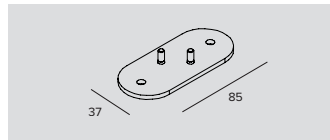

Colour	Code
	1T4606
	1T4607

White surface mounting base.

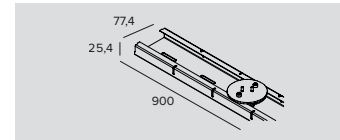

Colour	Code
	1T4628
	1T4629

Surface mounting channel 900mm.
The channel can be cut to length at intervals of 10cm.
With three mounting bases for Coro "Small" and "Big".

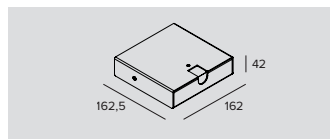

Power supply	Driving current	Driver	Colour	Code
220-240Vac 50/60Hz	900mA	EL.		1T4614
220-240Vac 50/60Hz	900mA	DALI		1T4615
220-240Vac 50/60Hz	900mA	DALI (CASAMBI)		1T4615CA
220-240Vac 50/60Hz	900mA	EL.		1T4624
220-240Vac 50/60Hz	900mA	DALI		1T4625
220-240Vac 50/60Hz	900mA	DALI (CASAMBI)		1T4625CA
220-240Vac 50/60Hz	350mA	DALI (CASAMBI)		1T4609CA
220-240Vac 50/60Hz	350mA	DALI (CASAMBI)		1T4619CA
220-240Vac 50/60Hz	500mA	DALI (CASAMBI)		1T4611CA
220-240Vac 50/60Hz	500mA	DALI (CASAMBI)		1T4621CA

Surface mounting base with integrated driver.

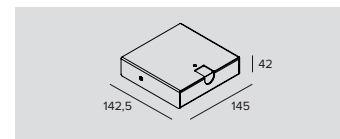

Power supply	Driving current	Driver	Colour	Code
220-240Vac 50/60Hz	350mA	EL.		1T4608
220-240Vac 50/60Hz	350mA	EL.		1T4618
220-240Vac 50/60Hz	350mA	DALI		1T4609
220-240Vac 50/60Hz	350mA	DALI		1T4619
220-240Vac 50/60Hz	500mA	EL.		1T4610
220-240Vac 50/60Hz	500mA	EL.		1T4620
220-240Vac 50/60Hz	500mA	DALI		1T4611
220-240Vac 50/60Hz	500mA	DALI		1T4621

Surface mounting base with integrated driver.

Power Supply

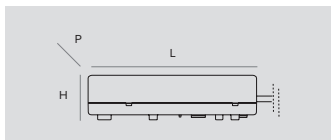

	Code
15W - 220-240V, 350mA - IP20 - 119x22x52mm	1T1757
max 50W - 220-240V, 900mA - IP20 - 160x35x83mm	1T2966
max 22W - 220-240V, 500mA - IP20 - 130x30x42mm	1T3966
Electronic power supply LxHxP	

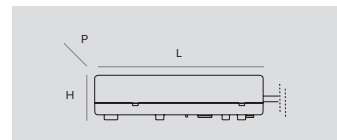

	Code
max 15W - 110-240V, 350mA - IP20 - 119x22x52mm	1T4630
20W - 220-240V, 500mA - IP20 - 119x22x52mm	1T4631
max 50W - 110-240V, 900mA - IP20 - 160x35x83mm	1T2968
DALI electronic power supply LxHxP	

Accessories

Filter

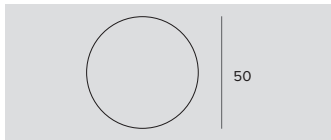

Filter	Ø	Code
Red	50	49881
Green	50	49882
Blue	50	49886
Yellow	50	49887
Magenta	50	49959

Flat glass interference chromatic filter.

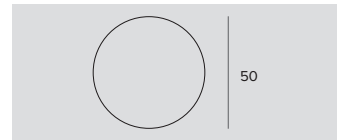

	Ø	Code
	50	1T4721

PMMA holographic filter with blade effect to ovalize the light beam; more evident when combined with spot and flood optics.



Filter	Ø	Code
Halogen +	50	1T6381
Vivid +	50	1T6383

Art filter.

Flat glass interference filter that can vary the colour parameters of the emission of the fixtures it is applied to.
To be used only with 3000K and Ra80 fixtures.

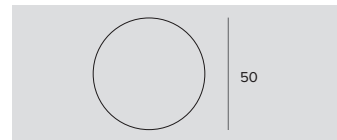

Filter	Ø	Code
Meat	50	1T6385
Fish	50	1T6387
Bread	50	1T6389
Vegetables	50	1T6391

Food filter.

Flat glass interference filter that can vary the colour parameters of the emission of the fixtures it is applied to.

1T6385, 1T6389, 1T6391

To be used only with 3000K and Ra80 fixtures.

1T6387

To be used only with 4000K and Ra80 fixtures.

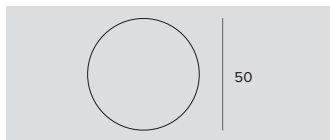

Filter	Ø	Code
Beauty	50	1T6393

Beauty filter.
Flat glass interference filter that can vary the colour parameters of the emission of the fixtures it is applied to.
To be used only with 3000K and Ra80 fixtures.

Screen



Ø	Code
50	1T4325

Black painted anodized diffusive aluminium asymmetric screen.
Complete with blade light filter.
Ideal for a Wall Washer effect.
To be combined with spot and flood optics.

Grid

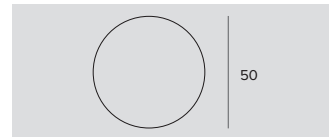

Ø	Code
50	1T4322

Anti-glare louver.
Black painted metal honeycomb structure.
Complete with holographic diffusion filter.

Zoom

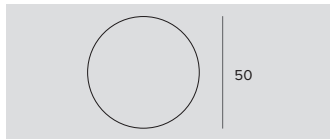

Ø	Code
50	1T4324

Zoom.
Optical system consists of an optical glass flat convex lens, an anodized aluminium specular reflector and a diffusive holographic filter.
To be used after removing the existing optic.
It can not be used with a narrow spot optic.
It makes it possible to obtain a variable beam from 15° to 60°.

Emergency Kit

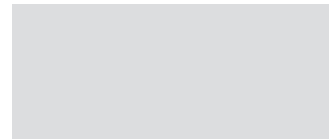

Code
1T3144

Emergency kit.
Inverter + 3h battery pack.
For CCTLED Architectural Mini: no NSP version.
IP20.

Control systems

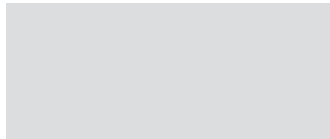

Code
1T5349

Wireless control unit for DALI fixtures.
It generates a local DALI bus that can control individual fixtures.
The module can be connected to an existing DALI network.
The module is wireless controlled using a Casambi app for smartphones and tablets using Bluetooth 4.0 technology.
The devices create a wireless mesh network that can control up to 128 fixtures.
IP20.

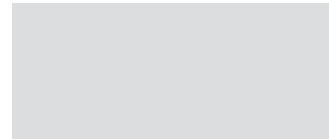

Code
1T5352

IP20 Extender for wireless control of DALI fixtures.
It generates a local DALI bus with the capacity to drive up to 64 fixtures.
Can control DALI fixtures in indoor applications.
It is also equipped with a relay that can control non-dimmable fixtures up to a maximum of 6A.



Merendoni Palace

Photographer
Ivan Rossi

Country
Bologna - Italy

OTTO

GENERAL INFO

Pole mounted projector.

Adjustable spotlight body from 0°/-90° on the vertical plane and 0/+90° and 0/-90° on the horizontal plane.

Ø30mm

LED

LED Emitter

From 370lm to 397lm

3000K – 4000K

Ra84

PRODUCT EFFICACY

Up to 30lm/W

OPTICS

ZOOM: from SP to FL

POWER SUPPLY

Remote electronic

MATERIAL

Painted or anodised aluminium body connected to a painted metal base.

A range of projectors with a minimal footprint with different installation types characterised by manual focus.

Available with single or multi-optical configuration: 1x, 2x or 3x.

Also available in ceiling mounted versions with the following installations: semi-recessed, recessed extractable and ceiling mounted with a base.





Project 107

Architect
The Ply Architecture

Photographer
Andrey Egorov

Country
Moscow - Russia

01



The pole version

Is suitable for lighting shop windows or showcases that require a controlled, modular and adjustable light.

02



Manual focus

It works exactly like a camera lens, rotating the optical unit extends it and the beam opening changes from 14° to 34°.



Ceiling

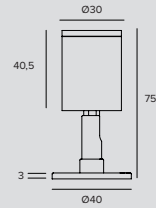

LED / 3W / ZOOM / SP-FL



	3000K	H(m)	D(m)	E _{max} (lx)
	Ra84		14°	
Fixture Power	5W	1	0.24	2069
Source Flux	370lm	2	0.49	517
Fixture Flux	117lm	3	0.73	230
Efficacy	23lm/W	4	0.98	129
TS1039	I _{max} =5593cd/klm	I _{max}	2069cd	5
	3000K <th>H(m)</th> <th>D(m)</th> <th>E_{max}(lx)</th>	H(m)	D(m)	E _{max} (lx)
	Ra84		34°	
Fixture Power	5W	1	0.62	481
Source Flux	370lm	2	1.23	120
Fixture Flux	141lm	3	1.85	53
Efficacy	28lm/W	4	2.46	30
TS1040	I _{max} =1301cd/klm	I _{max}	481cd	5

Power supply	Colour	3000K	4000K
1050mA	○	1T6331	1T6332
1050mA	●	1T6343	1T6344
1050mA	●	1T6355	1T6356

Related codes

Power Supply

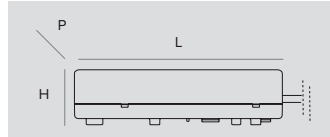

Code

1T6524

Electronic power supply 42W, LxHxP=129x30x42mm, 220-240V-AC 50-60Hz, 1050mA, IP20.
Can drive up to 12 OTTO 1x simultaneously.
OTTO Semi-Recessed: the driver is bigger than the cutout hole needed by the luminaire.

Accessories

Canopy



Ø	H	Colour	Code
40	18	○	1T6528
40	18	●	1T6529
40	18	●	1T6530

Canopy for electrical connection.



Multi-Optic 1x

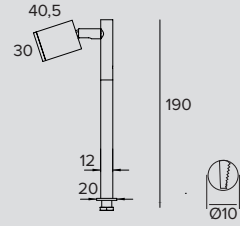

LED / 1x3W / ZOOM / SP-FL

		3000K		H(m)		D(m)		E _{max} (lx)	
		Ra84		14°					
Fixture Power	5W	1	0.24	2069					
Source Flux	370lm	2	0.49	517					
Fixture Flux	117lm	3	0.73	230					
Efficacy	23lm/W	4	0.98	129					
TS1039	I _{max} =5593cd/klm	I _{max}	2069cd	5	1.22	83			

		3000K		4000K	
Power supply	Colour	3000K	4000K		
1050mA	○	1T6325	1T6326		
1050mA	●	1T6337	1T6338		
1050mA	●	1T6349	1T6350		

		3000K		H(m)		D(m)		E _{max} (lx)	
		Ra84		34°					
Fixture Power	5W	1	0.62	481					
Source Flux	370lm	2	1.23	120					
Fixture Flux	141lm	3	1.85	53					
Efficacy	28lm/W	4	2.46	30					
TS1040	I _{max} =1301cd/klm	I _{max}	481cd	5	3.08	19			



Multi-Optic 2x

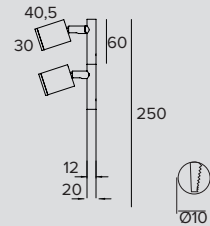

LED / 2x3W / ZOOM / SP-FL

		3000K		H(m)		D(m)		E _{max} (lx)	
		Ra84		14°					
Fixture Power	5W	1	0.24	2069					
Source Flux	370lm	2	0.49	517					
Fixture Flux	117lm	3	0.73	230					
Efficacy	23lm/W	4	0.98	129					
TS1039	I _{max} =5593cd/klm	I _{max}	2069cd	5	1.22	83			

		3000K		4000K	
Power supply	Colour	3000K	4000K		
1050mA	○	1T6327	1T6328		
1050mA	●	1T6339	1T6340		
1050mA	●	1T6351	1T6352		

		3000K		H(m)		D(m)		E _{max} (lx)	
		Ra84		34°					
Fixture Power	5W	1	0.62	481					
Source Flux	370lm	2	1.23	120					
Fixture Flux	141lm	3	1.85	53					
Efficacy	28lm/W	4	2.46	30					
TS1040	I _{max} =1301cd/klm	I _{max}	481cd	5	3.08	19			



Multi-Optic 3x

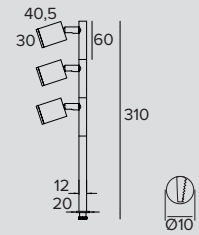

LED / 3x3W / ZOOM / SP-FL



		3000K	H(m)	D(m)	E _{max} (lx)	
		Ra84		14°		
Fixture Power	5W	1	0.24	2069		
Source Flux	370lm	2	0.49	517		
Fixture Flux	117lm	3	0.73	230		
Efficacy	23lm/W	4	0.98	129		
TS1039	I _{max} =5593cd/klm	I _{max}	2069cd	5	1.22	83

		3000K	H(m)	D(m)	E _{max} (lx)	
		Ra84		34°		
Fixture Power	5W	1	0.62	481		
Source Flux	370lm	2	1.23	120		
Fixture Flux	141lm	3	1.85	53		
Efficacy	28lm/W	4	2.46	30		
TS1040	I _{max} =1301cd/klm	I _{max}	481cd	5	3.08	19

Power supply	Colour	3000K	4000K
1050mA	○	1T6329	1T6330
1050mA	●	1T6341	1T6342
1050mA	●	1T6353	1T6354

Related codes

Power Supply

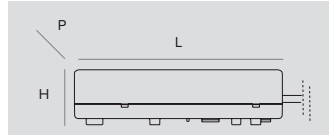

Code

1T6524

Electronic power supply 42W, LxHxP=129x30x42mm, 220-240V-AC 50-60Hz, 1050mA, IP20.

Can drive up to 12 OTTO 1x simultaneously.

OTTO Semi-Recessed: the driver is bigger than the cutout hole needed by the luminaire.

Accessories

Base

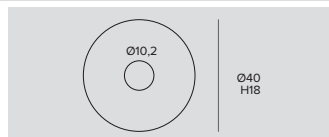

Ø	H	Colour	Code
40	18	○	1T6525
40	18	●	1T6526
40	18	●	1T6527

Base for electrical connection.

Indoor

Systems

Systems 48V



332
OZ



358
FORTYEIGHT

Systems 230V



376
LOGICO
System

OZ

GENERAL INFO

POWER TRACK

Lengths: 1000mm – 2000mm – 3000mm
L, T and X linear electrical connections.

MAGNETIC LED LIGHT UNIT

SMALL fixed and adjustable

LARGE fixed and adjustable

5x SMALL fixed

3x LARGE fixed

PROFILE

Profile for recessed, ceiling mounted and suspension installation with a double Large and Small section.

Lengths: 1000mm – 2000mm – 3000mm

LED

Emitter for version SMALL.

Chip on Board for version LARGE.

From 135lm to 2418lm

2700K - 3000K - 3500K - 4000K

Ra90

PRODUCT EFFICACY

Up to 103lm/W

OPTICS

SP – FL – MWFL

POWER SUPPLY

Electronic - Casambi on board

MATERIAL

POWER TRACK

Black or white polycarbonate with 2 conductive stainless steel rails. Black or white polycarbonate cover.

MAGNETIC LED LIGHT UNIT

Black or white painted die-cast aluminium.

Acrylic lens and black polycarbonate screen.

PROFILE

Black or white painted extruded aluminium.

The idea behind OZ came from the desire to create a system that is decisive as well as simple and minimal. A system that designs and illumines the space with its modules and form.

The heart of the system is the power track, an advanced conductive track, 6 mm thick, that unwinds through the space, bringing 48V of power and on which the lighting units, which are available in various beam angles, are hooked using magnets. The system can be left visible for surface installations, highlighting its lightness and technology, or built into the profiles for installation on surfaces, as suspension, or recessed.

Also available in a ceiling mounted or recessed stand-alone 230V version.





01



The power track is the heart of the system

The power track is available in three different lengths, black or white. For an effect of formal simplicity it is possible to accessorise the power-track with the cover that hides the two metal tracks. The cover can be easily cut to size on installation.

02



The light modules are available in two different sizes

Both extremely compact: 25x25x50 f and 50x50x50 both in fixed and adjustable version. They can have a white body with a black cover or be completely black.

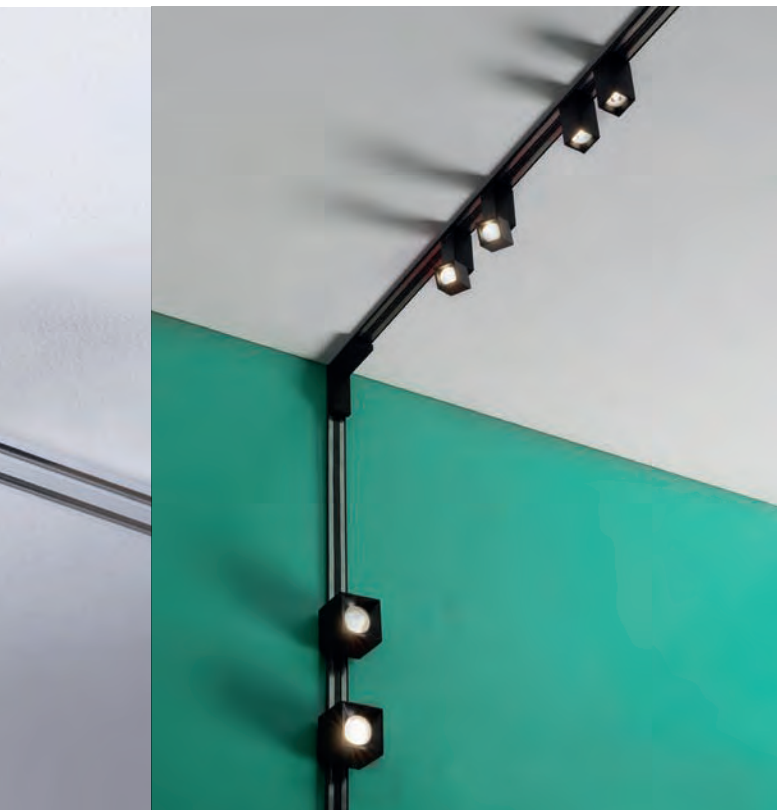

Innovative 48V magnetic system

Installing modules is really easy, just place them at any point on the system and the magnets will attach them without the need for accessories.

New light modules

New 3x multi-optical light modules for the Large version and 5x for the Small version, available both in an electronic and Casambi version for remote control of light points. This allows for independent autonomous management of light points on the same track to create different scenarios as needed.

There are five different installation solutions for maximum application flexibility.

OZ can be installed on the wall or ceiling with just one power track. Using the special outer casings it can be recessed on existing false ceilings, or suspended or installed on surface.

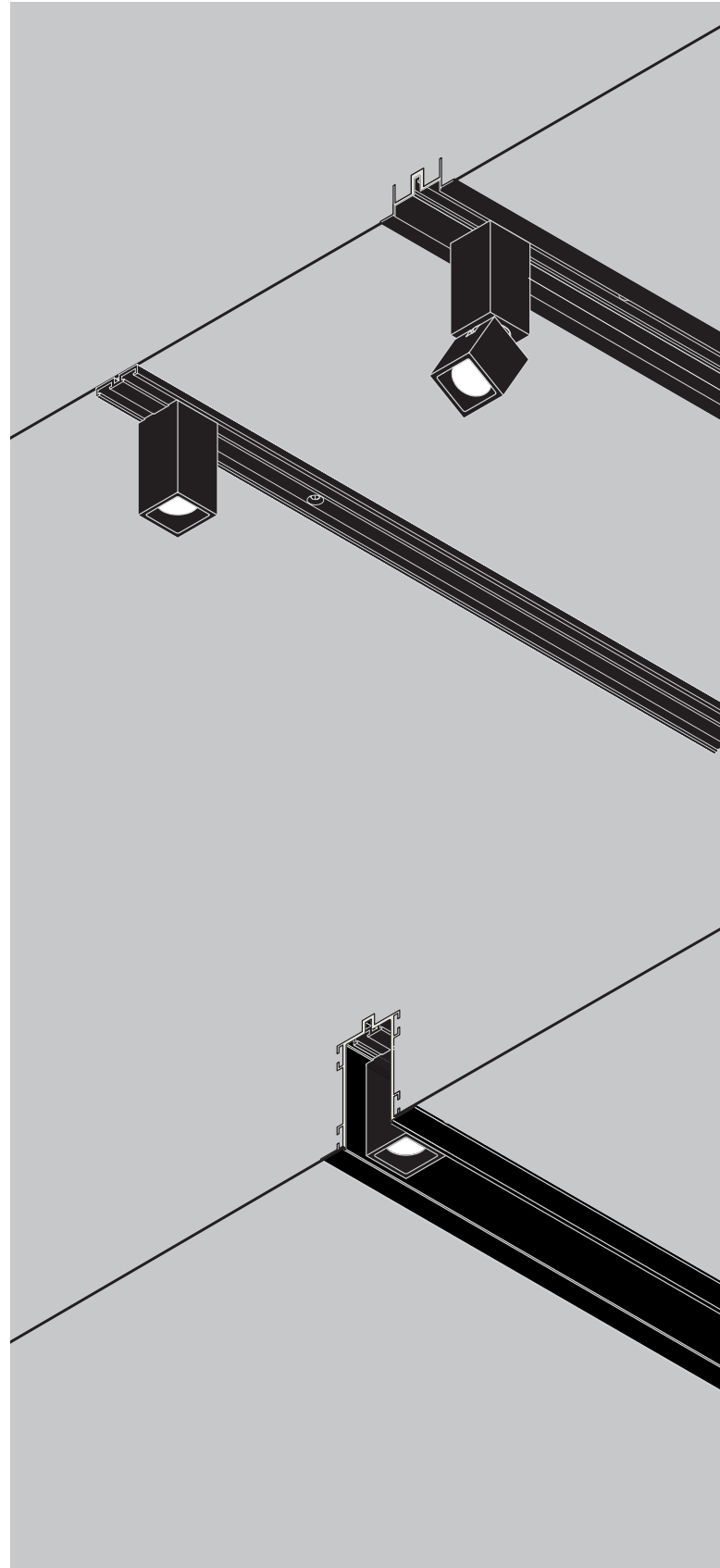

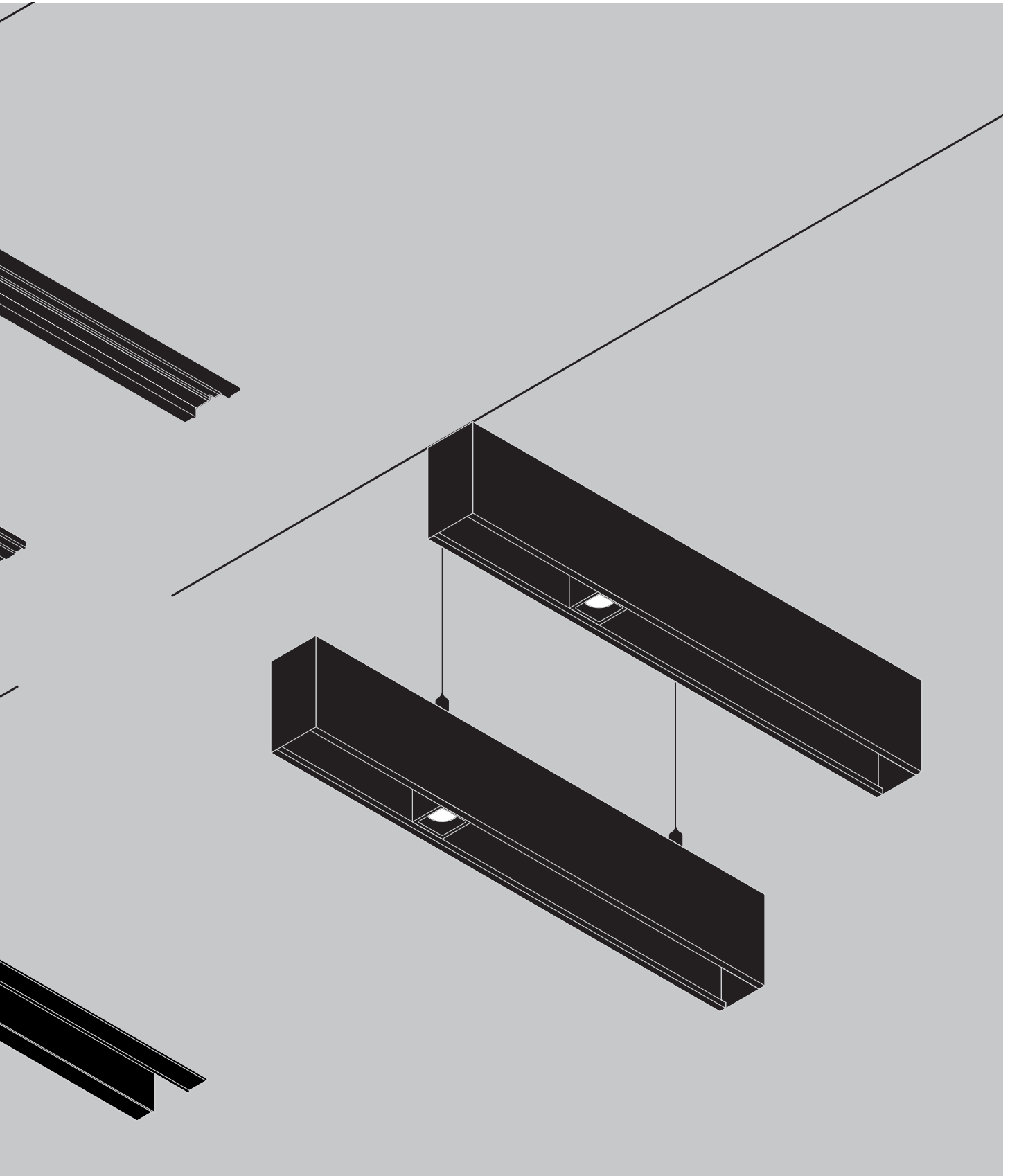





The same profile for recessed installation (with flange or trimless)

Using mechanical joins and the various installation accessories infinite compositions can be created.

The rules of OZ

5

Is the maximum number of connectors that can be used in the same configuration

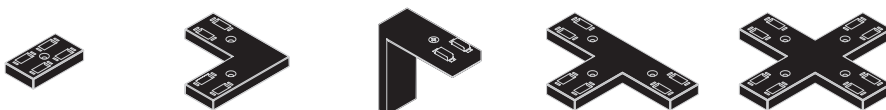

10

Metres is the maximum length of a configuration connected to the same power supply

0

Are the closed systems that can be created. Only closed systems with 4 L-joints are allowed.

3

Is the maximum number of **Large** light units that can be installed side by side (group).

5

Is the maximum number of **Small** light units that can be installed side by side (group).



2

Are the number of groups that can be on 1 metre of the system.

100

Watt is the maximum power that can be installed per metre. The total power of the configuration varies according to the type of driver used.

3

Is the number of power supplies

∞

Possible solutions

- Integrated box driver on board max 90W
- Ceiling-mounted box driver max 90W
- Remote driver max 210W

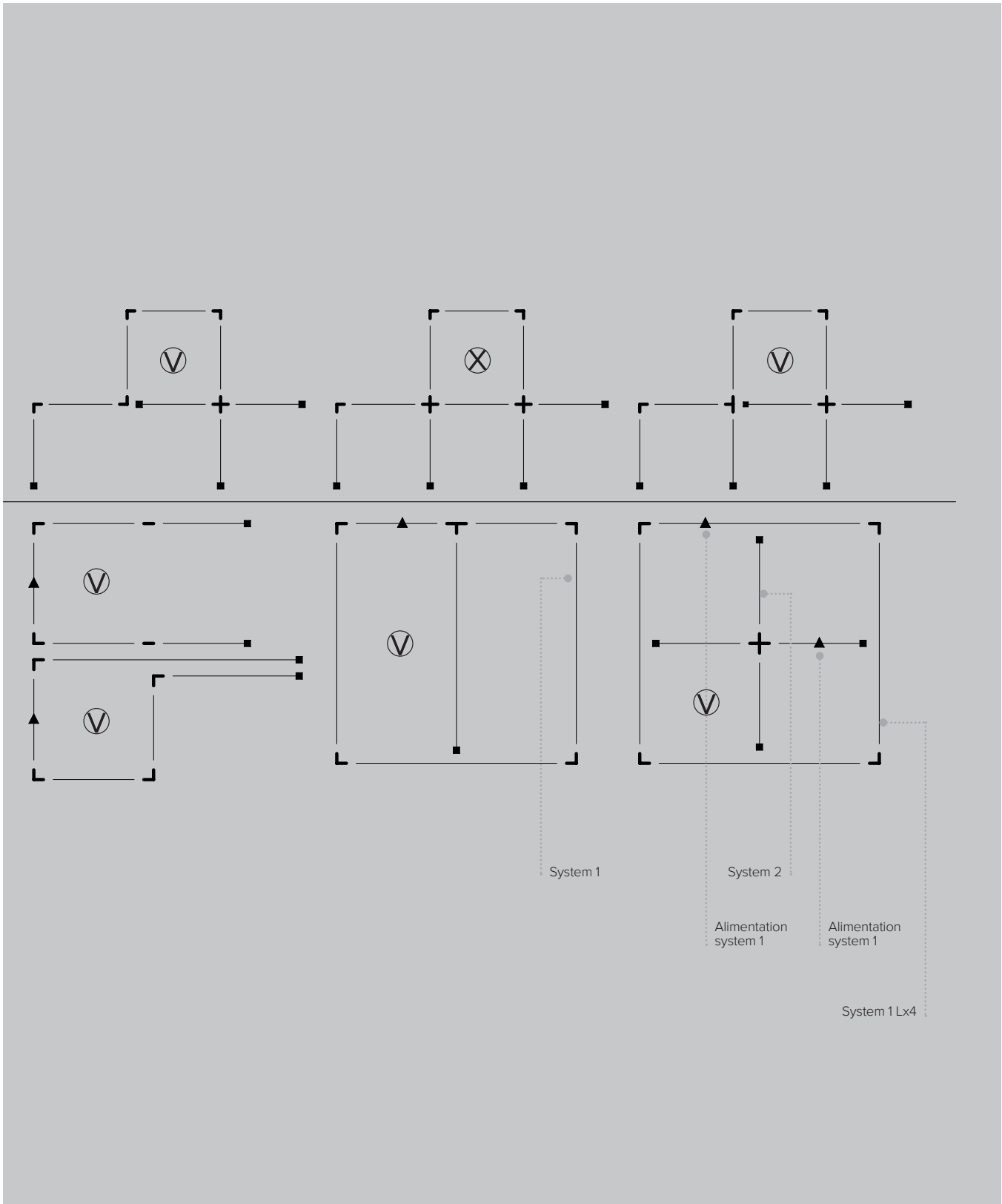

07



On request

it is possible to have the cover in the desired RAL colour.

08



Three power supply options

- Box driver installato come rosone con l'aggiunta della testata di alimentazione nel sistema;
- Box driver remoto con l'aggiunta della testata di alimentazione nel sistema;
- Alimentazione installata direttamente su power track in qualsiasi punto del sistema.

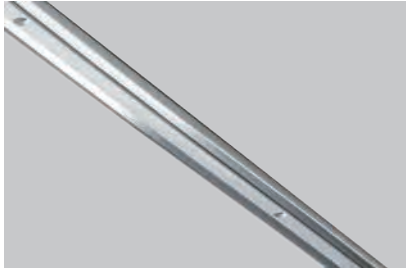

Power Track

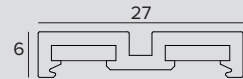

POWER TRACK IP20

	Kg	L	Colour	Code
	0.3	1000	○	1T7431
	0.59	2000	○	1T7432
	0.89	3000	○	1T7433
	0.3	1000	●	1T7434
	0.59	2000	●	1T7435
	0.89	3000	●	1T7436

Related codes

End Caps

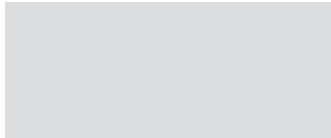
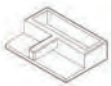

Colour	Code
○	1T7026
●	1T7027

Kit containing 2 profile end caps.

Power head

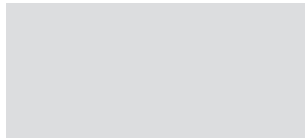
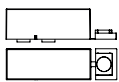

Colour		Code
○	Power head 71x25x27	1T7024
●	Power head 71x25x27	1T7025

Driver on board

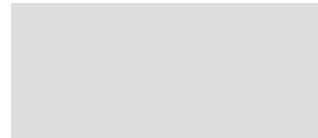

Colour		Code
○	48Vdc driver magnetic box 238x54.2x26mm - 90W	1T7028EL
●	48Vdc driver magnetic box 238x54.2x26mm - 90W	1T7029EL

Remote power supply

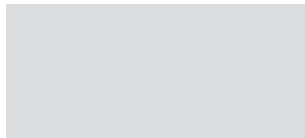

	Code
Driver IP20 60W - 225x36x60 maximum distance 20m - cable 1,5mmq	1T6917EL
Driver IP20 130W - 240x49x60 maximum distance 10m - cable 1,5mmq	1T6916EL
Driver IP20 210W - 251x90x37 maximum distance 5m - cable 1,5mmq	1T7403EL

Universal power supply for Electronic and Casambi systems.

Driver box for ceiling installation

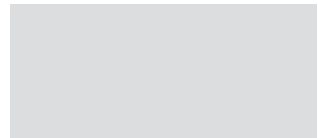
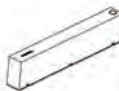

Colour		Code
○	Driver box for ceiling installation 243x58x30mm - 90W	1T7030EL
●	Driver box for ceiling installation 243x58x30mm - 90W	1T7172EL

OZ

Accessories

Electrical Connector

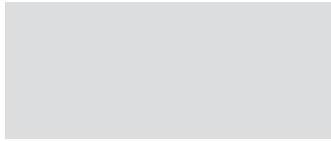

Colour	Code
○	1T7016
●	1T7020

Linear electrical connector.
5 the maximum joints for each driver source.

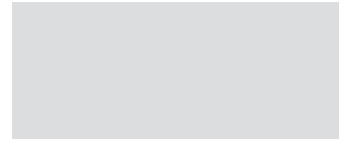

Colour	Code
○	1T7017
●	1T7021

Electrical L connector.
5 the maximum joints for each driver source.

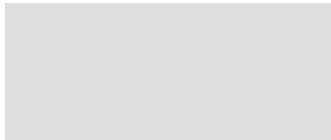

Colour	Code
○	1T7018
●	1T7022

Electrical T connector.
5 the maximum joints for each driver source.

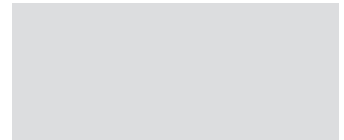

Colour	Code
○	1T7019
●	1T7023

Electrical X connector.
5 the maximum joints for each driver source.

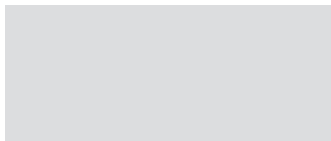

Colour	Code
○	1T7439
●	1T7440

L-angle electrical coupling.
5 the maximum joints for each driver source.

Cover Panel

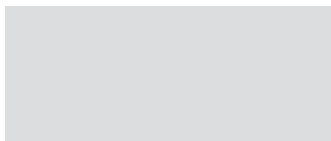

L	Colour	Code
1000	○	1T7938
1000	●	1T7941
2000	○	1T7939
2000	●	1T7942
3000	○	1T7940
3000	●	1T7943

Cover for Power Track (5 pieces).

Mounting System

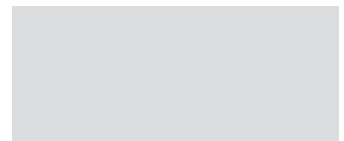

Code
1T7098

BI-ADHESIVE TAPE 10 meters for Power Track installation.



Lighting module - Single fixed 25x25mm

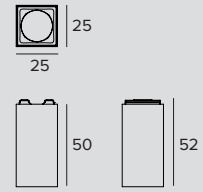

LED / 2,1W / LENS / SP											
	3000K	H(m)	D(m)	Emax(lx)		Version	Colour	2700K	3000K	3500K	4000K
	Ra90			11°		EL	○	1T7506	1T7507	1T7508	1T7509
	Fixture Power	3W	1	0.20	2505	EL	●	1T7518	1T7519	1T7520	1T7521
	Source Flux	197lm	2	0.40	626	CASAMBI	○	1T7099CA	1T7100CA	1T7101CA	1T7102CA
	Fixture Flux	154lm	3	0.60	278	CASAMBI	●	1T7111CA	1T7112CA	1T7113CA	1T7114CA
	Efficacy	45lm/W	4	0.79	157						
TS1122	Imax=12713cd/klm	Imax	2505cd	5	0.99						

LED / 2,1W / LENS / FL											
	3000K	H(m)	D(m)	Emax(lx)		Version	Colour	2700K	3000K	3500K	4000K
	Ra90			28°		EL	○	1T7510	1T7511	1T7512	1T7513
	Fixture Power	3W	1	0.51	497	EL	●	1T7522	1T7523	1T7524	1T7525
	Source Flux	197lm	2	1.01	124	CASAMBI	○	1T7103CA	1T7104CA	1T7105CA	1T7106CA
	Fixture Flux	148lm	3	1.52	55	CASAMBI	●	1T7115CA	1T7116CA	1T7117CA	1T7118CA
	Efficacy	43lm/W	4	2.02	31						
TS1123	Imax=2525cd/klm	Imax	497cd	5	2.53						

LED / 2,1W / LENS / MWFL											
	3000K	H(m)	D(m)	Emax(lx)		Version	Colour	2700K	3000K	3500K	4000K
	Ra90			41°		EL	○	1T7514	1T7515	1T7516	1T7517
	Fixture Power	3W	1	0.75	256	EL	●	1T7526	1T7527	1T7528	1T7529
	Source Flux	197lm	2	1.50	64	CASAMBI	○	1T7107CA	1T7108CA	1T7109CA	1T7110CA
	Fixture Flux	142lm	3	2.26	28	CASAMBI	●	1T7119CA	1T7120CA	1T7121CA	1T7122CA
	Efficacy	42lm/W	4	3.01	16						
TS1124	Imax=1300cd/klm	Imax	256cd	5	3.76						

LED / 2,6W / LENS / SP											
	3000K	H(m)	D(m)	Emax(lx)		Version	Colour	2700K	3000K	3500K	4000K
	Ra90			11°		EL	○	1T7099	1T7100	1T7101	1T7102
	Fixture Power	4W	1	0.20	3000	EL	●	1T7111	1T7112	1T7113	1T7114
	Source Flux	236lm	2	0.40	750						
	Fixture Flux	184lm	3	0.60	333						
	Efficacy	44lm/W	4	0.79	188						
TS 1122	Imax=12713cd/klm	Imax	3000cd	5	0.99						

LED / 2,6W / LENS / FL											
	3000K	H(m)	D(m)	Emax(lx)		Version	Colour	2700K	3000K	3500K	4000K
	Ra90			28°		EL	○	1T7103	1T7104	1T7105	1T7106
	Fixture Power	4W	1	0.51	596	EL	●	1T7115	1T7116	1T7117	1T7118
	Source Flux	236lm	2	1.01	149						
	Fixture Flux	177lm	3	1.52	66						
	Efficacy	42lm/W	4	2.02	37						
TS 1123	Imax=2525cd/klm	Imax	596cd	5	2.53						

LED / 2,6W / LENS / MWFL



		3000K	H(m)	D(m)	E _{max} (lx)
		Ra90			
		41°			
Fixture Power	4W	1	0.75	307	
Source Flux	236lm	2	1.50	77	
Fixture Flux	170lm	3	2.26	34	
Efficacy	41lm/W	4	3.01	19	
TS 1124	I _{max} =1300cd/klm	I _{max}	307cd	5	3.76

Version	Colour	2700K	3000K	3500K	4000K
FIXED	○	1T7107	1T7108	1T7109	1T7110
FIXED	●	1T7119	1T7120	1T7121	1T7122



Lighting module - Single adjustable 25x25mm

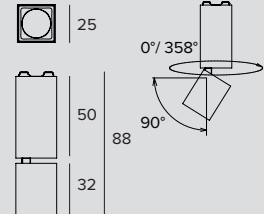

LED / 2,1W / LENS / SP



		3000K	H(m)	D(m)	E _{max} (lx)
		Ra90			
		11°			
Fixture Power	3W	1	0.20	2505	
Source Flux	197lm	2	0.40	626	
Fixture Flux	154lm	3	0.60	278	
Efficacy	45lm/W	4	0.79	157	
TS 1122	I _{max} =12713cd/klm	I _{max}	2505cd	5	0.99

Version	Colour	2700K	3000K	3500K	4000K
EL	○	1T7530	1T7531	1T7532	1T7533
EL	●	1T7542	1T7543	1T7544	1T7545
CASAMBI	○	1T7123CA	1T7124CA	1T7125CA	1T7126CA
CASAMBI	●	1T7135CA	1T7136CA	1T7137CA	1T7138CA

LED / 2,1W / LENS / FL

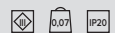

		3000K	H(m)	D(m)	E _{max} (lx)
		Ra90			
		28°			
Fixture Power	3W	1	0.51	497	
Source Flux	197lm	2	1.01	124	
Fixture Flux	148lm	3	1.52	55	
Efficacy	43lm/W	4	2.02	31	
TS 1123	I _{max} =2525cd/klm	I _{max}	497cd	5	2.53

Version	Colour	2700K	3000K	3500K	4000K
EL	○	1T7534	1T7535	1T7536	1T7537
EL	●	1T7546	1T7547	1T7548	1T7549
CASAMBI	○	1T7127CA	1T7128CA	1T7129CA	1T7130CA
CASAMBI	●	1T7139CA	1T7140CA	1T7141CA	1T7142CA

LED / 2,1W / LENS / MWFL



		3000K	H(m)	D(m)	E _{max} (lx)
		Ra90			
		41°			
Fixture Power	3W	1	0.75	256	
Source Flux	197lm	2	1.50	64	
Fixture Flux	142lm	3	2.26	28	
Efficacy	42lm/W	4	3.01	16	
TS 1124	I _{max} =1300cd/klm	I _{max}	256cd	5	3.76

Version	Colour	2700K	3000K	3500K	4000K
EL	○	1T7538	1T7539	1T7540	1T7541
EL	●	1T7550	1T7551	1T7552	1T7553
CASAMBI	○	1T7131CA	1T7132CA	1T7133CA	1T7134CA
CASAMBI	●	1T7143CA	1T7144CA	1T7145CA	1T7146CA

LED / 2,6W / LENS / SP



		3000K	H(m)	D(m)	E _{max} (lx)
		Ra90			
		11°			
Fixture Power	4W	1	0.20	3000	
Source Flux	236lm	2	0.40	750	
Fixture Flux	184lm	3	0.60	333	
Efficacy	44lm/W	4	0.79	188	
TS 1122	I _{max} =12713cd/klm	I _{max}	3000cd	5	0.99

Version	Colour	2700K	3000K	3500K	4000K
EL	○	1T7123	1T7124	1T7125	1T7126
EL	●	1T7135	1T7136	1T7137	1T7138

LED / 2,6W / LENS / FL



3000K		H(m)	D(m)	E _{max} (lx)		
Ra90			28°			
Fixture Power	4W	1	0.51	596		
Source Flux	236lm	2	1.01	149		
Fixture Flux	177lm	3	1.52	66		
Efficacy	42lm/W	4	2.02	37		
TS 1123	I _{max} =2525cd/klm	I _{max}	596cd	5	2.53	24

Version	Colour	2700K	3000K	3500K	4000K
EL	○	1T7127	1T7128	1T7129	1T7130
EL	●	1T7139	1T7140	1T7141	1T7142

LED / 2,6W / LENS / MWFL



3000K		H(m)	D(m)	E _{max} (lx)		
Ra90			41°			
Fixture Power	4W	1	0.75	307		
Source Flux	236lm	2	1.50	77		
Fixture Flux	170lm	3	2.26	34		
Efficacy	41lm/W	4	3.01	19		
TS 1124	I _{max} =1300cd/klm	I _{max}	307cd	5	3.76	12

Version	Colour	2700K	3000K	3500K	4000K
EL	○	1T7131	1T7132	1T7133	1T7134
EL	●	1T7143	1T7144	1T7145	1T7146



Lighting module - Single fixed 50x50mm

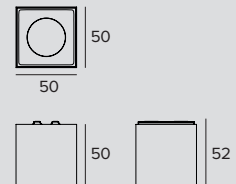

LED / 6,8W / REFLECTOR / SP



3000K		H(m)	D(m)	E _{max} (lx)		
Ra90			19°			
Fixture Power	8W	1	0.34	3911		
Source Flux	846lm	2	0.68	978		
Fixture Flux	691lm	3	1.02	435		
Efficacy	87lm/W	4	1.36	244		
TS1125	I _{max} =4623cd/klm	I _{max}	3911cd	5	1.70	156

Version	Colour	2700K	3000K	3500K	4000K
EL	○	1T7554	1T7555	1T7556	1T7557
EL	●	1T7566	1T7567	1T7568	1T7569
CASAMBI	○	1T7147CA	1T7148CA	1T7149CA	1T7150CA
CASAMBI	●	1T7159CA	1T7160CA	1T7161CA	1T7162CA

LED / 7,6W / REFLECTOR / FL



3000K		H(m)	D(m)	E _{max} (lx)		
Ra90			27°			
Fixture Power	9W	1	0.49	2359		
Source Flux	963lm	2	0.98	590		
Fixture Flux	720lm	3	1.47	262		
Efficacy	82lm/W	4	1.95	147		
TS1126	I _{max} =2450cd/klm	I _{max}	2359cd	5	2.44	94

Version	Colour	2700K	3000K	3500K	4000K
EL	○	1T7558	1T7559	1T7560	1T7561
EL	●	1T7570	1T7571	1T7572	1T7573
CASAMBI	○	1T7151CA	1T7152CA	1T7153CA	1T7154CA
CASAMBI	●	1T7163CA	1T7164CA	1T7165CA	1T7166CA

LED / 7,6W / REFLECTOR / MWFL



3000K		H(m)	D(m)	E _{max} (lx)		
Ra90			37°			
Fixture Power	9W	1	0.66	1826		
Source Flux	963lm	2	1.32	457		
Fixture Flux	794lm	3	1.98	203		
Efficacy	90lm/W	4	2.64	114		
TS1127	I _{max} =1896cd/klm	I _{max}	1826cd	5	3.31	73

Version	Colour	2700K	3000K	3500K	4000K
EL	○	1T7562	1T7563	1T7564	1T7565
EL	●	1T7574	1T7575	1T7576	1T7577
CASAMBI	○	1T7155CA	1T7156CA	1T7157CA	1T7158CA
CASAMBI	●	1T7167CA	1T7168CA	1T7169CA	1T7170CA

LED / 7,5W / REFLECTOR / SP



		3000K	H(m)	D(m)	E _{max} (lx)
Ra90				19°	
Fixture Power	9W	1	0.34	4752	
Source Flux	1028lm	2	0.68	1188	
Fixture Flux	840lm	3	1.02	528	
Efficacy	97lm/W	4	1.36	297	
TS 1125	I _{max} =4623cd/klm	I _{max}	4752cd	5	1.70
					190

Version	Colour	2700K	3000K	3500K	4000K
EL	○	1T7147	1T7148	1T7149	1T7150
EL	●	1T7159	1T7160	1T7161	1T7162

LED / 8,3W / REFLECTOR / FL



		3000K	H(m)	D(m)	E _{max} (lx)
Ra90				27°	
Fixture Power	10W	1	0.49	2896	
Source Flux	1182lm	2	0.98	724	
Fixture Flux	884lm	3	1.47	322	
Efficacy	92lm/W	4	1.95	181	
TS 1126	I _{max} =2450cd/klm	I _{max}	2896cd	5	2.44
					116

Version	Colour	2700K	3000K	3500K	4000K
EL	○	1T7151	1T7152	1T7153	1T7154
EL	●	1T7163	1T7164	1T7165	1T7166

LED / 8,3W / REFLECTOR / MWFL



		3000K	H(m)	D(m)	E _{max} (lx)
Ra90				37°	
Fixture Power	10W	1	0.66	2241	
Source Flux	1182lm	2	1.32	560	
Fixture Flux	974lm	3	1.98	249	
Efficacy	101lm/W	4	2.64	140	
TS 1127	I _{max} =1896cd/klm	I _{max}	2241cd	5	3.31
					90

Version	Colour	2700K	3000K	3500K	4000K
EL	○	1T7155	1T7156	1T7157	1T7158
EL	●	1T7167	1T7168	1T7169	1T7170

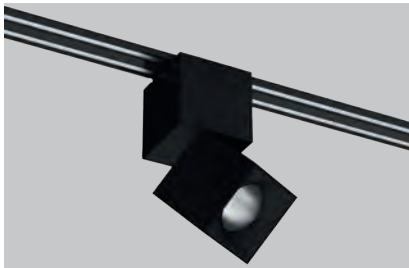

Lighting module - Single adjustable 50x50mm

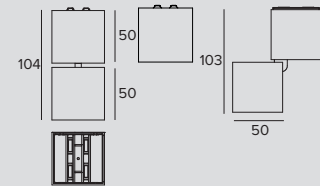

LED / 6,8W / REFLECTOR / SP



		3000K	H(m)	D(m)	E _{max} (lx)
Ra90				19°	
Fixture Power	8W	1	0.34	3911	
Source Flux	846lm	2	0.68	978	
Fixture Flux	691lm	3	1.02	435	
Efficacy	87lm/W	4	1.36	244	
TS 1125	I _{max} =4623cd/klm	I _{max}	3911cd	5	1.70
					156

Version	Colour	2700K	3000K	3500K	4000K
EL	○	1T7578	1T7579	1T7580	1T7581
EL	●	1T7590	1T7591	1T7592	1T7593
CASAMBI	○	1T7407CA	1T7408CA	1T7409CA	1T7410CA
CASAMBI	●	1T7419CA	1T7420CA	1T7421CA	1T7422CA

LED / 7,6W / REFLECTOR / FL



		3000K	H(m)	D(m)	E _{max} (lx)
Ra90				27°	
Fixture Power	9W	1	0.49	2359	
Source Flux	963lm	2	0.98	590	
Fixture Flux	720lm	3	1.47	262	
Efficacy	82lm/W	4	1.95	147	
TS 1126	I _{max} =2450cd/klm	I _{max}	2359cd	5	2.44
					94

Version	Colour	2700K	3000K	3500K	4000K
EL	○	1T7582	1T7583	1T7584	1T7585
EL	●	1T7594	1T7595	1T7596	1T7597
CASAMBI	○	1T7411CA	1T7412CA	1T7413CA	1T7414CA
CASAMBI	●	1T7423CA	1T7424CA	1T7425CA	1T7426CA

LED / 7,6W / REFLECTOR / MWFL



	3000K	H(m)	D(m)	E _{max} (lx)		
	Ra90		37°			
	Fixture Power	9W	1	0.66	1826	
	Source Flux	963lm	2	1.32	457	
	Fixture Flux	794lm	3	1.98	203	
	Efficacy	90lm/W	4	2.64	114	
TS1127	I _{max} =1896cd/klm	I _{max}	1826cd	5	3.31	73

Version	Colour	2700K	3000K	3500K	4000K
EL	○	1T7586	1T7587	1T7588	1T7589
EL	●	1T7598	1T7599	1T7600	1T7601
CASAMBI	○	1T7415CA	1T7416CA	1T7417CA	1T7418CA
CASAMBI	●	1T7427CA	1T7428CA	1T7429CA	1T7430CA

LED / 7,5W / REFLECTOR / SP



	3000K	H(m)	D(m)	E _{max} (lx)		
	Ra90		19°			
	Fixture Power	9W	1	0.34	4752	
	Source Flux	1028lm	2	0.68	1188	
	Fixture Flux	840lm	3	1.02	528	
	Efficacy	97lm/W	4	1.36	297	
TS1171	I _{max} =4623cd/klm	I _{max}	4752cd	5	1.70	190

Version	Colour	2700K	3000K	3500K	4000K
EL	○	1T7407	1T7408	1T7409	1T7410
EL	●	1T7419	1T7420	1T7421	1T7422

LED / 8,3W / REFLECTOR / FL



	3000K	H(m)	D(m)	E _{max} (lx)		
	Ra90		27°			
	Fixture Power	10W	1	0.49	2896	
	Source Flux	1182lm	2	0.98	724	
	Fixture Flux	884lm	3	1.47	322	
	Efficacy	92lm/W	4	1.95	181	
TS1172	I _{max} =2450cd/klm	I _{max}	2896cd	5	2.44	116

Version	Colour	2700K	3000K	3500K	4000K
EL	○	1T7411	1T7412	1T7413	1T7414
EL	●	1T7423	1T7424	1T7425	1T7426

LED / 8,3W / REFLECTOR / MWFL



	3000K	H(m)	D(m)	E _{max} (lx)		
	Ra90		37°			
	Fixture Power	10W	1	0.66	2241	
	Source Flux	1182lm	2	1.32	560	
	Fixture Flux	974lm	3	1.98	249	
	Efficacy	101lm/W	4	2.64	140	
TS1173	I _{max} =1896cd/klm	I _{max}	2241cd	5	3.31	90

Version	Colour	2700K	3000K	3500K	4000K
EL	○	1T7415	1T7416	1T7417	1T7418
EL	●	1T7427	1T7428	1T7429	1T7430



Lighting module - Multiple Piccolo 5X (25x125mm)

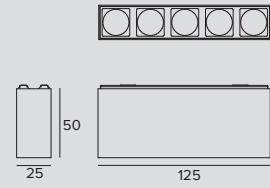

8,7W / LENS / SP



	3000K	H(m)	D(m)	Emax(lx)		
	Ra90		11°			
	Fixture Power	9W	1	0.20	10018	
	Source Flux	788lm	2	0.40	2505	
	Fixture Flux	615lm	3	0.60	1113	
	Efficacy	68lm/W	4	0.79	626	
TS1122	Imax=12713cd/klm	Imax	10018cd	5	0.99	401

Version	Colour	2700K	3000K	3500K	4000K
5X	○	1T7441	1T7442	1T7443	1T7444
5X	●	1T7453	1T7454	1T7455	1T7456

8,7W / LENS / SP



	3000K	H(m)	D(m)	Emax(lx)		
	Ra90		11°			
	Fixture Power	11W	1	0.20	10018	
	Source Flux	788lm	2	0.40	2505	
	Fixture Flux	615lm	3	0.60	1113	
	Efficacy	55lm/W	4	0.79	626	
TS1122	Imax=12713cd/klm	Imax	10018cd	5	0.99	401

Version	Colour	2700K	3000K	3500K	4000K
5X CASAMBI	○	1T7441CA	1T7442CA	1T7443CA	1T7444CA
5X CASAMBI	●	1T7453CA	1T7454CA	1T7455CA	1T7456CA

8,7W / LENS / FL



	3000K	H(m)	D(m)	Emax(lx)		
	Ra90		28°			
	Fixture Power	9W	1	0.51	1990	
	Source Flux	788lm	2	1.01	497	
	Fixture Flux	590lm	3	1.52	221	
	Efficacy	65lm/W	4	2.02	124	
TS1123	Imax=2525cd/klm	Imax	1990cd	5	2.53	80

Version	Colour	2700K	3000K	3500K	4000K
5X	○	1T7445	1T7446	1T7447	1T7448
5X	●	1T7457	1T7458	1T7459	1T7460

8,7W / LENS / FL



	3000K	H(m)	D(m)	Emax(lx)		
	Ra90		28°			
	Fixture Power	11W	1	0.51	1990	
	Source Flux	788lm	2	1.01	497	
	Fixture Flux	590lm	3	1.52	221	
	Efficacy	53lm/W	4	2.02	124	
TS1123	Imax=2525cd/klm	Imax	1990cd	5	2.53	80

Version	Colour	2700K	3000K	3500K	4000K
5X CASAMBI	○	1T7445CA	1T7446CA	1T7447CA	1T7448CA
5X CASAMBI	●	1T7457CA	1T7458CA	1T7459CA	1T7460CA

8,7W / LENS / MWFL



	3000K	H(m)	D(m)	Emax(lx)		
	Ra90		41°			
	Fixture Power	9W	1	0.75	1024	
	Source Flux	788lm	2	1.50	256	
	Fixture Flux	569lm	3	2.26	114	
	Efficacy	63lm/W	4	3.01	64	
TS1124	Imax=1300cd/klm	Imax	1024cd	5	3.76	41

Version	Colour	2700K	3000K	3500K	4000K
5X	○	1T7449	1T7450	1T7451	1T7452
5X	●	1T7461	1T7462	1T7463	1T7464

8,7W / LENS / MWFL

	3000K	H(m)	D(m)	Emax(lx)		
	Ra90		41°			
	Fixture Power	11W	1	0.75	1024	
	Source Flux	788lm	2	1.50	256	
	Fixture Flux	569lm	3	2.26	114	
	Efficacy	51lm/W	4	3.01	64	
TS1124	Imax=1300cd/klm	Imax	1024cd	5	3.76	41

Version	Colour	2700K	3000K	3500K	4000K
5X CASAMBI	○	1T7449CA	1T7450CA	1T7451CA	1T7452CA
5X CASAMBI	●	1T7461CA	1T7462CA	1T7463CA	1T7464CA



Lighting module - Multiple Grande 3X (50x150mm)

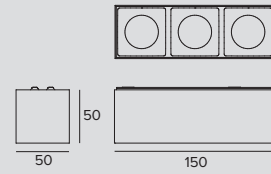

21W / REFLECTOR / SP



	3000K	H(m)	D(m)	E _{max} (lx)		
	Ra90		19°			
Fixture Power	21W	1	0.34	11732		
Source Flux	2538lm	2	0.68	2933		
Fixture Flux	2074lm	3	1.02	1304		
Efficacy	97lm/W	4	1.36	733		
TS1125	I _{max} =4623cd/klm	I _{max}	11732cd	5	1.70	469

Version	Colour	2700K	3000K	3500K	4000K
3X	○	1T7465	1T7466	1T7467	1T7468
3X	●	1T7477	1T7478	1T7479	1T7480

21W / REFLECTOR / SP



	3000K	H(m)	D(m)	E _{max} (lx)		
	Ra90		19°			
Fixture Power	23W	1	0.34	11732		
Source Flux	2538lm	2	0.68	2933		
Fixture Flux	2074lm	3	1.02	1304		
Efficacy	91lm/W	4	1.36	733		
TS1125	I _{max} =4623cd/klm	I _{max}	11732cd	5	1.70	469

Version	Colour	2700K	3000K	3500K	4000K
3X CASAMBI	○	1T7465CA	1T7466CA	1T7467CA	1T7468CA
3X CASAMBI	●	1T7477CA	1T7478CA	1T7479CA	1T7480CA

23W / REFLECTOR / FL



	3000K	H(m)	D(m)	E _{max} (lx)		
	Ra90		27°			
Fixture Power	24W	1	0.49	7077		
Source Flux	2889lm	2	0.98	1769		
Fixture Flux	2161lm	3	1.47	786		
Efficacy	91lm/W	4	1.95	442		
TS1126	I _{max} =2450cd/klm	I _{max}	7077cd	5	2.44	283

Version	Colour	2700K	3000K	3500K	4000K
3X	○	1T7469	1T7470	1T7471	1T7472
3X	●	1T7481	1T7482	1T7483	1T7484

23W / REFLECTOR / FL

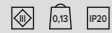

	3000K	H(m)	D(m)	E _{max} (lx)		
	Ra90		27°			
Fixture Power	25W	1	0.49	7077		
Source Flux	2889lm	2	0.98	1769		
Fixture Flux	2161lm	3	1.47	786		
Efficacy	85lm/W	4	1.95	442		
TS1126	I _{max} =2450cd/klm	I _{max}	7077cd	5	2.44	283

Version	Colour	2700K	3000K	3500K	4000K
3X CASAMBI	○	1T7469CA	1T7470CA	1T7471CA	1T7472CA
3X CASAMBI	●	1T7481CA	1T7482CA	1T7483CA	1T7484CA

23W / REFLECTOR / MWFL



	3000K	H(m)	D(m)	E _{max} (lx)		
	Ra90		37°			
Fixture Power	24W	1	0.66	5478		
Source Flux	2889lm	2	1.32	1370		
Fixture Flux	2381lm	3	1.98	609		
Efficacy	100lm/W	4	2.64	342		
TS1127	I _{max} =1896cd/klm	I _{max}	5478cd	5	3.31	219

Version	Colour	2700K	3000K	3500K	4000K
3X	○	1T7473	1T7474	1T7475	1T7476
3X	●	1T7485	1T7486	1T7487	1T7488

22,8W / REFLECTOR / MWFL



	3000K	H(m)	D(m)	E _{max} (lx)		
	Ra90		37°			
Fixture Power	25W	1	0.66	5478		
Source Flux	2889lm	2	1.32	1370		
Fixture Flux	2381lm	3	1.98	609		
Efficacy	94lm/W	4	2.64	342		
TS1127	I _{max} =1896cd/klm	I _{max}	5478cd	5	3.31	219

Version	Colour	2700K	3000K	3500K	4000K
3X CASAMBI	○	1T7473CA	1T7474CA	1T7475CA	1T7476CA
3X CASAMBI	●	1T7485CA	1T7486CA	1T7487CA	1T7488CA



Recessed profile small

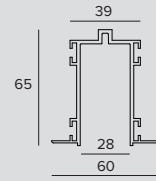

PROFILO

Recessed profile for 25x25mm light modules.
Extruded painted aluminium profile.
For trimless installation or with a flange.
To be completed with Power Track.

	Kg	L	Colour	Code
	1.1	1000	○	1T7031
	2.2	2000	○	1T7032
	3.3	3000	○	1T7033
	1.1	1000	●	1T7034
	2.2	2000	●	1T7035
	3.3	3000	●	1T7036



Recessed profile large

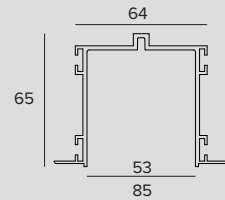

PROFILO

Recessed profile for 25x25mm and 50x50mm light modules.
Extruded painted aluminium profile.
For trimless installation or with a flange.
To be completed with Power Track.

	Kg	L	Colour	Code
	1.2	1000	○	1T7067
	2.5	2000	○	1T7068
	3.7	3000	○	1T7069
	1.2	1000	●	1T7070
	2.5	2000	●	1T7071
	3.7	3000	●	1T7072

Related codes

Mounting System

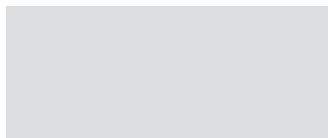

Code

1T7043

Steel bracket for recessed installation of the small profile.
2 pieces to be ordered for 1m long modules, 3 pieces for 2m long modules and 4 pieces for 3m long modules.

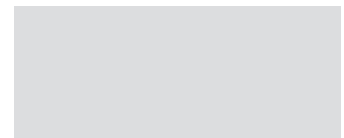

Code

1T7076

Steel bracket for recessed installation of the large profile.
2 pieces to be ordered for 1m long modules, 3 pieces for 2m long modules and 4 pieces for 3m long modules.

End Caps

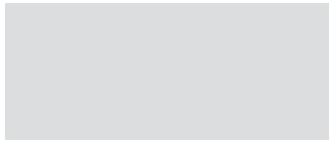
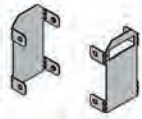

Colour	Code
○	1T7039
●	1T7040

Kit containing 2 profile end caps.
For small recessed profiles.

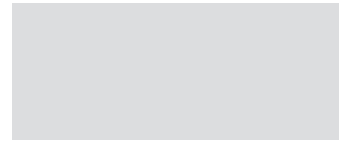
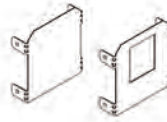

Colour	Code
○	1T7073
●	1T7074

Kit containing 2 profile end caps.
For large recessed profiles.

Accessories

Mechanical connector

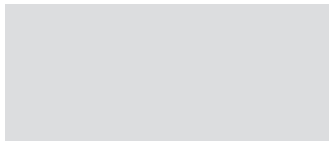

Code
1T7041

Kit composed of 2 mechanical linear joints and 4 thrust screws.
For trimless installation profile.

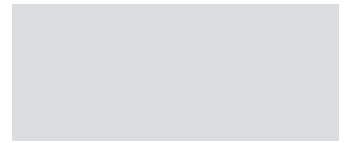

Colour	Code
○	1T7037
●	1T7038

Mechanical L connector.
For small recessed profiles.

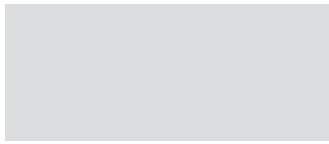
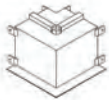

Colour	Code
○	1T7437
●	1T7438

Mechanical L connector.
For large recessed profiles.



Ceiling/Suspension installation profile small

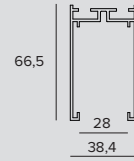

HEAD MODULE

Ceiling/suspension installation profile for 25x25mm light modules.

Extruded painted aluminium profile.

For stand-alone installation only used head modules.

For system installation it is necessary to start the configuration with a head module.

For closed configurations, you need to order two head modules to be installed opposite.

To be completed with Power Track.

	Kg	L	Colour	Code
	0.8	1015	○	1T7050
	1.7	2015	○	1T7051
	2.6	3015	○	1T7052
	0.8	1015	●	1T7053
	1.7	2015	●	1T7054
	2.6	3015	●	1T7055

CENTRAL/END MODULE

Ceiling/suspension installation profile for 25x25mm light modules.

Extruded painted aluminium profile.

For stand-alone installation only used head modules.

For system installation it is necessary to start the configuration with a head module.

For closed configurations, you need to order two head modules to be installed opposite.

To be completed with Power Track.

	Kg	L	Colour	Code
	0.8	1000	○	1T7044
	1.7	2000	○	1T7045
	2.6	3000	○	1T7046
	0.8	1000	●	1T7047
	1.7	2000	●	1T7048
	2.6	3000	●	1T7049



Ceiling/Suspension installation profile large

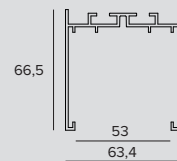

HEAD MODULE

Ceiling/suspension installation profile for 25x25mm and 50x50mm light modules.

Extruded painted aluminium profile.

For stand-alone installation only used head modules.

For system installation it is necessary to start the configuration with a head module.

For closed configurations, you need to order two head modules to be installed opposite.

To be completed with Power Track.

	Kg	L	Colour	Code
	1	1015	○	1T7083
	2.1	2015	○	1T7084
	3.1	3015	○	1T7085
	1	1015	●	1T7086
	2.1	2015	●	1T7087
	3.1	3015	●	1T7088

CENTRAL/END MODULE



Ceiling/suspension installation profile for 25x25mm and 50x50mm light modules.

Extruded painted aluminium profile.

For stand-alone installation only used head modules.

For system installation it is necessary to start the configuration with a head module.

For closed configurations, you need to order two head modules to be installed opposite.

To be completed with Power Track.

	Kg	L	Colour	Code
	1	1000	○	1T7077
	2.1	2000	○	1T7078
	3.1	3000	○	1T7079
	1	1000	●	1T7080
	2.1	2000	●	1T7081
	3.1	3000	●	1T7082

Related codes

End Caps

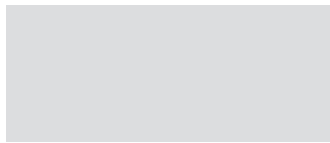

Colour	Code
○	1T7062
●	1T7063

Kit containing 2 profile end caps.
For small ceiling/suspension mounted profiles.

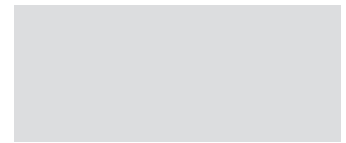

Colour	Code
○	1T7095
●	1T7096

Kit containing 2 profile end caps.
For large ceiling/suspension mounted profiles.

Mounting System

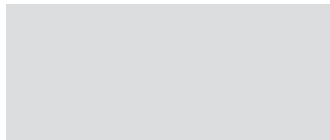

Code
1T7065

Ceiling installation kit.
2 pieces to be ordered for 1m long modules, 3 pieces for 2m long modules and 4 pieces for 3m long modules.

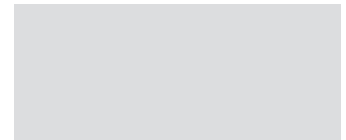

Code
1T7066

Suspension installation kit.
2 pieces to be ordered for 1m long modules, 3 pieces for 2m long modules and 4 pieces for 3m long modules.

Accessories

Mechanical connector

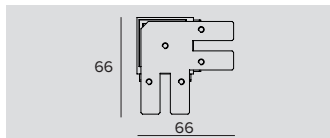

Colour	Code
○	1T7056
●	1T7059

Mechanical L connector.
For small ceiling/suspension mounted profiles.

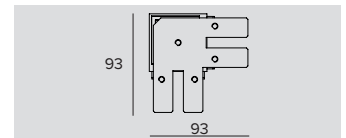
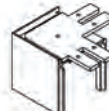

Colour	Code
○	1T7089
●	1T7092

Mechanical L connector.
For large ceiling/suspension mounted profiles.

OZ

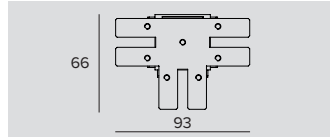

Colour Code

○ **1T7057**

● **1T7060**

Mechanical T connector.
For small ceiling/suspension mounted profiles.

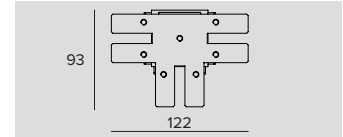
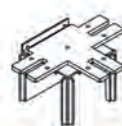

Colour Code

○ **1T7090**

● **1T7093**

Mechanical T connector.
For large ceiling/suspension mounted profiles.

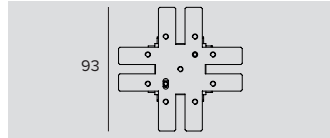

Colour Code

○ **1T7058**

● **1T7061**

Mechanical X connector.
For small ceiling/suspension mounted profiles.

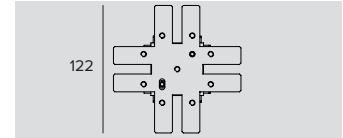
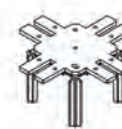

Colour Code

○ **1T7091**

● **1T7094**

Mechanical X connector.
For large ceiling/suspension mounted profiles.

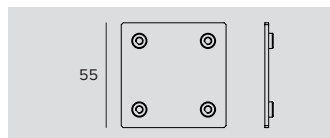
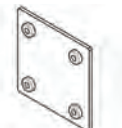

Colour Code

○ **1T7064**

● **1T7097**

Kit composed of 2 mechanical linear joints and 8 thrust screws.
For ceiling/suspension installation profile.

Recessed profile for Power Track

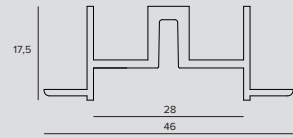

HEAD MODULE



Recessed profile for Power Track.
Extruded painted aluminium profile.
For trimless installation or with a flange.
To be completed with Power Track.

Kg	L	Colour	Code
0.4	1015	○	1T7495
0.8	2015	○	1T7496
1.2	3015	○	1T7497
0.4	1015	●	1T7498
0.8	2015	●	1T7499
1.2	3015	●	1T7500

CENTRAL/END MODULE

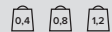

Recessed profile for Power Track.
Extruded painted aluminium profile.
For trimless installation or with a flange.
To be completed with Power Track.

Kg	L	Colour	Code
0.4	1000	○	1T7489
0.8	2000	○	1T7490
1.2	3000	○	1T7491
0.4	1000	●	1T7492
0.8	2000	●	1T7493
1.2	3000	●	1T7494

Related codes

Mounting System



Code

1T7501

Steel bracket for Power Track built-in installation.
2 pieces to be ordered for 1m long modules, 3 pieces for 2m long modules and 4 pieces for 3m long modules.

FORTYEIGHT

GENERAL INFO

TRACK

A modular system with variable lengths to be equipped with projectors and linear light fixtures. The track version varies depending on the type of installation.

LABEL

Projectors for track installation available in a double version with a short and long bracket depending on the type of installation selected.

The optical unit can be adjusted from 0° a 90° on the vertical plane and 360° on the horizontal plane with friction blocking system.

Ø40mm – Ø60mm

LOGICO 30

Low voltage linear LED fixture for track installation.

Lengths: 294mm – 573mm – 1132mm – 1970mm

L Module: 310mm

LED

LABEL4 and 6: Chip on board Ra90

LABEL 2: LED emitter Ra90

From 124lm to 1821lm

2700K – 3000K – 4000K

LOGICO 30: Linear boards Ra90

From 750lm to 5600lm

3000K – 4000K

PRODUCT EFFICACY

LABEL: up to 107lm/W

LOGICO 30: up to 77 lm/W

OPTICS

LABEL: SP – FL – MWFL

LOGICO 30: OPAL

POWER SUPPLY

Electronic – DALI

Casambi control: the DALI version is fitted with special accessories.

MATERIAL

LABEL: Painted extruded aluminium body.

LOGICO 30: Painted extruded aluminium body

A 48V system that can be recessed or deep recessed both with a trimless finish, ceiling or wall and suspension mounted. It can be fitted at any point with linear lighting fixtures due to its simple mechanical fixing system.

It is very small in size 27mm in width by 21mm - 25mm or 53mm in height.

The deep recessed version must be equipped with LABEL projectors with long brackets.





Bally

Lighting design
Ing. Angelo Iorio,
U&Me Consulting

Country
Milan - Italy



There are two recessed versions both with a trimless finish:

- Simple recessed with a flush system and protruding fixtures
- Deep recessed completely hidden in the ceiling with linear light elements. For this version the projectors have a longer bracket to allow for maximum extraction and adjustability.

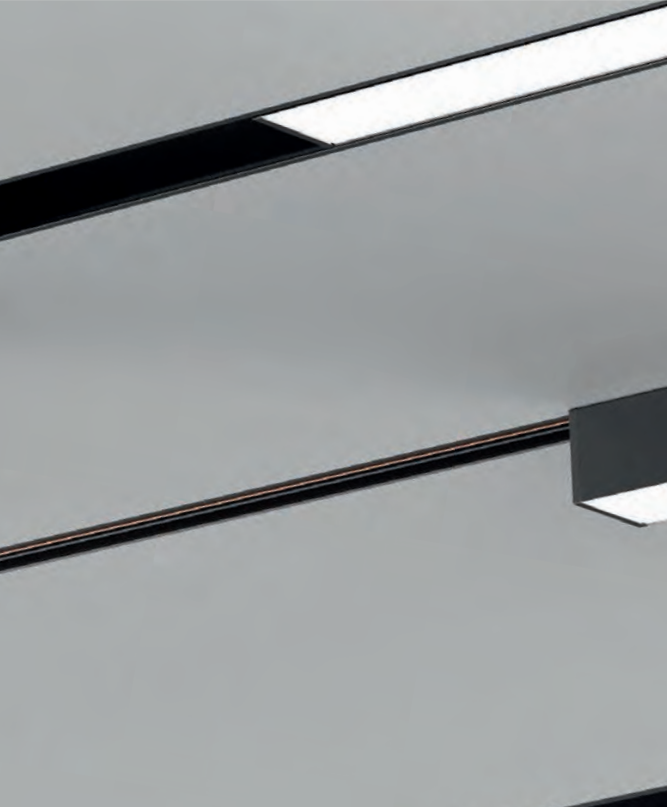

Wall mounted installation

For effective easy lighting for example in retail spaces
such as shop windows.

03
Logico 30



Linear modules
complete with
opaline screens

For a soft and diffused lighting effect equipped with LED 3000K and 4000K sources with Ra90.

The system can
be configured in
various ways

Thanks to the use of linear joints and the new corner joints that make it possible to create closed and open loops. Available a new corner light module for lines of seamless light.

04 Label 48V



48V projectors available in three sizes

Specially designed for applications in the retail, interior and hotel sectors with a simple, minimal shape and small dimensions. All versions have a remote power supply to minimise any visual impact. The new LABEL 2 (Ø20 mm), LABEL 4 (Ø40 mm) and LABEL 6 (Ø59 mm) are all equipped with Ra90 LED sources with 2700K, 3000K and 4000K colour temperatures.

05 Label 2

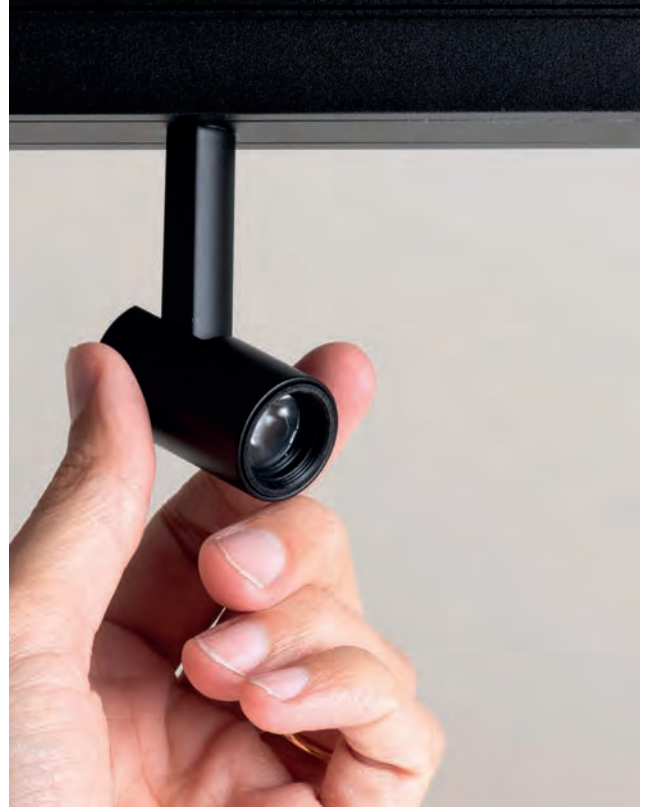

New LABEL 2

The new miniaturised projector enhances the LABEL range. Just 20 mm in diameter for a 4W projector with a professional performance. Available with three different optics equipped with lenses for the SP - FL - MWFL versions.



Track standard

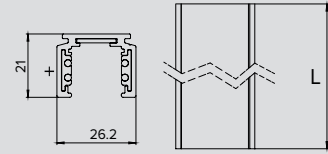

STANDARD

Kg	L	Colour	Code
0.7	1000	○	9500-1/W2-ST1
1.4	2000	○	9500-2/W2-ST1
2.1	3000	○	9500-3/W2-ST1
0.7	1000	●	9500-1/B-ST1
1.4	2000	●	9500-2/B-ST1
2.1	3000	●	9500-3/B-ST1



Track trimless

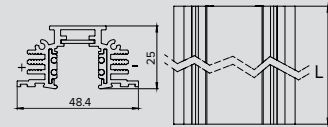

TRIMLESS

Kg	L	Colour	Code
1.1	1000	○	9500-1/W2-ST3
2.2	2000	○	9500-2/W2-ST3
3.4	3000	○	9500-3/W2-ST3
1.1	1000	●	9500-1/B-ST3
2.2	2000	●	9500-2/B-ST3
3.4	3000	●	9500-3/B-ST3



Track trimless deep

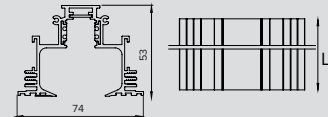

TRIMLESS DEEP

Kg	L	Colour	Code
1.6	1000	○	9500-1/W2-TA1
3.2	2000	○	9500-2/W2-TA1
4.8	3000	○	9500-3/W2-TA1
1.6	1000	●	9500-1/B-TA1
3.2	2000	●	9500-2/B-TA1
4.8	3000	●	9500-3/B-TA1

FORTYEIGHT

Related codes

End Caps

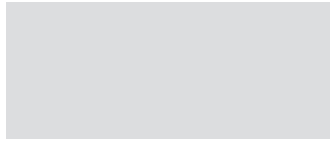

Colour	Code
○	9504/ST1-W2
●	9504/ST1-B

End cap for Standard track.
1X

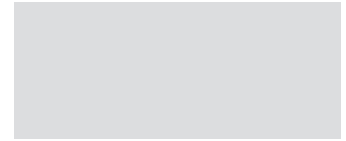

Colour	Code
○	9504/ST3-W2
●	9504/ST3-B

End cap for Trimless track.
1X

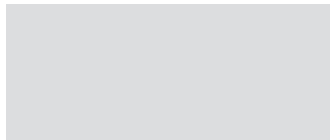

Colour	Code
○	1T7171
●	1T6801

End cap for Trimless Deep track.
2X

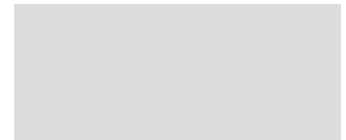

Colour	Code
○	9504/ST1-W2-F
●	9504/ST1-B-F

End cap for Standard track with a cable feedthrough hole.
1X

Mounting System

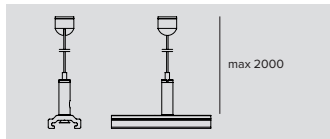

Colour	Code
○	1T6802
●	1T6804

Suspension kit with ABS control over the fixture.

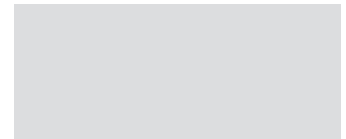

Colour	Code
○	S-9500/315

Bracket for trimless applications.
For every metre of track 4 brackets must be used, 2 for each side.

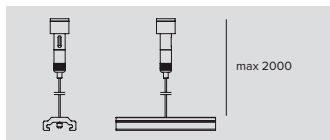

Colour	Code
○	1T6803
●	1T6805

Suspension kit with ceiling adjustment.

Power Supply

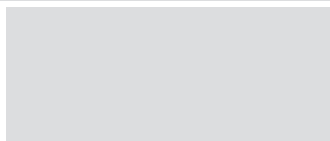

Code
1T6917EL

Driver 48Vdc 60W EL.
LxHxP=225x36x60mm - maximum distance 20m - cable 1.5mm².
IP20.
Universal power supply for Electronic, DALI and Casambi systems.

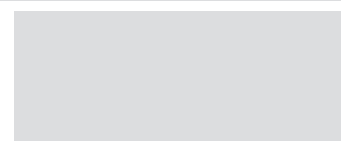

Code
1T6916EL

Driver 48Vdc 130W EL.
LxHxP=240x49x60mm - maximum distance 10m - cable 1.5mm².
IP20.
Universal power supply for Electronic, DALI and Casambi systems.



Colour	Code
○	9501-S/W
●	9501-S/B

Power head unpolarised.

Accessories

Mechanical connector



Colour	Code
○	S-9500/314-W2
●	S-9500/314-B

Reinforcement bracket for direct coupling for trimless applications.

Tool



Code
S-9000/T

Tool for shearing conductors, to be used if necessary to cut the track during installation.

Electrical Connector

 <table border="1"> <thead> <tr> <th>Colour</th> <th>Code</th> </tr> </thead> <tbody> <tr> <td>○</td> <td>9511/W2</td> </tr> <tr> <td>●</td> <td>9511/B</td> </tr> </tbody> </table> <p>Unpolarised L joint. Only for recessed installation. For L joints the tracks must first be cut to 45°.</p>	Colour	Code	○	9511/W2	●	9511/B	 <table border="1"> <thead> <tr> <th>Colour</th> <th>Code</th> </tr> </thead> <tbody> <tr> <td>○</td> <td>9503-S/W</td> </tr> <tr> <td>●</td> <td>9503-S/B</td> </tr> </tbody> </table> <p>Unpolarised through joint.</p>	Colour	Code	○	9503-S/W	●	9503-S/B
Colour	Code												
○	9511/W2												
●	9511/B												
Colour	Code												
○	9503-S/W												
●	9503-S/B												

Control systems



Code
1T5352

IP20 Extender for wireless control of DALI fixtures.
It generates a local DALI bus with the capacity to drive up to 64 fixtures.
Can control DALI fixtures in indoor applications.
It is also equipped with a relay that can control non-dimmable fixtures up to a maximum of 6A.

FORTYEIGHT



Logico 30
L. 294mm

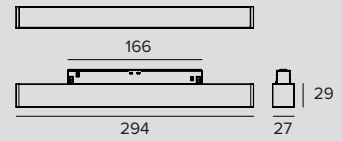

LED / 6W / OPAL



		3000K	H(m)	D(m)	Emax(lx)	
		Ra90		107°		
Fixture Power	7W	1	2.70	177		
Source Flux	750lm	2	5.41	44		
Fixture Flux	467lm	3	8.11	20		
Efficacy	67lm/W	4	10.81	11		
TS1075	Imax=237cd/klm	Imax	177cd	5	13.52	7

Power supply	Version	Colour	3000K	4000K
48Vdc	EL.	○	1T6619EL	1T6620EL
48Vdc	EL.	●	1T6621EL	1T6622EL
48Vdc	DALI	○	1T6619DA	1T6620DA
48Vdc	DALI	●	1T6621DA	1T6622DA



Logico 30
L. 573mm

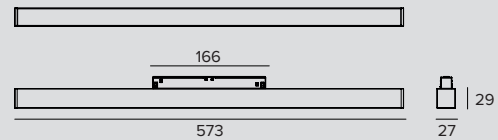

LED / 12W / OPAL

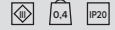

		3000K	H(m)	D(m)	Emax(lx)	
		Ra90		107°		
Fixture Power	13W	1	2.70	355		
Source Flux	1500lm	2	5.41	89		
Fixture Flux	934lm	3	8.11	39		
Efficacy	72lm/W	4	10.81	22		
TS1075	Imax=237cd/klm	Imax	355cd	5	13.52	14

Power supply	Version	Colour	3000K	4000K
48Vdc	EL.	○	1T6623EL	1T6624EL
48Vdc	EL.	●	1T6625EL	1T6626EL
48Vdc	DALI	○	1T6623DA	1T6624DA
48Vdc	DALI	●	1T6625DA	1T6626DA



Logico 30
L. 1132mm

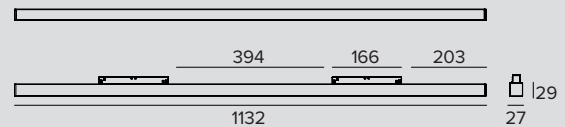

LED / 24W / OPAL



		3000K	H(m)	D(m)	Emax(lx)	
		Ra90		107°		
Fixture Power	26W	1	2.70	710		
Source Flux	3000lm	2	5.41	177		
Fixture Flux	1868lm	3	8.11	79		
Efficacy	72lm/W	4	10.81	44		
TS1075	Imax=237cd/klm	Imax	710cd	5	13.52	28

Power supply	Version	Colour	3000K	4000K
48Vdc	EL.	○	1T6627EL	1T6628EL
48Vdc	EL.	●	1T6629EL	1T6630EL
48Vdc	DALI	○	1T6627DA	1T6628DA
48Vdc	DALI	●	1T6629DA	1T6630DA



Logico 30 L. 1970mm

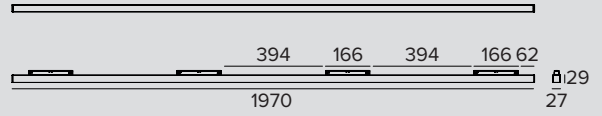

LED / 42W / OPAL



		3000K	H(m)	D(m)	E _{max} (lx)
		Ra90		107°	
Fixture Power	46W	1	2.70	1242	
Source Flux	5250lm	2	5.41	311	
Fixture Flux	3269lm	3	8.11	138	
Efficacy	71lm/W	4	10.81	78	
TS1075	I _{max} =237cd/klm	I _{max}	1242cd	5	13.52
				50	

Power supply	Version	Colour	3000K	4000K
48Vdc	EL.	○	1T6631EL	1T6632EL
48Vdc	EL.	●	1T6633EL	1T6634EL
48Vdc	DALI	○	1T6631DA	1T6632DA
48Vdc	DALI	●	1T6633DA	1T6634DA



Logico 30 L

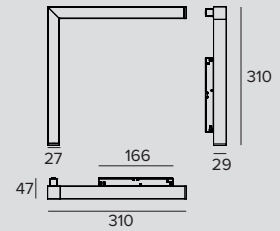

LED / 12W / OPAL



		3000K	H(m)	D(m)	E _{max} (lx)
		Ra90		107°	
Fixture Power	13W	1	2.70	355	
Source Flux	1500lm	2	5.41	89	
Fixture Flux	934lm	3	8.11	39	
Efficacy	72lm/W	4	10.81	22	
TS1075	I _{max} =237cd/klm	I _{max}	355cd	5	13.52
				14	

Power supply	Version	Colour	3000K	4000K
48Vdc	EL.	○	1T6635EL	1T6636EL
48Vdc	EL.	●	1T6637EL	1T6638EL
48Vdc	DALI	○	1T6635DA	1T6636DA
48Vdc	DALI	●	1T6637DA	1T6638DA

FORTYEIGHT



Label 2 short arm

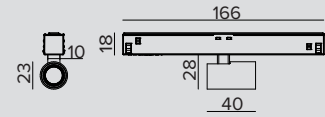

LED / 2,6W / LENS / SP



		3000K	H(m)	D(m)	E _{max} (lx)	
Ra90				13°		
Fixture Power	4W	1	0.23	1419		
Source Flux	180lm	2	0.45	355		
Fixture Flux	152lm	3	0.68	158		
Efficacy	40lm/W	4	0.90	89		
TS1157	I _{max} =7873cd/klm	I _{max}	1419cd	5	1.13	57

Power supply	Version	Colour	2700K	3000K	4000K
48Vdc	EL.	○	1T6639EL	1T6640EL	1T6641EL
48Vdc	EL.	●	1T6642EL	1T6643EL	1T6644EL
48Vdc	DALI	○	1T6639DA	1T6640DA	1T6641DA
48Vdc	DALI	●	1T6642DA	1T6643DA	1T6644DA

LED / 2,6W / LENS / FL



		3000K	H(m)	D(m)	E _{max} (lx)	
Ra90				31°		
Fixture Power	4W	1	0.55	346		
Source Flux	180lm	2	1.10	87		
Fixture Flux	136lm	3	1.65	38		
Efficacy	36lm/W	4	2.19	22		
TS1158	I _{max} =1920cd/klm	I _{max}	346cd	5	2.74	14

Power supply	Version	Colour	2700K	3000K	4000K
48Vdc	EL.	○	1T6645EL	1T6646EL	1T6647EL
48Vdc	EL.	●	1T6648EL	1T6649EL	1T6650EL
48Vdc	DALI	○	1T6645DA	1T6646DA	1T6647DA
48Vdc	DALI	●	1T6648DA	1T6649DA	1T6650DA

LED / 2,6W / LENS / MWFL



		3000K	H(m)	D(m)	E _{max} (lx)	
Ra90				49°		
Fixture Power	4W	1	0.90	177		
Source Flux	180lm	2	1.81	44		
Fixture Flux	131lm	3	2.71	20		
Efficacy	34lm/W	4	3.62	11		
TS1159	I _{max} =983cd/klm	I _{max}	177cd	5	4.52	7

Power supply	Version	Colour	2700K	3000K	4000K
48Vdc	EL.	○	1T6651EL	1T6652EL	1T6653EL
48Vdc	EL.	●	1T6654EL	1T6655EL	1T6656EL
48Vdc	DALI	○	1T6651DA	1T6652DA	1T6653DA
48Vdc	DALI	●	1T6654DA	1T6655DA	1T6656DA



Label 2 long arm

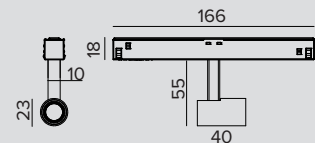

LED / 2,6W / LENS / SP



		3000K	H(m)	D(m)	E _{max} (lx)	
Ra90				13°		
Fixture Power	4W	1	0.23	1419		
Source Flux	180lm	2	0.45	355		
Fixture Flux	152lm	3	0.68	158		
Efficacy	40lm/W	4	0.90	89		
TS1157	I _{max} =7873cd/klm	I _{max}	1419cd	5	1.13	57

Power supply	Version	Colour	2700K	3000K	4000K
48Vdc	EL.	○	1T6693EL	1T6694EL	1T6695EL
48Vdc	EL.	●	1T6696EL	1T6697EL	1T6698EL
48Vdc	DALI	○	1T6693DA	1T6694DA	1T6695DA
48Vdc	DALI	●	1T6696DA	1T6697DA	1T6698DA

LED / 2,6W / LENS / FL



		3000K	H(m)	D(m)	E _{max} (lx)
Ra90				31°	
Fixture Power	4W	1	0.55	346	
Source Flux	180lm	2	1.10	87	
Fixture Flux	136lm	3	1.65	38	
Efficacy	36lm/W	4	2.19	22	
TS1158	I _{max} =1920cd/klm	I _{max}	346cd	5	2.74

Power supply	Version	Colour	2700K	3000K	4000K
48Vdc	EL.	○	1T6699EL	1T6700EL	1T6701EL
48Vdc	EL.	●	1T6702EL	1T6703EL	1T6704EL
48Vdc	DALI	○	1T6699DA	1T6700DA	1T6701DA
48Vdc	DALI	●	1T6702DA	1T6703DA	1T6704DA

LED / 2,6W / LENS / MWFL



		3000K	H(m)	D(m)	E _{max} (lx)
Ra90				49°	
Fixture Power	4W	1	0.90	177	
Source Flux	180lm	2	1.81	44	
Fixture Flux	131lm	3	2.71	20	
Efficacy	34lm/W	4	3.62	11	
TS1159	I _{max} =983cd/klm	I _{max}	177cd	5	4.52

Power supply	Version	Colour	2700K	3000K	4000K
48Vdc	EL.	○	1T6705EL	1T6706EL	1T6707EL
48Vdc	EL.	●	1T6708EL	1T6709EL	1T6710EL
48Vdc	DALI	○	1T6705DA	1T6706DA	1T6707DA
48Vdc	DALI	●	1T6708DA	1T6709DA	1T6710DA



Label 4 short arm

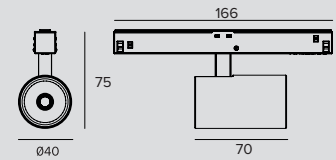

LED / 8W / REFLECTOR / SP

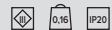

		3000K	H(m)	D(m)	E _{max} (lx)
Ra90				18°	
Fixture Power	9W	1	0.31	4214	
Source Flux	982lm	2	0.62	1053	
Fixture Flux	622lm	3	0.93	468	
Efficacy	71lm/W	4	1.24	263	
TS1072	I _{max} =4291cd/klm	I _{max}	4214cd	5	1.55

Power supply	Version	Colour	2700K	3000K	4000K
48Vdc	EL.	○	1T6657EL	1T6658EL	1T6659EL
48Vdc	EL.	●	1T6660EL	1T6661EL	1T6662EL
48Vdc	DALI	○	1T6657DA	1T6658DA	1T6659DA
48Vdc	DALI	●	1T6660DA	1T6661DA	1T6662DA

LED / 8W / REFLECTOR / FL



		3000K	H(m)	D(m)	E _{max} (lx)
Ra90				27°	
Fixture Power	9W	1	0.48	3199	
Source Flux	1129lm	2	0.95	800	
Fixture Flux	806lm	3	1.43	355	
Efficacy	92lm/W	4	1.91	200	
TS1073	I _{max} =2834cd/klm	I _{max}	3199cd	5	2.38

Power supply	Version	Colour	2700K	3000K	4000K
48Vdc	EL.	○	1T6663EL	1T6664EL	1T6665EL
48Vdc	EL.	●	1T6666EL	1T6667EL	1T6668EL
48Vdc	DALI	○	1T6663DA	1T6664DA	1T6665DA
48Vdc	DALI	●	1T6666DA	1T6667DA	1T6668DA

LED / 8W / REFLECTOR / MWFL



		3000K	H(m)	D(m)	E _{max} (lx)
Ra90				42°	
Fixture Power	9W	1	0.76	1831	
Source Flux	1129lm	2	1.52	458	
Fixture Flux	835lm	3	2.28	203	
Efficacy	95lm/W	4	3.04	114	
TS1074	I _{max} =1622cd/klm	I _{max}	1831cd	5	3.80

Power supply	Version	Colour	2700K	3000K	4000K
48Vdc	EL.	○	1T6669EL	1T6670EL	1T6671EL
48Vdc	EL.	●	1T6672EL	1T6673EL	1T6674EL
48Vdc	DALI	○	1T6669DA	1T6670DA	1T6671DA
48Vdc	DALI	●	1T6672DA	1T6673DA	1T6674DA

FORTYEIGHT



Label 4 long arm

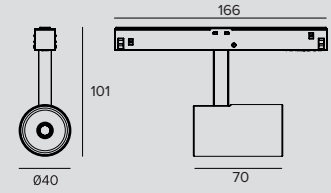

LED / 8W / REFLECTOR / SP											
	3000K	H(m)	D(m)	E _{max} (lx)		Power supply	Version	Colour	2700K	3000K	4000K
	Ra90		18°			48Vdc	EL.	○	1T6711EL	1T6712EL	1T6713EL
	Fixture Power	9W	1	0.31	4214	48Vdc	EL.	●	1T6714EL	1T6715EL	1T6716EL
	Source Flux	982lm	2	0.62	1053	48Vdc	DALI	○	1T6711DA	1T6712DA	1T6713DA
	Fixture Flux	622lm	3	0.93	468	48Vdc	DALI	●	1T6714DA	1T6715DA	1T6716DA
	Efficacy	71lm/W	4	1.24	263						
TS1072	I _{max} =4291cd/klm	I _{max}	4214cd	5	1.55	169					

LED / 8W / REFLECTOR / FL											
	3000K	H(m)	D(m)	E _{max} (lx)		Power supply	Version	Colour	2700K	3000K	4000K
	Ra90		27°			48Vdc	EL.	○	1T6717EL	1T6718EL	1T6719EL
	Fixture Power	9W	1	0.48	3199	48Vdc	EL.	●	1T6720EL	1T6721EL	1T6722EL
	Source Flux	1129lm	2	0.95	800	48Vdc	DALI	○	1T6717DA	1T6718DA	1T6719DA
	Fixture Flux	806lm	3	1.43	355	48Vdc	DALI	●	1T6720DA	1T6721DA	1T6722DA
	Efficacy	92lm/W	4	1.91	200						
TS1073	I _{max} =2834cd/klm	I _{max}	3199cd	5	2.38	128					

LED / 8W / REFLECTOR / MWFL											
	3000K	H(m)	D(m)	E _{max} (lx)		Power supply	Version	Colour	2700K	3000K	4000K
	Ra90		42°			48Vdc	EL.	○	1T6723EL	1T6724EL	1T6725EL
	Fixture Power	9W	1	0.76	1831	48Vdc	EL.	●	1T6726EL	1T6727EL	1T6728EL
	Source Flux	1129lm	2	1.52	458	48Vdc	DALI	○	1T6723DA	1T6724DA	1T6725DA
	Fixture Flux	835lm	3	2.28	203	48Vdc	DALI	●	1T6726DA	1T6727DA	1T6728DA
	Efficacy	95lm/W	4	3.04	114						
TS1074	I _{max} =1622cd/klm	I _{max}	1831cd	5	3.80	73					



Label 6 short arm

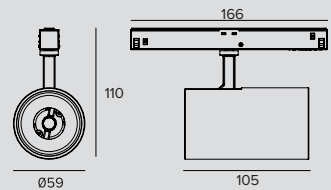

LED / 14W / REFLECTOR / SP											
	3000K	H(m)	D(m)	E _{max} (lx)		Power supply	Version	Colour	2700K	3000K	4000K
	Ra90		16°			48Vdc	EL.	○	1T6675EL	1T6676EL	1T6677EL
	Fixture Power	15W	1	0.28	10741	48Vdc	EL.	●	1T6678EL	1T6679EL	1T6680EL
	Source Flux	1793lm	2	0.55	2685	48Vdc	DALI	○	1T6675DA	1T6676DA	1T6677DA
	Fixture Flux	1316lm	3	0.83	1193	48Vdc	DALI	●	1T6678DA	1T6679DA	1T6680DA
	Efficacy	91lm/W	4	1.11	671						
TS1068	I _{max} =5990cd/klm	I _{max}	10741cd	5	1.39	430					

LED / 14W / REFLECTOR / FL



	3000K	H(m)	D(m)	E _{max} (lx)		
	Ra90		31°			
	Fixture Power	15W	1	0.56	4410	
	Source Flux	1793lm	2	1.12	1102	
	Fixture Flux	1386lm	3	1.67	490	
	Efficacy	96lm/W	4	2.23	276	
TS1069	I _{max} =2460cd/klm	I _{max}	4410cd	5	2.79	176

Power supply	Version	Colour	2700K	3000K	4000K
48Vdc	EL.	○	1T6681EL	1T6682EL	1T6683EL
48Vdc	EL.	●	1T6684EL	1T6685EL	1T6686EL
48Vdc	DALI	○	1T6681DA	1T6682DA	1T6683DA
48Vdc	DALI	●	1T6684DA	1T6685DA	1T6686DA

LED / 14W / REFLECTOR / MWFL



	3000K	H(m)	D(m)	E _{max} (lx)		
	Ra90		48°			
	Fixture Power	15W	1	0.88	2457	
	Source Flux	1793lm	2	1.77	614	
	Fixture Flux	1373lm	3	2.65	273	
	Efficacy	95lm/W	4	3.53	154	
TS1070	I _{max} =1378cd/klm	I _{max}	2471cd	5	4.41	98

Power supply	Version	Colour	2700K	3000K	4000K
48Vdc	EL.	○	1T6687EL	1T6688EL	1T6689EL
48Vdc	EL.	●	1T6690EL	1T6691EL	1T6692EL
48Vdc	DALI	○	1T6687DA	1T6688DA	1T6689DA
48Vdc	DALI	●	1T6690DA	1T6691DA	1T6692DA



Label 6 long arm

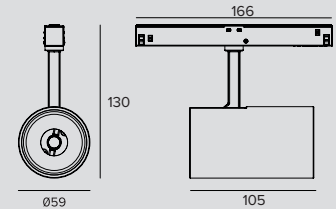

LED / 14W / REFLECTOR / SP

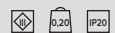

	3000K	H(m)	D(m)	E _{max} (lx)		
	Ra90		16°			
	Fixture Power	15W	1	0.28	10741	
	Source Flux	1793lm	2	0.55	2685	
	Fixture Flux	1316lm	3	0.83	1193	
	Efficacy	91lm/W	4	1.11	671	
TS1068	I _{max} =5990cd/klm	I _{max}	10741cd	5	1.39	430

Power supply	Version	Colour	2700K	3000K	4000K
48Vdc	EL.	○	1T6729EL	1T6730EL	1T6731EL
48Vdc	EL.	●	1T6732EL	1T6733EL	1T6734EL
48Vdc	DALI	○	1T6729DA	1T6730DA	1T6731DA
48Vdc	DALI	●	1T6732DA	1T6733DA	1T6734DA

LED / 14W / REFLECTOR / FL



	3000K	H(m)	D(m)	E _{max} (lx)		
	Ra90		31°			
	Fixture Power	15W	1	0.56	4410	
	Source Flux	1793lm	2	1.12	1102	
	Fixture Flux	1386lm	3	1.67	490	
	Efficacy	96lm/W	4	2.23	276	
TS1069	I _{max} =2460cd/klm	I _{max}	4410cd	5	2.79	176

Power supply	Version	Colour	2700K	3000K	4000K
48Vdc	EL.	○	1T6735EL	1T6736EL	1T6737EL
48Vdc	EL.	●	1T6738EL	1T6739EL	1T6740EL
48Vdc	DALI	○	1T6735DA	1T6736DA	1T6737DA
48Vdc	DALI	●	1T6738DA	1T6739DA	1T6740DA

LED / 14W / REFLECTOR / MWFL



	3000K	H(m)	D(m)	E _{max} (lx)		
	Ra90		48°			
	Fixture Power	15W	1	0.88	2457	
	Source Flux	1793lm	2	1.77	614	
	Fixture Flux	1373lm	3	2.65	273	
	Efficacy	95lm/W	4	3.53	154	
TS1070	I _{max} =1378cd/klm	I _{max}	2471cd	5	4.41	98

Power supply	Version	Colour	2700K	3000K	4000K
48Vdc	EL.	○	1T6741EL	1T6742EL	1T6743EL
48Vdc	EL.	●	1T6744EL	1T6745EL	1T6746EL
48Vdc	DALI	○	1T6741DA	1T6742DA	1T6743DA
48Vdc	DALI	●	1T6744DA	1T6745DA	1T6746DA

FORTYEIGHT

Accessories Label 2

Filter

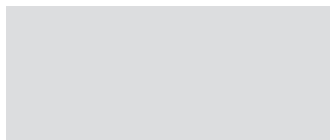

Filter	Ø	Code
Halogen +	17	1T6936
Vivid +	17	1T6937

Art filter.

Flat glass interference filter that can vary the colour parameters of the emission of the fixtures it is applied to.

To be used only with 3000K and Ra80 fixtures.

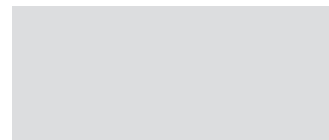

Filter	Ø	Code
Meat	17	1T6932
Fish	17	1T6933
Bread	17	1T6934
Vegetables	17	1T6935

Food filter.

Flat glass interference filter that can vary the colour parameters of the emission of the fixtures it is applied to.



Filter	Ø	Code
Beauty	17	1T6938

Beauty filter.

Flat glass interference filter that can vary the colour parameters of the emission of the fixtures it is applied to.

To be used only with 3000K and Ra80 fixtures.



Filter	Ø	Code
	17	1T6939

Holographic PMMA filter with blade of light effect.

Allows the beam to be made oval; combined with spot and flood optics the effect appears more pronounced.

Accessories Label 4

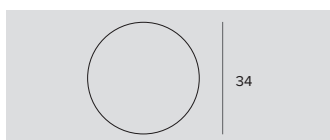

Filter	Ø	Code
Halogen +	34	1T6926
Vivid +	34	1T6927

Art filter.

Flat glass interference filter that can vary the colour parameters of the emission of the fixtures it is applied to.

To be used only with 3000K and Ra80 fixtures.

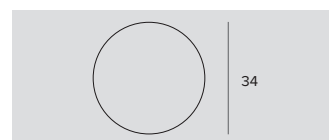

Filter	Ø	Code
Meat	34	1T6922
Fish	34	1T6923
Bread	34	1T6924
Vegetables	34	1T6925

Food filter.

Flat glass interference filter that can vary the colour parameters of the emission of the fixtures it is applied to.

1T6922

To be used only with 3000K and Ra80 fixtures.

1T6923

To be used only with 4000K and Ra80 fixtures.

1T6924

To be used only with 3000K and Ra80 fixtures.

1T6925

To be used only with 3000K and Ra80 fixtures.

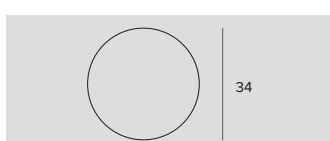

Filter	Ø	Code
Beauty	34	1T6928

Beauty filter.

Flat glass interference filter that can vary the colour parameters of the emission of the fixtures it is applied to.

To be used only with 3000K and Ra80 fixtures.

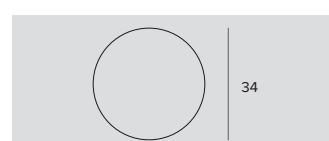

Filter	Ø	Code
	34	1T6931

PMMA holographic filter with blade effect to ovalize the light beam; more evident when combined with spot and flood optics.

Grid

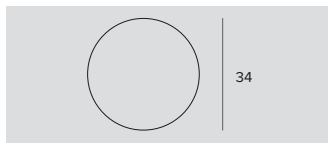

Ø	Code
34	1T6930

Anti-glare louver.
Black painted metal honeycomb structure.
Complete with holographic diffusion filter.

Accessories Label 6

Filter

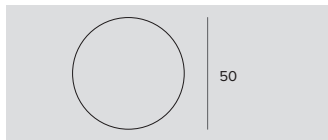

Filter	Ø	Code
Halogen +	50	1T6381
Vivid +	50	1T6383

Art filter.
Flat glass interference filter that can vary the colour parameters of the emission of the fixtures it is applied to.
To be used only with 3000K and Ra80 fixtures.



Filter	Ø	Code
Beauty	50	1T6393

Beauty filter.
Flat glass interference filter that can vary the colour parameters of the emission of the fixtures it is applied to.
To be used only with 3000K and Ra80 fixtures.

Screen

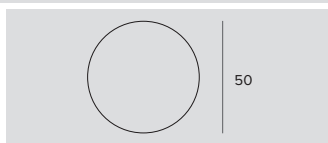

Ø	Code
50	1T6521

Protective screen.

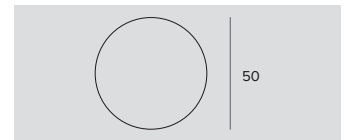

Filter	Ø	Code
Meat	50	1T6385
Fish	50	1T6387
Bread	50	1T6389
Vegetables	50	1T6391

Food filter.
Flat glass interference filter that can vary the colour parameters of the emission of the fixtures it is applied to.
1T6385
To be used only with 3000K and Ra80 fixtures.
1T6387
To be used only with 4000K and Ra80 fixtures.
1T6389
To be used only with 3000K and Ra80 fixtures.
1T6391
To be used only with 3000K and Ra80 fixtures.

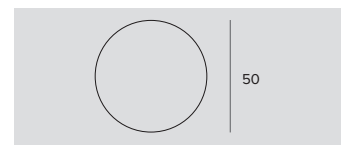

Ø	Code
50	1T4721

PMMA holographic filter with blade effect to ovalize the light beam; more evident when combined with spot and flood optics.

Grid



Ø	Code
50	1T4322

Anti-glare louver.
Black painted metal honeycomb structure.
Complete with holographic diffusion filter.

LOGICO

System

GENERAL INFO

Modules of variable lengths for ceiling, suspension, recessed and semi-recessed installations.

Recessed versions with a flange or trimless.

Lengths:

281mm - 562mm - 1122mm - 1682mm - 3364mm

LED

Linear Board LED Engine for linear and SPOT versions

LED COB for LABEL versions

From 982lm to 28960lm

3000K - 4000K

OPAL, UGR, WW versions: Ra84

Ra90 - To order this version it is necessary to add the suffix "90" at the end of the standard code

SPOT, LABEL versions: Ra90

PRODUCT EFFICACY

Up to 109lm/W

OPTICS

OPAL - UGR - WW - SP - FL - MWFL

POWER SUPPLY

Electronic - DALI

Casambi control: the DALI version is equipped with special accessories.

Emergency on request.

MATERIAL

Powder coated, extruded, calendered aluminium.

Modular lighting system with which it is possible to create luminous shapes and numerous lighting scenes given the different lengths available and T, L, and X light connectors and high-power or low-power lumen on modules of the same length.

It is made up of many lighting units: diffused light, UGR<19 controlled light suitable for the workplace, wall washer and the new spotlight modules with LABEL 4 and LABEL 6 projectors.

The accessories allow it to be installed on the ceiling, suspended, recessed, or semi-recessed (with or without flange).

Also available in a stand alone version.





Zonamerica

Architect
Estudio Dovat
Arquitectos

Lighting Design
Estudio Hofstadter

Photographer
Ferrés - Cánepa

Country
Montevideo,
Uruguay

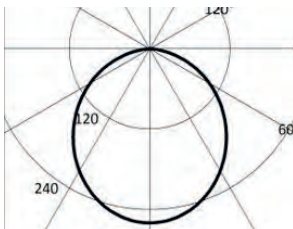
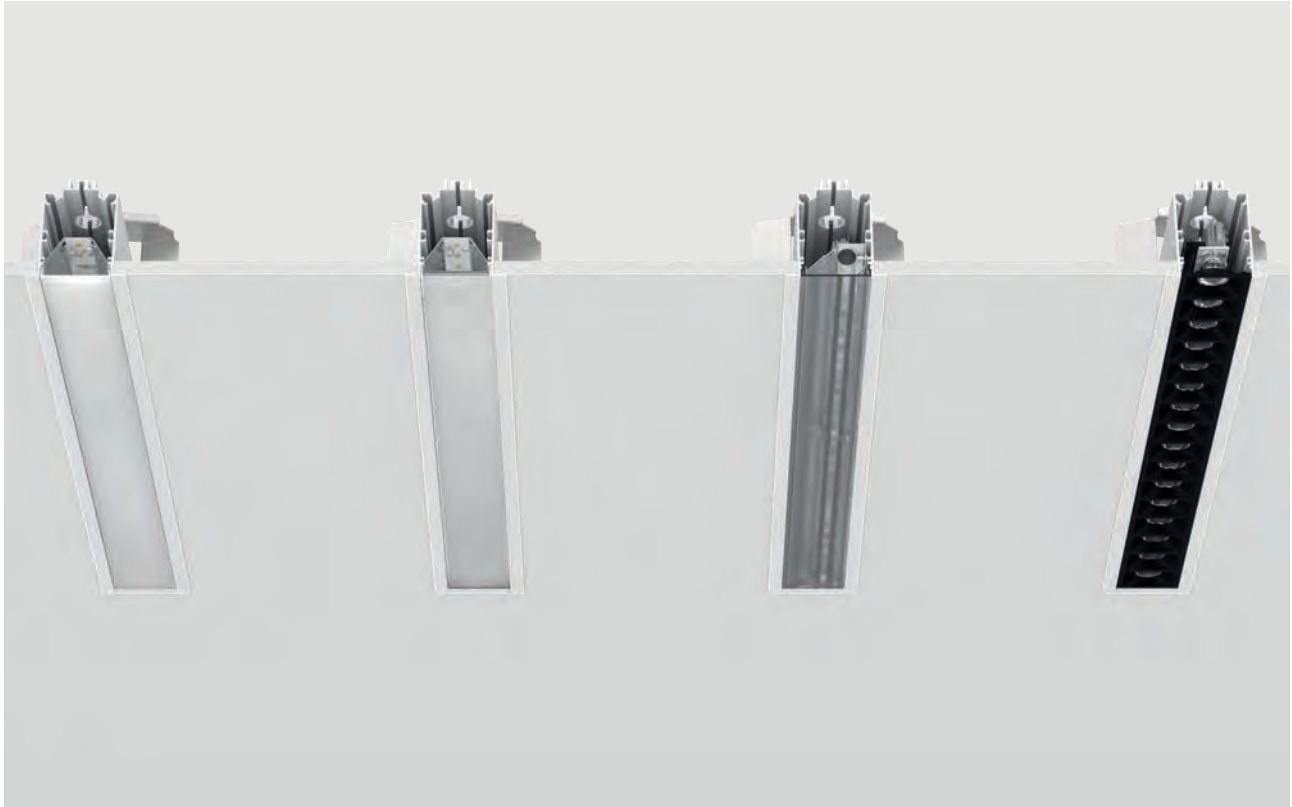

OPAL

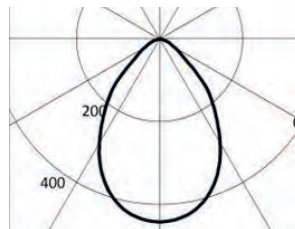

UGR<19

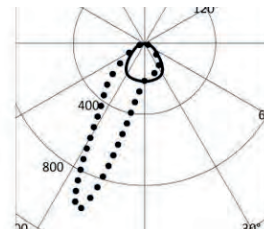

WALL WASHER

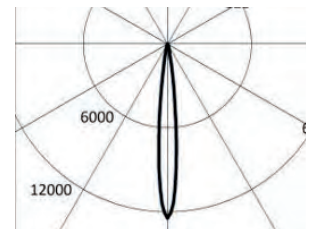

SPOT UGR<7

Four different optical systems

- **Diffused light** with an opal screen: a soft, wide light emission particularly suitable for receptions and communal areas, corridors, etc...
- **Controlled light** UGR<19 with a prismatic screen (only for the direct component): ideal for open space offices, schools or meeting rooms where glare must be reduced to a minimum.
- **Directed light** with a Wall Washer optical system: ideal for lighting vertical surfaces like walls or works of art.
- **Precise light** where a system composed of micro lenses produces precise and focused SPOT effects with UGR<7, ideal for lighting commercial and hotel environments.



Easy to assemble

Each module is already complete with the lighting unit. Modules with linear light snap together or use magnets, so no tools are needed. The new modules with spotlights already have built-in projectors or lighting elements.

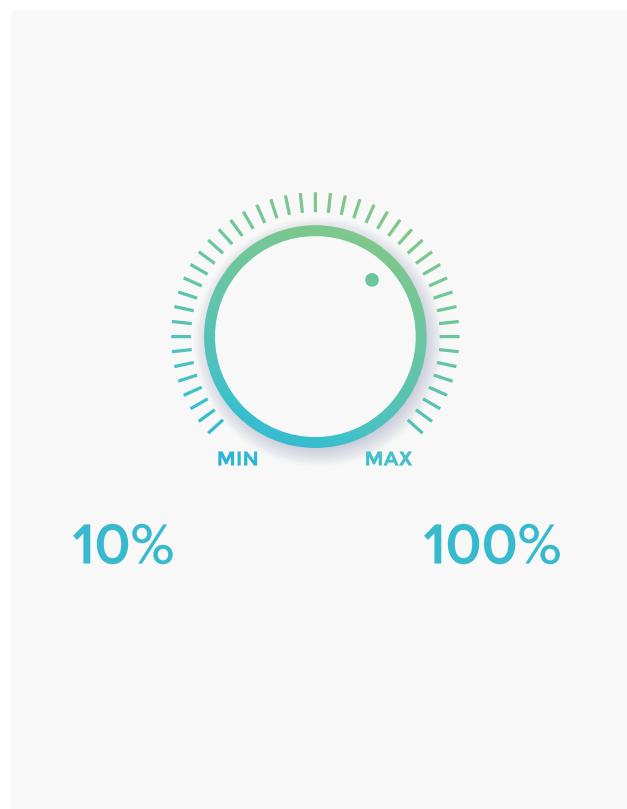

Dimmer light

The LOGIC modules (opal, ugr, asy, Label) equipped with DALI driver can be dimmed from 10% to 100% with AM modulation amplitude.

Dimming is done by modifying the piloting current and not by turning the LEDs on and off. This prevents flickering and makes it suitable for installation even where videos are recorded.

04



05

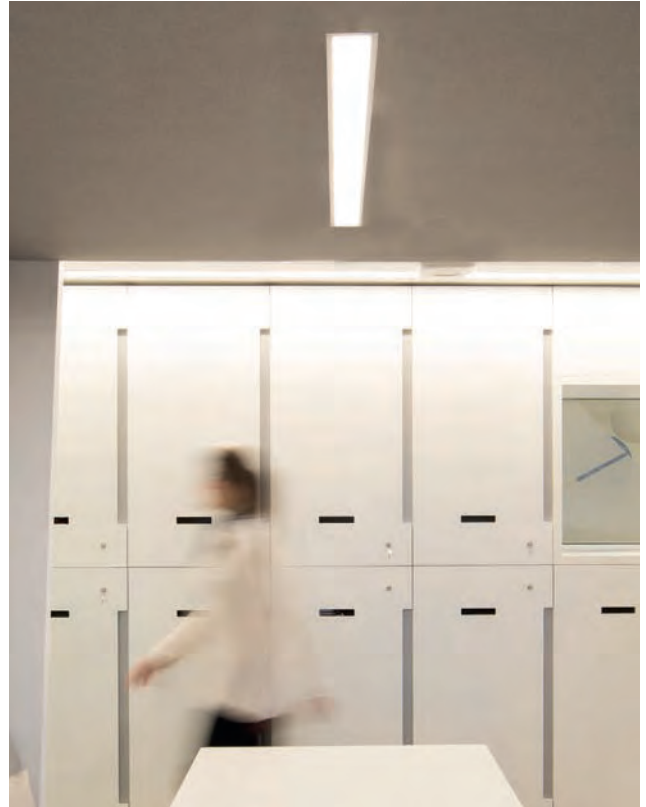

LOGICO trimless recessed

It can be installed recessed or semi-recessed using the same recessing box that can be left with the flange visible or grouted for a trimless effect.

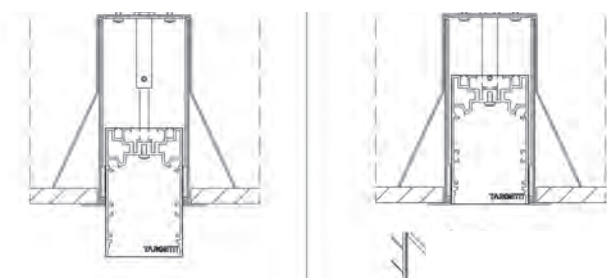

LOGICO recessed with flange

It can be installed without a recessing box, using the bracket accessories. Semi-recessed installation is not available.

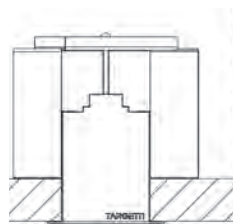



Ceiling installation

The modules must be fixed to the ceiling with the special accessory brackets. The springs are attached to the modules in a "click" by applying pressure.

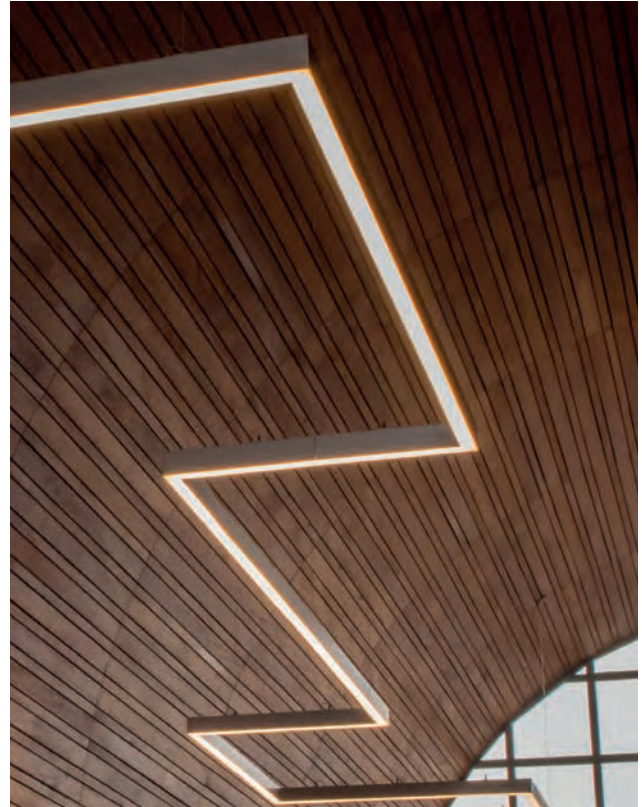
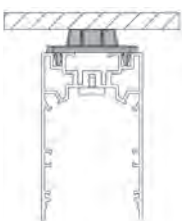

Suspended also on sloping ceilings

The suspension kit allows installation even on tilted ceilings or on vertical elements.

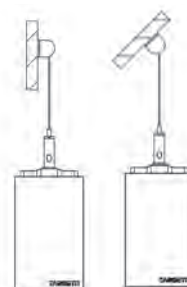



New LABEL modules

New linear modules equipped with LABEL 4 or LABEL 6 projectors, available with spotlights, floodlights, and medium wide floodlights.



New SPOT modules

As of today, LOGICO is also available with the new SPOT modules with LED Lineare High Power card and optical system made up of TIR lenses in optical methacrylate, holographic filter and black polycarbonate frame (the profile finish also comes in white). The result is a highly concentrated and controlled light for scenic effects UGR<7 (EN-12464)

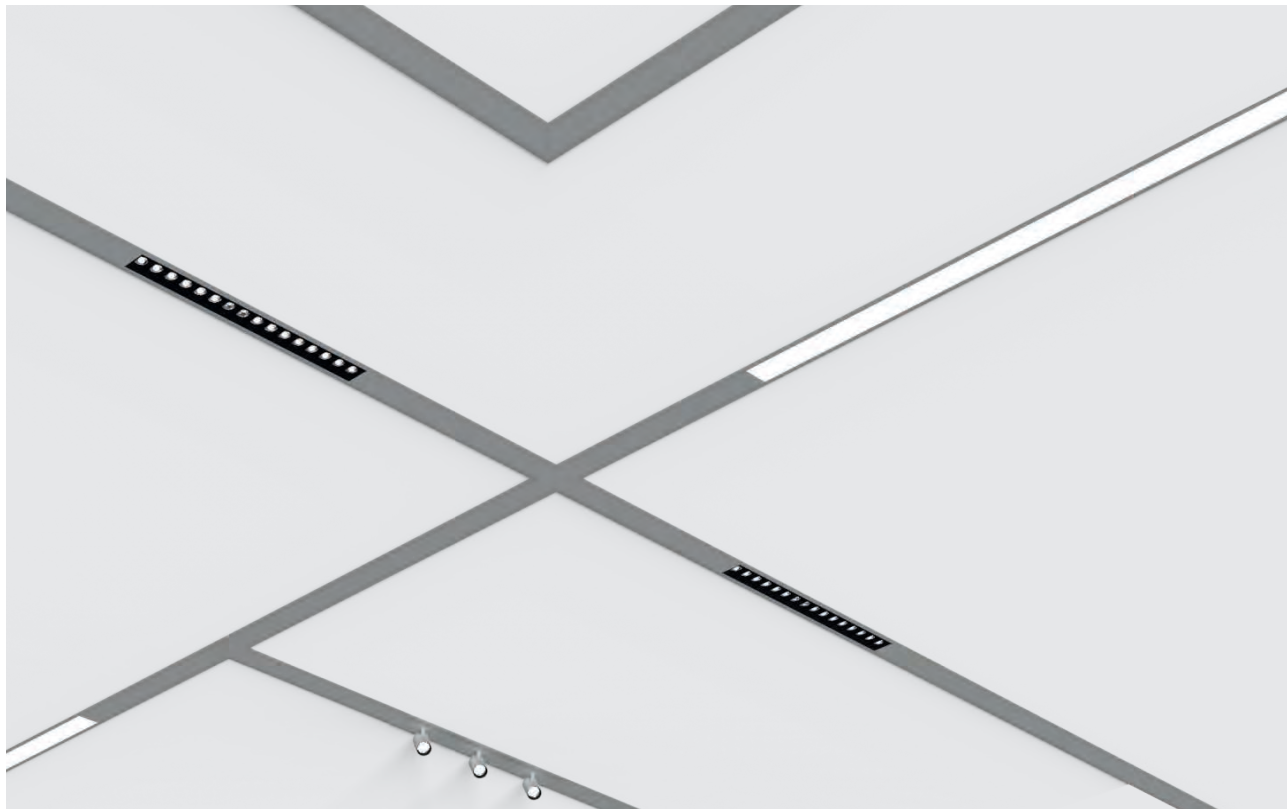

New blind modules

New blind modules to create a continuous system that connects the spaces between them without interruption. Joints without a light unit are also available to guarantee infinite compositional solutions.



System Ceiling/ Suspension - continuous light module L. 562mm

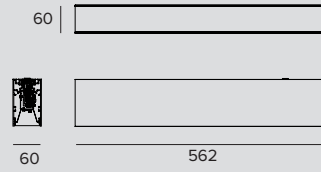

LED / 12W / DOWN OPAL ± 3.6 IP20

		3000K	H(m)	D(m)	Emax(lx)
Ra84				106°	
Fixture Power	14W	1	2.66	451	
Source Flux	1740lm	2	5.33	113	
Fixture Flux	1185lm	3	7.99	50	
Efficacy	85lm/W	4	10.65	28	
TS991	Imax=259cd/klm Imax	451cd	5	13.32	18

Driver	Colour	3000K	4000K
EL.	○	1T6027EL	1T6028EL
EL.	●	1T6031EL	1T6032EL
EL.	●	1T6035EL	1T6036EL
DALI	○	1T6027DA	1T6028DA
DALI	●	1T6031DA	1T6032DA
DALI	●	1T6035DA	1T6036DA

LED / 24W / DOWN OPAL ± 3.6 IP20

		3000K	H(m)	D(m)	Emax(lx)
Ra84				106°	
Fixture Power	27W	1	2.66	892	
Source Flux	3440lm	2	5.33	223	
Fixture Flux	2343lm	3	7.99	99	
Efficacy	87lm/W	4	10.65	56	
TS996	Imax=259cd/klm Imax	892cd	5	13.32	36

Driver	Colour	3000K	4000K
EL.	○	1T6029EL	1T6030EL
EL.	●	1T6033EL	1T6034EL
EL.	●	1T6037EL	1T6038EL
DALI	○	1T6029DA	1T6030DA
DALI	●	1T6033DA	1T6034DA
DALI	●	1T6037DA	1T6038DA

LED / 8W / DOWN UGR ± 3.6 IP20

		3000K	H(m)	D(m)	Emax(lx)
Ra84				74°	
Fixture Power	9W	1	1.51	556	
Source Flux	1260lm	2	3.02	139	
Fixture Flux	816lm	3	4.52	62	
Efficacy	91lm/W	4	6.03	35	
TS992	Imax=442cd/klm Imax	556cd	5	7.54	22

Driver	Colour	3000K	4000K
EL.	○	1T6825EL	1T6826EL
EL.	●	1T6827EL	1T6828EL
EL.	●	1T6829EL	1T6830EL
DALI	○	1T6825DA	1T6826DA
DALI	●	1T6827DA	1T6828DA
DALI	●	1T6829DA	1T6830DA

LED / 12W / DOWN WW ± 3.6 IP20

		3000K	H(m)	D1(m)	D2(m)	Emax(lx)
Ra84				97°	101°	
Fixture Power	14W	1	2.28	2.55	1400	
Source Flux	1740lm	2	4.56	5.10	350	
Fixture Flux	1369lm	3	6.84	7.64	156	
Efficacy	98lm/W	4	9.12	10.19	88	
TS993	Imax=1001cd/klm Imax	1743cd	5	11.40	12.74	56

Driver	Colour	3000K	4000K
EL.	○	1T6837EL	1T6838EL
EL.	●	1T6839EL	1T6840EL
EL.	●	1T6841EL	1T6842EL
DALI	○	1T6837DA	1T6838DA
DALI	●	1T6839DA	1T6840DA
DALI	●	1T6841DA	1T6842DA

LED / 24W / DOWN WW ± 3.6 IP20

		3000K	H(m)	D1(m)	D2(m)	Emax(lx)
Ra84				97°	101°	
Fixture Power	27W	1	2.28	2.55	2768	
Source Flux	3440lm	2	4.56	5.10	692	
Fixture Flux	2707lm	3	6.84	7.64	308	
Efficacy	100lm/W	4	9.12	10.19	173	
TS997	Imax=1001cd/klm Imax	3445cd	5	11.40	12.74	111

Driver	Colour	3000K	4000K
EL.	○	1T6843EL	1T6844EL
EL.	●	1T6845EL	1T6846EL
EL.	●	1T6847EL	1T6848EL
DALI	○	1T6843DA	1T6844DA
DALI	●	1T6845DA	1T6846DA
DALI	●	1T6847DA	1T6848DA

LED / 18W / UP-DOWN OPAL



		3000K	H(m)	D(m)	E _{max} (lx)
Ra84				106°	
Fixture Power	20W	1	2.66	387	
Source Flux	2610lm	2	5.33	97	
Fixture Flux	1773lm	3	7.99	43	
Efficacy	89lm/W	4	10.65	24	
TS994	I _{max} =148cd/klm	I _{max}	387cd	5	13.32

Driver	Colour	3000K	4000K
EL.	○	1T6039EL	1T6040EL
EL.	●	1T6043EL	1T6044EL
EL.	●	1T6047EL	1T6048EL
DALI	○	1T6039DA	1T6040DA
DALI	●	1T6043DA	1T6044DA
DALI	●	1T6047DA	1T6048DA

LED / 30W / UP-DOWN OPAL



		3000K	H(m)	D(m)	E _{max} (lx)
Ra84				106°	
Fixture Power	34W	1	2.66	810	
Source Flux	4310lm	2	5.33	203	
Fixture Flux	2930lm	3	7.99	90	
Efficacy	86lm/W	4	10.65	51	
TS998	I _{max} =188cd/klm	I _{max}	810cd	5	13.32

Driver	Colour	3000K	4000K
EL.	○	1T6041EL	1T6042EL
EL.	●	1T6045EL	1T6046EL
EL.	●	1T6049EL	1T6050EL
DALI	○	1T6041DA	1T6042DA
DALI	●	1T6045DA	1T6046DA
DALI	●	1T6049DA	1T6050DA

LED / 12W / UP-DOWN UGR



		3000K	H(m)	D(m)	E _{max} (lx)
Ra84				74°	
Fixture Power	14W	1	1.51	477	
Source Flux	1890lm	2	3.02	119	
Fixture Flux	1248lm	3	4.52	53	
Efficacy	89lm/W	4	6.03	30	
TS995	I _{max} =252cd/klm	I _{max}	477cd	5	7.54

Driver	Colour	3000K	4000K
EL.	○	1T6831EL	1T6832EL
EL.	●	1T6833EL	1T6834EL
EL.	●	1T6835EL	1T6836EL
DALI	○	1T6831DA	1T6832DA
DALI	●	1T6833DA	1T6834DA
DALI	●	1T6835DA	1T6836DA



System Ceiling/
Suspension - continuous
light module L. 1122mm

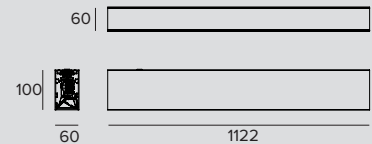

LED / 24W / DOWN OPAL



		3000K	H(m)	D(m)	E _{max} (lx)
Ra84				106°	
Fixture Power	27W	1	2.66	903	
Source Flux	3480lm	2	5.33	226	
Fixture Flux	2370lm	3	7.99	100	
Efficacy	88lm/W	4	10.65	56	
TS991	I _{max} =259cd/klm	I _{max}	903cd	5	13.32

Driver	Colour	3000K	4000K
EL.	○	1T5635EL	1T5636EL
EL.	●	1T5639EL	1T5640EL
EL.	●	1T5637EL	1T5638EL
DALI	○	1T5635DA	1T5636DA
DALI	●	1T5639DA	1T5640DA
DALI	●	1T5637DA	1T5638DA

LED / 48W / DOWN OPAL



		3000K	H(m)	D(m)	E _{max} (lx)
Ra84				106°	
Fixture Power	54W	1	2.66	1785	
Source Flux	6880lm	2	5.33	446	
Fixture Flux	4685lm	3	7.99	198	
Efficacy	87lm/W	4	10.65	112	
TS996	I _{max} =259cd/klm	I _{max}	1785cd	5	13.32

Driver	Colour	3000K	4000K
EL.	○	1T5641EL	1T5642EL
EL.	●	1T5645EL	1T5646EL
EL.	●	1T5643EL	1T5644EL
DALI	○	1T5641DA	1T5642DA
DALI	●	1T5645DA	1T5646DA
DALI	●	1T5643DA	1T5644DA

LOGICO

LED / 16W / DOWN UGR



		3000K	H(m)	D(m)	E _{max} (lx)	
Ra84				74°		
Fixture Power	18W	1	1.51	1113		
Source Flux	2520lm	2	3.02	278		
Fixture Flux	1631lm	3	4.52	124		
Efficacy	91lm/W	4	6.03	70		
TS992	I _{max} =442cd/klm	I _{max}	1113cd	5	7.54	45

Driver	Colour	3000K	4000K
EL.	○	1T5659EL	1T5660EL
EL.	●	1T5663EL	1T5664EL
EL.	●	1T5661EL	1T5662EL
DALI	○	1T5659DA	1T5660DA
DALI	●	1T5663DA	1T5664DA
DALI	●	1T5661DA	1T5662DA

LED / 24W / DOWN WW



		3000K	H(m)	D1(m)	D2(m)	E _{max} (lx)	
Ra84				97°	101°		
Fixture Power	27W	1	2.28	2.55	2801		
Source Flux	3480lm	2	4.56	5.10	700		
Fixture Flux	2739lm	3	6.84	7.64	311		
Efficacy	101lm/W	4	9.12	10.19	175		
TS993	I _{max} =1001cd/klm	I _{max}	3485cd	5	11.40	12.74	112

Driver	Colour	3000K	4000K
EL.	○	1T5671EL	1T5672EL
EL.	●	1T5675EL	1T5676EL
EL.	●	1T5673EL	1T5674EL
DALI	○	1T5671DA	1T5672DA
DALI	●	1T5675DA	1T5676DA
DALI	●	1T5673DA	1T5674DA

LED / 48W / DOWN WW



		3000K	H(m)	D1(m)	D2(m)	E _{max} (lx)	
Ra84				97°	101°		
Fixture Power	54W	1	2.28	2.55	5537		
Source Flux	6880lm	2	4.56	5.10	1384		
Fixture Flux	5415lm	3	6.84	7.64	615		
Efficacy	100lm/W	4	9.12	10.19	346		
TS997	I _{max} =1001cd/klm	I _{max}	6890cd	5	11.40	12.74	221

Driver	Colour	3000K	4000K
EL.	○	1T5677EL	1T5678EL
EL.	●	1T5681EL	1T5682EL
EL.	●	1T5679EL	1T5680EL
DALI	○	1T5677DA	1T5678DA
DALI	●	1T5681DA	1T5682DA
DALI	●	1T5679DA	1T5680DA

LED / 42W / UP-DOWN OPAL



		3000K	H(m)	D(m)	E _{max} (lx)	
Ra84				106°		
Fixture Power	47W	1	2.66	903		
Source Flux	6090lm	2	5.33	226		
Fixture Flux	4136lm	3	7.99	100		
Efficacy	88lm/W	4	10.65	56		
TS994	I _{max} =148cd/klm	I _{max}	903cd	5	13.32	36

Driver	Colour	3000K	4000K
EL.	○	1T5647EL	1T5648EL
EL.	●	1T5651EL	1T5652EL
EL.	●	1T5649EL	1T5650EL
DALI	○	1T5647DA	1T5648DA
DALI	●	1T5651DA	1T5652DA
DALI	●	1T5649DA	1T5650DA

LED / 66W / UP-DOWN OPAL



		3000K	H(m)	D(m)	E _{max} (lx)	
Ra84				106°		
Fixture Power	74W	1	2.66	1785		
Source Flux	9490lm	2	5.33	446		
Fixture Flux	6452lm	3	7.99	198		
Efficacy	87lm/W	4	10.65	112		
TS998	I _{max} =188cd/klm	I _{max}	1785cd	5	13.32	71

Driver	Colour	3000K	4000K
EL.	○	1T5653EL	1T5654EL
EL.	●	1T5657EL	1T5658EL
EL.	●	1T5655EL	1T5656EL
DALI	○	1T5653DA	1T5654DA
DALI	●	1T5657DA	1T5658DA
DALI	●	1T5655DA	1T5656DA

LED / 28W / UP-DOWN UGR



		3000K	H(m)	D(m)	E _{max} (lx)	
Ra84				74°		
Fixture Power	32W	1	1.51	1113		
Source Flux	4410lm	2	3.02	278		
Fixture Flux	2912lm	3	4.52	124		
Efficacy	91lm/W	4	6.03	70		
TS995	I _{max} =252cd/klm	I _{max}	1113cd	5	7.54	45

Driver	Colour	3000K	4000K
EL.	○	1T5665EL	1T5666EL
EL.	●	1T5669EL	1T5670EL
EL.	●	1T5667EL	1T5668EL
DALI	○	1T5665DA	1T5666DA
DALI	●	1T5669DA	1T5670DA
DALI	●	1T5667DA	1T5668DA



System Ceiling/ Suspension continuous light module L. 1682mm

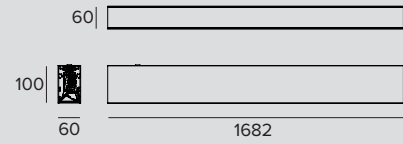

LED / 36W / DOWN OPAL



		3000K	H(m)	D(m)	E _{max} (lx)
		Ra84		106°	
Fixture Power	40W	1	2.66	1354	
Source Flux	5220lm	2	5.33	338	
Fixture Flux	3555lm	3	7.99	150	
Efficacy	89lm/W	4	10.65	85	
TS991	l _{max} =259cd/klm	l _{max}	1354cd	5	13.32
					54

Driver	Colour	3000K	4000K
EL.	○	1T5683EL	1T5684EL
EL.	●	1T5687EL	1T5688EL
EL.	●	1T5685EL	1T5686EL
DALI	○	1T5683DA	1T5684DA
DALI	●	1T5687DA	1T5688DA
DALI	●	1T5685DA	1T5686DA

LED / 72W / DOWN OPAL



		3000K	H(m)	D(m)	E _{max} (lx)
		Ra84		106°	
Fixture Power	81W	1	2.66	2677	
Source Flux	10320lm	2	5.33	669	
Fixture Flux	7028lm	3	7.99	297	
Efficacy	87lm/W	4	10.65	167	
TS996	l _{max} =259cd/klm	l _{max}	2677cd	5	13.32
					107

Driver	Colour	3000K	4000K
EL.	○	1T5689EL	1T5690EL
EL.	●	1T5693EL	1T5694EL
EL.	●	1T5691EL	1T5692EL
DALI	○	1T5689DA	1T5690DA
DALI	●	1T5693DA	1T5694DA
DALI	●	1T5691DA	1T5692DA

LED / 24W / DOWN UGR



		3000K	H(m)	D(m)	E _{max} (lx)
		Ra84		74°	
Fixture Power	27W	1	1.51	1669	
Source Flux	3780lm	2	3.02	417	
Fixture Flux	2447lm	3	4.52	185	
Efficacy	91lm/W	4	6.03	104	
TS992	l _{max} =442cd/klm	l _{max}	1669cd	5	7.54
					67

Driver	Colour	3000K	4000K
EL.	○	1T5707EL	1T5708EL
EL.	●	1T5711EL	1T5712EL
EL.	●	1T5709EL	1T5710EL
DALI	○	1T5707DA	1T5708DA
DALI	●	1T5711DA	1T5712DA
DALI	●	1T5709DA	1T5710DA

LED / 36W / DOWN WW



		3000K	H(m)	D1(m)	D2(m)	E _{max} (lx)
		Ra84		97°	101°	
Fixture Power	40W	1	2.28	2.55	4201	
Source Flux	5220lm	2	4.56	5.10	1050	
Fixture Flux	4108lm	3	6.84	7.64	467	
Efficacy	103lm/W	4	9.12	10.19	263	
TS993	l _{max} =1001cd/klm	l _{max}	5228cd	5	11.40	
					12.74	
					168	

Driver	Colour	3000K	4000K
EL.	○	1T5719EL	1T5720EL
EL.	●	1T5723EL	1T5724EL
EL.	●	1T5721EL	1T5722EL
DALI	○	1T5719DA	1T5720DA
DALI	●	1T5723DA	1T5724DA
DALI	●	1T5721DA	1T5722DA

LED / 72W / DOWN WW



		3000K	H(m)	D1(m)	D2(m)	E _{max} (lx)
		Ra84		97°	101°	
Fixture Power	81W	1	2.28	2.55	8305	
Source Flux	10320lm	2	4.56	5.10	2076	
Fixture Flux	8122lm	3	6.84	7.64	923	
Efficacy	100lm/W	4	9.12	10.19	519	
TS997	l _{max} =1001cd/klm	l _{max}	10335cd	5	11.40	
					12.74	
					332	

Driver	Colour	3000K	4000K
EL.	○	1T5725EL	1T5726EL
EL.	●	1T5729EL	1T5730EL
EL.	●	1T5727EL	1T5728EL
DALI	○	1T5725DA	1T5726DA
DALI	●	1T5729DA	1T5730DA
DALI	●	1T5727DA	1T5728DA

LED / 60W / UP-DOWN OPAL



		3000K	H(m)	D(m)	E _{max} (lx)
Ra84				106°	
Fixture Power	68W	1	2.66	1290	
Source Flux	8700lm	2	5.33	322	
Fixture Flux	5909lm	3	7.99	143	
Efficacy	87lm/W	4	10.65	81	
TS994	I _{max} =148cd/klm	I _{max}	1290cd	5	13.32
				52	

Driver	Colour	3000K	4000K
EL.	○	1T5695EL	1T5696EL
EL.	●	1T5699EL	1T5700EL
EL.	●	1T5697EL	1T5698EL
DALI	○	1T5695DA	1T5696DA
DALI	●	1T5699DA	1T5700DA
DALI	●	1T5697DA	1T5698DA

LED / 96W / UP-DOWN OPAL



		3000K	H(m)	D(m)	E _{max} (lx)
Ra84				106°	
Fixture Power	107W	1	2.66	2595	
Source Flux	13800lm	2	5.33	649	
Fixture Flux	9382lm	3	7.99	288	
Efficacy	88lm/W	4	10.65	162	
TS998	I _{max} =188cd/klm	I _{max}	2595cd	5	13.32
				104	

Driver	Colour	3000K	4000K
EL.	○	1T5701EL	1T5702EL
EL.	●	1T5705EL	1T5706EL
EL.	●	1T5703EL	1T5704EL
DALI	○	1T5701DA	1T5702DA
DALI	●	1T5705DA	1T5706DA
DALI	●	1T5703DA	1T5704DA

LED / 40W / UP-DOWN UGR



		3000K	H(m)	D(m)	E _{max} (lx)
Ra84				74°	
Fixture Power	45W	1	1.51	1590	
Source Flux	6300lm	2	3.02	398	
Fixture Flux	4160lm	3	4.52	177	
Efficacy	92lm/W	4	6.03	99	
TS995	I _{max} =252cd/klm	I _{max}	1590cd	5	7.54
				64	

Driver	Colour	3000K	4000K
EL.	○	1T5713EL	1T5714EL
EL.	●	1T5717EL	1T5718EL
EL.	●	1T5715EL	1T5716EL
DALI	○	1T5713DA	1T5714DA
DALI	●	1T5717DA	1T5718DA
DALI	●	1T5715DA	1T5716DA



**System Ceiling/
Suspension
continuous light
module L. 3364mm**

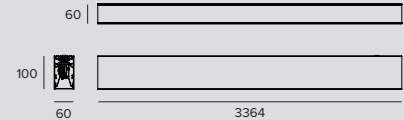

LED / 72W / DOWN OPAL



		3000K	H(m)	D(m)	E _{max} (lx)
Ra84				106°	
Fixture Power	81W	1	2.66	2708	
Source Flux	10440lm	2	5.33	677	
Fixture Flux	7110lm	3	7.99	301	
Efficacy	88lm/W	4	10.65	169	
TS991	I _{max} =259cd/klm	I _{max}	2708cd	5	13.32
				108	

Driver	Colour	3000K	4000K
EL.	○	1T5731EL	1T5732EL
EL.	●	1T5735EL	1T5736EL
EL.	●	1T5733EL	1T5734EL
DALI	○	1T5731DA	1T5732DA
DALI	●	1T5735DA	1T5736DA
DALI	●	1T5733DA	1T5734DA

LED / 144W / DOWN OPAL



		3000K	H(m)	D(m)	E _{max} (lx)
Ra84				106°	
Fixture Power	163W	1	2.66	5354	
Source Flux	20640lm	2	5.33	1338	
Fixture Flux	14056lm	3	7.99	595	
Efficacy	86lm/W	4	10.65	335	
TS996	I _{max} =259cd/klm	I _{max}	5354cd	5	13.32
				214	

Driver	Colour	3000K	4000K
EL.	○	1T5737EL	1T5738EL
EL.	●	1T5741EL	1T5742EL
EL.	●	1T5739EL	1T5740EL
DALI	○	1T5737DA	1T5738DA
DALI	●	1T5741DA	1T5742DA
DALI	●	1T5739DA	1T5740DA

LED / 48W / DOWN UGR



	3000K	H(m)	D(m)	E _{max} (lx)		
	Ra84		74°			
	Fixture Power	54W	1	1.51	3338	
	Source Flux	7560lm	2	3.02	834	
	Fixture Flux	4894lm	3	4.52	371	
	Efficacy	91lm/W	4	6.03	209	
TS992	I _{max} =442cd/klm	I _{max}	3338cd	5	7.54	134

Driver	Colour	3000K	4000K
EL.	○	1T5755EL	1T5756EL
EL.	●	1T5759EL	1T5760EL
EL.	●	1T5757EL	1T5758EL
DALI	○	1T5755DA	1T5756DA
DALI	●	1T5759DA	1T5760DA
DALI	●	1T5757DA	1T5758DA

LED / 72W / DOWN WW



	3000K	H(m)	D1(m)	D2(m)	E _{max} (lx)		
	Ra84		97°	101°			
	Fixture Power	81W	1	2.28	2.55	8402	
	Source Flux	10440lm	2	4.56	5.10	2101	
	Fixture Flux	8216lm	3	6.84	7.64	934	
	Efficacy	101lm/W	4	9.12	10.19	525	
TS993	I _{max} =1001cd/klm	I _{max}	1045cd	5	11.40	12.74	336

Driver	Colour	3000K	4000K
EL.	○	1T5767EL	1T5768EL
EL.	●	1T5771EL	1T5772EL
EL.	●	1T5769EL	1T5770EL
DALI	○	1T5767DA	1T5768DA
DALI	●	1T5771DA	1T5772DA
DALI	●	1T5769DA	1T5770DA

LED / 144W / DOWN WW



	3000K	H(m)	D1(m)	D2(m)	E _{max} (lx)		
	Ra84		97°	101°			
	Fixture Power	163W	1	2.28	2.55	16611	
	Source Flux	20640lm	2	4.56	5.10	4153	
	Fixture Flux	16244lm	3	6.84	7.64	1846	
	Efficacy	100lm/W	4	9.12	10.19	1038	
TS997	I _{max} =1001cd/klm	I _{max}	20670cd	5	11.40	12.74	664

Driver	Colour	3000K	4000K
EL.	○	1T5773EL	1T5774EL
EL.	●	1T5777EL	1T5778EL
EL.	●	1T5775EL	1T5776EL
DALI	○	1T5773DA	1T5774DA
DALI	●	1T5777DA	1T5778DA
DALI	●	1T5775DA	1T5776DA

LED / 120W / UP-DOWN OPAL



	3000K	H(m)	D(m)	E _{max} (lx)		
	Ra84		106°			
	Fixture Power	136W	1	2.66	2579	
	Source Flux	17400lm	2	5.33	645	
	Fixture Flux	11818lm	3	7.99	287	
	Efficacy	87lm/W	4	10.65	161	
TS994	I _{max} =148cd/klm	I _{max}	2579cd	5	13.32	103

Driver	Colour	3000K	4000K
EL.	○	1T5743EL	1T5744EL
EL.	●	1T5747EL	1T5748EL
EL.	●	1T5745EL	1T5746EL
DALI	○	1T5743DA	1T5744DA
DALI	●	1T5747DA	1T5748DA
DALI	●	1T5745DA	1T5746DA

LED / 192W / UP-DOWN OPAL



	3000K	H(m)	D(m)	E _{max} (lx)		
	Ra84		106°			
	Fixture Power	218W	1	2.66	5183	
	Source Flux	27560lm	2	5.33	1296	
	Fixture Flux	18736lm	3	7.99	576	
	Efficacy	86lm/W	4	10.65	324	
TS998	I _{max} =188cd/klm	I _{max}	5183cd	5	13.32	207

Driver	Colour	3000K	4000K
EL.	○	1T5749EL	1T5750EL
EL.	●	1T5753EL	1T5754EL
EL.	●	1T5751EL	1T5752EL
DALI	○	1T5749DA	1T5750DA
DALI	●	1T5753DA	1T5754DA
DALI	●	1T5751DA	1T5752DA

LED / 80W / UP-DOWN UGR



	3000K	H(m)	D(m)	E _{max} (lx)		
	Ra84		74°			
	Fixture Power	91W	1	1.51	3181	
	Source Flux	12800lm	2	3.02	795	
	Fixture Flux	8320lm	3	4.52	353	
	Efficacy	91lm/W	4	6.03	199	
TS995	I _{max} =252cd/klm	I _{max}	3181cd	5	7.54	127

Driver	Colour	3000K	4000K
EL.	○	1T5761EL	1T5762EL
EL.	●	1T5765EL	1T5766EL
EL.	●	1T5763EL	1T5764EL
DALI	○	1T5761DA	1T5762DA
DALI	●	1T5765DA	1T5766DA
DALI	●	1T5763DA	1T5764DA



System Ceiling/ Suspension - continuous light module L connector

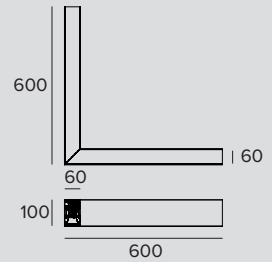

LED / 24W / DOWN OPAL



		3000K	H(m)	D(m)	Emax(lx)	
		Ra84		106°		
Fixture Power	27W	1	2.66	903		
Source Flux	3480lm	2	5.33	226		
Fixture Flux	2370lm	3	7.99	100		
Efficacy	88lm/W	4	10.65	56		
TS991	Imax=259cd/klm	Imax	903cd	5	13.32	36

Driver	Colour	3000K	4000K
EL.	○	1T5976EL	1T5977EL
EL.	●	1T5980EL	1T5981EL
EL.	◐	1T5984EL	1T5985EL
DALI	○	1T5976DA	1T5977DA
DALI	●	1T5980DA	1T5981DA
DALI	◐	1T5984DA	1T5985DA

LED / 48W / DOWN OPAL



		3000K	H(m)	D(m)	Emax(lx)	
		Ra84		106°		
Fixture Power	54W	1	2.66	1785		
Source Flux	6880lm	2	5.33	446		
Fixture Flux	4685lm	3	7.99	198		
Efficacy	87lm/W	4	10.65	112		
TS996	Imax=259cd/klm	Imax	1785cd	5	13.32	71

Driver	Colour	3000K	4000K
EL.	○	1T5978EL	1T5979EL
EL.	●	1T5982EL	1T5983EL
EL.	◐	1T5986EL	1T5987EL
DALI	○	1T5978DA	1T5979DA
DALI	●	1T5982DA	1T5983DA
DALI	◐	1T5986DA	1T5987DA

LED / 16W / DOWN UGR



		3000K	H(m)	D(m)	Emax(lx)	
		Ra84		74°		
Fixture Power	18W	1	1.51	1113		
Source Flux	2520lm	2	3.02	278		
Fixture Flux	1631lm	3	4.52	124		
Efficacy	91lm/W	4	6.03	70		
TS992	Imax=442cd/klm	Imax	1113cd	5	7.54	45

Driver	Colour	3000K	4000K
EL.	○	1T6855EL	1T6856EL
EL.	●	1T6857EL	1T6858EL
EL.	◐	1T6859EL	1T6860EL
DALI	○	1T6855DA	1T6856DA
DALI	●	1T6857DA	1T6858DA
DALI	◐	1T6859DA	1T6860DA

LED / 36W / UP-DOWN OPAL



		3000K	H(m)	D(m)	Emax(lx)	
		Ra84		106°		
Fixture Power	40W	1	2.66	774		
Source Flux	5220lm	2	5.33	193		
Fixture Flux	3545lm	3	7.99	86		
Efficacy	89lm/W	4	10.65	48		
TS994	Imax=148cd/klm	Imax	774cd	5	13.32	31

Driver	Colour	3000K	4000K
EL.	○	1T6891EL	1T6892EL
EL.	●	1T6893EL	1T6894EL
EL.	◐	1T6895EL	1T6896EL
DALI	○	1T6891DA	1T6892DA
DALI	●	1T6893DA	1T6894DA
DALI	◐	1T6895DA	1T6896DA

LED / 24W / UP-DOWN UGR



		3000K	H(m)	D(m)	Emax(lx)	
		Ra84		74°		
Fixture Power	27W	1	1.51	954		
Source Flux	3780lm	2	3.02	239		
Fixture Flux	2496lm	3	4.52	106		
Efficacy	92lm/W	4	6.03	60		
TS995	Imax=252cd/klm	Imax	954cd	5	7.54	38

Driver	Colour	3000K	4000K
EL.	○	1T6873EL	1T6874EL
EL.	●	1T6875EL	1T6876EL
EL.	◐	1T6877EL	1T6878EL
DALI	○	1T6873DA	1T6874DA
DALI	●	1T6875DA	1T6876DA
DALI	◐	1T6877DA	1T6878DA



System Ceiling/ Suspension - continuous light module T connector

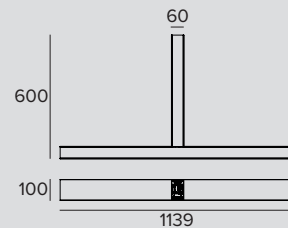

LED / 36W / DOWN OPAL ± 6,7 IP20

		3000K	H(m)	D(m)	Emax(lx)
		Ra84		106°	
Fixture Power	40W	1	2.66	1354	
Source Flux	5220lm	2	5.33	338	
Fixture Flux	3555lm	3	7.99	150	
Efficacy	89lm/W	4	10.65	85	
TS991	Imax=259cd/klm	Imax	1354cd	5	13.32
					54

Driver	Colour	3000K	4000K
EL.	○	1T5988EL	1T5989EL
EL.	●	1T5992EL	1T5993EL
EL.	◐	1T5996EL	1T5997EL
DALI	○	1T5988DA	1T5989DA
DALI	●	1T5992DA	1T5993DA
DALI	◐	1T5996DA	1T5997DA

LED / 72W / DOWN OPAL ± 6,7 IP20

		3000K	H(m)	D(m)	Emax(lx)
		Ra84		106°	
Fixture Power	81W	1	2.66	2677	
Source Flux	10320lm	2	5.33	669	
Fixture Flux	7028lm	3	7.99	297	
Efficacy	87lm/W	4	10.65	167	
TS996	Imax=259cd/klm	Imax	2677cd	5	13.32
					107

Driver	Colour	3000K	4000K
EL.	○	1T5990EL	1T5991EL
EL.	●	1T5994EL	1T5995EL
EL.	◐	1T5998EL	1T5999EL
DALI	○	1T5990DA	1T5991DA
DALI	●	1T5994DA	1T5995DA
DALI	◐	1T5998DA	1T5999DA

LED / 24W / DOWN UGR ± 6,7 IP20

		3000K	H(m)	D(m)	Emax(lx)
		Ra84		74°	
Fixture Power	27W	1	1.51	1669	
Source Flux	3780lm	2	3.02	417	
Fixture Flux	2447lm	3	4.52	185	
Efficacy	91lm/W	4	6.03	104	
TS992	Imax=442cd/klm	Imax	1669cd	5	7.54
					67

Driver	Colour	3000K	4000K
EL.	○	1T6861EL	1T6862EL
EL.	●	1T6863EL	1T6864EL
EL.	◐	1T6865EL	1T6866EL
DALI	○	1T6861DA	1T6862DA
DALI	●	1T6863DA	1T6864DA
DALI	◐	1T6865DA	1T6866DA

LED / 54W / UP-DOWN OPAL ± 6,7 IP20

		3000K	H(m)	D(m)	Emax(lx)
		Ra84		106°	
Fixture Power	60W	1	2.66	1161	
Source Flux	7830lm	2	5.33	290	
Fixture Flux	5318lm	3	7.99	129	
Efficacy	89lm/W	4	10.65	73	
TS994	Imax=148cd/klm	Imax	1161cd	5	13.32
					46

Driver	Colour	3000K	4000K
EL.	○	1T6897EL	1T6898EL
EL.	●	1T6899EL	1T6900EL
EL.	◐	1T6901EL	1T6902EL
DALI	○	1T6897DA	1T6898DA
DALI	●	1T6899DA	1T6900DA
DALI	◐	1T6901DA	1T6902DA

LED / 36W / UP-DOWN UGR ± 6,7 IP20

		3000K	H(m)	D(m)	Emax(lx)
		Ra84		74°	
Fixture Power	40W	1	1.51	1431	
Source Flux	5670lm	2	3.02	358	
Fixture Flux	3744lm	3	4.52	159	
Efficacy	94lm/W	4	6.03	89	
TS995	Imax=252cd/klm	Imax	1431cd	5	7.54
					57

Driver	Colour	3000K	4000K
EL.	○	1T6879EL	1T6880EL
EL.	●	1T6881EL	1T6882EL
EL.	◐	1T6883EL	1T6884EL
DALI	○	1T6879DA	1T6880DA
DALI	●	1T6881DA	1T6882DA
DALI	◐	1T6883DA	1T6884DA

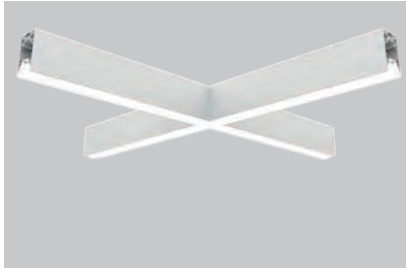

System Ceiling/ Suspension - continuous light module X connector

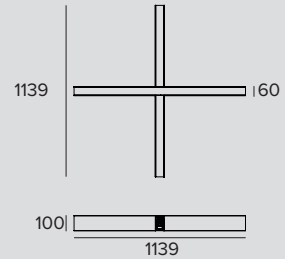

LED / 48W / DOWN OPAL



		3000K	H(m)	D(m)	E _{max} (lx)	
Ra84				106°		
Fixture Power	54W	1	2.66	1805		
Source Flux	6960lm	2	5.33	451		
Fixture Flux	4740lm	3	7.99	201		
Efficacy	88lm/W	4	10.65	113		
TS991	I _{max} =259cd/klm	I _{max}	1805cd	5	13.32	72

Driver	Colour	3000K	4000K
EL.	○	1T6000EL	1T6001EL
EL.	●	1T6004EL	1T6005EL
EL.	◐	1T6008EL	1T6009EL
DALI	○	1T6000DA	1T6001DA
DALI	●	1T6004DA	1T6005DA
DALI	◐	1T6008DA	1T6009DA

LED / 96W / DOWN OPAL



		3000K	H(m)	D(m)	E _{max} (lx)	
Ra84				106°		
Fixture Power	108W	1	2.66	3569		
Source Flux	13760lm	2	5.33	892		
Fixture Flux	9371lm	3	7.99	397		
Efficacy	87lm/W	4	10.65	223		
TS996	I _{max} =259cd/klm	I _{max}	3569cd	5	13.32	143

Driver	Colour	3000K	4000K
EL.	○	1T6002EL	1T6003EL
EL.	●	1T6006EL	1T6007EL
EL.	◐	1T6010EL	1T6011EL
DALI	○	1T6002DA	1T6003DA
DALI	●	1T6006DA	1T6007DA
DALI	◐	1T6010DA	1T6011DA

LED / 36W / DOWN UGR



		3000K	H(m)	D(m)	E _{max} (lx)	
Ra84				74°		
Fixture Power	40W	1	1.51	2225		
Source Flux	5040lm	2	3.02	556		
Fixture Flux	3263lm	3	4.52	247		
Efficacy	82lm/W	4	6.03	139		
TS992	I _{max} =442cd/klm	I _{max}	2225cd	5	7.54	89

Driver	Colour	3000K	4000K
EL.	○	1T6867EL	1T6868EL
EL.	●	1T6869EL	1T6870EL
EL.	◐	1T6871EL	1T6872EL
DALI	○	1T6867DA	1T6868DA
DALI	●	1T6869DA	1T6870DA
DALI	◐	1T6871DA	1T6872DA

LED / 72W / UP-DOWN OPAL



		3000K	H(m)	D(m)	E _{max} (lx)	
Ra84				106°		
Fixture Power	81W	1	2.66	1547		
Source Flux	10440lm	2	5.33	387		
Fixture Flux	7091lm	3	7.99	172		
Efficacy	88lm/W	4	10.65	97		
TS994	I _{max} =148cd/klm	I _{max}	1547cd	5	13.32	62

Driver	Colour	3000K	4000K
EL.	○	1T6903EL	1T6904EL
EL.	●	1T6905EL	1T6906EL
EL.	◐	1T6907EL	1T6908EL
DALI	○	1T6903DA	1T6904DA
DALI	●	1T6905DA	1T6906DA
DALI	◐	1T6907DA	1T6908DA

LED / 48W / UP-DOWN UGR



		3000K	H(m)	D(m)	E _{max} (lx)	
Ra84				74°		
Fixture Power	54W	1	1.51	1908		
Source Flux	7560lm	2	3.02	477		
Fixture Flux	4992lm	3	4.52	212		
Efficacy	92lm/W	4	6.03	119		
TS995	I _{max} =252cd/klm	I _{max}	1908cd	5	7.54	76

Driver	Colour	3000K	4000K
EL.	○	1T6885EL	1T6886EL
EL.	●	1T6887EL	1T6888EL
EL.	◐	1T6889EL	1T6890EL
DALI	○	1T6885DA	1T6886DA
DALI	●	1T6887DA	1T6888DA
DALI	◐	1T6889DA	1T6890DA

Note

Check mounting instructions to verify the quantity of DALI drivers installed.

Related codes

End Caps

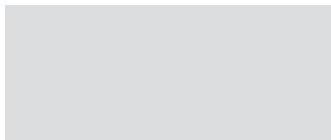

Colour	Code
○	1T5937
●	1T5938
●	1T5939

End caps for Ceiling Mounted, Suspension and Trimless versions.
2X

Mounting System

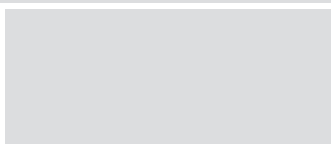
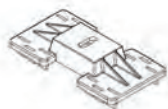

Colour	Code
○	1T5912
●	1T5913
●	1T5914

Ceiling installation: polycarbonate bracket.

To be ordered in the following quantities for every fixture length: 1 for 281mm version, 2 for the 562 / 1122 / 1135 / 1682 / 1695mm version, 3 for the 3364 / 3377mm version, 3 for the L/T version and 4 for the X version.

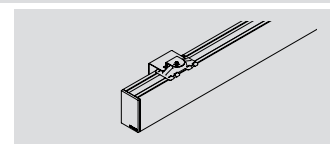
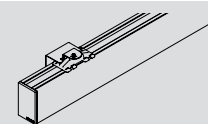

Colour	Code
○	1T6919
●	1T6920
●	1T6921

Wall installation: painted metal bracket.

To be ordered in the following quantities for every fixture length: 1 for the 281mm version, 2 for the 562 / 1122 / 1135 / 1682 / 1695mm version and 3 for the 3364 / 3377mm version.

Suspension

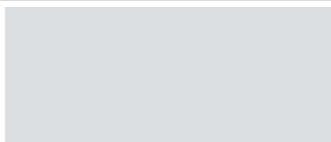

L	Colour	Code
2000	○	1T5899
2000	●	1T5900
2000	●	1T5901
4000	○	1T5902
4000	●	1T5903
4000	●	1T5904

Suspension cable.

To be ordered in the following quantities for every fixture length: 1 for 281mm version, 2 for the 562 / 1122 / 1135 / 1682 / 1695mm version, 3 for the 3364 / 3377mm version, 3 for the L/T version and 4 for the X version.

Suspension cable compatible with ceiling or wall installations, even inclined.

Power Supply Kit

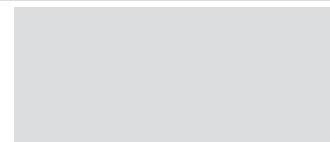
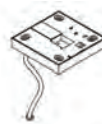

L	Driver	Colour	Code
4000	EL.	○	1T5905EL
4000	EL.	●	1T5906EL
4000	EL.	●	1T5907EL
4000	DALI	○	1T5905DA
4000	DALI	●	1T5906DA
4000	DALI	●	1T5907DA

Suspension installation kit: power cable complete with a painted polycarbonate rosette.

Max 0.6kW.

LOGICO

Accessories

Screen

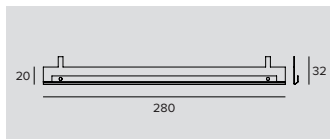

Code

1T6502

Accessory designed to improve the visual comfort of the Wall Washer version.
To be installed on a standard reflector.
Made of matte black painted aluminium.
280mm in length; to be ordered in the following quantities for every fixture length: 2 for the 562mm version, 4 for the 1122/1135/1146mm versions, 6 for the 1682/1695/1706mm versions and 12 for the 3364/3377/3386mm versions.

Electrical Connector



Code

1T5911

Linear electrical connector.

Control systems



Code

1T5349

Wireless control unit for DALI fixtures.
It generates a local DALI bus that can control individual fixtures.
The module can be connected to an existing DALI network.
The module is wireless controlled using a Casambi app for smartphones and tablets using Bluetooth 4.0 technology.
The devices create a wireless mesh network that can control up to 128 fixtures.
IP20.



Code

1T5352

IP20 Extender for wireless control of DALI fixtures.
It generates a local DALI bus with the capacity to drive up to 64 fixtures.
Can control DALI fixtures in indoor applications.
It is also equipped with a relay that can control non-dimmable fixtures up to a maximum of 6A.



System Trimless Recessed light module L. 562mm

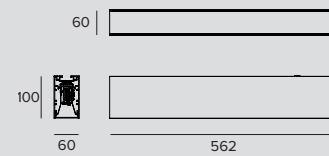

LED / 12W / DOWN OPAL



		3000K	H(m)	D(m)	E _{max} (lx)	
Ra84				106°		
Fixture Power	14W	1	2.66	451		
Source Flux	1740lm	2	5.33	113		
Fixture Flux	1185lm	3	7.99	50		
Efficacy	85lm/W	4	10.65	28		
TS991	I _{max} =259cd/klm	I _{max}	451cd	5	13.32	18

Driver	Colour	3000K	4000K
EL.	○	1T6019EL	1T6020EL
EL.	●	1T6023EL	1T6024EL
DALI	○	1T6019DA	1T6020DA
DALI	●	1T6023DA	1T6024DA

LED / 24W / DOWN OPAL



		3000K	H(m)	D(m)	E _{max} (lx)	
Ra84				106°		
Fixture Power	27W	1	2.66	892		
Source Flux	3440lm	2	5.33	223		
Fixture Flux	2343lm	3	7.99	99		
Efficacy	87lm/W	4	10.65	56		
TS996	I _{max} =259cd/klm	I _{max}	892cd	5	13.32	36

Driver	Colour	3000K	4000K
EL.	○	1T6021EL	1T6022EL
EL.	●	1T6025EL	1T6026EL
DALI	○	1T6021DA	1T6022DA
DALI	●	1T6025DA	1T6026DA

LED / 8W / DOWN UGR



		3000K	H(m)	D(m)	E _{max} (lx)	
Ra84				74°		
Fixture Power	9W	1	1.51	556		
Source Flux	1260lm	2	3.02	139		
Fixture Flux	816lm	3	4.52	62		
Efficacy	91lm/W	4	6.03	35		
TS992	I _{max} =442cd/klm	I _{max}	556cd	5	7.54	22

Driver	Colour	3000K	4000K
EL.	○	1T6813EL	1T6814EL
EL.	●	1T6815EL	1T6816EL
DALI	○	1T6813DA	1T6814DA
DALI	●	1T6815DA	1T6816DA

LED / 12W / DOWN WW



		3000K	H(m)	D1(m)	D2(m)	E _{max} (lx)	
Ra84				97°	101°		
Fixture Power	14W	1	2.28	2.55	1400		
Source Flux	1740lm	2	4.56	5.10	350		
Fixture Flux	1369lm	3	6.84	7.64	156		
Efficacy	98lm/W	4	9.12	10.19	88		
TS993	I _{max} =1001cd/klm	I _{max}	1743cd	5	11.40	12.74	56

Driver	Colour	3000K	4000K
EL.	○	1T6817EL	1T6818EL
EL.	●	1T6819EL	1T6820EL
DALI	○	1T6817DA	1T6818DA
DALI	●	1T6819DA	1T6820DA

LED / 24W / DOWN WW



		3000K	H(m)	D1(m)	D2(m)	E _{max} (lx)	
Ra84				97°	101°		
Fixture Power	27W	1	2.28	2.55	2768		
Source Flux	3440lm	2	4.56	5.10	692		
Fixture Flux	2707lm	3	6.84	7.64	308		
Efficacy	100lm/W	4	9.12	10.19	173		
TS997	I _{max} =1001cd/klm	I _{max}	3445cd	5	11.40	12.74	111

Driver	Colour	3000K	4000K
EL.	○	1T6821EL	1T6822EL
EL.	●	1T6823EL	1T6824EL
DALI	○	1T6821DA	1T6822DA
DALI	●	1T6823DA	1T6824DA



System Trimless Recessed light module L. 1122mm

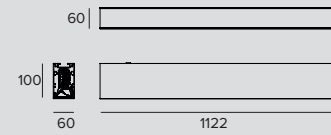

LED / 24W / DOWN OPAL



		3000K	H(m)	D(m)	Emax(lx)	
		Ra84		106°		
Fixture Power	27W	1	2.66	903		
Source Flux	3480lm	2	5.33	226		
Fixture Flux	2370lm	3	7.99	100		
Efficacy	88lm/W	4	10.65	56		
TS991	Imax=259cd/klm	Imax	903cd	5	13.32	36

Driver	Colour	3000K	4000K
EL.	○	1T5839EL	1T5840EL
EL.	●	1T5841EL	1T5842EL
DALI	○	1T5839DA	1T5840DA
DALI	●	1T5841DA	1T5842DA

LED / 48W / DOWN OPAL



		3000K	H(m)	D(m)	Emax(lx)	
		Ra84		106°		
Fixture Power	54W	1	2.66	1785		
Source Flux	6880lm	2	5.33	446		
Fixture Flux	4685lm	3	7.99	198		
Efficacy	87lm/W	4	10.65	112		
TS996	Imax=259cd/klm	Imax	1785cd	5	13.32	71

Driver	Colour	3000K	4000K
EL.	○	1T5843EL	1T5844EL
EL.	●	1T5845EL	1T5846EL
DALI	○	1T5843DA	1T5844DA
DALI	●	1T5845DA	1T5846DA

LED / 16W / DOWN UGR



		3000K	H(m)	D(m)	Emax(lx)	
		Ra84		74°		
Fixture Power	18W	1	1.51	1113		
Source Flux	2520lm	2	3.02	278		
Fixture Flux	1631lm	3	4.52	124		
Efficacy	91lm/W	4	6.03	70		
TS992	Imax=442cd/klm	Imax	1113cd	5	7.54	45

Driver	Colour	3000K	4000K
EL.	○	1T5847EL	1T5848EL
EL.	●	1T5849EL	1T5850EL
DALI	○	1T5847DA	1T5848DA
DALI	●	1T5849DA	1T5850DA

LED / 24W / DOWN WW



		3000K	H(m)	D1(m)	D2(m)	Emax(lx)	
		Ra84		97°	101°		
Fixture Power	27W	1	2.28	2.55	2801		
Source Flux	3480lm	2	4.56	5.10	700		
Fixture Flux	2739lm	3	6.84	7.64	311		
Efficacy	101lm/W	4	9.12	10.19	175		
TS993	Imax=1001cd/klm	Imax	3485cd	5	11.40	12.74	112

Driver	Colour	3000K	4000K
EL.	○	1T5851EL	1T5852EL
EL.	●	1T5853EL	1T5854EL
DALI	○	1T5851DA	1T5852DA
DALI	●	1T5853DA	1T5854DA

LED / 48W / DOWN WW



		3000K	H(m)	D1(m)	D2(m)	Emax(lx)	
		Ra84		97°	101°		
Fixture Power	54W	1	2.28	2.55	5537		
Source Flux	6880lm	2	4.56	5.10	1384		
Fixture Flux	5415lm	3	6.84	7.64	615		
Efficacy	100lm/W	4	9.12	10.19	346		
TS997	Imax=1001cd/klm	Imax	6890cd	5	11.40	12.74	221

Driver	Colour	3000K	4000K
EL.	○	1T5855EL	1T5856EL
EL.	●	1T5857EL	1T5858EL
DALI	○	1T5855DA	1T5856DA
DALI	●	1T5857DA	1T5858DA



System Trimless Recessed light module L. 1682mm

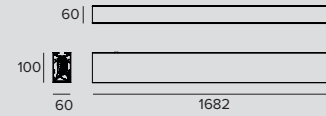

LED / 36W / DOWN OPAL									
	3000K	H(m)	D(m)	E _{max} (lx)	Driver	Colour	3000K	4000K	
	Ra84		106°		EL.	○	1T5859EL	1T5860EL	
	Fixture Power	40W	1	2.66	1354	EL.	●	1T5861EL	1T5862EL
	Source Flux	5220lm	2	5.33	338	DALI	○	1T5859DA	1T5860DA
	Fixture Flux	3555lm	3	7.99	150	DALI	●	1T5861DA	1T5862DA
	Efficacy	89lm/W	4	10.65	85				
TS991	I _{max} =259cd/klm	I _{max}	1354cd	5	13.32	54			

LED / 72W / DOWN OPAL									
	3000K	H(m)	D(m)	E _{max} (lx)	Driver	Colour	3000K	4000K	
	Ra84		106°		EL.	○	1T5863EL	1T5864EL	
	Fixture Power	81W	1	2.66	2677	EL.	●	1T5865EL	1T5866EL
	Source Flux	10320lm	2	5.33	669	DALI	○	1T5863DA	1T5864DA
	Fixture Flux	7028lm	3	7.99	297	DALI	●	1T5865DA	1T5866DA
	Efficacy	87lm/W	4	10.65	167				
TS996	I _{max} =259cd/klm	I _{max}	2677cd	5	13.32	107			

LED / 24W / DOWN UGR									
	3000K	H(m)	D(m)	E _{max} (lx)	Driver	Colour	3000K	4000K	
	Ra84		74°		EL.	○	1T5867EL	1T5868EL	
	Fixture Power	27W	1	1.51	1669	EL.	●	1T5869EL	1T5870EL
	Source Flux	3780lm	2	3.02	417	DALI	○	1T5867DA	1T5868DA
	Fixture Flux	2447lm	3	4.52	185	DALI	●	1T5869DA	1T5870DA
	Efficacy	91lm/W	4	6.03	104				
TS992	I _{max} =442cd/klm	I _{max}	1669cd	5	7.54	67			

LED / 36W / DOWN WW										
	3000K	H(m)	D1(m)	D2(m)	E _{max} (lx)	Driver	Colour	3000K	4000K	
	Ra84		97°	101°		EL.	○	1T5871EL	1T5872EL	
	Fixture Power	40W	1	2.28	2.55	4201	EL.	●	1T5873EL	1T5874EL
	Source Flux	5220lm	2	4.56	5.10	1050	DALI	○	1T5871DA	1T5872DA
	Fixture Flux	4108lm	3	6.84	7.64	467	DALI	●	1T5873DA	1T5874DA
	Efficacy	103lm/W	4	9.12	10.19	263				
TS993	I _{max} =1001cd/klm	I _{max}	5228cd	5	11.40	12.74	168			

LED / 72W / DOWN WW										
	3000K	H(m)	D1(m)	D2(m)	E _{max} (lx)	Driver	Colour	3000K	4000K	
	Ra84		97°	101°		EL.	○	1T5875EL	1T5876EL	
	Fixture Power	81W	1	2.28	2.55	8305	EL.	●	1T5877EL	1T5878EL
	Source Flux	10320lm	2	4.56	5.10	2076	DALI	○	1T5875DA	1T5876DA
	Fixture Flux	8122lm	3	6.84	7.64	923	DALI	●	1T5877DA	1T5878DA
	Efficacy	100lm/W	4	9.12	10.19	519				
TS997	I _{max} =1001cd/klm	I _{max}	10335cd	5	11.40	12.74	332			



System Trimless Recessed light module L. 3364mm

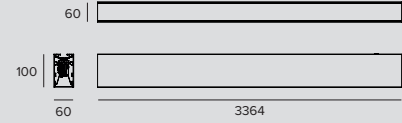

LED / 72W / DOWN OPAL						
		3000K	H(m)	D(m)	Emax(lx)	
		Ra84		106°		
Fixture Power	81W	1	2.66	2708		
Source Flux	10440lm	2	5.33	677		
Fixture Flux	7110lm	3	7.99	301		
Efficacy	88lm/W	4	10.65	169		
TS991	Imax=259cd/klm	Imax	2708cd	5	13.32	108

Driver	Colour	3000K	4000K
EL.	○	1T5879EL	1T5880EL
EL.	●	1T5881EL	1T5882EL
DALI	○	1T5879DA	1T5880DA
DALI	●	1T5881DA	1T5882DA

LED / 144W / DOWN OPAL						
		3000K	H(m)	D(m)	Emax(lx)	
		Ra84		106°		
Fixture Power	163W	1	2.66	5354		
Source Flux	20640lm	2	5.33	1338		
Fixture Flux	14056lm	3	7.99	595		
Efficacy	86lm/W	4	10.65	335		
TS996	Imax=259cd/klm	Imax	5354cd	5	13.32	214

Driver	Colour	3000K	4000K
EL.	○	1T5883EL	1T5884EL
EL.	●	1T5885EL	1T5886EL
DALI	○	1T5883DA	1T5884DA
DALI	●	1T5885DA	1T5886DA

LED / 48W / DOWN UGR						
		3000K	H(m)	D(m)	Emax(lx)	
		Ra84		74°		
Fixture Power	54W	1	1.51	3338		
Source Flux	7560lm	2	3.02	834		
Fixture Flux	4894lm	3	4.52	371		
Efficacy	91lm/W	4	6.03	209		
TS992	Imax=442cd/klm	Imax	3338cd	5	7.54	134

Driver	Colour	3000K	4000K
EL.	○	1T5887EL	1T5888EL
EL.	●	1T5889EL	1T5890EL
DALI	○	1T5887DA	1T5888DA
DALI	●	1T5889DA	1T5890DA

LED / 72W / DOWN WW							
		3000K	H(m)	D1(m)	D2(m)	Emax(lx)	
		Ra84		97°	101°		
Fixture Power	81W	1	2.28	2.55	8402		
Source Flux	10440lm	2	4.56	5.10	2101		
Fixture Flux	8216lm	3	6.84	7.64	934		
Efficacy	101lm/W	4	9.12	10.19	525		
TS993	Imax=1001cd/klm	Imax	10455cd	5	11.40	12.74	336

Driver	Colour	3000K	4000K
EL.	○	1T5891EL	1T5892EL
EL.	●	1T5893EL	1T5894EL
DALI	○	1T5891DA	1T5892DA
DALI	●	1T5893DA	1T5894DA

LED / 144W / DOWN WW							
		3000K	H(m)	D1(m)	D2(m)	Emax(lx)	
		Ra84		97°	101°		
Fixture Power	163W	1	2.28	2.55	16611		
Source Flux	20640lm	2	4.56	5.10	4153		
Fixture Flux	16244lm	3	6.84	7.64	1846		
Efficacy	100lm/W	4	9.12	10.19	1038		
TS997	Imax=1001cd/klm	Imax	20670cd	5	11.40	12.74	664

Driver	Colour	3000K	4000K
EL.	○	1T5895EL	1T5896EL
EL.	●	1T5897EL	1T5898EL
DALI	○	1T5895DA	1T5896DA
DALI	●	1T5897DA	1T5898DA

Note

Check mounting instructions to verify the quantity of DALI drivers installed.

Related codes

Insertion Box

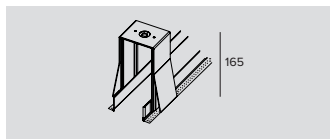

Kg	Cutout hole	L	Code
1.25	80x281	281	1T7369
1.8	80x562	562	1T6051
3.2	80x1122	1122	1T5915
3.8	80x1682	1682	1T5916

Outer casing for trimless installation.

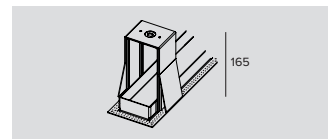

Kg	Cutout hole	L	Code
1.3	80x291	306	1T7370
1.9	80x572	587	1T6052
3.2	80x1132	1147	1T5917
3.8	80x1692	1707	1T5921

Terminal outer casing for trimless installation.

End Caps

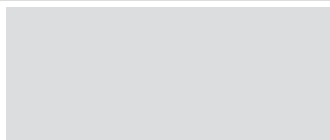

Colour	Code
○	1T5937
●	1T5938

End caps for Ceiling Mounted, Suspension and Trimless versions.
2X

Accessories

Screen

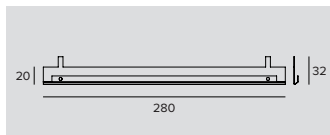

Code
1T6502

Accessory designed to improve the visual comfort of the Wall Washer version.
To be installed on a standard reflector.
Made of matte black painted aluminium.
280mm in length; to be ordered in the following quantities for every fixture length: 2 for the 562mm version, 4 for the 1122/1135/1146mm versions, 6 for the 1682/1695/1706mm versions and 12 for the 3364/3377/3386mm versions.

Electrical Connector

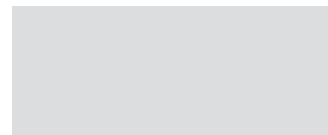

Code
1T5911

Linear electrical connector.

Control systems

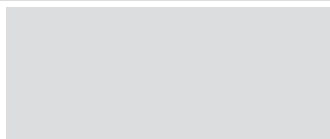

Code
1T5349

Wireless control unit for DALI fixtures.
It generates a local DALI bus that can control individual fixtures.
The module can be connected to an existing DALI network.
The module is wireless controlled using a Casambi app for smartphones and tablets using Bluetooth 4.0 technology.
The devices create a wireless mesh network that can control up to 128 fixtures.
IP20.

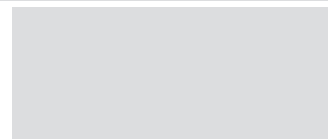

Code
1T5352

IP20 Extender for wireless control of DALI fixtures.
It generates a local DALI bus with the capacity to drive up to 64 fixtures.
Can control DALI fixtures in indoor applications.
It is also equipped with a relay that can control non-dimmable fixtures up to a maximum of 6A.

LOGICO





System Recessed with flange - continuous light module L. 562mm

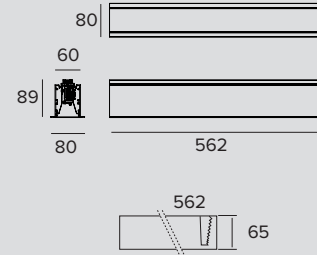

LED / 12W / DOWN OPAL									
	3000K	H(m)	D(m)	E _{max} (lx)	Driver	Colour	3000K	4000K	
	Ra84			106°	EL.	○	1T6015EL	1T6016EL	
	Fixture Power	14W	1	2.66	451	DALI	○	1T6015DA	1T6016DA
	Source Flux	1740lm	2	5.33	113				
	Fixture Flux	1185lm	3	7.99	50				
	Efficacy	85lm/W	4	10.65	28				
TS991	I _{max} =259cd/klm	I _{max}	451cd	5	13.32	18			

LED / 24W / DOWN OPAL									
	3000K	H(m)	D(m)	E _{max} (lx)	Driver	Colour	3000K	4000K	
	Ra84			106°	EL.	○	1T6017EL	1T6018EL	
	Fixture Power	27W	1	2.66	892	DALI	○	1T6017DA	1T6018DA
	Source Flux	3440lm	2	5.33	223				
	Fixture Flux	2343lm	3	7.99	99				
	Efficacy	87lm/W	4	10.65	56				
TS996	I _{max} =259cd/klm	I _{max}	892cd	5	13.32	36			

LED / 8W / DOWN UGR									
	3000K	H(m)	D(m)	E _{max} (lx)	Driver	Colour	3000K	4000K	
	Ra84			74°	EL.	○	1T6807EL	1T6808EL	
	Fixture Power	9W	1	1.51	556	DALI	○	1T6807DA	1T6808DA
	Source Flux	1260lm	2	3.02	139				
	Fixture Flux	816lm	3	4.52	62				
	Efficacy	91lm/W	4	6.03	35				
TS992	I _{max} =442cd/klm	I _{max}	556cd	5	7.54	22			

LED / 12W / DOWN WW										
	3000K	H(m)	D1(m)	D2(m)	E _{max} (lx)	Driver	Colour	3000K	4000K	
	Ra84				97° 101°	EL.	○	1T6809EL	1T6810EL	
	Fixture Power	14W	1	2.28	2.55	1400	DALI	○	1T6809DA	1T6810DA
	Source Flux	1740lm	2	4.56	5.10	350				
	Fixture Flux	1369lm	3	6.84	7.64	156				
	Efficacy	98lm/W	4	9.12	10.19	88				
TS993	I _{max} =1001cd/klm	I _{max}	1743cd	5	11.40	12.74	56			

LED / 24W / DOWN WW										
	3000K	H(m)	D1(m)	D2(m)	E _{max} (lx)	Driver	Colour	3000K	4000K	
	Ra84				97° 101°	EL.	○	1T6811EL	1T6812EL	
	Fixture Power	27W	1	2.28	2.55	2768	DALI	○	1T6811DA	1T6812DA
	Source Flux	3440lm	2	4.56	5.10	692				
	Fixture Flux	2707lm	3	6.84	7.64	308				
	Efficacy	100lm/W	4	9.12	10.19	173				
TS997	I _{max} =1001cd/klm	I _{max}	3445cd	5	11.40	12.74	111			



System Recessed with flange - continuous light module L. 1122mm

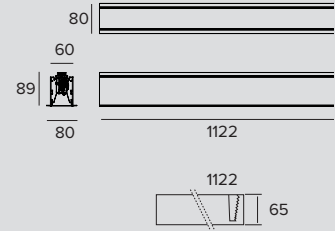

LED / 24W / DOWN OPAL



		3000K	H(m)	D(m)	Emax(lx)	
		Ra84		106°		
Fixture Power	27W	1	2.66	903		
Source Flux	3480lm	2	5.33	226		
Fixture Flux	2370lm	3	7.99	100		
Efficacy	88lm/W	4	10.65	56		
TS991	Imax=259cd/klm	Imax	903cd	5	13.32	36

Driver	Colour	3000K	4000K
EL.	○	1T5461EL	1T5462EL
DALI	○	1T5461DA	1T5462DA

LED / 48W / DOWN OPAL



		3000K	H(m)	D(m)	Emax(lx)	
		Ra84		106°		
Fixture Power	54W	1	2.66	1785		
Source Flux	6880lm	2	5.33	446		
Fixture Flux	4685lm	3	7.99	198		
Efficacy	87lm/W	4	10.65	112		
TS996	Imax=259cd/klm	Imax	1785cd	5	13.32	71

Driver	Colour	3000K	4000K
EL.	○	1T5463EL	1T5464EL
DALI	○	1T5463DA	1T5464DA

LED / 16W / DOWN UGR



		3000K	H(m)	D(m)	Emax(lx)	
		Ra84		74°		
Fixture Power	18W	1	1.51	1113		
Source Flux	2520lm	2	3.02	278		
Fixture Flux	1631lm	3	4.52	124		
Efficacy	91lm/W	4	6.03	70		
TS992	Imax=442cd/klm	Imax	1113cd	5	7.54	45

Driver	Colour	3000K	4000K
EL.	○	1T5465EL	1T5466EL
DALI	○	1T5465DA	1T5466DA

LED / 24W / DOWN WW



		3000K	H(m)	D1(m)	D2(m)	Emax(lx)	
		Ra84		97°	101°		
Fixture Power	27W	1	2.28	2.55	2801		
Source Flux	3480lm	2	4.56	5.10	700		
Fixture Flux	2739lm	3	6.84	7.64	311		
Efficacy	101lm/W	4	9.12	10.19	175		
TS993	Imax=1001cd/klm	Imax	3485cd	5	11.40	12.74	112

Driver	Colour	3000K	4000K
EL.	○	1T5467EL	1T5468EL
DALI	○	1T5467DA	1T5468DA

LED / 48W / DOWN WW



		3000K	H(m)	D1(m)	D2(m)	Emax(lx)	
		Ra84		97°	101°		
Fixture Power	54W	1	2.28	2.55	5537		
Source Flux	6880lm	2	4.56	5.10	1384		
Fixture Flux	5415lm	3	6.84	7.64	615		
Efficacy	100lm/W	4	9.12	10.19	346		
TS997	Imax=1001cd/klm	Imax	6890cd	5	11.40	12.74	221

Driver	Colour	3000K	4000K
EL.	○	1T5469EL	1T5470EL
DALI	○	1T5469DA	1T5470DA



System Recessed with flange - continuous light module L. 1682mm

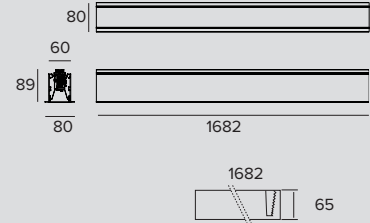

LED / 36W / DOWN OPAL						
	3000K	H(m)	D(m)	Emax(lx)		
	Ra84			106°		
	Fixture Power	40W	1	2.66	1354	
	Source Flux	5220lm	2	5.33	338	
	Fixture Flux	3555lm	3	7.99	150	
	Efficacy	89lm/W	4	10.65	85	
TS991	Imax=259cd/klm	Imax	1354cd	5	13.32	54
Driver		Colour		3000K	4000K	
EL.		○		1T5471EL	1T5472EL	
DALI		○		1T5471DA	1T5472DA	

LED / 72W / DOWN OPAL						
	3000K	H(m)	D(m)	Emax(lx)		
	Ra84			106°		
	Fixture Power	81W	1	2.66	2677	
	Source Flux	10320lm	2	5.33	669	
	Fixture Flux	7028lm	3	7.99	297	
	Efficacy	87lm/W	4	10.65	167	
TS996	Imax=259cd/klm	Imax	2677cd	5	13.32	107
Driver		Colour		3000K	4000K	
EL.		○		1T5473EL	1T5474EL	
DALI		○		1T5473DA	1T5474DA	

LED / 24W / DOWN UGR						
	3000K	H(m)	D(m)	Emax(lx)		
	Ra84			74°		
	Fixture Power	27W	1	1.51	1669	
	Source Flux	3780lm	2	3.02	417	
	Fixture Flux	2447lm	3	4.52	185	
	Efficacy	91lm/W	4	6.03	104	
TS992	Imax=442cd/klm	Imax	1669cd	5	7.54	67
Driver		Colour		3000K	4000K	
EL.		○		1T5475EL	1T5476EL	
DALI		○		1T5475DA	1T5476DA	

LED / 36W / DOWN WW							
	3000K	H(m)	D1(m)	D2(m)	Emax(lx)		
	Ra84		97°	101°			
	Fixture Power	40W	1	2.28	2.55	4201	
	Source Flux	5220lm	2	4.56	5.10	1050	
	Fixture Flux	4108lm	3	6.84	7.64	467	
	Efficacy	103lm/W	4	9.12	10.19	263	
TS993	Imax=1001cd/klm	Imax	5228cd	5	11.40	12.74	168
Driver		Colour		3000K	4000K		
EL.		○		1T5477EL	1T5478EL		
DALI		○		1T5477DA	1T5478DA		

LED / 72W / DOWN WW							
	3000K	H(m)	D1(m)	D2(m)	Emax(lx)		
	Ra84		97°	101°			
	Fixture Power	81W	1	2.28	2.55	8305	
	Source Flux	10320lm	2	4.56	5.10	2076	
	Fixture Flux	8122lm	3	6.84	7.64	923	
	Efficacy	100lm/W	4	9.12	10.19	519	
TS997	Imax=1001cd/klm	Imax	10335cd	5	11.40	12.74	332
Driver		Colour		3000K	4000K		
EL.		○		1T5479EL	1T5480EL		
DALI		○		1T5479DA	1T5480DA		



System Recessed with flange - continuous light module L. 3364mm

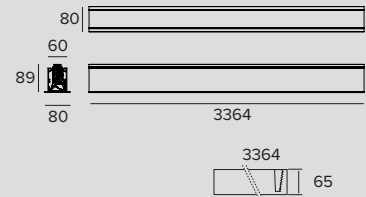

LED / 72W / DOWN OPAL



		3000K	H(m)	D(m)	Emax(lx)
		Ra84		106°	
Fixture Power	81W	1	2.66	2708	
Source Flux	10440lm	2	5.33	677	
Fixture Flux	7110lm	3	7.99	301	
Efficacy	88lm/W	4	10.65	169	
TS991	Imax=259cd/klm	Imax	2708cd	5	13.32

Driver	Colour	3000K	4000K
EL.	○	1T5481EL	1T5482EL
DALI	○	1T5481DA	1T5482DA

LED / 144W / DOWN OPAL



		3000K	H(m)	D(m)	Emax(lx)
		Ra84		106°	
Fixture Power	163W	1	2.66	5354	
Source Flux	20640lm	2	5.33	1338	
Fixture Flux	14056lm	3	7.99	595	
Efficacy	86lm/W	4	10.65	335	
TS996	Imax=259cd/klm	Imax	5354cd	5	13.32

Driver	Colour	3000K	4000K
EL.	○	1T5483EL	1T5484EL
DALI	○	1T5483DA	1T5484DA

LED / 48W / DOWN UGR



		3000K	H(m)	D(m)	Emax(lx)
		Ra84		74°	
Fixture Power	54W	1	1.51	3338	
Source Flux	7560lm	2	3.02	834	
Fixture Flux	4894lm	3	4.52	371	
Efficacy	91lm/W	4	6.03	209	
TS992	Imax=442cd/klm	Imax	3338cd	5	7.54

Driver	Colour	3000K	4000K
EL.	○	1T5485EL	1T5486EL
DALI	○	1T5485DA	1T5486DA

LED / 72W / DOWN WW



		3000K	H(m)	D1(m)	D2(m)	Emax(lx)
		Ra84		97°	101°	
Fixture Power	81W	1	2.28	2.55	8402	
Source Flux	10440lm	2	4.56	5.10	2101	
Fixture Flux	8216lm	3	6.84	7.64	934	
Efficacy	101lm/W	4	9.12	10.19	525	
TS993	Imax=1001cd/klm	Imax	10455cd	5	11.40	

Driver	Colour	3000K	4000K
EL.	○	1T5487EL	1T5488EL
DALI	○	1T5487DA	1T5488DA

LED / 144W / DOWN WW



		3000K	H(m)	D1(m)	D2(m)	Emax(lx)
		Ra84		97°	101°	
Fixture Power	163W	1	2.28	2.55	16611	
Source Flux	20640lm	2	4.56	5.10	4153	
Fixture Flux	16244lm	3	6.84	7.64	1846	
Efficacy	100lm/W	4	9.12	10.19	1038	
TS997	Imax=1001cd/klm	Imax	20670cd	5	11.40	

Driver	Colour	3000K	4000K
EL.	○	1T5489EL	1T5490EL
DALI	○	1T5489DA	1T5490DA



System Recessed with flange - continuous light module L connector

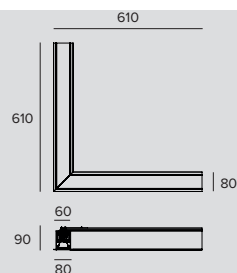

LED / 24W / DOWN OPAL

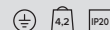

		3000K	H(m)	D(m)	E _{max} (lx)	
Ra84				106°		
Fixture Power	27W	1	2.66	903		
Source Flux	3480lm	2	5.33	226		
Fixture Flux	2370lm	3	7.99	100		
Efficacy	88lm/W	4	10.65	56		
TS991	Imax=259cd/klm	Imax	903cd	5	13.32	36

Driver	Colour	3000K	4000K
EL.	○	1T5940EL	1T5941EL
DALI	○	1T5940DA	1T5941DA

LED / 48W / DOWN OPAL



		3000K	H(m)	D(m)	E _{max} (lx)	
Ra84				106°		
Fixture Power	54W	1	2.66	1785		
Source Flux	6880lm	2	5.33	446		
Fixture Flux	4685lm	3	7.99	198		
Efficacy	87lm/W	4	10.65	112		
TS996	Imax=259cd/klm	Imax	1785cd	5	13.32	71

Driver	Colour	3000K	4000K
EL.	○	1T5942EL	1T5943EL
DALI	○	1T5942DA	1T5943DA

LED / 16W / DOWN UGR



		3000K	H(m)	D(m)	E _{max} (lx)	
Ra84				74°		
Fixture Power	18W	1	1.51	1113		
Source Flux	2520lm	2	3.02	278		
Fixture Flux	1631lm	3	4.52	124		
Efficacy	91lm/W	4	6.03	70		
TS992	Imax=442cd/klm	Imax	1113cd	5	7.54	45

Driver	Colour	3000K	4000K
EL.	○	1T6849EL	1T6850EL
DALI	○	1T6849DA	1T6850DA

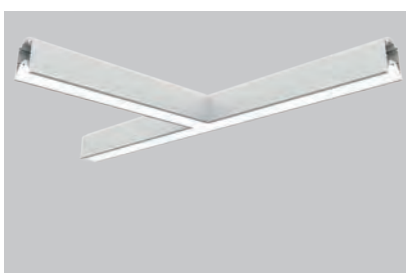

System Recessed with flange - continuous light module T connector

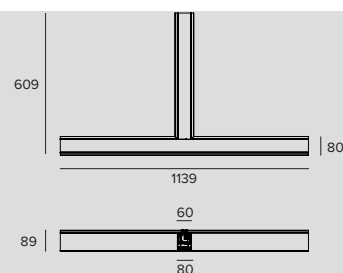

LED / 36W / DOWN OPAL

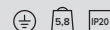

		3000K	H(m)	D(m)	E _{max} (lx)	
Ra84				106°		
Fixture Power	40W	1	2.66	1354		
Source Flux	5220lm	2	5.33	338		
Fixture Flux	3555lm	3	7.99	150		
Efficacy	89lm/W	4	10.65	85		
TS991	Imax=259cd/klm	Imax	1354cd	5	13.32	54

Driver	Colour	3000K	4000K
EL.	○	1T5944EL	1T5945EL
DALI	○	1T5944DA	1T5945DA

LOGICO

LED / 72W / DOWN OPAL



		3000K	H(m)	D(m)	E _{max} (lx)
Ra84				106°	
Fixture Power	81W	1	2.66	2677	
Source Flux	10320lm	2	5.33	669	
Fixture Flux	7028lm	3	7.99	297	
Efficacy	87lm/W	4	10.65	167	
TS996	Imax=259cd/klm	Imax	2677cd	5	13.32

Driver	Colour	3000K	4000K
EL.	○	1T5946EL	1T5947EL
DALI	○	1T5946DA	1T5947DA

LED / 24W / DOWN UGR



		3000K	H(m)	D(m)	E _{max} (lx)
Ra84				74°	
Fixture Power	27W	1	1.51	1669	
Source Flux	3780lm	2	3.02	417	
Fixture Flux	2447lm	3	4.52	185	
Efficacy	91lm/W	4	6.03	104	
TS992	Imax=442cd/klm	Imax	1669cd	5	7.54

Driver	Colour	3000K	4000K
EL.	○	1T6851EL	1T6852EL
DALI	○	1T6851DA	1T6852DA

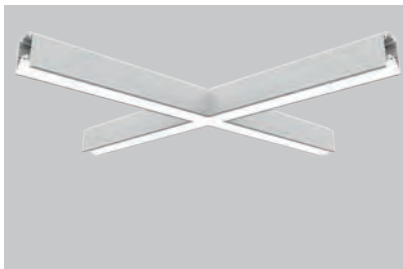

System Recessed with flange - continuous light module X connector

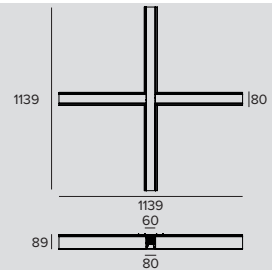

LED / 48W / DOWN OPAL



		3000K	H(m)	D(m)	E _{max} (lx)
Ra84				106°	
Fixture Power	54W	1	2.66	1805	
Source Flux	6960lm	2	5.33	451	
Fixture Flux	4740lm	3	7.99	201	
Efficacy	88lm/W	4	10.65	113	
TS991	Imax=259cd/klm	Imax	1805cd	5	13.32

Driver	Colour	3000K	4000K
EL.	○	1T5948EL	1T5949EL
DALI	○	1T5948DA	1T5949DA

LED / 96W / DOWN OPAL



		3000K	H(m)	D(m)	E _{max} (lx)
Ra84				106°	
Fixture Power	108W	1	2.66	3569	
Source Flux	13760lm	2	5.33	892	
Fixture Flux	9371lm	3	7.99	397	
Efficacy	87lm/W	4	10.65	223	
TS996	Imax=259cd/klm	Imax	3569cd	5	13.32

Driver	Colour	3000K	4000K
EL.	○	1T5950EL	1T5951EL
DALI	○	1T5950DA	1T5951DA

LED / 36W / DOWN UGR



		3000K	H(m)	D(m)	E _{max} (lx)
Ra84				74°	
Fixture Power	40W	1	1.51	2225	
Source Flux	5040lm	2	3.02	556	
Fixture Flux	3263lm	3	4.52	247	
Efficacy	82lm/W	4	6.03	139	
TS992	Imax=442cd/klm	Imax	2225cd	5	7.54

Driver	Colour	3000K	4000K
EL.	○	1T6853EL	1T6854EL
DALI	○	1T6853DA	1T6854DA

Note

Check mounting instructions to verify the quantity of DALI drivers installed.

Related codes

End Caps



Code

1T5908

End caps for the recessed version with a flange.
White.
2X

Accessories

Screen

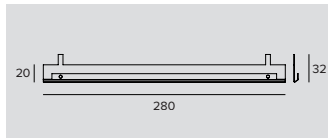

Code

1T6502

Accessory designed to improve the visual comfort of the Wall Washer version.
To be installed on a standard reflector.
Made of matte black painted aluminium.
280mm in length; to be ordered in the following quantities for every fixture length: 2 for the 562mm version, 4 for the 1122/1135/1146mm versions, 6 for the 1682/1695/1706mm versions and 12 for the 3364/3377/3386mm versions.

Electrical Connector



Code

1T5911

Linear electrical connector.

Control systems



Code

1T5349

Wireless control unit for DALI fixtures.
It generates a local DALI bus that can control individual fixtures.
The module can be connected to an existing DALI network.
The module is wireless controlled using a Casambi app for smartphones and tablets using Bluetooth 4.0 technology.
The devices create a wireless mesh network that can control up to 128 fixtures.
IP20.



Code

1T5352

IP20 Extender for wireless control of DALI fixtures.
It generates a local DALI bus with the capacity to drive up to 64 fixtures.
Can control DALI fixtures in indoor applications.
It is also equipped with a relay that can control non-dimmable fixtures up to a maximum of 6A.

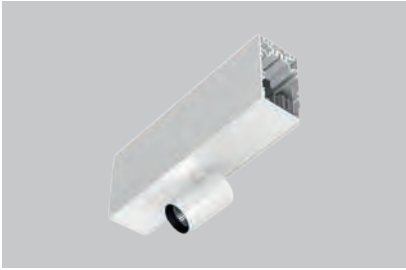

System Ceiling/ Suspension - projector module Label 4

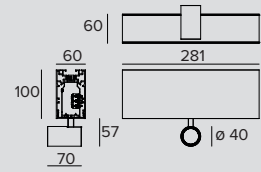

LED / 1x8W / SP										
	3000K	H(m)	D(m)	Emax(lx)	Driver	Colour	3000K	4000K		
	Ra90		18°		EL.	○	1T7221EL	1T7224EL		
	Fixture Power	9W	1	0.31	4214	EL.	●	1T7227EL	1T7230EL	
	Source Flux	982lm	2	0.62	1053	EL.	●	1T7233EL	1T7236EL	
	Fixture Flux	622lm	3	0.93	468	DALI	○	1T7221DA	1T7224DA	
	Efficacy	71lm/W	4	1.24	263	DALI	●	1T7227DA	1T7230DA	
TS1165	Imax=4291cd/klm	Imax	4214cd	5	1.55	169	DALI	●	1T7233DA	1T7236DA

LED / 1x8W / FL										
	3000K	H(m)	D(m)	Emax(lx)	Driver	Colour	3000K	4000K		
	Ra90		27°		EL.	○	1T7222EL	1T7225EL		
	Fixture Power	9W	1	0.48	3199	EL.	●	1T7228EL	1T7231EL	
	Source Flux	1129lm	2	0.95	800	EL.	●	1T7234EL	1T7237EL	
	Fixture Flux	806lm	3	1.43	355	DALI	○	1T7222DA	1T7225DA	
	Efficacy	92lm/W	4	1.91	200	DALI	●	1T7228DA	1T7231DA	
TS1166	Imax=2834cd/klm	Imax	3199cd	5	2.38	128	DALI	●	1T7234DA	1T7237DA

LED / 1x8W / MWFL										
	3000K	H(m)	D(m)	Emax(lx)	Driver	Colour	3000K	4000K		
	Ra90		42°		EL.	○	1T7223EL	1T7226EL		
	Fixture Power	9W	1	0.76	1831	EL.	●	1T7229EL	1T7232EL	
	Source Flux	1129lm	2	1.52	458	EL.	●	1T7235EL	1T7238EL	
	Fixture Flux	835lm	3	2.28	203	DALI	○	1T7223DA	1T7226DA	
	Efficacy	95lm/W	4	3.04	114	DALI	●	1T7229DA	1T7232DA	
TS1167	Imax=1622cd/klm	Imax	1831cd	5	3.80	73	DALI	●	1T7235DA	1T7238DA



System Ceiling/ Suspension - projector module Label 4

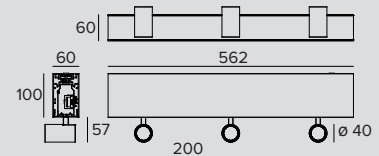

LED / 3x8W / SP										
	3000K	H(m)	D(m)	Emax(lx)	Driver	Colour	3000K	4000K		
	Ra90		18°		EL.	○	1T7239EL	1T7242EL		
	Fixture Power	9W	1	0.31	4214	EL.	●	1T7245EL	1T7248EL	
	Source Flux	982lm	2	0.62	1053	EL.	●	1T7251EL	1T7254EL	
	Fixture Flux	622lm	3	0.93	468	DALI	○	1T7239DA	1T7242DA	
	Efficacy	71lm/W	4	1.24	263	DALI	●	1T7245DA	1T7248DA	
TS1165	Imax=4291cd/klm	Imax	4214cd	5	1.55	169	DALI	●	1T7251DA	1T7254DA

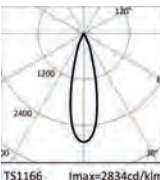
LED / 3x8W / FL										
	3000K	H(m)	D(m)	Emax(lx)	Driver	Colour	3000K	4000K		
	Ra90		27°		EL.	○	1T7240EL	1T7243EL		
	Fixture Power	9W	1	0.48	3199	EL.	●	1T7246EL	1T7249EL	
	Source Flux	1129lm	2	0.95	800	EL.	●	1T7252EL	1T7255EL	
	Fixture Flux	806lm	3	1.43	355	DALI	○	1T7240DA	1T7243DA	
	Efficacy	92lm/W	4	1.91	200	DALI	●	1T7246DA	1T7249DA	
TS1166	Imax=2834cd/klm	Imax	3199cd	5	2.38	128	DALI	●	1T7252DA	1T7255DA

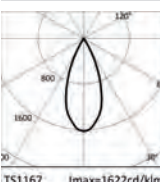
LED / 3x8W / MWFL										
	3000K	H(m)	D(m)	Emax(lx)	Driver	Colour	3000K	4000K		
	Ra90		42°		EL.	○	1T7241EL	1T7244EL		
	Fixture Power	9W	1	0.76	1831	EL.	●	1T7247EL	1T7250EL	
	Source Flux	1129lm	2	1.52	458	EL.	●	1T7253EL	1T7256EL	
	Fixture Flux	835lm	3	2.28	203	DALI	○	1T7241DA	1T7244DA	
	Efficacy	95lm/W	4	3.04	114	DALI	●	1T7247DA	1T7250DA	
TS1167	Imax=1622cd/klm	Imax	1831cd	5	3.80	73	DALI	●	1T7253DA	1T7256DA

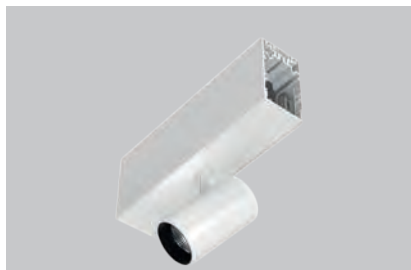

System Ceiling/ Suspension - projector module Label 6

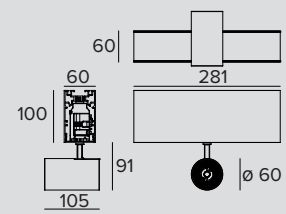

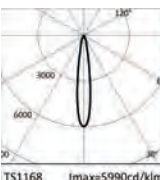
LED / 1x14W / SP										
	3000K	H(m)	D(m)	Emax(lx)	Driver	Colour	3000K	4000K		
	Ra90		16°		EL.	○	1T7305EL	1T7308EL		
	Fixture Power	15W	1	0.28	10741	EL.	●	1T7311EL	1T7314EL	
	Source Flux	1793lm	2	0.55	2685	EL.	●	1T7317EL	1T7320EL	
	Fixture Flux	1316lm	3	0.83	1193	DALI	○	1T7305DA	1T7308DA	
	Efficacy	91lm/W	4	1.11	671	DALI	●	1T7311DA	1T7314DA	
TS1168	Imax=5990cd/klm	Imax	10741cd	5	1.39	430	DALI	●	1T7317DA	1T7320DA

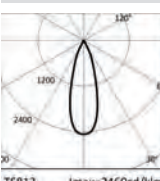
LED / 1x14W / FL										
	3000K	H(m)	D(m)	Emax(lx)	Driver	Colour	3000K	4000K		
	Ra90		31°		EL.	○	1T7306EL	1T7309EL		
	Fixture Power	15W	1	0.56	4410	EL.	●	1T7312EL	1T7315EL	
	Source Flux	1793lm	2	1.12	1102	EL.	●	1T7318EL	1T7321EL	
	Fixture Flux	1386lm	3	1.67	490	DALI	○	1T7306DA	1T7309DA	
	Efficacy	96lm/W	4	2.23	276	DALI	●	1T7312DA	1T7315DA	
TS1169	Imax=2460cd/klm	Imax	4410cd	5	2.79	176	DALI	●	1T7318DA	1T7321DA

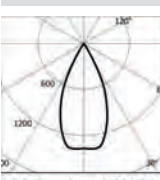
LED / 1x14W / MWFL										
	3000K	H(m)	D(m)	Emax(lx)	Driver	Colour	3000K	4000K		
	Ra90		48°		EL.	○	1T7307EL	1T7310EL		
	Fixture Power	15W	1	0.88	2457	EL.	●	1T7313EL	1T7316EL	
	Source Flux	1793lm	2	1.77	614	EL.	●	1T7319EL	1T7322EL	
	Fixture Flux	1373lm	3	2.65	273	DALI	○	1T7307DA	1T7310DA	
	Efficacy	95lm/W	4	3.53	154	DALI	●	1T7313DA	1T7316DA	
TS1170	Imax=1378cd/klm	Imax	2471cd	5	4.41	98	DALI	●	1T7319DA	1T7322DA



System Ceiling/ Suspension - projector module Label 6

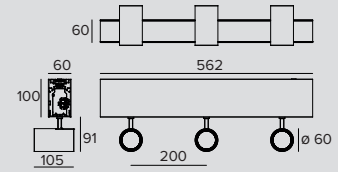

LED / 3x14W / SP									
					3000K	H(m)	D(m)	Emax(lx)	
					Ra90		16°		
Fixture Power	15W	1	0.28	10741	Driver	Colour	3000K	4000K	
Source Flux	1793lm	2	0.55	2685	EL.	○	1T7323EL	1T7326EL	
Fixture Flux	1316lm	3	0.83	1193	EL.	●	1T7329EL	1T7332EL	
Efficacy	91lm/W	4	1.11	671	EL.	●	1T7335EL	1T7338EL	
TS1168	Imax=5990cd/klm	Imax	10741cd	430	DALI	○	1T7323DA	1T7326DA	
					DALI	●	1T7329DA	1T7332DA	
					DALI	●	1T7335DA	1T7338DA	

LED / 3x14W / FL									
					3000K	H(m)	D(m)	Emax(lx)	
					Ra90		31°		
Fixture Power	15W	1	0.56	4410	Driver	Colour	3000K	4000K	
Source Flux	1793lm	2	1.12	1102	EL.	○	1T7324EL	1T7327EL	
Fixture Flux	1386lm	3	1.67	490	EL.	●	1T7330EL	1T7333EL	
Efficacy	96lm/W	4	2.23	276	EL.	●	1T7336EL	1T7339EL	
TS813	Imax=2460cd/klm	Imax	4410cd	176	DALI	○	1T7324DA	1T7327DA	
					DALI	●	1T7330DA	1T7333DA	
					DALI	●	1T7336DA	1T7339DA	

LED / 3x14W / MWFL									
					3000K	H(m)	D(m)	Emax(lx)	
					Ra90		48°		
Fixture Power	15W	1	0.88	2457	Driver	Colour	3000K	4000K	
Source Flux	1793lm	2	1.77	614	EL.	○	1T7325EL	1T7328EL	
Fixture Flux	1373lm	3	2.65	273	EL.	●	1T7331EL	1T7334EL	
Efficacy	95lm/W	4	3.53	154	EL.	●	1T7337EL	1T7340EL	
TS1170	Imax=1378cd/klm	Imax	2471cd	98	DALI	○	1T7325DA	1T7328DA	
					DALI	●	1T7331DA	1T7334DA	
					DALI	●	1T7337DA	1T7340DA	

Related codes

End Caps

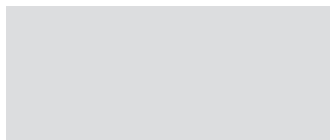

Colour	Code
○	1T5937
●	1T5938
●	1T5939

End caps for Ceiling Mounted, Suspension and Trimless versions.
2X

Mounting System

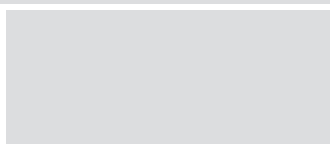

Colour	Code
○	1T5912
●	1T5913
●	1T5914

Ceiling installation: polycarbonate bracket.

To be ordered in the following quantities for every fixture length: 1 for 281mm version, 2 for the 562 / 1122 / 1135 / 1682 / 1695mm version, 3 for the 3364 / 3377mm version, 3 for the L/T version and 4 for the X version.

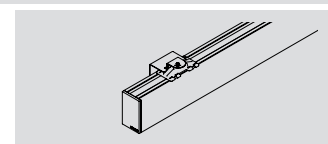
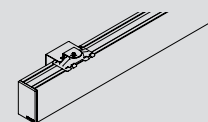

Colour	Code
○	1T6919
●	1T6920
●	1T6921

Wall installation: painted metal bracket.

To be ordered in the following quantities for every fixture length: 1 for the 281mm version, 2 for the 562 / 1122 / 1135 / 1682 / 1695mm version and 3 for the 3364 / 3377mm version.

Suspension

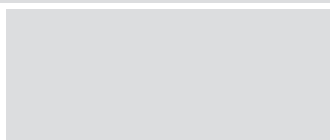

L	Colour	Code
2000	○	1T5899
2000	●	1T5900
2000	●	1T5901
4000	○	1T5902
4000	●	1T5903
4000	●	1T5904

Suspension cable.

To be ordered in the following quantities for every fixture length: 1 for 281mm version, 2 for the 562 / 1122 / 1135 / 1682 / 1695mm version, 3 for the 3364 / 3377mm version, 3 for the L/T version and 4 for the X version.

Suspension cable compatible with ceiling or wall installations, even inclined.

Power Supply Kit

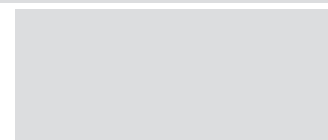

L	Driver	Colour	Code
4000	EL.	○	1T5905EL
4000	EL.	●	1T5906EL
4000	EL.	●	1T5907EL
4000	DALI	○	1T5905DA
4000	DALI	●	1T5906DA
4000	DALI	●	1T5907DA

Suspension installation kit: power cable complete with a painted polycarbonate rosette.

Max 0.6kW.

LOGICO

Accessories

Electrical Connector

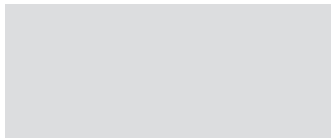

Code

1T5911

Linear electrical connector.

Control systems

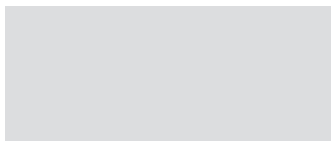

Code

1T5349

Wireless control unit for DALI fixtures.
It generates a local DALI bus that can control individual fixtures.
The module can be connected to an existing DALI network.
The module is wireless controlled using a Casambi app for smartphones and tablets using Bluetooth 4.0 technology.
The devices create a wireless mesh network that can control up to 128 fixtures.
IP20.

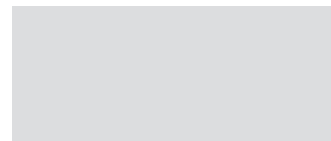

Code

1T5352

IP20 Extender for wireless control of DALI fixtures.
It generates a local DALI bus with the capacity to drive up to 64 fixtures.
Can control DALI fixtures in indoor applications.
It is also equipped with a relay that can control non-dimmable fixtures up to a maximum of 6A.

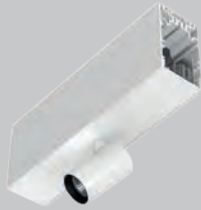

System Trimless Recessed - projector module Label 4

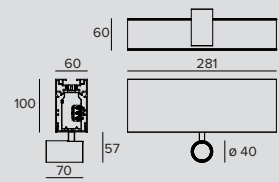

LED / 1x8W / SP



	3000K	H(m)	D(m)	E _{max} (lx)		
	Ra90		18°			
	Fixture Power	9W	1	0.31	4214	
	Source Flux	982lm	2	0.62	1053	
	Fixture Flux	622lm	3	0.93	468	
	Efficacy	71lm/W	4	1.24	263	
TS1165	I _{max} =4291cd/klm	I _{max}	4214cd	5	1.55	169

Driver	Colour	3000K	4000K
EL.	○	1T7197EL	1T7200EL
EL.	●	1T7203EL	1T7206EL
DALI	○	1T7197DA	1T7200DA
DALI	●	1T7203DA	1T7206DA

LED / 1x8W / FL



	3000K	H(m)	D(m)	E _{max} (lx)		
	Ra90		27°			
	Fixture Power	9W	1	0.48	3199	
	Source Flux	1129lm	2	0.95	800	
	Fixture Flux	806lm	3	1.43	355	
	Efficacy	92lm/W	4	1.91	200	
TS1166	I _{max} =2834cd/klm	I _{max}	3199cd	5	2.38	128

Driver	Colour	3000K	4000K
EL.	○	1T7198EL	1T7201EL
EL.	●	1T7204EL	1T7207EL
DALI	○	1T7198DA	1T7201DA
DALI	●	1T7204DA	1T7207DA

LED / 1x8W / MWFL



	3000K	H(m)	D(m)	E _{max} (lx)		
	Ra90		42°			
	Fixture Power	9W	1	0.76	1831	
	Source Flux	1129lm	2	1.52	458	
	Fixture Flux	835lm	3	2.28	203	
	Efficacy	95lm/W	4	3.04	114	
TS1167	I _{max} =1622cd/klm	I _{max}	1831cd	5	3.80	73

Driver	Colour	3000K	4000K
EL.	○	1T7199EL	1T7202EL
EL.	●	1T7205EL	1T7208EL
DALI	○	1T7199DA	1T7202DA
DALI	●	1T7205DA	1T7208DA



System Trimless Recessed - projector module Label 4

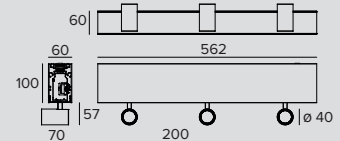

LED / 3x8W / SP



	3000K	H(m)	D(m)	E _{max} (lx)		
	Ra90		18°			
	Fixture Power	9W	1	0.31	4214	
	Source Flux	982lm	2	0.62	1053	
	Fixture Flux	622lm	3	0.93	468	
	Efficacy	71lm/W	4	1.24	263	
TS1165	I _{max} =4291cd/klm	I _{max}	4214cd	5	1.55	169

Driver	Colour	3000K	4000K
EL.	○	1T7209EL	1T7212EL
EL.	●	1T7215EL	1T7218EL
DALI	○	1T7209DA	1T7212DA
DALI	●	1T7215DA	1T7218DA

LED / 3x8W / FL



		3000K	H(m)	D(m)	E _{max} (lx)
Ra90				27°	
Fixture Power	9W	1	0.48	3199	
Source Flux	1129lm	2	0.95	800	
Fixture Flux	806lm	3	1.43	355	
Efficacy	92lm/W	4	1.91	200	
TS1166	I _{max} =2834cd/klm	I _{max}	3199cd	5	2.38
					128

Driver	Colour	3000K	4000K
EL.	○	1T7210EL	1T7213EL
EL.	●	1T7216EL	1T7219EL
DALI	○	1T7210DA	1T7213DA
DALI	●	1T7216DA	1T7219DA

LED / 3x8W / MWFL



		3000K	H(m)	D(m)	E _{max} (lx)
Ra90				42°	
Fixture Power	9W	1	0.76	1831	
Source Flux	1129lm	2	1.52	458	
Fixture Flux	835lm	3	2.28	203	
Efficacy	95lm/W	4	3.04	114	
TS1167	I _{max} =1622cd/klm	I _{max}	1831cd	5	3.80
					73

Driver	Colour	3000K	4000K
EL.	○	1T7211EL	1T7214EL
EL.	●	1T7217EL	1T7220EL
DALI	○	1T7211DA	1T7214DA
DALI	●	1T7217DA	1T7220DA

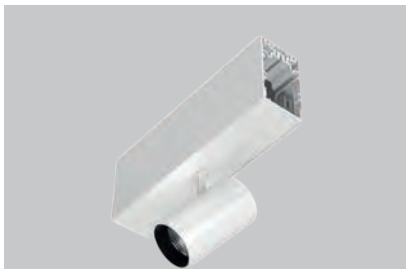

System Trimless Recessed - projector module Label 6

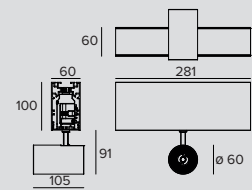

LED / 1x14W / SP



		3000K	H(m)	D(m)	E _{max} (lx)
Ra90				16°	
Fixture Power	15W	1	0.28	10741	
Source Flux	1793lm	2	0.55	2685	
Fixture Flux	1316lm	3	0.83	1193	
Efficacy	91lm/W	4	1.11	671	
TS1168	I _{max} =5990cd/klm	I _{max}	10741cd	5	1.39
					430

Driver	Colour	3000K	4000K
EL.	○	1T7281EL	1T7284EL
EL.	●	1T7287EL	1T7290EL
DALI	○	1T7281DA	1T7284DA
DALI	●	1T7287DA	1T7290DA

LED / 1x14W / FL



		3000K	H(m)	D(m)	E _{max} (lx)
Ra90				31°	
Fixture Power	15W	1	0.56	4410	
Source Flux	1793lm	2	1.12	1102	
Fixture Flux	1386lm	3	1.67	490	
Efficacy	96lm/W	4	2.23	276	
TS813	I _{max} =2460cd/klm	I _{max}	4410cd	5	2.79
					176

Driver	Colour	3000K	4000K
EL.	○	1T7282EL	1T7285EL
EL.	●	1T7288EL	1T7291EL
DALI	○	1T7282DA	1T7285DA
DALI	●	1T7288DA	1T7291DA

LED / 1x14W / MWFL



		3000K	H(m)	D(m)	E _{max} (lx)
Ra90				48°	
Fixture Power	15W	1	0.88	2457	
Source Flux	1793lm	2	1.77	614	
Fixture Flux	1373lm	3	2.65	273	
Efficacy	95lm/W	4	3.53	154	
TS1170	I _{max} =1378cd/klm	I _{max}	2471cd	5	4.41
					98

Driver	Colour	3000K	4000K
EL.	○	1T7283EL	1T7286EL
EL.	●	1T7289EL	1T7292EL
DALI	○	1T7283DA	1T7286DA
DALI	●	1T7289DA	1T7292DA



System Trimless Recessed - projector module Label 6

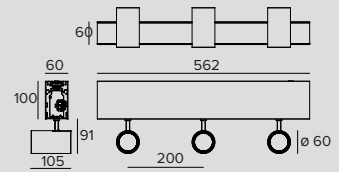

LED / 3x14W / SP ± 4.3 IP20

		3000K	H(m)	D(m)	E _{max} (lx)	
Ra90				16°		
Fixture Power	15W	1	0.28	10741		
Source Flux	1793lm	2	0.55	2685		
Fixture Flux	1316lm	3	0.83	1193		
Efficacy	91lm/W	4	1.11	671		
TS1168	Imax=5990cd/klm	Imax	10741cd	5	1.39	430

Driver	Colour	3000K	4000K
EL.	○	1T7293EL	1T7296EL
EL.	●	1T7299EL	1T7302EL
DALI	○	1T7293DA	1T7296DA
DALI	●	1T7299DA	1T7302DA

LED / 3x14W / FL ± 4.3 IP20

		3000K	H(m)	D(m)	E _{max} (lx)	
Ra90				31°		
Fixture Power	15W	1	0.56	4410		
Source Flux	1793lm	2	1.12	1102		
Fixture Flux	1386lm	3	1.67	490		
Efficacy	96lm/W	4	2.23	276		
TS813	Imax=2460cd/klm	Imax	4410cd	5	2.79	176

Driver	Colour	3000K	4000K
EL.	○	1T7294EL	1T7297EL
EL.	●	1T7300EL	1T7303EL
DALI	○	1T7294DA	1T7297DA
DALI	●	1T7300DA	1T7303DA

LED / 3x14W / MWFL ± 4.3 IP20

		3000K	H(m)	D(m)	E _{max} (lx)	
Ra90				48°		
Fixture Power	15W	1	0.88	2457		
Source Flux	1793lm	2	1.77	614		
Fixture Flux	1373lm	3	2.65	273		
Efficacy	95lm/W	4	3.53	154		
TS1170	Imax=1378cd/klm	Imax	2471cd	5	4.41	98

Driver	Colour	3000K	4000K
EL.	○	1T7295EL	1T7298EL
EL.	●	1T7301EL	1T7304EL
DALI	○	1T7295DA	1T7298DA
DALI	●	1T7301DA	1T7304DA

Note

Check mounting instructions to verify the quantity of DALI drivers installed.

LOGICO

Related codes

End Caps

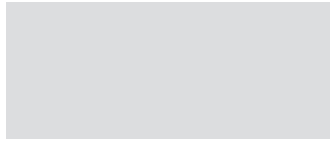

Colour	Code
○	1T5937
●	1T5938
●	1T5939

End caps for Ceiling Mounted, Suspension and Trimless versions.
2X

Insertion Box

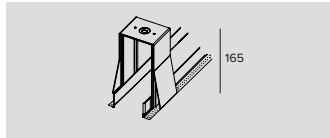

Kg	Cutout hole	L	Code
1.25	80x281	281	1T7369
1.8	80x562	562	1T6051
3.2	80x1122	1122	1T5915
3.8	80x1682	1682	1T5916

Outer casing for trimless installation.

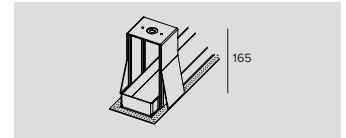

Kg	Cutout hole	L	Code
1.3	80x291	306	1T7370
1.9	80x572	587	1T6052
3.2	80x1132	1147	1T5917
3.8	80x1692	1707	1T5921

Terminal outer casing for trimless installation.

Accessories

Electrical Connector

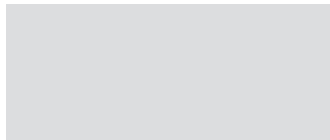

Code
1T5911

Linear electrical connector.

Control systems

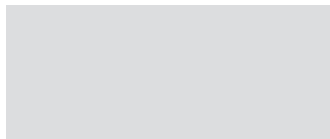

Code
1T5349

Wireless control unit for DALI fixtures.
It generates a local DALI bus that can control individual fixtures.
The module can be connected to an existing DALI network.
The module is wireless controlled using a Casambi app for smartphones and tablets using Bluetooth 4.0 technology.
The devices create a wireless mesh network that can control up to 128 fixtures.
IP20.

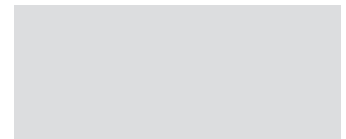

Code
1T5352

IP20 Extender for wireless control of DALI fixtures.
It generates a local DALI bus with the capacity to drive up to 64 fixtures.
Can control DALI fixtures in indoor applications.
It is also equipped with a relay that can control non-dimmable fixtures up to a maximum of 6A.



System Recessed with flange - projector module Label 4

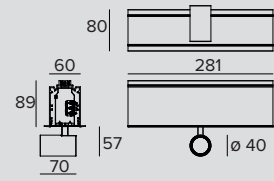

LED / 1x8W / SP



		3000K	H(m)	D(m)	E _{max} (lx)
		Ra90		18°	
Fixture Power	9W	1	0.31	4214	
Source Flux	982lm	2	0.62	1053	
Fixture Flux	622lm	3	0.93	468	
Efficacy	71lm/W	4	1.24	263	
TS1165	I _{max} =4291cd/klm	I _{max}	4214cd	5	1.55

Driver	Colour	3000K	4000K
EL.	○	1T7173EL	1T7176EL
DALI	○	1T7173DA	1T7176DA

LED / 1x8W / FL



		3000K	H(m)	D(m)	E _{max} (lx)
		Ra90		27°	
Fixture Power	9W	1	0.48	3199	
Source Flux	1129lm	2	0.95	800	
Fixture Flux	806lm	3	1.43	355	
Efficacy	92lm/W	4	1.91	200	
TS1166	I _{max} =2834cd/klm	I _{max}	3199cd	5	2.38

Driver	Colour	3000K	4000K
EL.	○	1T7174EL	1T7177EL
DALI	○	1T7174DA	1T7177DA

LED / 1x8W / MWFL



		3000K	H(m)	D(m)	E _{max} (lx)
		Ra90		42°	
Fixture Power	9W	1	0.76	1831	
Source Flux	1129lm	2	1.52	458	
Fixture Flux	835lm	3	2.28	203	
Efficacy	95lm/W	4	3.04	114	
TS1167	I _{max} =1622cd/klm	I _{max}	1831cd	5	3.80

Driver	Colour	3000K	4000K
EL.	○	1T7175EL	1T7178EL
DALI	○	1T7175DA	1T7178DA



System Recessed with flange - projector module Label 4

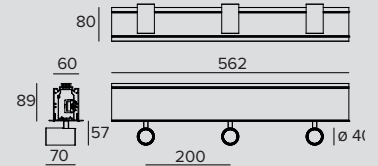

LED / 3x8W / SP



		3000K	H(m)	D(m)	E _{max} (lx)
		Ra90		18°	
Fixture Power	9W	1	0.31	4214	
Source Flux	982lm	2	0.62	1053	
Fixture Flux	622lm	3	0.93	468	
Efficacy	71lm/W	4	1.24	263	
TS1165	I _{max} =4291cd/klm	I _{max}	4214cd	5	1.55

Driver	Colour	3000K	4000K
EL.	○	1T7185EL	1T7188EL
DALI	○	1T7185DA	1T7188DA

LOGICO

LED / 3x8W / FL



		3000K	H(m)	D(m)	E _{max} (lx)
Ra90				27°	
Fixture Power	9W	1	0.48	3199	
Source Flux	1129lm	2	0.95	800	
Fixture Flux	806lm	3	1.43	355	
Efficacy	92lm/W	4	1.91	200	
TS1166	I _{max} =2834cd/klm	I _{max}	3199cd	5	2.38

Driver	Colour	3000K	4000K
EL.	○	1T7186EL	1T7189EL
DALI	○	1T7186DA	1T7189DA

LED / 3x8W / MWFL



		3000K	H(m)	D(m)	E _{max} (lx)
Ra90				42°	
Fixture Power	9W	1	0.76	1831	
Source Flux	1129lm	2	1.52	458	
Fixture Flux	835lm	3	2.28	203	
Efficacy	95lm/W	4	3.04	114	
TS1167	I _{max} =1622cd/klm	I _{max}	1831cd	5	3.80

Driver	Colour	3000K	4000K
EL.	○	1T7187EL	1T7190EL
DALI	○	1T7187DA	1T7190DA



System Recessed with flange - projector module Label 6

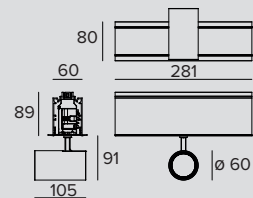

LED / 1x14W / SP



		3000K	H(m)	D(m)	E _{max} (lx)
Ra90				16°	
Fixture Power	15W	1	0.28	10741	
Source Flux	1793lm	2	0.55	2685	
Fixture Flux	1316lm	3	0.83	1193	
Efficacy	91lm/W	4	1.11	671	
TS1168	I _{max} =5990cd/klm	I _{max}	10741cd	5	1.39

Driver	Colour	3000K	4000K
EL.	○	1T7257EL	1T7260EL
DALI	○	1T7257DA	1T7260DA

LED / 1x14W / FL



		3000K	H(m)	D(m)	E _{max} (lx)
Ra90				31°	
Fixture Power	15W	1	0.56	4410	
Source Flux	1793lm	2	1.12	1102	
Fixture Flux	1386lm	3	1.67	490	
Efficacy	96lm/W	4	2.23	276	
TS813	I _{max} =2460cd/klm	I _{max}	4410cd	5	2.79

Driver	Colour	3000K	4000K
EL.	○	1T7258EL	1T7261EL
DALI	○	1T7258DA	1T7261DA

LED / 1x14W / MWFL



		3000K	H(m)	D(m)	E _{max} (lx)
Ra90				48°	
Fixture Power	15W	1	0.88	2457	
Source Flux	1793lm	2	1.77	614	
Fixture Flux	1373lm	3	2.65	273	
Efficacy	95lm/W	4	3.53	154	
TS1170	I _{max} =1378cd/klm	I _{max}	2471cd	5	4.41

Driver	Colour	3000K	4000K
EL.	○	1T7259EL	1T7262EL
DALI	○	1T7259DA	1T7262DA



System Recessed with flange - projector module Label 6

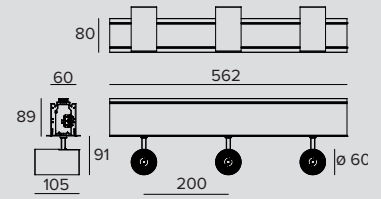

LED / 3x14W / SP									
	3000K	H(m)	D(m)	Emax(lx)	Driver	Colour	3000K	4000K	
	Ra90		15°		EL.	○	1T7269EL	1T7272EL	
	Fixture Power	15W	1	0.28	10741	DALI	○	1T7269DA	1T7272DA
	Source Flux	1793lm	2	0.55	2685				
	Fixture Flux	1316lm	3	0.83	1193				
	Efficacy	91lm/W	4	1.11	671				
TS1168	Imax=5990cd/klm	Imax	10741cd	5	1.39	430			

LED / 3x14W / FL									
	3000K	H(m)	D(m)	Emax(lx)	Driver	Colour	3000K	4000K	
	Ra90		31°		EL.	○	1T7270EL	1T7273EL	
	Fixture Power	15W	1	0.56	4410	DALI	○	1T7270DA	1T7273DA
	Source Flux	1793lm	2	1.12	1102				
	Fixture Flux	1386lm	3	1.67	490				
	Efficacy	96lm/W	4	2.23	276				
TS813	Imax=2460cd/klm	Imax	4410cd	5	2.79	176			

LED / 3x14W / MWFL									
	3000K	H(m)	D(m)	Emax(lx)	Driver	Colour	3000K	4000K	
	Ra90		48°		EL.	○	1T7271EL	1T7274EL	
	Fixture Power	15W	1	0.88	2457	DALI	○	1T7271DA	1T7274DA
	Source Flux	1793lm	2	1.77	614				
	Fixture Flux	1373lm	3	2.65	273				
	Efficacy	95lm/W	4	3.53	154				
TS1170	Imax=1378cd/klm	Imax	2471cd	5	4.41	98			

Note

Check mounting instructions to verify the quantity of DALI drivers installed.

Related codes

End Caps	
	Code
	1T5908
End caps for the recessed version with a flange.	
White.	
2X	

LOGICO

Accessories

Electrical Connector

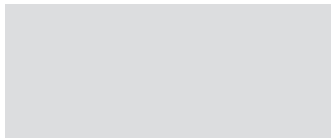

Code

1T5911

Linear electrical connector.

Control systems

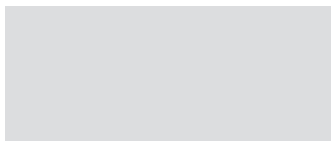

Code

1T5349

Wireless control unit for DALI fixtures.
It generates a local DALI bus that can control individual fixtures.
The module can be connected to an existing DALI network.
The module is wireless controlled using a Casambi app for smartphones and tablets using Bluetooth 4.0 technology.
The devices create a wireless mesh network that can control up to 128 fixtures.
IP20.

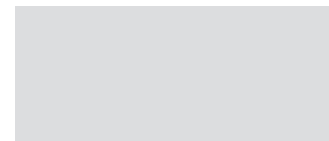

Code

1T5352

IP20 Extender for wireless control of DALI fixtures.
It generates a local DALI bus with the capacity to drive up to 64 fixtures.
Can control DALI fixtures in indoor applications.
It is also equipped with a relay that can control non-dimmable fixtures up to a maximum of 6A.

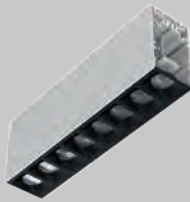

System Ceiling/ Suspension - spot module L. 281mm

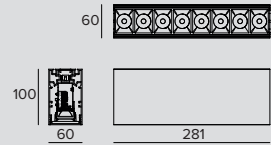

LED / 11,5W / LENSES / SP



	3000K	H(m)	D(m)	Emax(lx)		
	Ra90		11°			
	Fixture Power	13W	1	0.20	18466	
	Source Flux	1487lm	2	0.40	4617	
	Fixture Flux	1107lm	3	0.60	2052	
	Efficacy	84lm/W	4	0.79	1154	
TS1178	Imax=12421cd/km	Imax	18466cd	5	0.99	739

Driver	Colour	3000K	4000K
EL.	○	1T7349EL	1T7350EL
EL.	●	1T7351EL	1T7352EL
EL.	●	1T7353EL	1T7354EL
DALI	○	1T7349DA	1T7350DA
DALI	●	1T7351DA	1T7352DA
DALI	●	1T7353DA	1T7354DA



System Ceiling/ Suspension - spot module L. 562mm

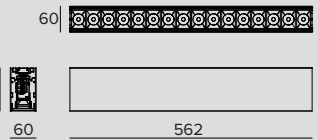

LED / 23W / LENSES / SP



	3000K	H(m)	D(m)	Emax(lx)		
	Ra90		11°			
	Fixture Power	26W	1	0.20	36933	
	Source Flux	2973lm	2	0.40	9233	
	Fixture Flux	2214lm	3	0.60	4104	
	Efficacy	85lm/W	4	0.79	2308	
TS1178	Imax=12421cd/km	Imax	36933cd	5	0.99	1477

Driver	Colour	3000K	4000K
EL.	○	1T7363EL	1T7364EL
EL.	●	1T7365EL	1T7366EL
EL.	●	1T7367EL	1T7368EL
DALI	○	1T7363DA	1T7364DA
DALI	●	1T7365DA	1T7366DA
DALI	●	1T7367DA	1T7368DA

Note

Check mounting instructions to verify the quantity of DALI drivers installed.

Related codes

End Caps

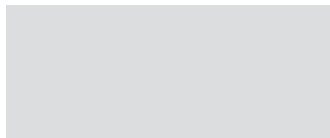

Colour	Code
○	1T5937
●	1T5938
●	1T5939

End caps for Ceiling Mounted, Suspension and Trimless versions.
2X

LOGICO

Mounting System

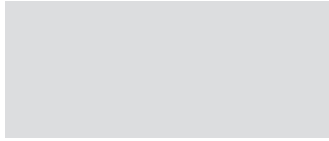
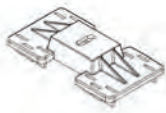

Colour	Code
	1T5912
	1T5913
	1T5914

Ceiling installation: polycarbonate bracket.
To be ordered in the following quantities for every fixture length: 1 for 281mm version, 2 for the 562 / 1122 / 1135 / 1682 / 1695mm version, 3 for the 3364 / 3377mm version, 3 for the L/T version and 4 for the X version.

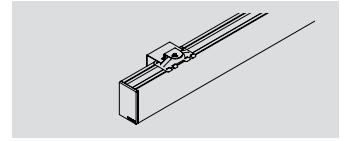
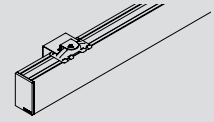

Colour	Code
	1T6919
	1T6920
	1T6921

Wall installation: painted metal bracket.
To be ordered in the following quantities for every fixture length: 1 for the 281mm version, 2 for the 562 / 1122 / 1135 / 1682 / 1695mm version and 3 for the 3364 / 3377mm version.

Suspension

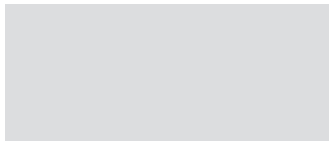

L	Colour	Code
2000		1T5899
2000		1T5900
2000		1T5901
4000		1T5902
4000		1T5903
4000		1T5904

Suspension cable.
To be ordered in the following quantities for every fixture length: 1 for 281mm version, 2 for the 562 / 1122 / 1135 / 1682 / 1695mm version, 3 for the 3364 / 3377mm version, 3 for the L/T version and 4 for the X version.
Suspension cable compatible with ceiling or wall installations, even inclined.

Power Supply Kit

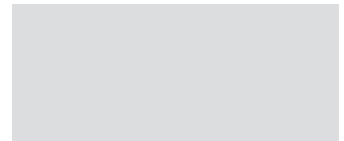

L	Driver	Colour	Code
4000	EL.		1T5905EL
4000	EL.		1T5906EL
4000	EL.		1T5907EL
4000	DALI		1T5905DA
4000	DALI		1T5906DA
4000	DALI		1T5907DA

Suspension installation kit: power cable complete with a painted polycarbonate rosette.
Max 0.6kW.

Accessories

Electrical Connector

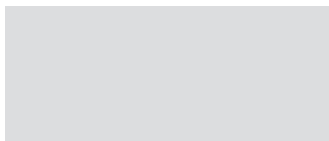

Code
1T5911

Linear electrical connector.

Control systems

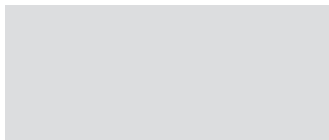

Code
1T5349

Wireless control unit for DALI fixtures.
It generates a local DALI bus that can control individual fixtures.
The module can be connected to an existing DALI network.
The module is wireless controlled using a Casambi app for smartphones and tablets using Bluetooth 4.0 technology.
The devices create a wireless mesh network that can control up to 128 fixtures.
IP20.

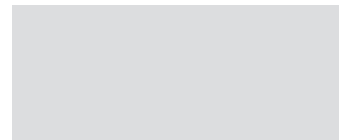

Code
1T5352

IP20 Extender for wireless control of DALI fixtures.
It generates a local DALI bus with the capacity to drive up to 64 fixtures.
Can control DALI fixtures in indoor applications.
It is also equipped with a relay that can control non-dimmable fixtures up to a maximum of 6A.

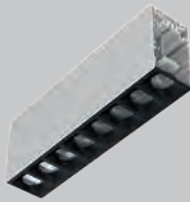

System Trimless Recessed spot module L. 281mm

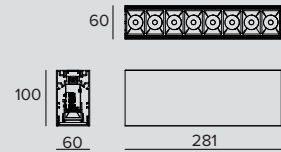

LED / 11,5W / LENSES / SP



	3000K	H(m)	D(m)	E _{max} (lx)		
	Ra90		11°			
	Fixture Power	13W	1	0.20	18466	
	Source Flux	1487lm	2	0.40	4617	
	Fixture Flux	1107lm	3	0.60	2052	
	Efficacy	84lm/W	4	0.79	1154	
TS1178	I _{max} =12421cd/klm	I _{max}	18466cd	5	0.99	739

Driver	Colour	3000K	4000K
EL.	○	1T7345EL	1T7346EL
EL.	●	1T7347EL	1T7348EL
DALI	○	1T7345DA	1T7346DA
DALI	●	1T7347DA	1T7348DA



System Trimless Recessed spot module L. 562mm

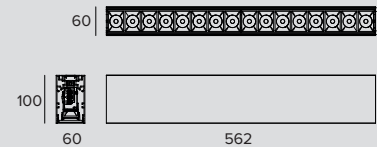

LED / 23W / LENSES / SP



	3000K	H(m)	D(m)	E _{max} (lx)		
	Ra90		11°			
	Fixture Power	26W	1	0.20	36933	
	Source Flux	2973lm	2	0.40	9233	
	Fixture Flux	2214lm	3	0.60	4104	
	Efficacy	85lm/W	4	0.79	2308	
TS1178	I _{max} =12421cd/klm	I _{max}	36933cd	5	0.99	1477

Driver	Colour	3000K	4000K
EL.	○	1T7359EL	1T7360EL
EL.	●	1T7361EL	1T7362EL
DALI	○	1T7359DA	1T7360DA
DALI	●	1T7361DA	1T7362DA

Note

Check mounting instructions to verify the quantity of DALI drivers installed.

Related codes

End Caps

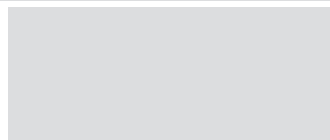

Colour	Code
○	1T5937
●	1T5938

End caps for Ceiling Mounted, Suspension and Trimless versions.

2X

LOGICO

Insertion Box

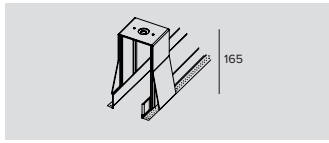

Kg	Cutout hole	L	Code
1.25	80x281	281	1T7369
1.8	80x562	562	1T6051

Outer casing for trimless installation.

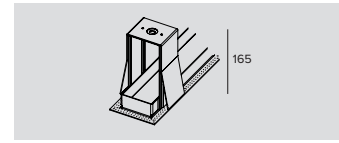

Kg	Cutout hole	L	Code
1.3	80x291	306	1T7370
1.9	80x572	587	1T6052

Terminal outer casing for trimless installation.

Accessories

Electrical Connector

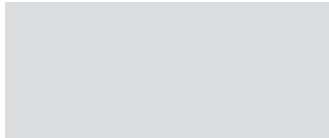

Code

1T5911

Linear electrical connector.

Control systems

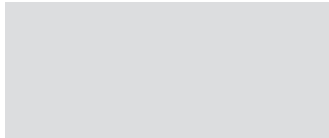

Code

1T5349

Wireless control unit for DALI fixtures.
It generates a local DALI bus that can control individual fixtures.
The module can be connected to an existing DALI network.
The module is wireless controlled using a Casambi app for smartphones and tablets using Bluetooth 4.0 technology.
The devices create a wireless mesh network that can control up to 128 fixtures.
IP20.

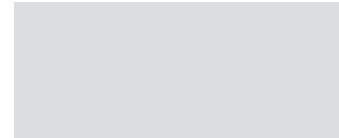

Code

1T5352

IP20 Extender for wireless control of DALI fixtures.
It generates a local DALI bus with the capacity to drive up to 64 fixtures.
Can control DALI fixtures in indoor applications.
It is also equipped with a relay that can control non-dimmable fixtures up to a maximum of 6A.



System Recessed with flange spot module L. 281mm

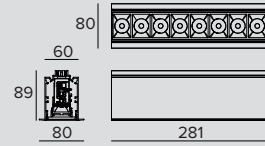

LED / 11,5W / LENSES / SP



	3000K	H(m)	D(m)	Emax(lx)		
	Ra90		11°			
	Fixture Power	13W	1	0.20	18466	
	Source Flux	1487lm	2	0.40	4617	
	Fixture Flux	1107lm	3	0.60	2052	
	Efficacy	84lm/W	4	0.79	1154	
TS1178	Imax=12421cd/klm	Imax	18466cd	5	0.99	739

Driver	Colour	3000K	4000K
EL.	○	1T7341EL	1T7342EL
DALI	○	1T7341DA	1T7342DA



System Recessed with flange spot module L. 562mm

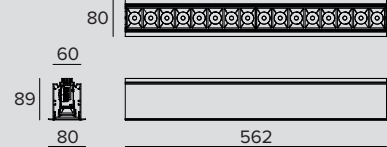

LED / 23W / LENSES / SP



	3000K	H(m)	D(m)	Emax(lx)		
	Ra90		11°			
	Fixture Power	26W	1	0.20	36933	
	Source Flux	2973lm	2	0.40	9233	
	Fixture Flux	2214lm	3	0.60	4104	
	Efficacy	85lm/W	4	0.79	2308	
TS1178	Imax=12421cd/klm	Imax	36933cd	5	0.99	1477

Driver	Colour	3000K	4000K
EL.	○	1T7355EL	1T7356EL
DALI	○	1T7355DA	1T7356DA

Note

Check mounting instructions to verify the quantity of DALI drivers installed.

Related codes

End Caps

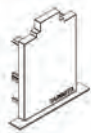

Code

1T5908

End caps for the recessed version with a flange.

White.

2X

LOGICO

Accessories

Electrical Connector



Code

1T5911

Linear electrical connector.

Control systems



Code

1T5349

Wireless control unit for DALI fixtures.
It generates a local DALI bus that can control individual fixtures.
The module can be connected to an existing DALI network.
The module is wireless controlled using a Casambi app for smartphones and tablets using Bluetooth 4.0 technology.
The devices create a wireless mesh network that can control up to 128 fixtures.
IP20.



Code

1T5352

IP20 Extender for wireless control of DALI fixtures.
It generates a local DALI bus with the capacity to drive up to 64 fixtures.
Can control DALI fixtures in indoor applications.
It is also equipped with a relay that can control non-dimmable fixtures up to a maximum of 6A.

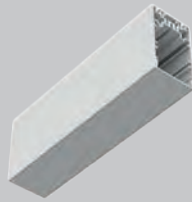

System Ceiling/ Suspension - blind module L. 281mm



LINEAR



Colour	Code
○	1T7385
●	1T7390
●	1T7395

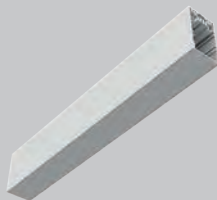

System Ceiling/ Suspension - blind module L. 562mm

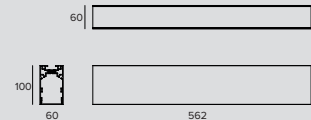

LINEAR



Colour	Code
○	1T7386
●	1T7391
●	1T7396



System Ceiling/ Suspension - blind module L connector

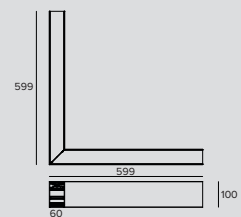

L CONNECTOR



Colour	Code
○	1T7387
●	1T7392
●	1T7397

LOGICO

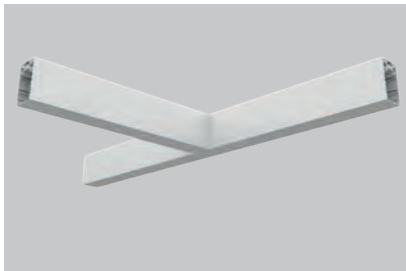

System Ceiling/ Suspension - blind module T connector



T CONNECTOR ⊕ 3,6 IP20

Colour	Code
○	1T7388
●	1T7393
●	1T7398

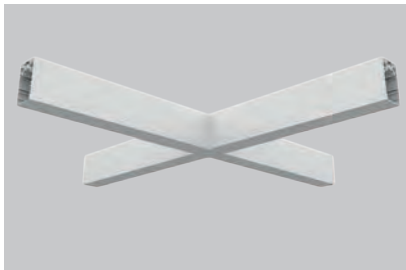

System Ceiling/ Suspension - blind module X connector

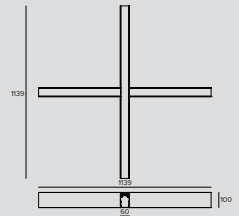

X CONNECTOR ⊕ 4,7 IP20

Colour	Code
○	1T7389
●	1T7394
●	1T7399

Related codes

End Caps

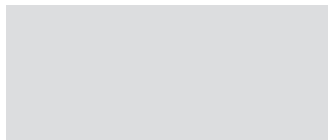

Colour	Code
○	1T5937
●	1T5938
●	1T5939

End caps for Ceiling Mounted, Suspension and Trimless versions.
2X

Mounting System

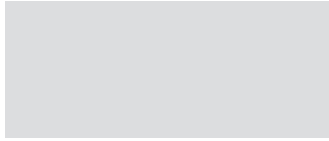

Colour	Code
	1T5912
	1T5913
	1T5914

Ceiling installation: polycarbonate bracket.

To be ordered in the following quantities for every fixture length: 1 for 281mm version, 2 for the 562 / 1122 / 1135 / 1682 / 1695mm version, 3 for the 3364 / 3377mm version, 3 for the L/T version and 4 for the X version.

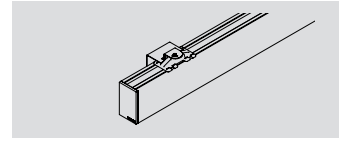
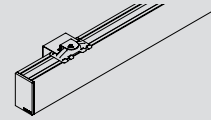

Colour	Code
	1T6919
	1T6920
	1T6921

Wall installation: painted metal bracket.

To be ordered in the following quantities for every fixture length: 1 for the 281mm version, 2 for the 562 / 1122 / 1135 / 1682 / 1695mm version and 3 for the 3364 / 3377mm version.

Suspension

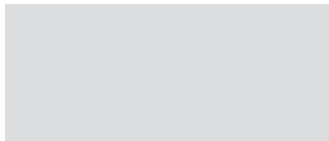

L	Colour	Code
2000		1T5899
2000		1T5900
2000		1T5901
4000		1T5902
4000		1T5903
4000		1T5904

Suspension cable.

To be ordered in the following quantities for every fixture length: 1 for 281mm version, 2 for the 562 / 1122 / 1135 / 1682 / 1695mm version, 3 for the 3364 / 3377mm version, 3 for the L/T version and 4 for the X version.

Suspension cable compatible with ceiling or wall installations, even inclined.

Accessories

Electrical Connector

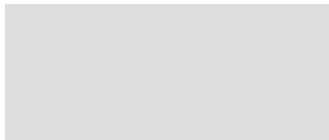

Code
1T5911

Linear electrical connector.

LOGICO



System Trimless Recessed - blind module L. 281mm

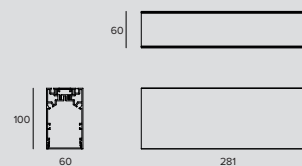

LINEAR ⊕ 0,7 IP20

Colour	Code
○	1T7381
●	1T7383

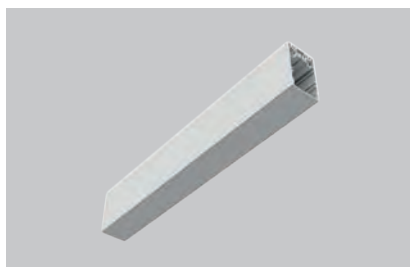

System Trimless Recessed - blind module L. 562mm

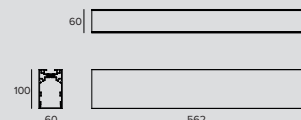

LINEAR ⊕ 1,4 IP20

Colour	Code
○	1T7382
●	1T7384

Related codes

End Caps

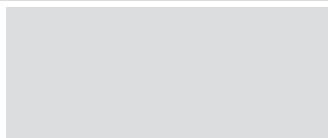

Colour	Code
○	1T5937
●	1T5938

End caps for Ceiling Mounted, Suspension and Trimless versions.
2X

Insertion Box

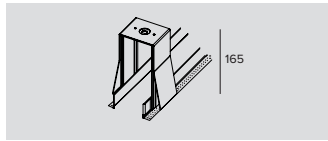

Kg	Cutout hole	L	Code
1.25	80x281	281	1T7369
1.8	80x562	562	1T6051

Outer casing for trimless installation.

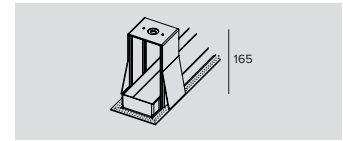

Kg	Cutout hole	L	Code
1.3	80x291	306	1T7370
1.9	80x572	587	1T6052

Terminal outer casing for trimless installation.

Accessories

Electrical Connector

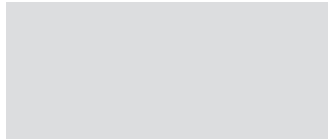

Code
1T5911

Linear electrical connector.

LOGICO



System Recessed with flange - blind module L. 281mm

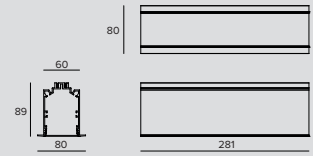

LINEAR		Colour	Code
		○	1T7371



System Recessed with flange - blind module L. 562mm

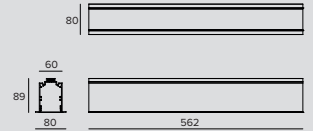

LINEAR		Colour	Code
		○	1T7372



System Recessed with flange - blind module L connector

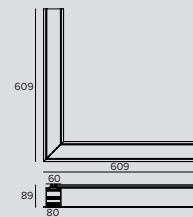

L CONNECTOR		Colour	Code
		○	1T7373

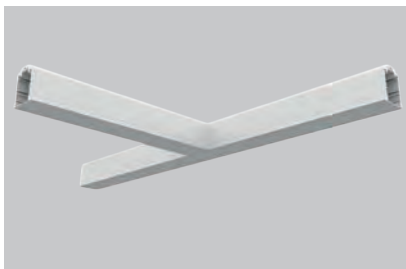

System Recessed with flange - blind module T connector

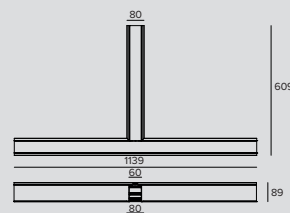

T CONNECTOR

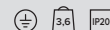

Colour

Code



1T7374



System Recessed with flange - blind module X connector

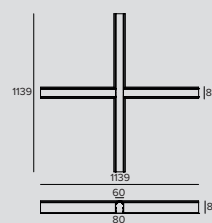

X CONNECTOR

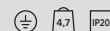

Colour

Code



1T7375

Related codes

End Caps



Code

1T5908

End caps for the recessed version with a flange.
White.
2X

Accessories

Electrical Connector



Code

1T5911

Linear electrical connector.

Indoor

**Ceiling and
Suspensions lumineaires**

Linear Ceiling and Suspensions luminaires



436
ISO



442
OMEGA



448
LOGICO
Stand alone



456
CARTESIO

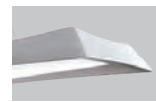

460
DIVA



464
SLIM



468
MINIMINIMA

Ceiling and Suspensions luminaires



470
OZ
Stand alone



476
THREESIXTY



488
PANTHEON



494
CCTLED
Pendant



496
CCTLED
Tube



506
BEBOP



508
GLOBO



510
WASABI



512
DECANter



514
MONETA

ISO

GENERAL INFO

Stand-alone linear LED fixture for suspension installation.

2144x70x73mm

LED

LED Engine made of linear boards

From 2137 to 4845lm

2700K – 3000K – 3500K – 4000K

Ra90

PRODUCT EFFICACY

Up to 120lm/W

OPTICS

Diffused light with an opal screen - Highly reflective brushed aluminium reflector and an opaline polycarbonate screen.

Controlled light UGR<19 (EN-12464) - Optical system composed of a highly reflective brushed aluminium reflector and a transparent polycarbonate screen coupled with a micro prismatic plate and a spreader lens.

POWER SUPPLY

Electronic – DALI

MATERIAL

Painted extruded aluminium body and a painted aluminium optical unit and terminal. Opaline polycarbonate or UGR screen.

New suspension fixture for office and hospitality environments designed in close collaboration with the American firm Gensler.

Available with direct or direct/indirect emission with two different effects: diffused light and controlled light UGR<19.

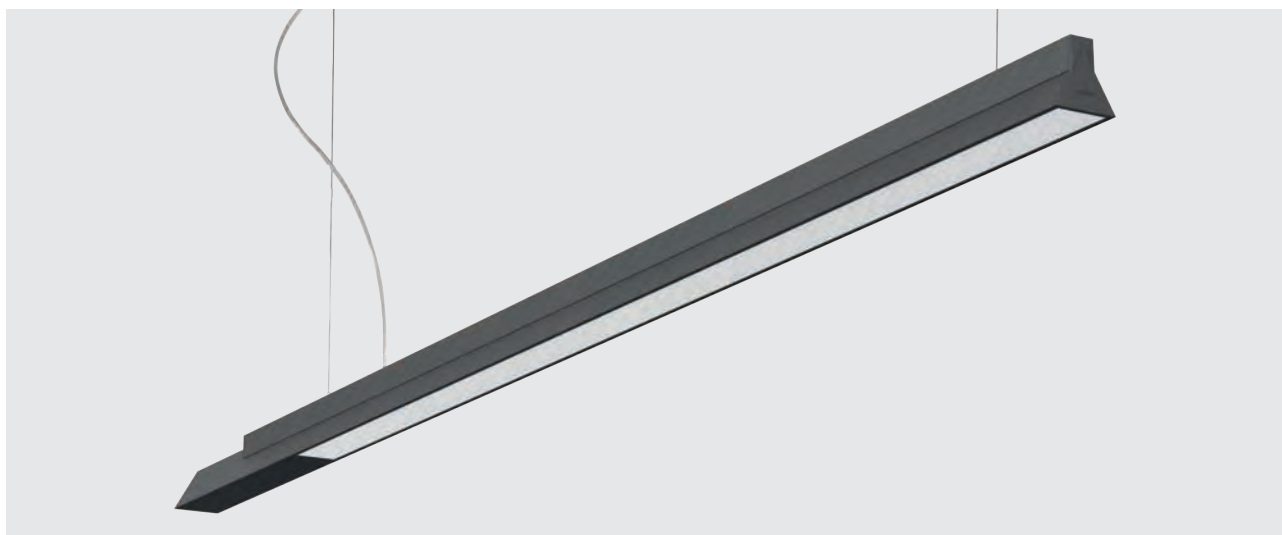



The two different optical systems it can use – OPAL and UGR – make it suitable for installation in OFFICE applications which are increasingly becoming open spaces, and in Hospitality projects which require not only visual comfort, but also attention to design and detail.



Design

The union between two pure forms, the co-penetration of two solids, has led to the creation of a unit that is both recognisable yet discrete, and which sits particularly well in contemporary environments, where the design of lighting plays an active role in the overall effect of each space.



UGR<19 optic

The UGR version is focused entirely on visual comfort. The colour rendering index of CRI 90 and the perfect UGR screening allows for a pleasant and measured light.

The sophisticated optical system, comprised of a mirrored reflector and a particular prismatic screen, reduces the shadows and reflections that can cause disturbance on work surfaces, allowing for an unrestricted distribution of desks without having to bear in mind the position of the lighting units.

Opal optic

The diffused effect of ISO OPAL is the result of a mirrored reflector with an opal screen. The light emitted appears soft and widespread, particularly suitable for reception areas in offices, hotels and spaces. In the direct/indirect light version, a line of light is present on the upper part, complete with diffusing screen to provide even light on the ceiling.

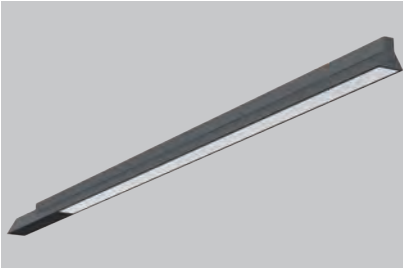

Suspension L. 2144mm

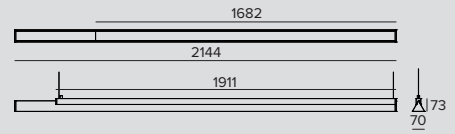

LED / 35W / DOWN OPAL



		3000K	H(m)	D(m)	E _{max} (lx)	
Ra90				106°		
Fixture Power	40W	1	2.66	1192		
Source Flux	4594lm	2	5.33	298		
Fixture Flux	3129lm	3	7.99	132		
Efficacy	78lm/W	4	10.65	74		
TS1206	I _{max} =259cd/klm	I _{max}	1192cd	5	13.32	48.

Driver	Colour	2700K	3000K	3500K	4000K
EL.	●	1T7179EL	1T7180EL	1T7181EL	1T7182EL
DALI	●	1T7179DA	1T7180DA	1T7181DA	1T7182DA

LED / 16W / DOWN UGR



		3000K	H(m)	D(m)	E _{max} (lx)	
Ra90				74°		
Fixture Power	18W	1	1.51	1469		
Source Flux	3326lm	2	3.02	367		
Fixture Flux	2153lm	3	4.52	163		
Efficacy	118lm/W	4	6.03	92		
TS1208	I _{max} =442cd/klm	I _{max}	1469cd	5	7.54	59

Driver	Colour	2700K	3000K	3500K	4000K
EL.	●	1T7193EL	1T7194EL	1T7195EL	1T7196EL
DALI	●	1T7193DA	1T7194DA	1T7195DA	1T7196DA

LED / 54W / UP-DOWN OPAL



		3000K	H(m)	D(m)	E _{max} (lx)	
Ra90				106°		
Fixture Power	61W	1	2.66	1214		
Source Flux	6951lm	2	5.33	304		
Fixture Flux	4724lm	3	7.99	135		
Efficacy	77lm/W	4	10.66	76		
TS1207	I _{max} =175cd/klm	I _{max}	1214cd	5	13.32	49

Driver	Colour	2700K	3000K	3500K	4000K
EL.	●	1T7183EL	1T7184EL	1T7191EL	1T7192EL
DALI	●	1T7183DA	1T7184DA	1T7191DA	1T7192DA

LED / 36W / UP-DOWN UGR



		3000K	H(m)	D(m)	E _{max} (lx)	
Ra90				72°		
Fixture Power	41W	1	1.45	1484		
Source Flux	4995lm	2	2.90	371		
Fixture Flux	3283lm	3	4.34	165		
Efficacy	80lm/W	4	5.79	93		
TS1209	I _{max} =297cd/klm	I _{max}	1484cd	5	7.24	59

Driver	Colour	2700K	3000K	3500K	4000K
EL.	●	1T7263EL	1T7264EL	1T7265EL	1T7266EL
DALI	●	1T7263DA	1T7264DA	1T7265DA	1T7266DA

Note: Kit of suspension is included

Accessories

Control systems

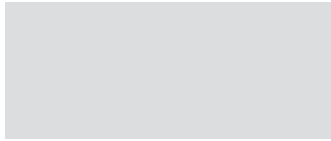

Code

1T5349

Wireless control unit for DALI fixtures.
It generates a local DALI bus that can control individual fixtures.
The module can be connected to an existing DALI network.
The module is wireless controlled using a Casambi app for smartphones and tablets using Bluetooth 4.0 technology.
The devices create a wireless mesh network that can control up to 128 fixtures.
IP20.

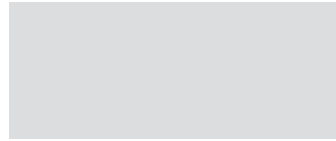

Code

1T5352

IP20 Extender for wireless control of DALI fixtures.
It generates a local DALI bus with the capacity to drive up to 64 fixtures.
Can control DALI fixtures in indoor applications.
It is also equipped with a relay that can control non-dimmable fixtures up to a maximum of 6A.

OMEGA

GENERAL INFO

Stand-alone linear LED fixture for surface or suspension installations.

2112x50x80mm

792x50x80mm

472x50x80mm

LED

LED Engine made of linear boards

From 586 to 2432lm

2700K – 3000K – 3500K – 4000K

Ra90

PRODUCT EFFICACY

Up to 120lm/W

OPTICS

Direct emission WFL

POWER SUPPLY

Electronic – DALI

MATERIAL

Anodized and painted extruded aluminium body.

Injection-moulded opal polycarbonate screen.

A new range of units made in close collaboration with the American firm Gensler, available in a range of sizes and forms of application for the coordinated lighting of spaces for hospitality and for common areas. Available in ceiling-mounted, suspension and wall-mounted versions.

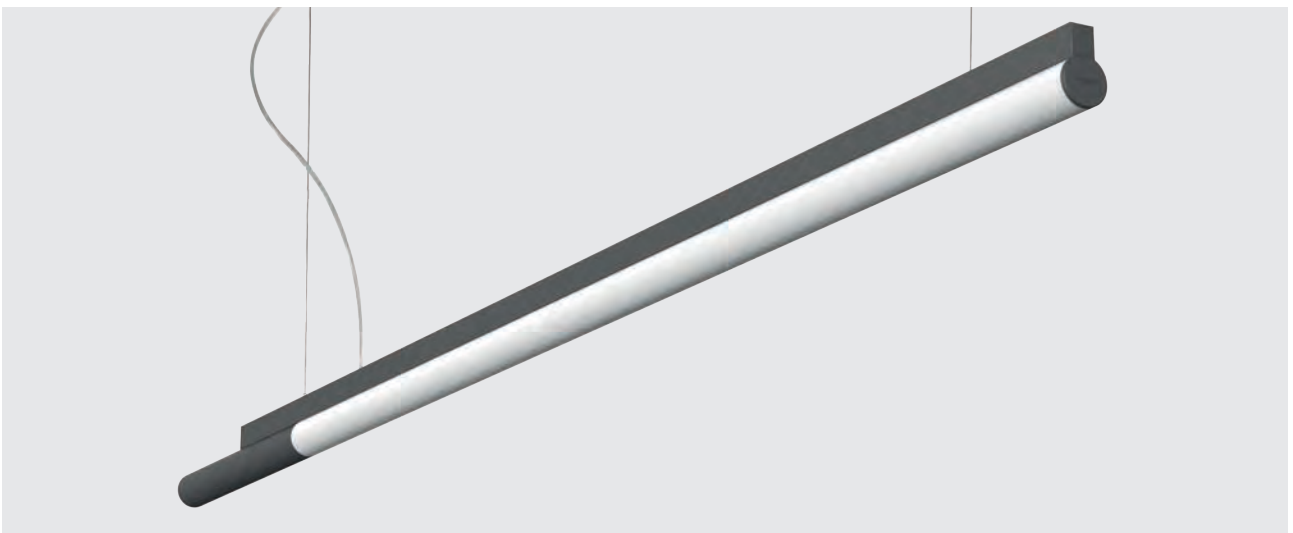



Suspension versions

The suspension versions are 2114 mm in length with a single direct point of emission, supplied complete with suspension kit.

01
OMEGA

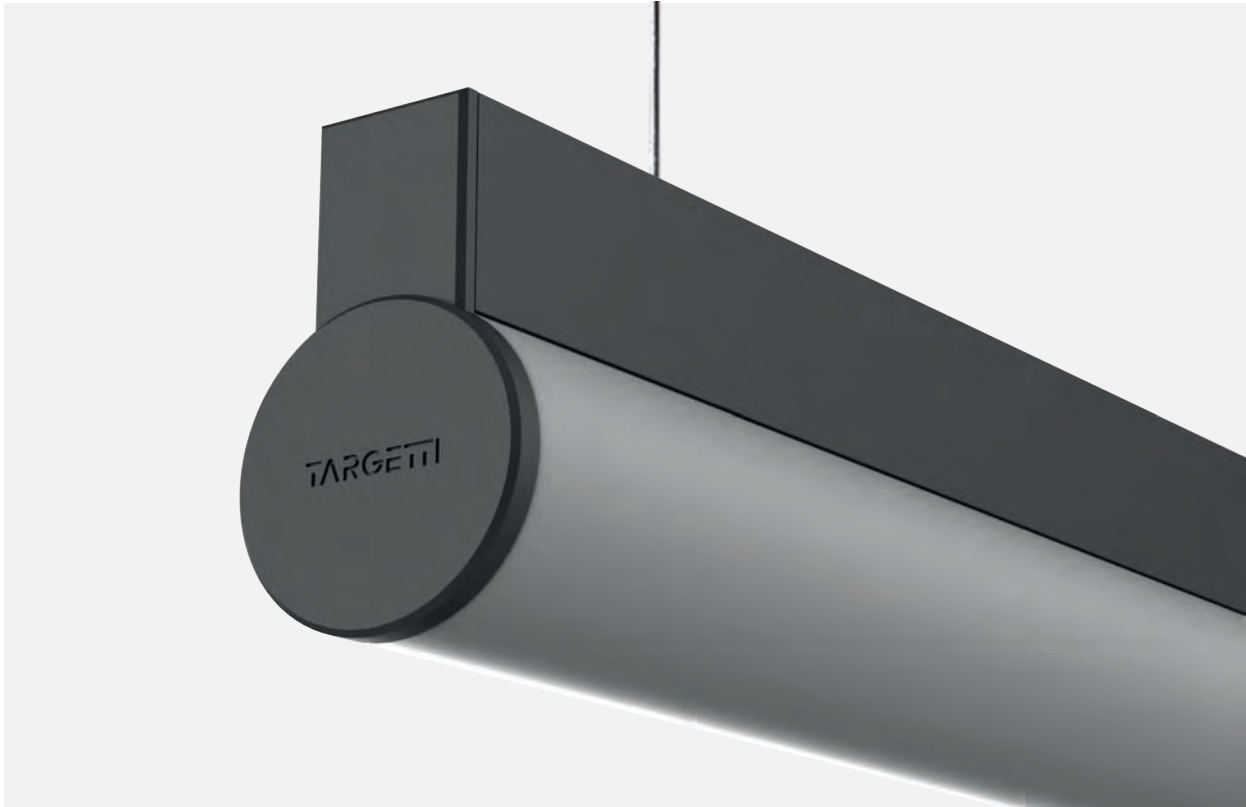

Design

A new 270° light emission that takes advantage of forms and the co-penetration of solids. An opal cylinder slots into a solid parallelepiped, providing a soft light that illuminates the space in all dimensions.

02



03

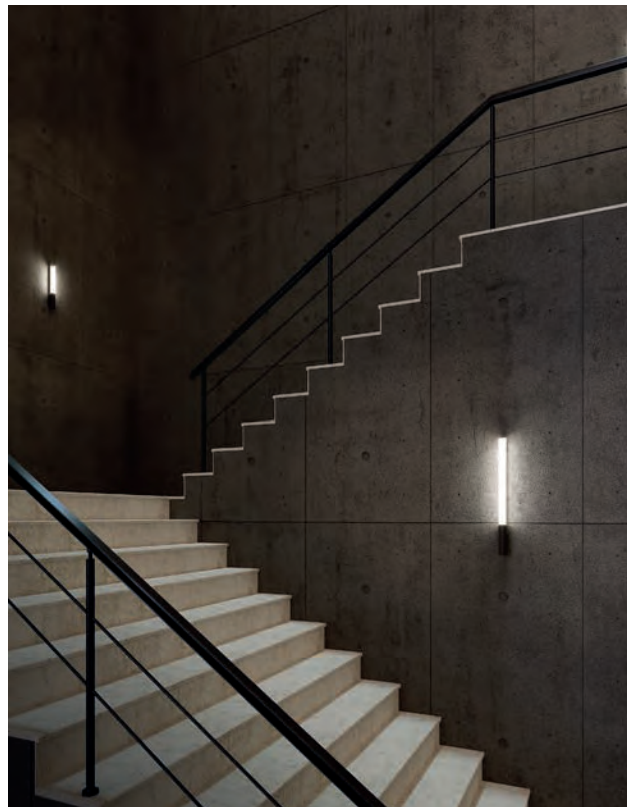

Wall-mounted version

The wall-mounted versions are available in two lengths (470 mm and 790 mm) and can be installed either horizontally or vertically. They are ideal for the lighting of common areas and stair wells, coordinated with the general lighting provided by the longer versions.

OMEGA

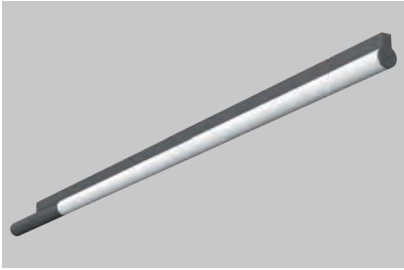

Suspension L. 2112mm

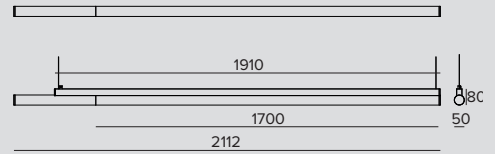

LED / 24W / DOWN OPAL						±	2.4	IP20				
	3000K	H(m)	D1(m)	D2(m)	E _{max} (lx)	Driver	Colour	2700K	3000K	3500K	4000K	
	Ra90		102*	164*		EL.	●	1T7267EL	1T7268EL	1T7275EL	1T7276EL	
	Fixture Power	27W	1	2.45	14.31	526	DALI	●	1T7267DA	1T7268DA	1T7275DA	1T7276DA
	Source Flux	4347lm	2	4.90	28.63	132						
	Fixture Flux	2371lm	3	7.35	42.94	58						
	Efficacy	88lm/W	4	9.80	57.25	33						
TS1199	I _{max} =121cd/klm	I _{max}	526cd	5	12.25	71.57	21					



Applique L. 472mm

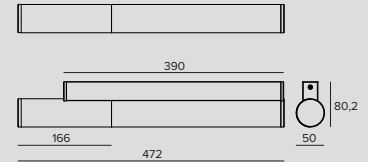

LED / 7,8W / DOWN OPAL						±	0.7	IP20				
	3000K	H(m)	D1(m)	D2(m)	E _{max} (lx)	Driver	Colour	2700K	3000K	3500K	4000K	
	Ra90		101*	163*		EL.	●	1T7277EL	1T7278EL	1T7279EL	1T7280EL	
	Fixture Power	9W	1	2.44	13.57	131	DALI	●	1T7277DA	1T7278DA	1T7279DA	1T7280DA
	Source Flux	1046lm	2	4.87	27.14	33						
	Fixture Flux	589lm	3	7.31	40.70	15						
	Efficacy	66lm/W	4	9.74	54.27	8						
TS1197	I _{max} =126cd/klm	I _{max}	132cd	5	12.18	67.84	5					



Applique L. 792mm

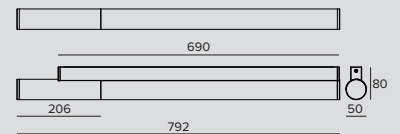

LED / 16W / DOWN OPAL						±	0.9	IP20				
	3000K	H(m)	D1(m)	D2(m)	E _{max} (lx)	Driver	Colour	2700K	3000K	3500K	4000K	
	Ra90		101*	163*		EL.	●	1T7343EL	1T7344EL	1T7357EL	1T7358EL	
	Fixture Power	18W	1	2.44	13.57	263	DALI	●	1T7343DA	1T7344DA	1T7357DA	1T7358DA
	Source Flux	2092lm	2	4.87	27.14	66						
	Fixture Flux	1178lm	3	7.31	40.70	29						
	Efficacy	67lm/W	4	9.74	54.27	16						
TS1198	I _{max} =126cd/klm	I _{max}	263cd	5	12.18	67.84	11					

Note: Kit of Suspension is included.

Accessories

Control systems

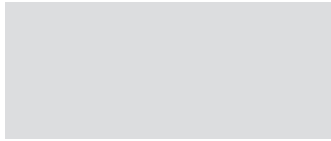

Code

1T5349

Wireless control unit for DALI fixtures.
It generates a local DALI bus that can control individual fixtures.
The module can be connected to an existing DALI network.
The module is wireless controlled using a Casambi app for smartphones and tablets using Bluetooth 4.0 technology.
The devices create a wireless mesh network that can control up to 128 fixtures.
IP20.

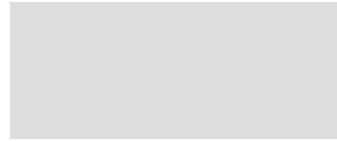

Code

1T5352

IP20 Extender for wireless control of DALI fixtures.
It generates a local DALI bus with the capacity to drive up to 64 fixtures.
Can control DALI fixtures in indoor applications.
It is also equipped with a relay that can control non-dimmable fixtures up to a maximum of 6A.

LOGICO

Stand Alone Ceiling and Suspension luminaire

GENERAL INFO

Modules of variable lengths for ceiling, suspension, recessed and semi-recessed installations.

Lengths: 1135mm – 1695mm – 3377mm

LED

Linear Board LED engine

From 2520lm to 28960lm

3000K – 4000K

Ra84

Ra90 To order this version it is necessary to add the suffix "90" at the end of the standard code.

PRODUCT EFFICACY

Up to 109lm/W

OPTICS

OPAL – UGR – WW

POWER SUPPLY

Electronic – DALI

Casambi control: the DALI version is fitted with special accessories.

Emergency version available on request.

MATERIAL

Powder coated, extruded, calendered aluminium.

A versatile fixture available in three different lengths, each with Low- Power and High-Power lumen and different finishes and installation types.

It can be ceiling, wall or suspension installation if equipped with special accessories; is it is available with direct or direct/indirect diffused light, UGR<19 controlled light ideal for lighting workplaces or wall-washer for lighting large vertical surfaces. There are also versions available for recessed installation. In addition there are custom made solutions that are available on request: modules with custom made lengths, emergency modules and Tunable technology.





Zonamerica

Architect
Estudio Dovat
Arquitectos

Lighting Design
Estudio Hofstadter

Photographer
Ferrés - Cánepa

Country
Montevideo,
Uruguay



Stand Alone Ceiling/ Suspension L. 1135mm

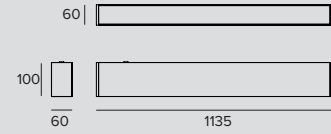

LED / 24W / DOWN OPAL



		3000K	H(m)	D(m)	E _{max} (lx)
Ra84				106°	
Fixture Power	27W	1	2.66	903	
Source Flux	3480lm	2	5.33	226	
Fixture Flux	2370lm	3	7.99	100	
Efficacy	88lm/W	4	10.65	56	
TS991	Imax=259cd/klm Imax	903cd	5	13.32	36

Driver	Colour	3000K	4000K
EL.	○	1T5491EL	1T5492EL
EL.	●	1T5495EL	1T5496EL
EL.	◐	1T5493EL	1T5494EL
DALI	○	1T5491DA	1T5492DA
DALI	●	1T5495DA	1T5496DA
DALI	◐	1T5493DA	1T5494DA

LED / 48W / DOWN OPAL



		3000K	H(m)	D(m)	E _{max} (lx)
Ra84				106°	
Fixture Power	54W	1	2.66	1785	
Source Flux	6880lm	2	5.33	446	
Fixture Flux	4685lm	3	7.99	198	
Efficacy	87lm/W	4	10.65	112	
TS996	Imax=259cd/klm Imax	1785cd	5	13.32	71

Driver	Colour	3000K	4000K
EL.	○	1T5497EL	1T5498EL
EL.	●	1T5501EL	1T5502EL
EL.	◐	1T5499EL	1T5500EL
DALI	○	1T5497DA	1T5498DA
DALI	●	1T5501DA	1T5502DA
DALI	◐	1T5499DA	1T5500DA

LED / 16W / DOWN UGR



		3000K	H(m)	D(m)	E _{max} (lx)
Ra84				74°	
Fixture Power	18W	1	1.51	1113	
Source Flux	2520lm	2	3.02	278	
Fixture Flux	1631lm	3	4.52	124	
Efficacy	91lm/W	4	6.03	70	
TS992	Imax=442cd/klm Imax	1113cd	5	7.54	45

Driver	Colour	3000K	4000K
EL.	○	1T5515EL	1T5516EL
EL.	●	1T5519EL	1T5520EL
EL.	◐	1T5517EL	1T5518EL
DALI	○	1T5515DA	1T5516DA
DALI	●	1T5519DA	1T5520DA
DALI	◐	1T5517DA	1T5518DA

LED / 24W / DOWN WW



		3000K	H(m)	D1(m)	D2(m)	E _{max} (lx)
Ra84				97°	101°	
Fixture Power	27W	1	2.28	2.55	2801	
Source Flux	3480lm	2	4.56	5.10	700	
Fixture Flux	2739lm	3	6.84	7.64	311	
Efficacy	101lm/W	4	9.12	10.19	175	
TS993	Imax=1001cd/klm Imax	3485cd	5	11.40	12.74	112

Driver	Colour	3000K	4000K
EL.	○	1T5527EL	1T5528EL
EL.	●	1T5531EL	1T5532EL
EL.	◐	1T5529EL	1T5530EL
DALI	○	1T5527DA	1T5528DA
DALI	●	1T5531DA	1T5532DA
DALI	◐	1T5529DA	1T5530DA

LED / 48W / DOWN WW



		3000K	H(m)	D1(m)	D2(m)	E _{max} (lx)
Ra84				97°	101°	
Fixture Power	54W	1	2.28	2.55	5537	
Source Flux	6880lm	2	4.56	5.10	1384	
Fixture Flux	5415lm	3	6.84	7.64	615	
Efficacy	100lm/W	4	9.12	10.19	346	
TS997	Imax=1001cd/klm Imax	6890cd	5	11.40	12.74	221

Driver	Colour	3000K	4000K
EL.	○	1T5533EL	1T5534EL
EL.	●	1T5537EL	1T5538EL
EL.	◐	1T5535EL	1T5536EL
DALI	○	1T5533DA	1T5534DA
DALI	●	1T5537DA	1T5538DA
DALI	◐	1T5535DA	1T5536DA

LED / 42W / UP-DOWN OPAL



		3000K	H(m)	D(m)	Emax(lx)	
Ra84				106°		
Fixture Power	47W	1	2.66	903		
Source Flux	6090lm	2	5.33	226		
Fixture Flux	4136lm	3	7.99	100		
Efficacy	88lm/W	4	10.65	56		
TS994	Imax=148cd/klm	Imax	903cd	5	13.32	36

Driver	Colour	3000K	4000K
EL.	○	1T5503EL	1T5504EL
EL.	●	1T5507EL	1T5508EL
EL.	◐	1T5505EL	1T5506EL
DALI	○	1T5503DA	1T5504DA
DALI	●	1T5507DA	1T5508DA
DALI	◐	1T5505DA	1T5506DA

LED / 66W / UP-DOWN OPAL



		3000K	H(m)	D(m)	Emax(lx)	
Ra84				106°		
Fixture Power	74W	1	2.66	1785		
Source Flux	9490lm	2	5.33	446		
Fixture Flux	6452lm	3	7.99	198		
Efficacy	87lm/W	4	10.65	112		
TS998	Imax=188cd/klm	Imax	1785cd	5	13.32	71

Driver	Colour	3000K	4000K
EL.	○	1T5509EL	1T5510EL
EL.	●	1T5513EL	1T5514EL
EL.	◐	1T5511EL	1T5512EL
DALI	○	1T5509DA	1T5510DA
DALI	●	1T5513DA	1T5514DA
DALI	◐	1T5511DA	1T5512DA

LED / 28W / UP-DOWN UGR



		3000K	H(m)	D(m)	Emax(lx)	
Ra84				74°		
Fixture Power	32W	1	1.51	1113		
Source Flux	4410lm	2	3.02	278		
Fixture Flux	2912lm	3	4.52	124		
Efficacy	91lm/W	4	6.03	70		
TS995	Imax=252cd/klm	Imax	1113cd	5	7.54	45

Driver	Colour	3000K	4000K
EL.	○	1T5521EL	1T5522EL
EL.	●	1T5525EL	1T5526EL
EL.	◐	1T5523EL	1T5524EL
DALI	○	1T5521DA	1T5522DA
DALI	●	1T5525DA	1T5526DA
DALI	◐	1T5523DA	1T5524DA

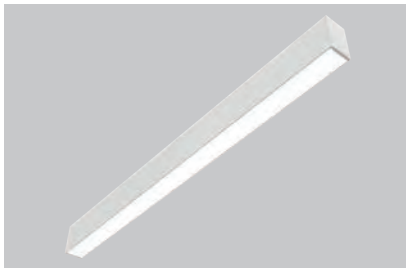

**Stand Alone Ceiling/
Suspension L. 1695mm**

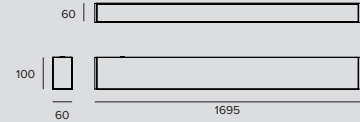

LED / 36W / DOWN OPAL



		3000K	H(m)	D(m)	Emax(lx)	
Ra84				106°		
Fixture Power	40W	1	2.66	1354		
Source Flux	5220lm	2	5.33	338		
Fixture Flux	3555lm	3	7.99	150		
Efficacy	89lm/W	4	10.65	85		
TS991	Imax=259cd/klm	Imax	1354cd	5	13.32	54

Driver	Colour	3000K	4000K
EL.	○	1T5539EL	1T5540EL
EL.	●	1T5543EL	1T5544EL
EL.	◐	1T5541EL	1T5542EL
DALI	○	1T5539DA	1T5540DA
DALI	●	1T5543DA	1T5544DA
DALI	◐	1T5541DA	1T5542DA

LED / 72W / DOWN OPAL



		3000K	H(m)	D(m)	Emax(lx)	
Ra84				106°		
Fixture Power	81W	1	2.66	2677		
Source Flux	10320lm	2	5.33	669		
Fixture Flux	7028lm	3	7.99	297		
Efficacy	87lm/W	4	10.65	167		
TS996	Imax=259cd/klm	Imax	2677cd	5	13.32	107

Driver	Colour	3000K	4000K
EL.	○	1T5545EL	1T5546EL
EL.	●	1T5549EL	1T5550EL
EL.	◐	1T5547EL	1T5548EL
DALI	○	1T5545DA	1T5546DA
DALI	●	1T5549DA	1T5550DA
DALI	◐	1T5547DA	1T5548DA

LOGICO

LED / 24W / DOWN UGR



		3000K	H(m)	D(m)	E _{max} (lx)	
Ra84				74°		
Fixture Power	27W	1	1.51	1669		
Source Flux	3780lm	2	3.02	417		
Fixture Flux	2447lm	3	4.52	185		
Efficacy	91lm/W	4	6.03	104		
TS992	I _{max} =442cd/klm	I _{max}	1669cd	5	7.54	67

Driver	Colour	3000K	4000K
EL.	○	1T5563EL	1T5564EL
EL.	●	1T5567EL	1T5568EL
EL.	●	1T5565EL	1T5566EL
DALI	○	1T5563DA	1T5564DA
DALI	●	1T5567DA	1T5568DA
DALI	●	1T5565DA	1T5566DA

LED / 36W / DOWN WW



		3000K	H(m)	D1(m)	D2(m)	E _{max} (lx)	
Ra84				97°	101°		
Fixture Power	40W	1	2.28	2.55	4201		
Source Flux	5220lm	2	4.56	5.10	1050		
Fixture Flux	4108lm	3	6.84	7.64	467		
Efficacy	103lm/W	4	9.12	10.19	263		
TS993	I _{max} =1001cd/klm	I _{max}	5228cd	5	11.40	12.74	168

Driver	Colour	3000K	4000K
EL.	○	1T5575EL	1T5576EL
EL.	●	1T5579EL	1T5580EL
EL.	●	1T5577EL	1T5578EL
DALI	○	1T5575DA	1T5576DA
DALI	●	1T5579DA	1T5580DA
DALI	●	1T5577DA	1T5578DA

LED / 72W / DOWN WW



		3000K	H(m)	D1(m)	D2(m)	E _{max} (lx)	
Ra84				97°	101°		
Fixture Power	81W	1	2.28	2.55	6305		
Source Flux	10320lm	2	4.56	5.10	2076		
Fixture Flux	8122lm	3	6.84	7.64	923		
Efficacy	100lm/W	4	9.12	10.19	519		
TS997	I _{max} =1001cd/klm	I _{max}	10335cd	5	11.40	12.74	332

Driver	Colour	3000K	4000K
EL.	○	1T5581EL	1T5582EL
EL.	●	1T5585EL	1T5586EL
EL.	●	1T5583EL	1T5584EL
DALI	○	1T5581DA	1T5582DA
DALI	●	1T5585DA	1T5586DA
DALI	●	1T5583DA	1T5584DA

LED / 60W / UP-DOWN OPAL



		3000K	H(m)	D(m)	E _{max} (lx)	
Ra84				106°		
Fixture Power	68W	1	2.66	1290		
Source Flux	8700lm	2	5.33	322		
Fixture Flux	5909lm	3	7.99	143		
Efficacy	87lm/W	4	10.65	81		
TS994	I _{max} =148cd/klm	I _{max}	1290cd	5	13.32	52

Driver	Colour	3000K	4000K
EL.	○	1T5551EL	1T5552EL
EL.	●	1T5555EL	1T5556EL
EL.	●	1T5553EL	1T5554EL
DALI	○	1T5551DA	1T5552DA
DALI	●	1T5555DA	1T5556DA
DALI	●	1T5553DA	1T5554DA

LED / 96W / UP-DOWN OPAL



		3000K	H(m)	D(m)	E _{max} (lx)	
Ra84				106°		
Fixture Power	107W	1	2.66	2595		
Source Flux	13800lm	2	5.33	649		
Fixture Flux	9382lm	3	7.99	288		
Efficacy	88lm/W	4	10.65	162		
TS998	I _{max} =188cd/klm	I _{max}	2595cd	5	13.32	104

Driver	Colour	3000K	4000K
EL.	○	1T5575EL	1T5576EL
EL.	●	1T5561EL	1T5562EL
EL.	●	1T5559EL	1T5560EL
DALI	○	1T5575DA	1T5576DA
DALI	●	1T5561DA	1T5562DA
DALI	●	1T5559DA	1T5560DA

LED / 40W / UP-DOWN UGR



		3000K	H(m)	D(m)	E _{max} (lx)	
Ra84				74°		
Fixture Power	45W	1	1.51	1590		
Source Flux	6300lm	2	3.02	398		
Fixture Flux	4160lm	3	4.52	177		
Efficacy	92lm/W	4	6.03	99		
TS995	I _{max} =252cd/klm	I _{max}	1590cd	5	7.54	64

Driver	Colour	3000K	4000K
EL.	○	1T5569EL	1T5570EL
EL.	●	1T5573EL	1T5574EL
EL.	●	1T5571EL	1T5572EL
DALI	○	1T5569DA	1T5570DA
DALI	●	1T5573DA	1T5574DA
DALI	●	1T5571DA	1T5572DA



Stand Alone Ceiling/Suspension L. 3377mm

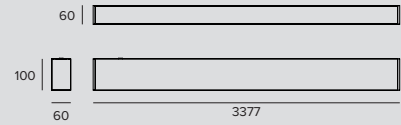

LED / 72W / DOWN OPAL



3000K		H(m)	D(m)	Emax(lx)
Ra84			106°	
Fixture Power	81W	1	2.66	2708
Source Flux	10440lm	2	5.33	677
Fixture Flux	7110lm	3	7.99	301
Efficacy	88lm/W	4	10.65	169
TS991	Imax=259cd/klm	Imax	2708cd	5
			13.32	108

Driver	Colour	3000K	4000K
EL.	○	1T5587EL	1T5588EL
EL.	●	1T5591EL	1T5592EL
EL.	●	1T5589EL	1T5590EL
DALI	○	1T5587DA	1T5588DA
DALI	●	1T5591DA	1T5592DA
DALI	●	1T5589DA	1T5590DA

LED / 144W / DOWN OPAL



3000K		H(m)	D(m)	Emax(lx)
Ra84			106°	
Fixture Power	163W	1	2.66	5354
Source Flux	20640lm	2	5.33	1338
Fixture Flux	14056lm	3	7.99	595
Efficacy	86lm/W	4	10.65	335
TS996	Imax=259cd/klm	Imax	5354cd	5
			13.32	214

Driver	Colour	3000K	4000K
EL.	○	1T5593EL	1T5594EL
EL.	●	1T5597EL	1T5598EL
EL.	●	1T5595EL	1T5596EL
DALI	○	1T5593DA	1T5594DA
DALI	●	1T5597DA	1T5598DA
DALI	●	1T5595DA	1T5596DA

LED / 48W / DOWN UGR



3000K		H(m)	D(m)	Emax(lx)
Ra84			74°	
Fixture Power	54W	1	1.51	3338
Source Flux	7560lm	2	3.02	834
Fixture Flux	4894lm	3	4.52	371
Efficacy	91lm/W	4	6.03	209
TS992	Imax=442cd/klm	Imax	3338cd	5
			7.54	134

Driver	Colour	3000K	4000K
EL.	○	1T5611EL	1T5612EL
EL.	●	1T5615EL	1T5616EL
EL.	●	1T5613EL	1T5614EL
DALI	○	1T5611DA	1T5612DA
DALI	●	1T5615DA	1T5616DA
DALI	●	1T5613DA	1T5614DA

LED / 72W / DOWN WW



3000K		H(m)	D1(m)	D2(m)	Emax(lx)
Ra84			97°	101°	
Fixture Power	81W	1	2.28	2.55	8402
Source Flux	10440lm	2	4.56	5.10	2101
Fixture Flux	8216lm	3	6.84	7.64	934
Efficacy	101lm/W	4	9.12	10.19	525
TS993	Imax=1001cd/klm	Imax	10455cd	5	
			11.40	12.74	336

Driver	Colour	3000K	4000K
EL.	○	1T5623EL	1T5624EL
EL.	●	1T5627EL	1T5628EL
EL.	●	1T5625EL	1T5626EL
DALI	○	1T5623DA	1T5624DA
DALI	●	1T5627DA	1T5628DA
DALI	●	1T5625DA	1T5626DA

LED / 144W / DOWN WW



3000K		H(m)	D1(m)	D2(m)	Emax(lx)
Ra84			97°	101°	
Fixture Power	163W	1	2.28	2.55	16611
Source Flux	20640lm	2	4.56	5.10	4153
Fixture Flux	16244lm	3	6.84	7.64	1846
Efficacy	100lm/W	4	9.12	10.19	1038
TS997	Imax=1001cd/klm	Imax	20670cd	5	
			11.40	12.74	664

Driver	Colour	3000K	4000K
EL.	○	1T5629EL	1T5630EL
EL.	●	1T5633EL	1T5634EL
EL.	●	1T5631EL	1T5632EL
DALI	○	1T5629DA	1T5630DA
DALI	●	1T5633DA	1T5634DA
DALI	●	1T5631DA	1T5632DA

Note

Check mounting instructions to verify the quantity of DALI drivers installed.

LED / 120W / UP-DOWN OPAL



		3000K	H(m)	D(m)	E _{max} (lx)
		Ra84			
		106°			
Fixture Power	136W	1	2.66	2579	
Source Flux	17400lm	2	5.33	645	
Fixture Flux	11818lm	3	7.99	287	
Efficacy	87lm/W	4	10.65	161	
TS994	l _{max} =148cd/klm	l _{max}	2579cd	5	13.32
					103

Driver	Colour	3000K	4000K
EL.	○	1T5599EL	1T5600EL
EL.	●	1T5603EL	1T5604EL
EL.	●	1T5601EL	1T5602EL
DALI	○	1T5599DA	1T5600DA
DALI	●	1T5603DA	1T5604DA
DALI	●	1T5601DA	1T5602DA

LED / 192W / UP-DOWN OPAL



		3000K	H(m)	D(m)	E _{max} (lx)
		Ra84			
		106°			
Fixture Power	218W	1	2.66	5183	
Source Flux	27560lm	2	5.33	1296	
Fixture Flux	18736lm	3	7.99	576	
Efficacy	86lm/W	4	10.65	324	
TS998	l _{max} =188cd/klm	l _{max}	5183cd	5	13.32
					207

Driver	Colour	3000K	4000K
EL.	○	1T5605EL	1T5606EL
EL.	●	1T5609EL	1T5610EL
EL.	●	1T5607EL	1T5608EL
DALI	○	1T5605DA	1T5606DA
DALI	●	1T5609DA	1T5610DA
DALI	●	1T5607DA	1T5608DA

LED / 80W / UP-DOWN UGR



		3000K	H(m)	D(m)	E _{max} (lx)
		Ra84			
		74°			
Fixture Power	91W	1	1.51	3181	
Source Flux	12600lm	2	3.02	795	
Fixture Flux	8320lm	3	4.52	353	
Efficacy	91lm/W	4	6.03	199	
TS995	l _{max} =252cd/klm	l _{max}	3181cd	5	7.54
					127

Driver	Colour	3000K	4000K
EL.	○	1T5617EL	1T5618EL
EL.	●	1T5621EL	1T5622EL
EL.	●	1T5619EL	1T5620EL
DALI	○	1T5617DA	1T5618DA
DALI	●	1T5621DA	1T5622DA
DALI	●	1T5619DA	1T5620DA

Note

Check mounting instructions to verify the quantity of DALI drivers installed.

Related codes

Mounting System

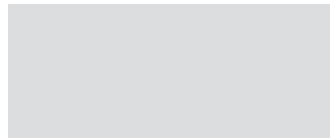

Colour	Code
○	1T5912
●	1T5913
●	1T5914

Ceiling installation: polycarbonate bracket.

To be ordered in the following quantities for every fixture length: 1 for the 281mm version, 2 for the 562 / 1122 / 1135 / 1682 / 1695mm version, 3 for the 3364 / 3377mm version, 3 for the L/T version and 4 for the X version.

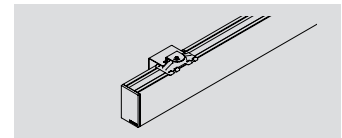

Colour	Code
○	1T6919
●	1T6920
●	1T6921

Wall installation: painted metal bracket.

To be ordered in the following quantities for every fixture length: 1 for the 281mm version, 2 for the 562 / 1122 / 1135 / 1682 / 1695mm version and 3 for the 3364 / 3377mm version.

Suspension



L	Colour	Code
2000	○	1T5899
2000	●	1T5900
2000	●	1T5901
4000	○	1T5902
4000	●	1T5903
4000	●	1T5904

Suspension cable.

To be ordered in the following quantities for every fixture length: 1 for 281mm version, 2 for the 562 / 1122 / 1135 / 1682 / 1695mm version, 3 for the 3364 / 3377mm version, 3 for the L/T version and 4 for the X version.

Suspension cable compatible with ceiling or wall installations, even inclined.

Power Supply Kit



L	Driver	Colour	Code
4000	EL.	○	1T5905EL
4000	EL.	●	1T5906EL
4000	EL.	●	1T5907EL
4000	DALI	○	1T5905DA
4000	DALI	●	1T5906DA
4000	DALI	●	1T5907DA

Suspension installation kit: power cable complete with a painted polycarbonate rosette.

Max 0.6kW.

Accessories

Screen

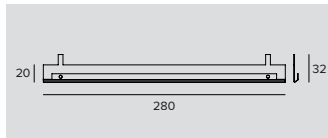

Code

1T6502

Accessory designed to improve the visual comfort of the Wall Washer version.

To be installed on a standard reflector.

Made of matte black painted aluminium.

280mm in length; to be ordered in the following quantities for every fixture length: 2 for the 562mm version, 4 for the 1122/1135/1146mm versions, 6 for the 1682/1695/1706mm versions and 12 for the 3364/3377/3386mm versions.

Control systems



Code

1T5349

Wireless control unit for DALI fixtures.

It generates a local DALI bus that can control individual fixtures.

The module can be connected to an existing DALI network.

The module is wireless controlled using a Casambi app for smartphones and tablets using Bluetooth 4.0 technology.

The devices create a wireless mesh network that can control up to 128 fixtures.

IP20.



Code

1T5352

IP20 Extender for wireless control of DALI fixtures.

It generates a local DALI bus with the capacity to drive up to 64 fixtures.

Can control DALI fixtures in indoor applications.

It is also equipped with a relay that can control non-dimmable fixtures up to a maximum of 6A.

CARTESIO

GENERAL INFO

Direct/indirect light suspension, ceiling mounted luminaire.

720x720x42mm

1147x420x42mm

LED

Direct lighting LED boards

Indirect lighting LED COB

Ra84

From 2776lm to 6833lm

3000K – 4000K

Ra84

PRODUCT EFFICACY

Up to 116lm/W

OPTICS

UGR

POWER SUPPLY

Electronic – DALI

MATERIAL

Extruded aluminium body with aluminium terminals.

Plaster white finish.

The range of technical suspension fixtures for the office environment with soft lines and professional performance. Square and rectangular solutions for suspension, ceiling mounted and wall mounted installations.

Different light emissions: direct, indirect and combined direct/indirect in just one fixture. Available in a UGR<19 version.



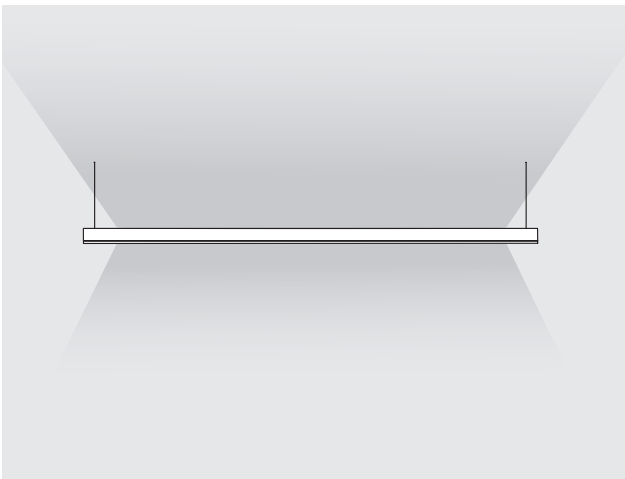

Lighting for the office

The rectangular CARTESIO versions, fitted with the direct emission component guarantee more than 500lux on the work surface, in line with the requirements outlined in the EN12464-1 standard and have a UGR value of 16 which is considerably lower than the limits indicated in the standard (UGR<19), which ensures reliability and maximum freedom when designing spaces. In addition to this there is the indirect component that contributes to softly balancing the luminance to reduce user eyestrain and improve perception of the illuminated space.



CARTESIO



Rectangular Suspension UGR<19

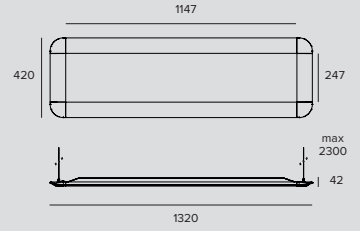

LED / 48W / UGR



		3000K	H(m)	D1(m)	D2(m)	E _{max} (lx)	
		Ra84		88°	92°		
Fixture Power		55W	1	1.95	2.08	1441	
Source Flux		6402lm	2	3.90	4.15	360	
Fixture Flux		6402lm	3	5.84	6.23	160	
Efficacy		116lm/W	4	7.79	8.30	90	
TS803	I _{max} =234cd/klm	I _{max}	1497cd	5	9.74	10.38	58

Driver	Colour	3000K
EL.	○	1T4063
DALI	○	1T4067

LED / 52W / UGR



		4000K	H(m)	D1(m)	D2(m)	E _{max} (lx)	
		Ra84		80°	82°		
Fixture Power		59W	1	1.67	1.75	2068	
Source Flux		6833lm	2	3.34	3.50	517	
Fixture Flux		6833lm	3	5.01	5.25	230	
Efficacy		116lm/W	4	6.67	7.00	129	
TS840	I _{max} =321cd/klm	I _{max}	2190cd	5	8.34	8.75	83

Driver	Colour	4000K
EL.	○	1T4065
DALI	○	1T4069



Square Suspension UGR<22

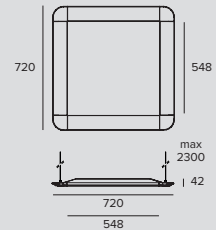

LED / 26W / VWFL



		3000K	H(m)	D(m)	E _{max} (lx)	
		Ra80		119°		
Fixture Power		30W	1	3.37	891	
Source Flux		2776lm	2	6.73	223	
Fixture Flux		2776lm	3	10.10	99	
Efficacy		94lm/W	4	13.47	56	
TS843	I _{max} =321cd/klm	I _{max}	891cd	5	16.83	36

Driver	Colour	3000K	4000K
EL.	○	1T4241	1T4243
DALI	○	1T4242	1T4244

Related codes

Canopy

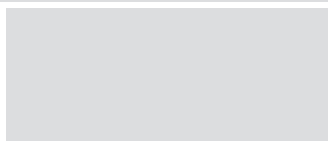

Driver	Colour	Code
EL.	○	1T4071
DALI	○	1T4072

Canopy.

Accessories

Mechanical connector - Rectangular Suspension

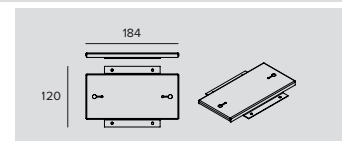

Driver	Code
EL.	1T4075
DALI	1T4240

Linear connector.

Accessories

Control systems



Code
1T5349

Wireless control unit for DALI fixtures.
It generates a local DALI bus that can control individual fixtures.
The module can be connected to an existing DALI network.
The module is wireless controlled using a Casambi app for smartphones and tablets using Bluetooth 4.0 technology.
The devices create a wireless mesh network that can control up to 128 fixtures.
IP20.





Code
1T5352

IP20 Extender for wireless control of DALI fixtures.
It generates a local DALI bus with the capacity to drive up to 64 fixtures.
Can control DALI fixtures in indoor applications.
It is also equipped with a relay that can control non-dimmable fixtures up to a maximum of 6A.

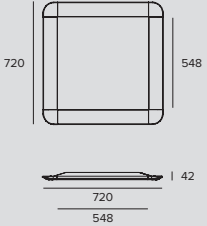

Square Wall/Ceiling UGR<22



LED / 26W / VWFL				±	0.5	IP20
	3000K	H(m)	D(m)			
	Ra80	119°				
	Fixture Power	30W	1	3.37	891	
	Source Flux	2776lm	2	6.73	223	
	Fixture Flux	2776lm	3	10.10	99	
Efficacy	94lm/W	4	13.47	56		
TS843	Imax=321cd/klm	Imax	891cd	5	16.83	36

Driver	Colour	3000K	4000K
EL	○	1T4245	1T4247
DALI	○	1T4246	1T4248

Accessories

Control systems



Code
1T5349

Wireless control unit for DALI fixtures.
It generates a local DALI bus that can control individual fixtures.
The module can be connected to an existing DALI network.
The module is wireless controlled using a Casambi app for smartphones and tablets using Bluetooth 4.0 technology.
The devices create a wireless mesh network that can control up to 128 fixtures.
IP20.



Code
1T5352

IP20 Extender for wireless control of DALI fixtures.
It generates a local DALI bus with the capacity to drive up to 64 fixtures.
Can control DALI fixtures in indoor applications.
It is also equipped with a relay that can control non-dimmable fixtures up to a maximum of 6A.

DIVA

GENERAL INFO

Stand-alone direct or indirect light suspension lamp
1335x435x87mm

LED

Direct lighting LED boards
Indirect lighting LED COB
From 6402lm to 6833lm
3000K – 4000K
Ra84

PRODUCT EFFICACY

Up to 116lm/W

OPTICS

UGR

POWER SUPPLY

Electronic – DALI

MATERIAL

White CRISTALPLANT© body.

A high end suspension light fixture for the office made of Cristalplant without the use of visible screws and joins, with soft lines ideal for the office environment; it interacts with the light using different light emissions: direct, indirect and combined direct/indirect in just one fixture.

Controlled low luminance direct light EN12464, UGR<19 and L65<1500/3000. Micrometric adjustment of the suspension cables using an ABS Auto Block System. Can be adjusted vertically by +/-15°.



01



It is made of Cristalplant®

Technologically advanced and unique composite material that is made up of a high percentage of natural extremely pure polyester polymers and acrylics; it is therefore an inert, hypoallergenic and non-toxic material.

02



Diva hides professional technology:

Suitable for office lighting that meets all the regulations specified in the EN 12464-1 standard in terms of luminance, colour rendering and glare.

03

Diva is able to create three different effects:

Direct emission, indirect emission or mixed direct/indirect emission. The direct component is managed by a textured PMMA screen to control glare while the indirect component is managed by a highly efficient LED COB source that lights the ceiling with a Lambertian 'matte' reflectance to balance the luminance.

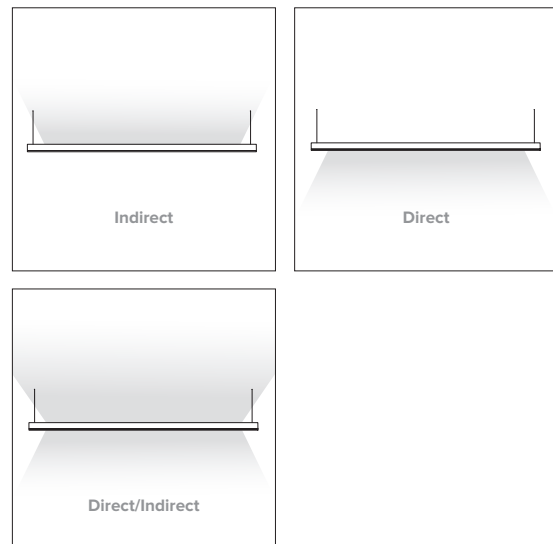

DIVA

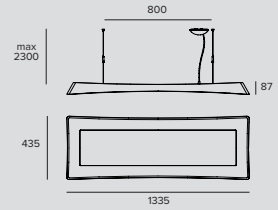
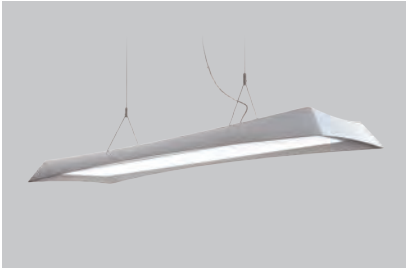

LED / 48W / UGR



		3000K	H(m)	D1(m)	D2(m)	E _{max} (lx)	
		Ra84		88"	92"		
Fixture Power		55W	1	1.95	2.08	1441	
Source Flux		6402lm	2	3.90	4.15	360	
Fixture Flux		6402lm	3	5.84	6.23	160	
Efficacy		116lm/W	4	7.79	8.30	90	
TS803	I _{max} =234cd/klm	I _{max}	1497cd	5	9.74	10.38	58

Driver	Colour	3000K
EL.	○	1T4522
DALI	○	1T4523

LED / 52W / UGR



		4000K	H(m)	D1(m)	D2(m)	E _{max} (lx)	
		Ra84		80"	82"		
Fixture Power		59W	1	1.67	1.75	2068	
Source Flux		6833lm	2	3.34	3.50	517	
Fixture Flux		6833lm	3	5.01	5.25	230	
Efficacy		116lm/W	4	6.67	7.00	129	
TS840	I _{max} =321cd/klm	I _{max}	2190cd	5	8.34	8.75	83

Driver	Colour	4000K
EL.	○	1T4524
DALI	○	1T4525

Accessories

Control systems



Code

1T5352

IP20 Extender for wireless control of DALI fixtures.
 It generates a local DALI bus with the capacity to drive up to 64 fixtures.
 Can control DALI fixtures in indoor applications.
 It is also equipped with a relay that can control non-dimmable fixtures up to a maximum of 6A.



SLIM

Suspension

GENERAL INFO

Indirect or direct/indirect modular suspension for LED sources.

LED

Linear Board LED Low Power High Efficiency
From 2590lm to 13760lm
3000K
Ra84

PRODUCT EFFICACY

Up to 114lm/W

OPTICS

VWFL

POWER SUPPLY

Electronic

MATERIAL

Body made of extruded anodised aluminium.
Polycarbonate lateral end caps. Transparent polycarbonate upper safety screen. Lower diffusive screen made of ribbed, extruded opal polycarbonate.

Minimal modular suspension fixture with indirect or direct/indirect light emission with a compact size to disappear into the environment to leave space for just the architecture and the light.

There is also a linear version that can be configured in a system or stand alone, as well as a rectangular version that is particularly suitable for lighting open spaces.

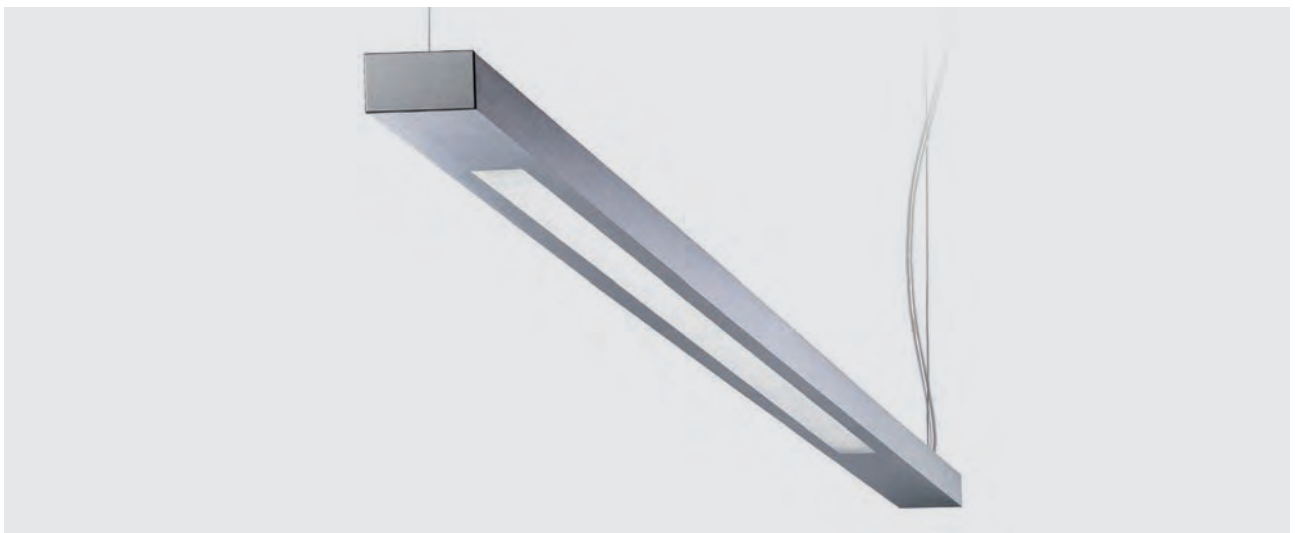



Line L. 1800mm



LED / 18W / INDIRECT / VWFL							
	3000K	H(m)	D(m)	Emax(lx)	Driver	Colour	3000K
	Ra84			115°	EL.		1T4186
	Fixture Power	21W	1	3.13	822		
	Source Flux	2590lm	2	6.26	206		
	Fixture Flux	2353lm	3	9.39	91		
	Efficacy	112lm/W	4	12.52	51		
TS751	Imax=318cd/klm	Imax	824cd	5	15.65	33	



Line L. 3370mm



LED / 36W / INDIRECT / VWFL							
	3000K	H(m)	D(m)	Emax(lx)	Driver	Colour	3000K
	Ra84			115°	EL.		1T4188
	Fixture Power	42W	1	3.13	1645		
	Source Flux	5180lm	2	6.26	411		
	Fixture Flux	4705lm	3	9.39	183		
	Efficacy	112lm/W	4	12.52	103		
TS751	Imax=318cd/klm	Imax	1648cd	5	15.65	66	



Line L. 1800mm



LED / 39W / DIRECT/INDIRECT / VWFL							
	3000K	H(m)	D(m)	Emax(lx)	Driver	Colour	3000K
	Ra84			95°	EL.		1T4187
	Fixture Power	44W	1	2.19	818		
	Source Flux	5620lm	2	4.37	205		
	Fixture Flux	4193lm	3	6.56	91		
	Efficacy	95lm/W	4	8.75	51		
TS752	Imax=147cd/klm	Imax	824cd	5	10.93	33	

SLIM



Line L. 3370mm

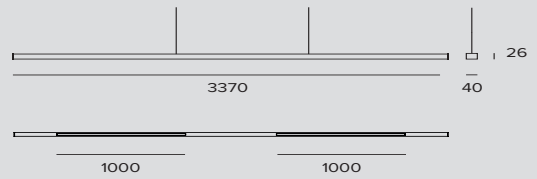

LED / 78W / DIRECT/INDIRECT / VWFL							
	3000K	H(m)	D(m)	Emax(lx)	Driver	Colour	3000K
	Ra84			95°	EL.		1T4189
	Fixture Power	88W	1	2.19	1636		
	Source Flux	11240lm	2	4.37	409		
	Fixture Flux	8386lm	3	6.56	182		
	Efficacy	95lm/W	4	8.75	102		
TS752	Imax=147cd/klm	Imax	1649cd	5	10.93	65	



Rectangle L. 1800mm

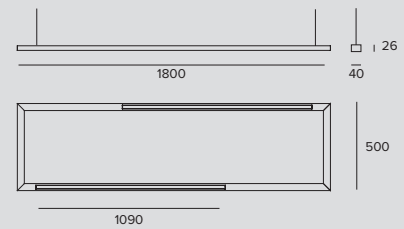

LED / 48W / INDIRECT / VWFL							
	3000K	H(m)	D(m)	Emax(lx)	Driver	Colour	3000K
	Ra84			115°	EL.		1T4190
	Fixture Power	55W	1	3.13	2185		
	Source Flux	6880lm	2	6.26	546		
	Fixture Flux	6249lm	3	9.39	243		
	Efficacy	114lm/W	4	12.52	137		
TS751	Imax=318cd/klm	Imax	2189cd	5	15.65	87	

LED / 96W / DIRECT/INDIRECT / VWFL							
	3000K	H(m)	D(m)	Emax(lx)	Driver	Colour	3000K
	Ra84			95°	EL.		1T4191
	Fixture Power	110W	1	2.19	2003		
	Source Flux	13760lm	2	4.37	501		
	Fixture Flux	10266lm	3	6.56	223		
	Efficacy	93lm/W	4	8.75	125		
TS752	Imax=147cd/klm	Imax	2019cd	5	10.93	80	

Related codes

Power Supply Kit	
Code 1V7213	Code 1V7523
Off-centre circular canopy complete with feeding cable L 2000mm. Maximum power 2kW. For single switching.	Off-centre square canopy complete with feeding cable L 2000mm. Maximum power 2kW. For single switching.

Accessories

Suspension

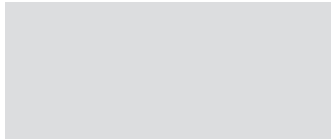

L	Code
10000	1V7264

Steel suspension cable.
Accessory to be ordered only for installations higher than 2000mm.

Cable

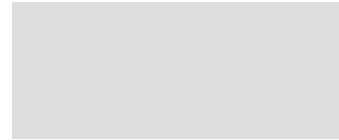

L	Code
5000	1V7262
10000	1V7263

Three pole feeding cable.
Accessory to be ordered only for installations higher than 2000mm.

Mechanical connector

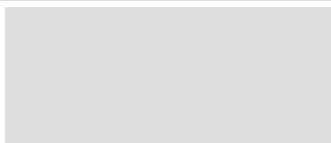

Code
1V7344

Joint for connecting two SLIM Line modules in a straight line. For the codes: 1T4186, 1T4187, 1T4188.

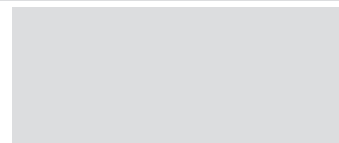

Code
1V7345

Joint for connecting two SLIM Line modules at 90°. For the codes: 1T4186, 1T4187, 1T4188.

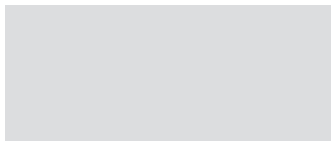

Code
1V7343

Joint for connecting two SLIM Rectangle modules in a line.

Canopy

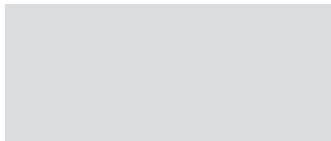

Code
1V7524

Canopy without feeding cable.
Square.

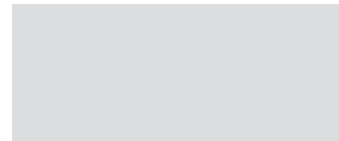

Code
1V7213AB

Canopy without feeding cable.
Circular.

MINIMINIMA

Ceiling Suspension luminaire

GENERAL INFO

Ceiling and suspension luminaire with direct light emission
600x50x32mm

LED

Linear Board LED Low Power High Efficiency 1720lm
3000K

Ra80

Ra90 - To order this version it is necessary to add the suffix "90" at the end of the standard code.

PRODUCT EFFICACY

Up to 62 lm/W

OPTICS

VWFL

POWER SUPPLY

Electronic

MATERIAL

Body made of chromed or painted aluminium with opal polycarbonate diffuser.

A unique, thin linear element designed to remove sharp edges without connecting elements and any visible fastening system.

Available in many types to meet different needs: only indirect or combined direct/indirect light emission.

Available also in a wall mounted version.

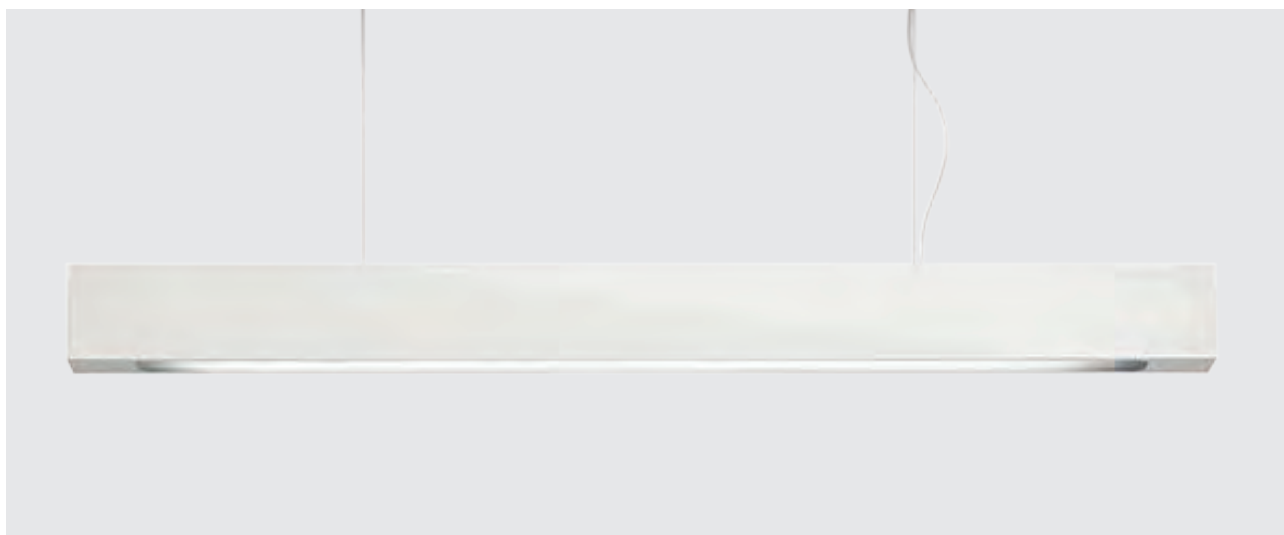



Ceiling

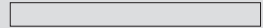

LED / 12W / DIRECT / VWFL



	3000K	H(m)	D(m)	Emax(lx)		
	Ra80		113*			
	Fixture Power	14W	1	3.01	326	
	Source Flux	1720lm	2	6.02	81	
	Fixture Flux	875lm	3	9.02	36	
	Efficacy	62lm/W	4	12.03	20	
TS748	Imax=190cd/klm	Imax	326cd	5	15.04	13

Driver	Colour	3000K
EL.		1T4178
EL.		1T4179
EL.		1T4180
EL.		1T4181

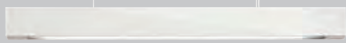

Suspension

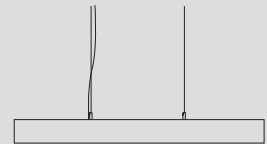

LED / 12W / DIRECT / VWFL



	3000K	H(m)	D(m)	Emax(lx)		
	Ra80		113*			
	Fixture Power	14W	1	3.01	326	
	Source Flux	1720lm	2	6.02	81	
	Fixture Flux	875lm	3	9.02	36	
	Efficacy	62lm/W	4	12.03	20	
TS748	Imax=190cd/klm	Imax	326cd	5	15.04	13

Driver	Colour	3000K
EL.		1T4182
EL.		1T4183
EL.		1T4184
EL.		1T4185

OZ 230V

Stand alone

GENERAL INFO

Fixed multi-optic LED ceiling mounted fixture
Large version: 3x and 5x.
3x: 153x53mm h.100mm
5x: 253x53mm h.100mm

LED

Chip on board
From 1414lm to 3295lm
2700K – 3000K – 3500K – 4000K
Ra90

PRODUCT EFFICACY

Up to 101lm/W

OPTICS

SP – FL - MWFL

POWER SUPPLY

Electronic and DALI driver integrated into the body of the fixture.
Casambi control system available with an accessory (only for DALI version products).

MATERIAL

Black or white painted die-cast aluminium body with black polycarbonate frame.

New ceiling mounted multi-optic fixtures with a new design with miniaturised optics inspired by the OZ 48V version. Only available in the Large version for ceiling installations. Optics SP, FL and MWFL are suitable for installation in work environments - UGR<17 (EN12464-1).

Also available for recessed installation in the Small and Large versions with 1x, 3x or 5x modules.





01
OZ Stand alone



OZ 48V - the same family feeling

The same design, similar performance characteristics with a conceptually different installation philosophy. Small points of light provided by single or multiple elements that are self-sufficient, contrast with the concept of a system which is inspired on the other hand by a continuous line that develops in the space.





Stand Alone Ceiling Luminaire Large 3X (153x53mm)

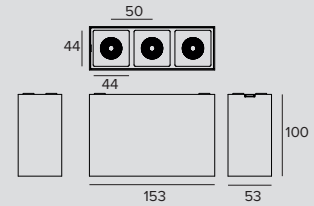

LED / 18W / SP											
	3000K	H(m)	D(m)	Emax(lx)	Driver	Colour	2700K	3000K	3500K	4000K	
	Ra90			19°	EL.	○	1T7890EL	1T7891EL	1T7892EL	1T7893EL	
	Fixture Power	20W	1	0.33	9415	EL.	●	1T7902EL	1T7903EL	1T7904EL	1T7905EL
	Source Flux	1968lm	2	0.66	2354	DALI	○	1T7890DA	1T7891DA	1T7892DA	1T7893DA
	Fixture Flux	1538lm	3	0.99	1046	DALI	●	1T7902DA	1T7903DA	1T7904DA	1T7905DA
	Efficacy	77lm/W	4	1.32	588						
TS1194	Imax=4784cd/klm	Imax	9415cd	5	1.65	377					

LED / 18W / FL											
	3000K	H(m)	D(m)	Emax(lx)	Driver	Colour	2700K	3000K	3500K	4000K	
	Ra90			34°	EL.	○	1T7894EL	1T7895EL	1T7896EL	1T7897EL	
	Fixture Power	20W	1	0.61	5243	EL.	●	1T7906EL	1T7907EL	1T7908EL	1T7909EL
	Source Flux	2517lm	2	1.22	1311	DALI	○	1T7894DA	1T7895DA	1T7896DA	1T7897DA
	Fixture Flux	1797lm	3	1.83	583	DALI	●	1T7906DA	1T7907DA	1T7908DA	1T7909DA
	Efficacy	90lm/W	4	2.43	328						
TS1195	Imax=2083cd/klm	Imax	5243cd	5	3.04	210					

LED / 18W / WFL											
	3000K	H(m)	D(m)	Emax(lx)	Driver	Colour	2700K	3000K	3500K	4000K	
	Ra90			50°	EL.	○	1T7898EL	1T7899EL	1T7900EL	1T7901EL	
	Fixture Power	20W	1	0.93	3157	EL.	●	1T7910EL	1T7911EL	1T7912EL	1T7913EL
	Source Flux	2517lm	2	1.85	789	DALI	○	1T7898DA	1T7899DA	1T7900DA	1T7901DA
	Fixture Flux	1947lm	3	2.78	351	DALI	●	1T7910DA	1T7911DA	1T7912DA	1T7913DA
	Efficacy	97lm/W	4	3.71	197						
TS1196	Imax=1254cd/klm	Imax	3157cd	5	4.64	126					



Stand Alone Ceiling Luminaire Large 5X (253x53mm)

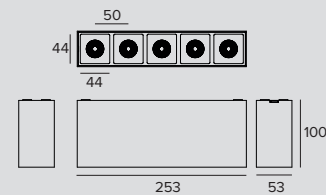

LED / 30W / SP											
	3000K	H(m)	D(m)	Emax(lx)	Driver	Colour	2700K	3000K	3500K	4000K	
	Ra90			19°	EL.	○	1T7914EL	1T7915EL	1T7916EL	1T7917EL	
	Fixture Power	34W	1	0.33	15692	EL.	●	1T7926EL	1T7927EL	1T7928EL	1T7929EL
	Source Flux	3280lm	2	0.66	3923	DALI	○	1T7914DA	1T7915DA	1T7916DA	1T7917DA
	Fixture Flux	2563lm	3	0.99	1744	DALI	●	1T7926DA	1T7927DA	1T7928DA	1T7929DA
	Efficacy	75lm/W	4	1.32	981						
TS1194	Imax=4784cd/klm	Imax	15692cd	5	1.65	628					

LED / 30W / FL ⊕ 1 IP20

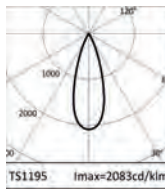

	3000K	H(m)	D(m)	E _{max} (lx)		
Ra90			34°			
Fixture Power	34W	1	0.61	8739		
Source Flux	4195lm	2	1.22	2185		
Fixture Flux	2996lm	3	1.83	971		
Efficacy	88lm/W	4	2.43	546		
TS1195	I _{max} =2083cd/klm	I _{max}	8739cd	5	3.04	350

Driver	Colour	2700K	3000K	3500K	4000K
EL.	○	1T7918EL	1T7919EL	1T7920EL	1T7921EL
EL.	●	1T7930EL	1T7931EL	1T7932EL	1T7933EL
DALI	○	1T7918DA	1T7919DA	1T7920DA	1T7921DA
DALI	●	1T7930DA	1T7931DA	1T7932DA	1T7933DA

LED / 30W / WFL ⊕ 1 IP20

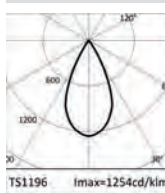

	3000K	H(m)	D(m)	E _{max} (lx)		
Ra90			50°			
Fixture Power	34W	1	0.93	5262		
Source Flux	4195lm	2	1.85	1315		
Fixture Flux	3246lm	3	2.78	585		
Efficacy	95lm/W	4	3.71	329		
TS1196	I _{max} =1254cd/klm	I _{max}	5262cd	5	4.64	210

Driver	Colour	2700K	3000K	3500K	4000K
EL.	○	1T7922EL	1T7923EL	1T7924EL	1T7925EL
EL.	●	1T7934EL	1T7935EL	1T7936EL	1T7937EL
DALI	○	1T7922DA	1T7923DA	1T7924DA	1T7925DA
DALI	●	1T7934DA	1T7935DA	1T7936DA	1T7937DA

Accessories

Control systems

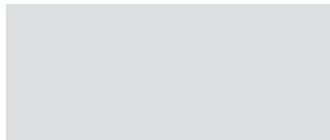

Code

1T5349

Wireless control unit for DALI fixtures.
It generates a local DALI bus that can control individual fixtures.
The module can be connected to an existing DALI network.
The module is wireless controlled using a Casambi app for smartphones and tablets using Bluetooth 4.0 technology.
The devices create a wireless mesh network that can control up to 128 fixtures.
IP20.

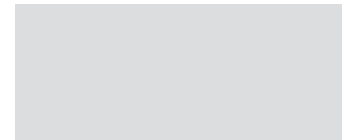

Code

1T5352

IP20 Extender for wireless control of DALI fixtures.
It generates a local DALI bus with the capacity to drive up to 64 fixtures.
Can control DALI fixtures in indoor applications.
It is also equipped with a relay that can control non-dimmable fixtures up to a maximum of 6A.



THREESIXTY

GENERAL INFO

Circular LED fixture for ceiling mounted, suspension and wall mounted installations.

Ø384mm - Ø590mm - Ø870mm - Ø1150mm

LED

Self-cooling circular boards.

From 2017lm to 44809lm

3000K – 4000K

Ra84

Ra90 - To order this version it is necessary to add the suffix "90" at the end of the standard code.

PRODUCT EFFICACY

Up to 117lm/W

OPTICS

OPAL – UGR – OPAL+HALO – UGR+HALO

POWER SUPPLY

Electronic – DALI

Casambi control: the DALI version is fitted with special accessories.

MATERIAL

Powder coated, extruded, calendered aluminium.

A fixture with a pure and simple design in four different diameters and five different installation types : recessed, semi-recessed, ceiling mounted, suspension and wall mounted. Any light fixture can be configured in various ways when accessorised with different installation elements.

Available only with direct, direct/indirect light or in a direct light version combined with a slight indirect HALO component. a solution that is particularly suitable for the ceiling mounted, wall mounted or semi-recessed versions to create a soft frame of light. Also available in UGR<19 for the two smaller diameters.





Théâtre De Gennevilliers

Country
Gennevilliers - France

01

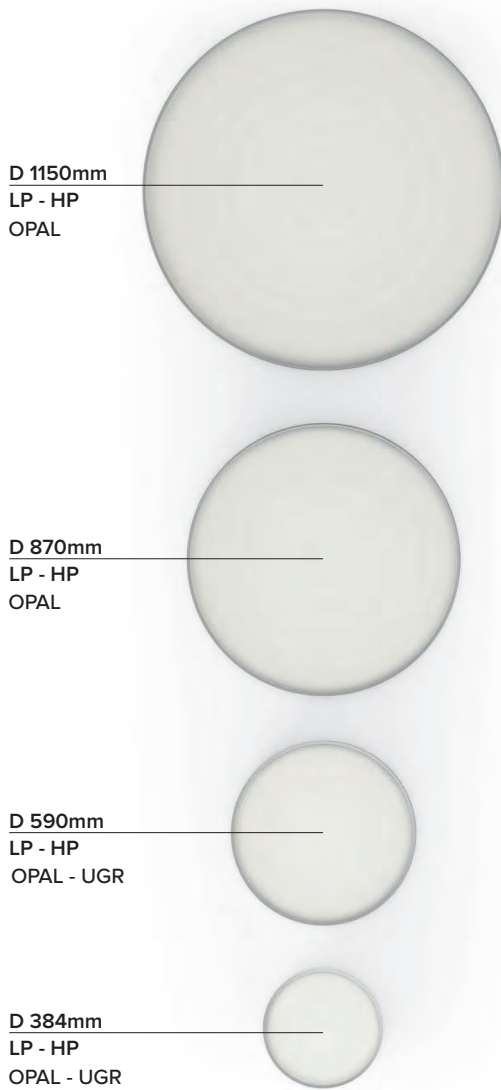

Four different diameters

To light spaces with different characteristics. Compact solutions to light environments with limited heights and large size fixtures to light great heights and showrooms.

02



A wide range of direct or direct/indirect lighting effects

Diffused light, controlled light UGR<19 and a particular Halo effect

Recessed - Semi recessed

Frame

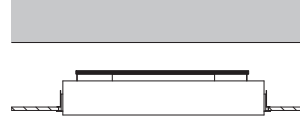

Adjustable frame

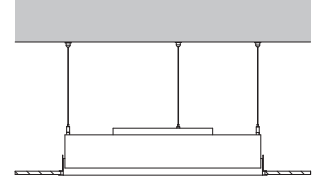

Wall and ceiling mounted

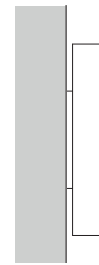
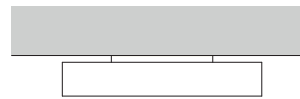

Suspension

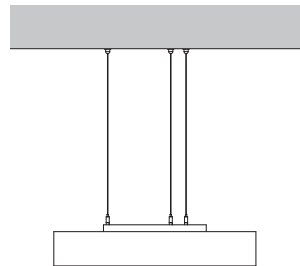

Different lumen packages

For every diameter to light spaces with the same design.

One single body for five different installation solutions.

The fixture can be ceiling or wall mounted without the use of any accessories. For suspension installation a special suspension kit must be used.

For recessed or semi-recessed installations it must be completed with special outer casings.

The 384 mm and 590 mm versions are compatible with an accessory standard or HALO version load bearing outer frame that attaches directly to the false ceiling.

The 384 mm, 590 mm, 870 mm and 1150 mm versions are compatible with a recessed non load bearing frame that attaches to the main ceiling.

THREESIXTY



Ø 384mm

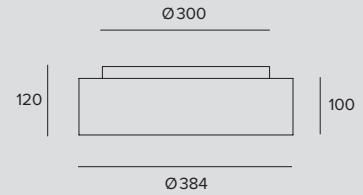

LED / 21W / DOWN OPAL

		3000K	H(m)	D(m)	Emax(lx)	
Ra84					114*	
Fixture Power	24W	1	3.09	636		
Source Flux	3033lm	2	6.17	159		
Fixture Flux	1836lm	3	9.26	71		
Efficacy	76lm/W	4	12.35	40		
TS1002	Imax=210cd/klm	Imax	636cd	5	15.43	25

Driver	Colour	3000K	4000K
EL.	○	1T6066EL	1T6067EL
EL.	●	1T6070EL	1T6071EL
EL.	●	1T6068EL	1T6069EL
DALI	○	1T6066DA	1T6067DA
DALI	●	1T6070DA	1T6071DA
DALI	●	1T6068DA	1T6069DA

LED / 29W / DOWN OPAL

		3000K	H(m)	D(m)	Emax(lx)	
Ra84					114*	
Fixture Power	33W	1	3.09	848		
Source Flux	4044lm	2	6.17	212		
Fixture Flux	2448lm	3	9.26	94		
Efficacy	74lm/W	4	12.35	53		
TS1003	Imax=210cd/klm	Imax	848cd	5	15.43	34

Driver	Colour	3000K	4000K
EL.	○	1T6072EL	1T6073EL
EL.	●	1T6076EL	1T6077EL
EL.	●	1T6074EL	1T6075EL
DALI	○	1T6072DA	1T6073DA
DALI	●	1T6076DA	1T6077DA
DALI	●	1T6074DA	1T6075DA

LED / 13W / DOWN UGR

		3000K	H(m)	D(m)	Emax(lx)	
Ra84					92*	
Fixture Power	15W	1	2.07	702		
Source Flux	2017lm	2	4.15	176		
Fixture Flux	1458lm	3	6.22	78		
Efficacy	97lm/W	4	8.29	44		
TS1018	Imax=348cd/klm	Imax	702cd	5	10.36	28

Driver	Colour	3000K	4000K
EL.	○	1T6102EL	1T6103EL
EL.	●	1T6106EL	1T6107EL
EL.	●	1T6104EL	1T6105EL
DALI	○	1T6102DA	1T6103DA
DALI	●	1T6106DA	1T6107DA
DALI	●	1T6104DA	1T6105DA

LED / 29W / UP-DOWN OPAL

		3000K	H(m)	D(m)	Emax(lx)	
Ra84					114*	
Fixture Power	33W	1	3.09	636		
Source Flux	4475lm	2	6.17	159		
Fixture Flux	3142lm	3	9.26	71		
Efficacy	95lm/W	4	12.35	40		
TS1004	Imax=142cd/klm	Imax	636cd	5	15.43	25

Driver	Colour	3000K	4000K
EL.	○	1T6090EL	1T6091EL
EL.	●	1T6094EL	1T6095EL
EL.	●	1T6092EL	1T6093EL
DALI	○	1T6090DA	1T6091DA
DALI	●	1T6094DA	1T6095DA
DALI	●	1T6092DA	1T6093DA

LED / 37W / UP-DOWN OPAL

		3000K	H(m)	D(m)	Emax(lx)	
Ra84					114*	
Fixture Power	42W	1	3.09	848		
Source Flux	5486lm	2	6.17	212		
Fixture Flux	3754lm	3	9.26	94		
Efficacy	89lm/W	4	12.35	53		
TS1014	Imax=155cd/klm	Imax	848cd	5	15.43	34

Driver	Colour	3000K	4000K
EL.	○	1T6096EL	1T6097EL
EL.	●	1T6100EL	1T6101EL
EL.	●	1T6098EL	1T6099EL
DALI	○	1T6096DA	1T6097DA
DALI	●	1T6100DA	1T6101DA
DALI	●	1T6098DA	1T6099DA

LED / 21W / UP-DOWN UGR

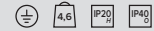

	3000K	H(m)	D(m)	Emax(lx)		
	Ra84		92°			
	Fixture Power	24W	1	2.07	711	
	Source Flux	3484lm	2	4.15	178	
	Fixture Flux	2783lm	3	6.22	79	
	Efficacy	116lm/W	4	8.29	44	
TS1021	Imax=204cd/klm	Imax	711cd	5	10.36	28

Driver	Colour	3000K	4000K
EL.	○	1T6126EL	1T6127EL
EL.	●	1T6130EL	1T6131EL
EL.	◐	1T6128EL	1T6129EL
DALI	○	1T6126DA	1T6127DA
DALI	●	1T6130DA	1T6131DA
DALI	◐	1T6128DA	1T6129DA

LED / 35W (40,5W fixture power) / OPAL + HALO



	3000K	H(m)	D(m)	Emax(lx)		
	Ra84		114°			
	Fixture Power	24W	1	3.09	636	
	Source Flux	3033lm	2	6.17	159	
	Fixture Flux	1836lm	3	9.26	71	
	Efficacy	76lm/W	4	12.35	40	
TS1002	Imax=210cd/klm	Imax	636cd	5	15.43	25

Driver	Colour	3000K	4000K
EL.	○	1T6078EL	1T6079EL
EL.	●	1T6082EL	1T6083EL
EL.	◐	1T6080EL	1T6081EL
DALI	○	1T6078DA	1T6079DA
DALI	●	1T6082DA	1T6083DA
DALI	◐	1T6080DA	1T6081DA

LED / 43W (49,5W fixture power) / OPAL + HALO

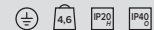

	3000K	H(m)	D(m)	Emax(lx)		
	Ra84		114°			
	Fixture Power	33W	1	3.09	848	
	Source Flux	4044lm	2	6.17	212	
	Fixture Flux	2448lm	3	9.26	94	
	Efficacy	74lm/W	4	12.35	53	
TS1003	Imax=210cd/klm	Imax	848cd	5	15.43	34

Driver	Colour	3000K	4000K
EL.	○	1T6084EL	1T6085EL
EL.	●	1T6088EL	1T6089EL
EL.	◐	1T6086EL	1T6087EL
DALI	○	1T6084DA	1T6085DA
DALI	●	1T6088DA	1T6089DA
DALI	◐	1T6086DA	1T6087DA

LED / 27W (31,5W fixture power) / UGR + HALO

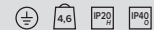

	3000K	H(m)	D(m)	Emax(lx)		
	Ra84		92°			
	Fixture Power	15W	1	2.07	702	
	Source Flux	2017lm	2	4.15	176	
	Fixture Flux	1458lm	3	6.22	78	
	Efficacy	97lm/W	4	8.29	44	
TS1018	Imax=348cd/klm	Imax	702cd	5	10.36	28

Driver	Colour	3000K	4000K
EL.	○	1T6114EL	1T6115EL
EL.	●	1T6118EL	1T6119EL
EL.	◐	1T6116EL	1T6117EL
DALI	○	1T6114DA	1T6115DA
DALI	●	1T6118DA	1T6119DA
DALI	◐	1T6116DA	1T6117DA



Ø 590mm

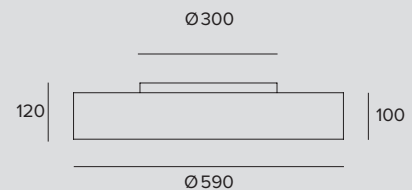

LED / 50W / DOWN OPAL

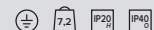

	3000K	H(m)	D(m)	Emax(lx)		
	Ra84		114°			
	Fixture Power	57W	1	3.09	1555	
	Source Flux	7418lm	2	6.17	389	
	Fixture Flux	4490lm	3	9.26	173	
	Efficacy	79lm/W	4	12.35	97	
TS1002	Imax=210cd/klm	Imax	1555cd	5	15.43	62

Driver	Colour	3000K	4000K
EL.	○	1T6138EL	1T6139EL
EL.	●	1T6142EL	1T6143EL
EL.	◐	1T6140EL	1T6141EL
DALI	○	1T6138DA	1T6139DA
DALI	●	1T6142DA	1T6143DA
DALI	◐	1T6140DA	1T6141DA

THREESIXTY

LED / 67W / DOWN OPAL



		3000K	H(m)	D(m)	Emax(lx)	
Ra84				114°		
Fixture Power	75W	1	3.09	2079		
Source Flux	9917lm	2	6.17	520		
Fixture Flux	6003lm	3	9.26	231		
Efficacy	80lm/W	4	12.35	130		
TS1003	Imax=210cd/klm	Imax	2079cd	5	15.43	83

Driver	Colour	3000K	4000K
EL.	○	1T6144EL	1T6145EL
EL.	●	1T6148EL	1T6149EL
EL.	●	1T6146EL	1T6147EL
DALI	○	1T6144DA	1T6145DA
DALI	●	1T6148DA	1T6149DA
DALI	●	1T6146DA	1T6147DA

LED / 31W / DOWN UGR

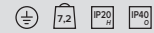

		3000K	H(m)	D(m)	Emax(lx)	
Ra84				92°		
Fixture Power	35W	1	2.07	1722		
Source Flux	4944lm	2	4.15	430		
Fixture Flux	3575lm	3	6.22	191		
Efficacy	102lm/W	4	8.29	108		
TS1019	Imax=348cd/klm	Imax	1722cd	5	10.36	69

Driver	Colour	3000K	4000K
EL.	○	1T6174EL	1T6175EL
EL.	●	1T6178EL	1T6179EL
EL.	●	1T6176EL	1T6177EL
DALI	○	1T6174DA	1T6175DA
DALI	●	1T6178DA	1T6179DA
DALI	●	1T6176DA	1T6177DA

LED / 67W / UP-DOWN OPAL



		3000K	H(m)	D(m)	Emax(lx)	
Ra84				114°		
Fixture Power	76W	1	3.09	1555		
Source Flux	10112lm	2	6.17	389		
Fixture Flux	6932lm	3	9.26	173		
Efficacy	91lm/W	4	12.35	97		
TS1005	Imax=154cd/klm	Imax	1555cd	5	15.43	62

Driver	Colour	3000K	4000K
EL.	○	1T6162EL	1T6163EL
EL.	●	1T6166EL	1T6167EL
EL.	●	1T6164EL	1T6165EL
DALI	○	1T6162DA	1T6163DA
DALI	●	1T6166DA	1T6167DA
DALI	●	1T6164DA	1T6165DA

LED / 84W / UP-DOWN OPAL

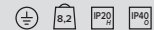

		3000K	H(m)	D(m)	Emax(lx)	
Ra84				114°		
Fixture Power	94W	1	3.09	2080		
Source Flux	12611lm	2	6.17	520		
Fixture Flux	8445lm	3	9.26	231		
Efficacy	90lm/W	4	12.35	130		
TS1015	Imax=165cd/klm	Imax	2080cd	5	15.43	83

Driver	Colour	3000K	4000K
EL.	○	1T6168EL	1T6169EL
EL.	●	1T6172EL	1T6173EL
EL.	●	1T6170EL	1T6171EL
DALI	○	1T6168DA	1T6169DA
DALI	●	1T6172DA	1T6173DA
DALI	●	1T6170DA	1T6171DA

LED / 48W / UP-DOWN UGR



		3000K	H(m)	D(m)	Emax(lx)	
Ra84				92°		
Fixture Power	54W	1	2.07	1740		
Source Flux	7692lm	2	4.15	435		
Fixture Flux	6055lm	3	6.22	193		
Efficacy	112lm/W	4	8.29	109		
TS1020	Imax=226cd/klm	Imax	1740cd	5	10.36	70

Driver	Colour	3000K	4000K
EL.	○	1T6198EL	1T6199EL
EL.	●	1T6202EL	1T6203EL
EL.	●	1T6200EL	1T6201EL
DALI	○	1T6198DA	1T6199DA
DALI	●	1T6202DA	1T6203DA
DALI	●	1T6200DA	1T6201DA

LED / 70W (81W fixture power) / OPAL + HALO

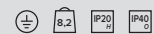

		3000K	H(m)	D(m)	Emax(lx)	
Ra84				114°		
Fixture Power	57W	1	3.09	1555		
Source Flux	7418lm	2	6.17	389		
Fixture Flux	4490lm	3	9.26	173		
Efficacy	79lm/W	4	12.35	97		
TS1002	Imax=210cd/klm	Imax	1555cd	5	15.43	62

Driver	Colour	3000K	4000K
EL.	○	1T6150EL	1T6151EL
EL.	●	1T6154EL	1T6155EL
EL.	●	1T6152EL	1T6153EL
DALI	○	1T6150DA	1T6151DA
DALI	●	1T6154DA	1T6155DA
DALI	●	1T6152DA	1T6153DA

LED / 87W (99W fixture power) / OPAL + HALO										
	3000K	H(m)	D(m)	E _{max} (lx)	Driver	Colour	3000K	4000K		
	Ra84			114*	EL.	○	1T6156EL	1T6157EL		
	Fixture Power	75W	1	3.09	2079	EL.	●	1T6160EL	1T6161EL	
	Source Flux	9917lm	2	6.17	520	EL.	●	1T6158EL	1T6159EL	
	Fixture Flux	6003lm	3	9.26	231	DALI	○	1T6156DA	1T6157DA	
	Efficacy	80lm/W	4	12.35	130	DALI	●	1T6160DA	1T6161DA	
TS1003	Imax=210cd/klm	Imax	2079cd	5	15.43	83	DALI	●	1T6158DA	1T6159DA

LED / 51W (59W fixture power) / UGR + HALO										
	3000K	H(m)	D(m)	E _{max} (lx)	Driver	Colour	3000K	4000K		
	Ra84			92*	EL.	○	1T6186EL	1T6187EL		
	Fixture Power	35W	1	2.07	1722	EL.	●	1T6190EL	1T6191EL	
	Source Flux	4944lm	2	4.15	430	EL.	●	1T6188EL	1T6189EL	
	Fixture Flux	3575lm	3	6.22	191	DALI	○	1T6186DA	1T6187DA	
	Efficacy	102lm/W	4	8.29	108	DALI	●	1T6190DA	1T6191DA	
TS1019	Imax=348cd/klm	Imax	1722cd	5	10.36	69	DALI	●	1T6188DA	1T6189DA

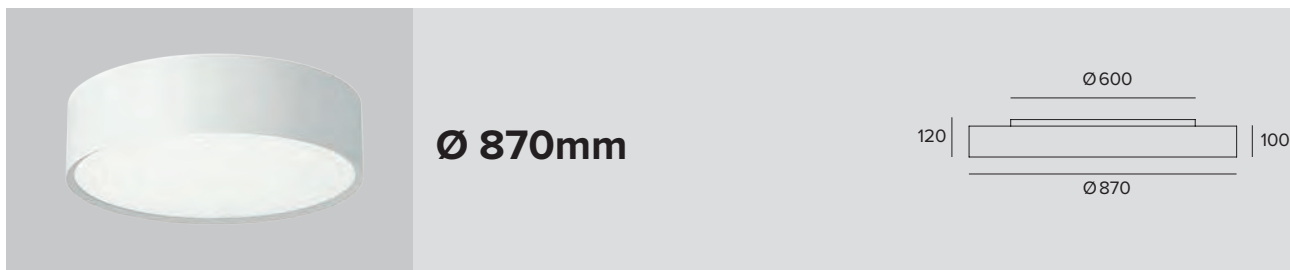

LED / 113W / DOWN OPAL										
	3000K	H(m)	D(m)	E _{max} (lx)	Driver	Colour	3000K	4000K		
	Ra84			114*	EL.	○	1T6210EL	1T6211EL		
	Fixture Power	127W	1	3.09	3404	EL.	●	1T6214EL	1T6215EL	
	Source Flux	16238lm	2	6.17	851	EL.	●	1T6212EL	1T6213EL	
	Fixture Flux	9829lm	3	9.26	378	DALI	○	1T6210DA	1T6211DA	
	Efficacy	77lm/W	4	12.35	213	DALI	●	1T6214DA	1T6215DA	
TS1002	Imax=210cd/klm	Imax	3404cd	5	15.43	136	DALI	●	1T6212DA	1T6213DA

LED / 144W / DOWN OPAL										
	3000K	H(m)	D(m)	E _{max} (lx)	Driver	Colour	3000K	4000K		
	Ra84			114*	EL.	○	1T6216EL	1T6217EL		
	Fixture Power	162W	1	3.09	4548	EL.	●	1T6220EL	1T6221EL	
	Source Flux	21693lm	2	6.17	1137	EL.	●	1T6218EL	1T6219EL	
	Fixture Flux	13131lm	3	9.26	505	DALI	○	1T6216DA	1T6217DA	
	Efficacy	81lm/W	4	12.35	284	DALI	●	1T6220DA	1T6221DA	
TS1003	Imax=210cd/klm	Imax	4548cd	5	15.43	182	DALI	●	1T6218DA	1T6219DA

Note

HALO Version: for the photometric curve please see the direct version. Indirect emission with the HALO effect is purely decorative and its effect depends on the type of installation.

DIRECT/INDIRECT VERSION: Fitted with separate switches. Three different light effects available: direct light, indirect light and mixed direct/indirect light.

Check mounting instructions to verify the quantity of DALI drivers installed.

THREESIXTY

LED / 146W / UP-DOWN OPAL



		3000K	H(m)	D(m)	E _{max} (lx)
Ra84		114°			
Fixture Power	164W	1	3.09	3406	
Source Flux	20629lm	2	6.17	852	
Fixture Flux	13813lm	3	9.26	378	
Efficacy	84lm/W	4	12.35	213	
TS1006	I _{max} =165cd/klm	I _{max}	3406cd	5	15.43
					136

Driver	Colour	3000K	4000K
EL.	○	1T6234EL	1T6235EL
EL.	●	1T6238EL	1T6239EL
EL.	●	1T6236EL	1T6237EL
DALI	○	1T6234DA	1T6235DA
DALI	●	1T6238DA	1T6239DA
DALI	●	1T6236DA	1T6237DA

LED / 177W / UP-DOWN OPAL



		3000K	H(m)	D(m)	E _{max} (lx)
Ra84		114°			
Fixture Power	199W	1	3.09	4548	
Source Flux	26084lm	2	6.17	1137	
Fixture Flux	17111lm	3	9.26	505	
Efficacy	86lm/W	4	12.35	284	
TS1016	I _{max} =174cd/klm	I _{max}	4548cd	5	15.43
					182

Driver	Colour	3000K	4000K
EL.	○	1T6240EL	1T6241EL
EL.	●	1T6244EL	1T6245EL
EL.	●	1T6242EL	1T6243EL
DALI	○	1T6240DA	1T6241DA
DALI	●	1T6244DA	1T6245DA
DALI	●	1T6242DA	1T6243DA

LED / 138W (160W fixture power) / OPAL + HALO



		3000K	H(m)	D(m)	E _{max} (lx)
Ra84		114°			
Fixture Power	127W	1	3.09	3404	
Source Flux	16238lm	2	6.17	851	
Fixture Flux	9829lm	3	9.26	378	
Efficacy	77lm/W	4	12.35	213	
TS1002	I _{max} =210cd/klm	I _{max}	3404cd	5	15.43
					136

Driver	Colour	3000K	4000K
EL.	○	1T6222EL	1T6223EL
EL.	●	1T6226EL	1T6227EL
EL.	●	1T6224EL	1T6225EL
DALI	○	1T6222DA	1T6223DA
DALI	●	1T6226DA	1T6227DA
DALI	●	1T6224DA	1T6225DA

LED / 174W (201W fixture power) / OPAL + HALO



		3000K	H(m)	D(m)	E _{max} (lx)
Ra84		114°			
Fixture Power	162W	1	3.09	4548	
Source Flux	21693lm	2	6.17	1137	
Fixture Flux	13131lm	3	9.26	505	
Efficacy	81lm/W	4	12.35	284	
TS1003	I _{max} =210cd/klm	I _{max}	4548cd	5	15.43
					182

Driver	Colour	3000K	4000K
EL.	○	1T6228EL	1T6229EL
EL.	●	1T6232EL	1T6233EL
EL.	●	1T6230EL	1T6231EL
DALI	○	1T6228DA	1T6229DA
DALI	●	1T6232DA	1T6233DA
DALI	●	1T6230DA	1T6231DA



Ø 1150mm

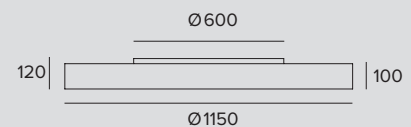

LED / 182W / DOWN OPAL

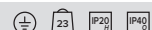

		3000K	H(m)	D(m)	E _{max} (lx)
Ra84		114°			
Fixture Power	204W	1	3.09	5760	
Source Flux	27475lm	2	6.17	1440	
Fixture Flux	16631lm	3	9.26	640	
Efficacy	82lm/W	4	12.35	360	
TS1002	I _{max} =210cd/klm	I _{max}	5760cd	5	15.43
					230

Driver	Colour	3000K	4000K
EL.	○	1T6246EL	1T6247EL
EL.	●	1T6250EL	1T6251EL
EL.	●	1T6248EL	1T6249EL
DALI	○	1T6246DA	1T6247DA
DALI	●	1T6250DA	1T6251DA
DALI	●	1T6248DA	1T6249DA

LED / 243W / DOWN OPAL



	3000K	H(m)	D(m)	E _{max} (lx)
Ra84			114*	
Fixture Power	273W	1	3.09	7695
Source Flux	36705lm	2	6.17	1924
Fixture Flux	22218lm	3	9.26	855
Efficacy	81lm/W	4	12.35	481
TS1003	Imax=210cd/klm	Imax	7695cd	5 15.43 308

Driver	Colour	3000K	4000K
EL.	○	1T6252EL	1T6253EL
EL.	●	1T6256EL	1T6257EL
EL.	◐	1T6254EL	1T6255EL
DALI	○	1T6252DA	1T6253DA
DALI	●	1T6256DA	1T6257DA
DALI	◐	1T6254DA	1T6255DA

LED / 233W / UP-DOWN OPAL



	3000K	H(m)	D(m)	E _{max} (lx)
Ra84			114*	
Fixture Power	261W	1	3.09	5761
Source Flux	33649lm	2	6.17	1440
Fixture Flux	22227lm	3	9.26	640
Efficacy	85lm/W	4	12.35	360
TS1007	Imax=171cd/klm	Imax	5761cd	5 15.43 230

Driver	Colour	3000K	4000K
EL.	○	1T6270EL	1T6271EL
EL.	●	1T6274EL	1T6275EL
EL.	◐	1T6272EL	1T6273EL
DALI	○	1T6270DA	1T6271DA
DALI	●	1T6274DA	1T6275DA
DALI	◐	1T6272DA	1T6273DA

LED / 294W / UP-DOWN OPAL



	3000K	H(m)	D(m)	E _{max} (lx)
Ra84			114*	
Fixture Power	330W	1	3.09	7696
Source Flux	42879lm	2	6.17	1924
Fixture Flux	27815lm	3	9.26	855
Efficacy	84lm/W	4	12.35	481
TS1017	Imax=179cd/klm	Imax	7696cd	5 15.43 308

Driver	Colour	3000K	4000K
EL.	○	1T6276EL	1T6277EL
EL.	●	1T6280EL	1T6281EL
EL.	◐	1T6278EL	1T6279EL
DALI	○	1T6276DA	1T6277DA
DALI	●	1T6280DA	1T6281DA
DALI	◐	1T6278DA	1T6279DA

LED / 226W (258W fixture power) / OPAL + HALO

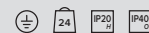

	3000K	H(m)	D(m)	E _{max} (lx)
Ra84			114*	
Fixture Power	204W	1	3.09	5760
Source Flux	27475lm	2	6.17	1440
Fixture Flux	16631lm	3	9.26	640
Efficacy	82lm/W	4	12.35	360
TS1002	Imax=210cd/klm	Imax	5760cd	5 15.43 230

Driver	Colour	3000K	4000K
EL.	○	1T6258EL	1T6259EL
EL.	●	1T6262EL	1T6263EL
EL.	◐	1T6260EL	1T6261EL
DALI	○	1T6258DA	1T6259DA
DALI	●	1T6262DA	1T6263DA
DALI	◐	1T6260DA	1T6261DA

LED / 286W (325W fixture power) / OPAL + HALO



	3000K	H(m)	D(m)	E _{max} (lx)
Ra84			114*	
Fixture Power	273W	1	3.09	7695
Source Flux	36705lm	2	6.17	1924
Fixture Flux	22218lm	3	9.26	855
Efficacy	81lm/W	4	12.35	481
TS1003	Imax=210cd/klm	Imax	7695cd	5 15.43 308

Driver	Colour	3000K	4000K
EL.	○	1T6264EL	1T6265EL
EL.	●	1T6268EL	1T6269EL
EL.	◐	1T6266EL	1T6267EL
DALI	○	1T6264DA	1T6265DA
DALI	●	1T6268DA	1T6269DA
DALI	◐	1T6266DA	1T6267DA

Note



HALO Version: for the photometric curve please see the direct version. Indirect emission with the HALO effect is purely decorative and its effect depends on the type of installation.

DIRECT/INDIRECT VERSION: Fitted with separate switches. Three different light effects available: direct light, indirect light and mixed direct/indirect light.







Check mounting instructions to verify the quantity of DALI drivers installed.

THREESIXTY

Related codes

Suspension			
			
	L	Colour	Code
	2000		1T6282
	4000		1T6285

Suspension kit composed of 3 steel cables with an ABS control system.
Suspension kit compatible with ceiling or wall installations, even inclined.

Power Supply Kit			
			
	Driver	Colour	Code
	EL.		1T6288EL
	EL.		1T6289EL
	EL.		1T6290EL
	DALI		1T6288DA
	DALI		1T6289DA
	DALI		1T6290DA

Accessory for suspension installation composed of a canopy and 3 or 5 poles complete with a 4000mm power cable.

Accessories

Control systems	
	
	Code
	1T5349

Wireless control unit for DALI fixtures.
It generates a local DALI bus that can control individual fixtures.
The module can be connected to an existing DALI network.
The module is wireless controlled using a Casambi app for smartphones and tablets using Bluetooth 4.0 technology.
The devices create a wireless mesh network that can control up to 128 fixtures.
IP20.

	
	Code
	1T5352

IP20 Extender for wireless control of DALI fixtures.
It generates a local DALI bus with the capacity to drive up to 64 fixtures.
Can control DALI fixtures in indoor applications.
It is also equipped with a relay that can control non-dimmable fixtures up to a maximum of 6A.



PANTHEON

GENERAL INFO

Direct or diffused LED light pendant fixture.
Ceiling only for Ø700 version
Ø400mm – Ø600mm – Ø700mm

LED

LED 230V module
From 708lm to 1865lm
3000K
Ra84

PRODUCT EFFICACY

Up to 93 lm/W

OPTICS

WFL for Pantheon Ø400
VWFL for Pantheon Ø600 and Ø700

POWER SUPPLY

No driver necessary
Casambi control system available by using a dedicated accessory (230Vac LED module max 150W).

MATERIAL

PANTHEON 400
Painted spun aluminium body. Integrated heat dissipator in die-cast aluminium.

PANTHEON 600 AND 700

Body in matt white shockproof PE obtained from rotational moulding. UV protection. 100% recyclable and solution-dyed. Integrated heat dissipator in die-cast aluminium.

This smooth and seemingly weightless suspension fixture combines high impact pure design with efficiency and a quality lighting effect.

It is available in three different sizes and two different materials. There is a small aluminium version, and a medium and large version in 100% recyclable, lightweight polyethylene. PANTHEON 600 and 700 are available with a translucent lens cap for a diffused emission or an opaque lens cap for direct light only.





Zonamerica

Architect
Estudio Dovat
Arquitectos

Lighting Design
Estudio Hofstadter

Photographer
Ferrés - Cánepa

Country
Montevideo,
Uruguay

PANTHEON



Ø 700mm

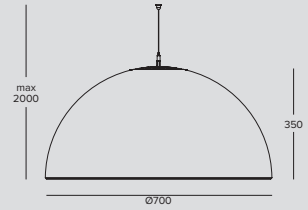

LED / 20W / DIRECT / VWFL					⊕	5.2	IP20
	3000K	H(m)	D(m)	E _{max} (lx)	Power supply	Colour	3000K
	Ra80		71°		220-240Vac	○	1T4049
	Fixture Power	20W	1	1.43	1135		
	Source Flux	1865lm	2	2.87	284		
	Fixture Flux	1847lm	3	4.30	126		
	Efficacy	92lm/W	4	5.74	71		
TS806	I _{max} =608cd/klm	I _{max}	1135cd	5	7.17	45	

LED / 20W / DIFFUSE / WFL					⊕	5.2	IP20
	3000K	H(m)	D(m)	E _{max} (lx)	Power supply	Colour	3000K
	Ra80		68°		220-240Vac	○	1T4050
	Fixture Power	20W	1	1.36	1101		
	Source Flux	1865lm	2	2.72	275		
	Fixture Flux	1865lm	3	4.08	122		
	Efficacy	93lm/W	4	5.43	69		
TS805	I _{max} =590cd/klm	I _{max}	1101cd	5	6.79	44	



Ø 600mm Suspension

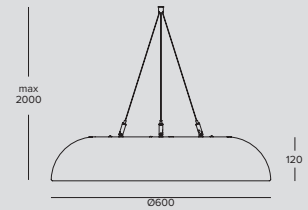

LED / 18W / DIRECT / VWFL					⊕	3.6	IP20
	3000K	H(m)	D(m)	E _{max} (lx)	Power supply	Colour	3000K
	Ra80		98°		220-240Vac	○	1T4052
	Fixture Power	18W	1	2.28	551		
	Source Flux	1148lm	2	4.56	138		
	Fixture Flux	1148lm	3	6.84	61		
	Efficacy	64lm/W	4	9.12	34		
TS810	I _{max} =480cd/klm	I _{max}	551cd	5	11.41	22	

LED / 18W / DIFFUSE / VWFL					⊕	3.6	IP20
	3000K	H(m)	D(m)	E _{max} (lx)	Power supply	Colour	3000K
	Ra80		96°		220-240Vac	○	1T4051
	Fixture Power	18W	1	2.20	586		
	Source Flux	1295lm	2	4.41	147		
	Fixture Flux	1295lm	3	6.61	65		
	Efficacy	72lm/W	4	8.82	37		
TS809	I _{max} =453cd/klm	I _{max}	586cd	5	11.02	23	



Ø 600mm Ceiling mounted

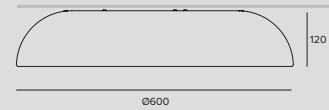

LED / 18W / DIRECT / VWFL



		3000K	H(m)	D(m)	E _{max} (lx)	
		Ra80		101*		
Fixture Power	18W	1	2.41	546		
Source Flux	1199lm	2	4.83	137		
Fixture Flux	1199lm	3	7.24	61		
Efficacy	67lm/W	4	9.65	34		
TS808	I _{max} =456cd/klm	I _{max}	546cd	5	12.07	22

Power supply	Colour	3000K
220-240Vac	○	1T4054

LED / 18W / DIFFUSE / VWFL



		3000K	H(m)	D(m)	E _{max} (lx)	
		Ra80		98*		
Fixture Power	18W	1	2.30	555		
Source Flux	1249lm	2	4.61	139		
Fixture Flux	1249lm	3	6.91	62		
Efficacy	69lm/W	4	9.21	35		
TS807	I _{max} =444cd/klm	I _{max}	555cd	5	11.52	22

Power supply	Colour	3000K
220-240Vac	○	1T4053

Accessories

Canopy



Colour Code

○ **1T3978**

Canopy.

Control systems



Code

1T5351

A Wireless Trailing Edge / IGBT dimmer managed using Bluetooth 4.0 technology. It works with LED 230V-AC modules, dimmable LED sources and halogen lamps. It can be installed inside a standard 503 wall switch box, lighting fixtures or ceiling canopies.

It can manage systems with a maximum absorption of 150W.

The module is wireless controlled using a Casambi app for smartphones and tablets or traditional wall switches.

IP20

PANTHEON



Ø 400mm

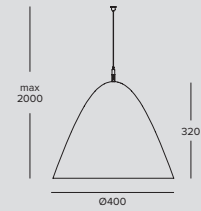

LED / 10W / WFL								
	3000K	H(m)	D(m)	E _{max} (lx)	Power supply	Colour	3000K	
	Ra84		59°		220-240Vac	○	1T4055	
	Fixture Power	10W	1	1.14	902	220-240Vac	●	1T4056
	Source Flux	708lm	2	2.28	225			
	Fixture Flux	708lm	3	3.42	100			
	Efficacy	71lm/W	4	4.56	56			
TS789	l _{max} =1274cd/klm	l _{max}	902cd	5	5.70	36		

Accessories

Canopy	
Colour	Code
○	1T3978
●	1T5430

Canopy.

Control systems	
Code	
	1T5351

A Wireless Trailing Edge / IGBT dimmer managed using Bluetooth 4.0 technology. It works with LED 230V-AC modules, dimmable LED sources and halogen lamps. It can be installed inside a standard 503 wall switch box, lighting fixtures or ceiling canopies.

It can manage systems with a maximum absorption of 150W.

The module is wireless controlled using a Casambi app for smartphones and tablets or traditional wall switches.

IP20



Dermalogica

Architect
Limeblue

Lighting Design
Normalite

Photographer
Limeblue

Country
London,
UK

CCTLED PENDANT

GENERAL INFO

Suspension with diffused downlight for high output LED lamps.

Ø317mm

LED

Chip on Board

From 2756lm to 3755lm

3000K – 4000K

Ra84

Ra90 - To order this version it is necessary to add the suffix "90" at the end of the standard code.

Ra97 on request

PRODUCT EFFICACY

Up to 80lm/W

OPTICS

FL

POWER SUPPLY

Electronic – DALI - Emergency - DALI Emergency

Casambi control: the DALI version is fitted with special accessories.

MATERIAL

Black painted metal canopy and black painted die-cast aluminium heat sink. Microprismatic transparent polycarbonate dome refractor optic.

A professional suspension fixture from the CCTLED range. Available with a faceted transparent polycarbonate optic for diffused lighting, complete with micro prismatic dome refractor to screen the source and to distribute the light softly.

Used together with the recessed version makes it possible to maintain the same effect and the same family feeling but with different installation types.





Ambient

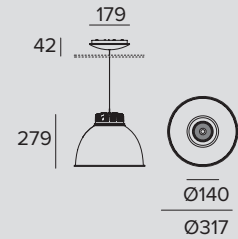

LED / 18W / FL



	3000K	H(m)	D(m)	E _{max} (lx)		
	Ra84		39°			
	Fixture Power	20W	1	0.71	2757	
	Source Flux	2756lm	2	1.42	689	
	Fixture Flux	1663lm	3	2.12	306	
	Efficacy	82lm/W	4	2.83	172	
T5721	I _{max} =1000cd/klm	I _{max}	2757cd	5	3.54	110

Kg	Certificate	Driver	3000K	4000K
2	ENEC	EL.	1T3274	1T3275
2	ENEC	DALI	1T3298	1T3299
2.7		EL. EM.	1T3322	1T3323
2.7		DALI EM.	1T3346	1T3347

LED / 25W / FL



	3000K	H(m)	D(m)	E _{max} (lx)		
	Ra84		39°			
	Fixture Power	29W	1	0.71	3662	
	Source Flux	3663lm	2	1.42	916	
	Fixture Flux	2210lm	3	2.12	407	
	Efficacy	76lm/W	4	2.83	229	
T5715	I _{max} =1000cd/klm	I _{max}	3662cd	5	3.54	146

Kg	Certificate	Driver	3000K	4000K
2	ENEC	EL.	1T3272	1T3273
2	ENEC	DALI	1T3296	1T3297
2.7		EL. EM.	1T3320	1T3321
2.7		DALI EM.	1T3344	1T3345

Accessories

Decorative Ring



Colour	Code
●	1T4061
○	1T4062

Dissipator cover.

Control systems



Code
1T5349

Wireless control unit for DALI fixtures.
It generates a local DALI bus that can control individual fixtures.
The module can be connected to an existing DALI network.
The module is wireless controlled using a Casambi app for smartphones and tablets using Bluetooth 4.0 technology.
The devices create a wireless mesh network that can control up to 128 fixtures.
IP20.



Code
1T5352

IP20 Extender for wireless control of DALI fixtures.
It generates a local DALI bus with the capacity to drive up to 64 fixtures.
Can control DALI fixtures in indoor applications.
It is also equipped with a relay that can control non-dimmable fixtures up to a maximum of 6A.

CCTLED TUBE

GENERAL INFO

Ceiling-mounted, pendant, wall-mounted or track-mounted luminaire for high output LED sources.
Ø180mm

LED

Chip on board
From 2269lm to 4462lm
3000K – 4000K
Ra84
Ra90 - To order this version it is necessary to add the suffix "90" at the end of the standard code
Ra97 on request.

PRODUCT EFFICACY

Up to 118lm/W

OPTICS

SMART HE – TECH – FEEL – DEEP

POWER SUPPLY

Electronic – DALI - Emergency - DALI Emergency
Controllo Casambi: versioni DALI dotate di appositi accessori.

MATERIAL

Painted aluminium body. Painted polycarbonate decorative squared ring. Black painted die-cast aluminium internal frame and heat sink.

Belongs to the CCTLED range with different installation solutions: ceiling, suspension, wall and track. It also comes in the same power supply and optics in order to use the same fixture in an entire project. The same uniform quality effect with different installation solutions.





Basilica of the Sacred Heart

Country
Grenoble - France

01 CCTLED Tube



The same optical solutions in the “downlight” version

SMART, TECH, FEEL as well as a DEEP high performance version. Optics for a variety of environments from retail, hospitality right up to offices with the DEEP optic for heights of more than 6 metres.



Almacruz Hotel

Lighting Design
Katerina Jofre

Photographer
Nicolás Saieh

Country
Santiago - Chile

Project
Mas Fernades
arquitectos
asociados

CCTLED TUBE



Smart Facetted

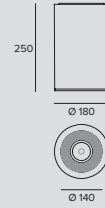

LED / 18W / FACETTED / VWFL



	3000K	H(m)	D(m)	Emax(lx)		
	Ra84		82°			
	Fixture Power	21W	1	1.73	1466	
	Source Flux	2756lm	2	3.45	367	
	Fixture Flux	2360lm	3	5.18	163	
	Efficacy	111lm/W	4	6.90	92	
	TS658	Imax=592cd/klm	Imax	1632cd	5	8.63

Kg	Certificate	Driver	Colour	3000K	4000K
2	ENEC	EL.	○	1T3162	1T3163
2	ENEC	DALI	○	1T3182	1T3183
2.5		EL. EM.	○	1T3202	1T3203
2.5		DALI EM.	○	1T3222	1T3223

LED / 25W / FACETTED / VWFL



	3000K	H(m)	D(m)	Emax(lx)		
	Ra84		82°			
	Fixture Power	29W	1	1.73	1963	
	Source Flux	3663lm	2	3.45	491	
	Fixture Flux	3160lm	3	5.18	218	
	Efficacy	109lm/W	4	6.90	123	
	TS653	Imax=597cd/klm	Imax	2185cd	5	8.63

Kg	Certificate	Driver	Colour	3000K	4000K
2	ENEC	EL.	○	1T3174	1T3175
2	ENEC	DALI	○	1T3194	1T3195
2.5		EL. EM.	○	1T3214	1T3215
2.5		DALI EM.	○	1T3234	1T3235



Smart Matt



LED / 18W / MATT / VWFL



	3000K	H(m)	D(m)	Emax(lx)		
	Ra84		72°			
	Fixture Power	21W	1	1.46	1904	
	Source Flux	2756lm	2	2.91	476	
	Fixture Flux	2337lm	3	4.37	212	
	Efficacy	110lm/W	4	5.82	119	
	TS657	Imax=691cd/klm	Imax	1904cd	5	7.28

Kg	Certificate	Driver	Colour	3000K	4000K
2	ENEC	EL.	○	1T3164	1T3165
2	ENEC	EL.	●	1T4455	
2	ENEC	DALI	○	1T3184	1T3185
2	ENEC	DALI	●	1T4457	
2.5		EL. EM.	○	1T3204	1T3205
2.5		DALI EM.	○	1T3224	1T3225

LED / 25W / MATT / VWFL



	3000K	H(m)	D(m)	Emax(lx)		
	Ra84		72°			
	Fixture Power	29W	1	1.46	2527	
	Source Flux	3663lm	2	2.92	632	
	Fixture Flux	3106lm	3	4.37	281	
	Efficacy	107lm/W	4	5.83	158	
	TS654	Imax=690cd/klm	Imax	2527cd	5	7.29

Kg	Certificate	Driver	Colour	3000K	4000K
2	ENEC	EL.	○	1T3176	1T3177
2	ENEC	EL.	●	1T4456	
2	ENEC	DALI	○	1T3196	1T3197
2	ENEC	DALI	●	1T4458	
2.5		EL. EM.	○	1T3216	1T3217
2.5		DALI EM.	○	1T3236	1T3237



Tech Secondary faceted

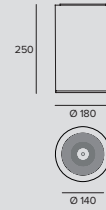

LED / 15W / FACETTED / WFL



	3000K	H(m)	D(m)	E _{max} (lx)		
Ra84			70°			
Fixture Power	17W	1	1.39	1689		
Source Flux	2520lm	2	2.78	422		
Fixture Flux	2070lm	3	4.16	188		
Efficacy	120lm/W	4	5.55	106		
TS660	Imax=721cd/klm	Imax	1817cd	5	6.94	68

Kg	Certificate	Driver	Colour	3000K	4000K
2	ENEC	EL.	○	1T3166	1T3167
2	ENEC	DALI	○	1T3186	1T3187
2.5		EL. EM.	○	1T3206	1T3207
2.5		DALI EM.	○	1T3226	1T3227

LED / 21W / FACETTED / WFL



	3000K	H(m)	D(m)	E _{max} (lx)		
Ra84			70°			
Fixture Power	24W	1	1.39	2172		
Source Flux	3240lm	2	2.78	543		
Fixture Flux	2662lm	3	4.16	241		
Efficacy	111lm/W	4	5.55	136		
TS655	Imax=721cd/klm	Imax	2336cd	5	6.94	87

Kg	Certificate	Driver	Colour	3000K	4000K
2	ENEC	EL.	○	1T3178	1T3179
2	ENEC	DALI	○	1T3198	1T3199
2.5		EL. EM.	○	1T3218	1T3219
2.5		DALI EM.	○	1T3238	1T3239



Tech Secondary matt

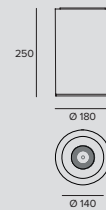

LED / 15W / MATT / WFL



	3000K	H(m)	D(m)	E _{max} (lx)		
Ra84			69°			
Fixture Power	17W	1	1.38	1679		
Source Flux	2520lm	2	2.77	420		
Fixture Flux	2070lm	3	4.15	187		
Efficacy	120lm/W	4	5.54	105		
TS659	Imax=733cd/klm	Imax	1847cd	5	6.92	67

Kg	Certificate	Driver	Colour	3000K	4000K
2	ENEC	EL.	○	1T3168	1T3169
2	ENEC	EL.	●	1T4459	
2	ENEC	DALI	○	1T3188	1T3189
2	ENEC	DALI	●	1T4461	
2.5		EL. EM.	○	1T3208	1T3209
2.5		DALI EM.	○	1T3228	1T3229

LED / 21W / MATT / WFL



	3000K	H(m)	D(m)	E _{max} (lx)		
Ra84			69°			
Fixture Power	24W	1	1.38	2159		
Source Flux	3240lm	2	2.77	540		
Fixture Flux	2662lm	3	4.15	240		
Efficacy	111lm/W	4	5.54	135		
TS656	Imax=733cd/klm	Imax	2375cd	5	6.92	86

Kg	Certificate	Driver	Colour	3000K	4000K
2	ENEC	EL.	○	1T3180	1T3181
2	ENEC	EL.	●	1T4460	
2	ENEC	DALI	○	1T3200	1T3201
2	ENEC	DALI	●	1T4462	
2.5		EL. EM.	○	1T3220	1T3221
2.5		DALI EM.	○	1T3240	1T3241

CCTLED TUBE



Feel Facetted

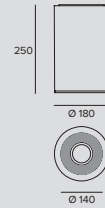

LED / 14W / FACETTED / VWFL



	3000K	H(m)	D(m)	E _{max} (lx)		
	Ra84			73°		
	Fixture Power	15W	1	1.48	967	
	Source Flux	2269lm	2	2.96	242	
	Fixture Flux	1423lm	3	4.44	107	
	Efficacy	93lm/W	4	5.92	60	
TS662	l _{max} =501cd/klm	l _{max}	1137cd	5	7.40	39

Kg	Certificate	Driver	Colour	3000K	4000K
2	ENEC	EL.	○	1T3170	1T3171
2	ENEC	DALI	○	1T3190	1T3191
2.5		EL. EM.	○	1T3210	1T3211
2.5		DALI EM.	○	1T3230	1T3231



Feel Matt

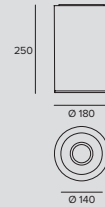

LED / 14W / MATT / WFL



	3000K	H(m)	D(m)	E _{max} (lx)		
	Ra84			70°		
	Fixture Power	15W	1	1.41	898	
	Source Flux	2269lm	2	2.82	225	
	Fixture Flux	1268lm	3	4.23	100	
	Efficacy	83lm/W	4	5.64	56	
TS663	l _{max} =415cd/klm	l _{max}	941cd	5	7.05	36

Kg	Certificate	Driver	Colour	3000K	4000K
2	ENEC	EL.	○	1T3172	1T3173
2	ENEC	EL.	●	1T4463	
2	ENEC	DALI	○	1T3192	1T3193
2	ENEC	DALI	●	1T4464	
2.5		EL. EM.	○	1T3212	1T3213
2.5		DALI EM.	○	1T3232	1T3233



Deep



LED / 33W / SP



	3000K	H(m)	D(m)	E _{max} (lx)
Ra84			21°	
Fixture Power	36W	1	0.36	24354
Source Flux	4351lm	2	0.72	6089
Fixture Flux	3457lm	3	1.09	2706
Efficacy	97lm/W	4	1.45	1522
TS708	I _{max} =5597cd/klm	I _{max}	24354cd	5
			1.81	974

Kg	Certificate	Driver	Colour	3000K	4000K
2.1	ENEC	EL.	○	1T3433	1T3434
2.1	ENEC	EL.	●	1T4451	
2.1	ENEC	DALI	○	1T3437	1T3438
2.1	ENEC	DALI	●	1T4453	
2.6		EL. EM.	○	1T3441	1T3442
2.6		DALI EM.	○	1T3445	1T3446

LED / 33W / FL



	3000K	H(m)	D(m)	E _{max} (lx)
Ra84			33°	
Fixture Power	36W	1	0.59	10995
Source Flux	4351lm	2	1.18	2749
Fixture Flux	3378lm	3	1.78	1222
Efficacy	95lm/W	4	2.37	687
TS709	I _{max} =2537cd/klm	I _{max}	11039cd	5
			2.96	440

Kg	Certificate	Driver	Colour	3000K	4000K
2.1	ENEC	EL.	○	1T3435	1T3436
2.1	ENEC	EL.	●	1T4452	
2.1	ENEC	DALI	○	1T3439	1T3440
2.1	ENEC	DALI	●	1T4454	
2.6		EL. EM.	○	1T3443	1T3444
2.6		DALI EM.	○	1T3447	1T3448

Related codes

Mounting System

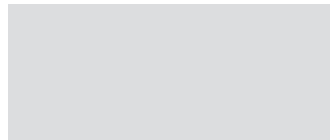

Driver	Colour	Code
EL./EL. EM.	●	1T0123
DALI	●	1T0123DA
EL./EL. EM.	●	1T4466
DALI	●	1T4467
DALI EM.	●	1T3243

Ceiling mounting kit.

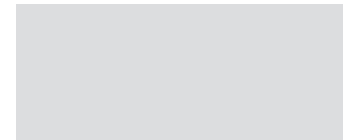

L	Driver	Colour	Code
1000	EL./EL. EM.	○	1T0124
1000	DALI	○	1T0124DA
6000	EL./EL. EM.	●	1T4469
6000	DALI	●	1T4470
1000	DALI EM.	○	1T3244

Suspension kit.

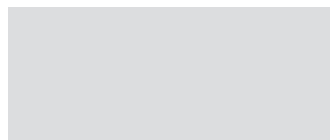

L	Driver	Colour	Code
2000	EL./EL. EM.	○	1T3245
2000	DALI	○	1T3246
6000	EL./EL. EM.	●	1T4472
6000	DALI	●	1T4473
2000	DALI EM.	○	1T3247

Double suspension kit.

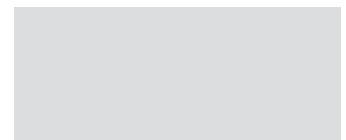

Driver	Colour	Code
EL./EL. EM.	○	1T3449
DALI	○	1T3450
EL./EL. EM.	●	1T4475
DALI	●	1T4476
DALI EM.	○	1T3451

Wall mounting kit.

CCTLED TUBE

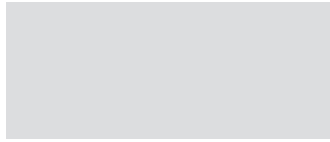

Driver	Colour	Code
EL./EL. EM.	○	1T3452
DALI	○	1T3453
EL./EL. EM.	●	1T4478
DALI	●	1T4479
DALI EM.	○	1T3454

Wall mounting kit for double emission.

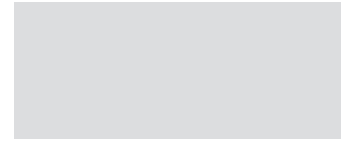

Driver	Colour	Code
EL.	○	1T0130
DALI	○	1T0130DA
EL.	●	1T4465

Eurostandard Plus track kit.

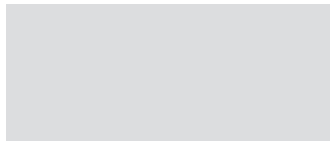

Driver	Colour	Code
EL.	○	1T7402

Eurostandard Plus track suspension kit.

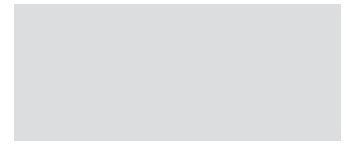

Driver	Colour	Code
DALI	○	1T3242DA

Eurostandard Plus track suspension kit.

Accessories

Decorative Ring



Ø	Colour	Code
180	○	1T3248

Round ring.

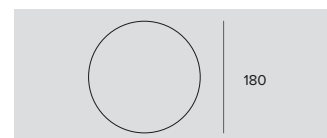

Ø	Colour	Code
180	○	1T3249

Square ring with micro prismatic diffusive screen.



Ø	Colour	Code
180	○	1T3250

Square ring with external silk screen printed screen.



Ø	Colour	Code
180	○	1T3251

XL ring.
For the TECH version.

Adapter

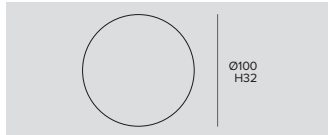

Ø	H	Driver	Colour	Code
100	32	EL.	○	1T2221
100	32	EL.	●	1T2220
100	32	EL.	●	1T2219

Ceiling mounting adapter for electrified track type projectors.

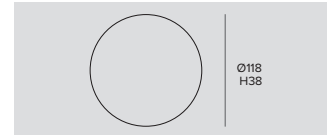

Ø	H	Driver	Colour	Code
118	38	DALI	○	9000/BPU-D-W
118	38	DALI	●	9000/BPU-D-B
118	38	DALI	●	9000/BPU-D-G

Ceiling mounting adapter for electrified track type projectors.

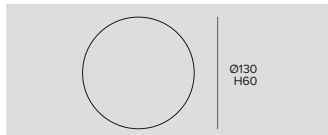

Cutout hole	Ø	H	Driver	Colour	Code
Ø105/125	130	60	EL.	○	1T2223
Ø105/125	130	60	EL.	●	1T2222
Ø105/125	130	60	EL.	●	1T2224

Recessed mounting adapter for electrified track type projectors.
1T2222 - To be completed with 1T2220.
1T2223 - To be completed with 1T2221.
1T2224 - To be completed with 1T2219.

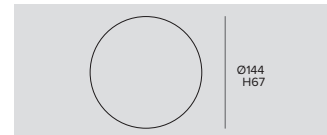

Cutout hole	Ø	H	Driver	Colour	Code
Ø125/130	144	67	DALI	○	9000/BRU-W
Ø125/130	144	67	DALI	●	9000/BRU-B
Ø125/130	144	67	DALI	●	9000/BRU-G

Recessed mounting adapter for electrified track type projectors.
9000/BRU-G - To be completed with 9000/BPU-D-G.
9000/BRU-W - To be completed with 9000/BPU-D-W.
9000/BRU-B - To be completed with 9000/BPU-D-B.

Control systems

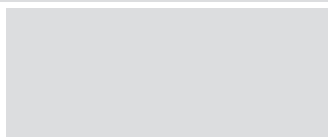

Code
1T5349

Wireless control unit for DALI fixtures.
 It generates a local DALI bus that can control individual fixtures.
 The module can be connected to an existing DALI network.
 The module is wireless controlled using a Casambi app for smartphones and tablets using Bluetooth 4.0 technology.
 The devices create a wireless mesh network that can control up to 128 fixtures.
 IP20.

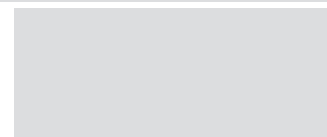

Code
1T5352

IP20 Extender for wireless control of DALI fixtures.
 It generates a local DALI bus with the capacity to drive up to 64 fixtures.
 Can control DALI fixtures in indoor applications.
 It is also equipped with a relay that can control non-dimmable fixtures up to a maximum of 6A.

BEBOP

Ceiling / Suspension

GENERAL INFO

LED pendant and ceiling mounted for direct diffuse lighting.
Ø90mm

LED

Chip on board
From 1706lm to 1750lm
3000K – 4000K
Ra84
Ra90 - To order this version it is necessary to add the suffix "90" at the end of the standard code.

PRODUCT EFFICACY

Up to 91lm/W

OPTICS

MWFL - WFL

POWER SUPPLY

Electronic – DALI

MATERIAL

Painted aluminium body. Painted polycarbonate front element. Die-cast aluminium finned internal heat sink.

A range of high performance products characterised by simple, soft and rounded lines. Available in three different versions for ceiling mounted, suspension and recessed installation.

In all versions the LED lamps are retracted and hidden from view to ensure optimum visual comfort. The flexible installation makes it possible to use the same type of light in environments with different architectural characteristics.





Suspension

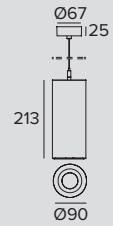

LED / 13W / MWFL



		3000K	H(m)	D(m)	E _{max} (lx)
Ra84				48°	
Fixture Power	15W	1	0.90	1823	
Source Flux	1706lm	2	1.79	456	
Fixture Flux	1310lm	3	2.69	203	
Efficacy	90lm/W	4	3.59	114	
TS901	I _{max} =1079cd/klm	I _{max}	1840cd	5	4.48
					73

Driver	Colour	3000K	4000K
EL.	○	1T4764EL	1T4765EL
EL.	●	1T5418EL	1T5419EL

LED / 13W / WFL



		3000K	H(m)	D(m)	E _{max} (lx)
Ra84				64°	
Fixture Power	15W	1	1.24	1087	
Source Flux	1706lm	2	2.49	272	
Fixture Flux	1285lm	3	3.73	121	
Efficacy	89lm/W	4	4.98	68	
TS900	I _{max} =688cd/klm	I _{max}	1174cd	5	6.22
					43

Driver	Colour	3000K	4000K
EL.	○	1T4762EL	1T4763EL
EL.	●	1T5420EL	1T5421EL



Ceiling

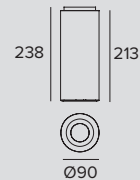

LED / 13W / MWFL



		3000K	H(m)	D(m)	E _{max} (lx)
Ra84				48°	
Fixture Power	15W	1	0.90	1823	
Source Flux	1706lm	2	1.79	456	
Fixture Flux	1310lm	3	2.69	203	
Efficacy	90lm/W	4	3.59	114	
TS901	I _{max} =1079cd/klm	I _{max}	1840cd	5	4.48
					73

Driver	Colour	3000K	4000K
EL.	○	1T4768EL	1T4769EL
EL.	●	1T5414EL	1T5415EL

LED / 13W / WFL



		3000K	H(m)	D(m)	E _{max} (lx)
Ra84				64°	
Fixture Power	15W	1	1.24	1087	
Source Flux	1706lm	2	2.49	272	
Fixture Flux	1285lm	3	3.73	121	
Efficacy	89lm/W	4	4.98	68	
TS900	I _{max} =688cd/klm	I _{max}	1174cd	5	6.22
					43

Driver	Colour	3000K	4000K
EL.	○	1T4766EL	1T4767EL
EL.	●	1T5416EL	1T5417EL

GLOBO

GENERAL INFO

Diffused emission suspension fixture for halogen, LED lamp or compact fluorescent lamps with E27 lamp holder.
Ø350mm

LED

Lamp not included

MATERIAL

Metal frame and opaline glass diffuser.

Diffused emission suspension fixture. The high quality opaline glass diffuser ensure maximum light diffusion and perfect distribution over surfaces

It can be fitted with any type of lamp with an E27 adapter including LED.



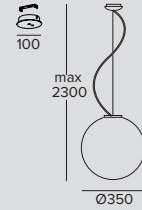

FLUO/HAL/LED / max 100W ⊕ 2.3 IP20

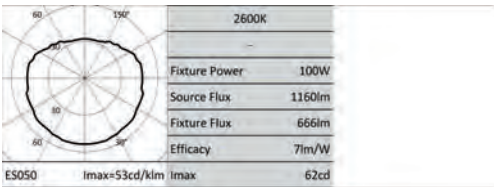

Power supply	Colour	Code
220-240Vac	●	344540

Accessories

Control systems

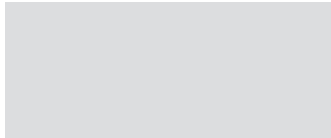

Code
1T5351

A Wireless Trailing Edge / IGBT dimmer managed using Bluetooth 4.0 technology. It works with LED 230V-AC modules, dimmable LED sources and halogen lamps. It can be installed inside a standard 503 wall switch box, lighting fixtures or ceiling canopies. It can manage systems with a maximum absorption of 150W. The module is wireless controlled using a Casambi app for smartphones and tablets or traditional wall switches.

IP20

WASABI

GENERAL INFO

Diffused LED light suspension fixture.
Ø103mm – Ø125mm – Ø163mm

LED

LED module 230V
From 806lm to 825lm
3000K
Ra80

PRODUCT EFFICACY

Up to 60lm/W

OPTICS

MWFL

POWER SUPPLY

Electronic
Casambi control system available by using a dedicated accessory (230Vac LED module max 150W).

MATERIAL

Satin polished and painted heat dissipator.
Diffuser in glazed opal glass.

A suspension fixture with soft lines inspired by the orient that combines the lightness of glass with the technology in the LED module as well as the particular heatsink with a shape inspired by nature.

No driver necessary thanks to the 230V LED module for maximum installation flexibility. Available in three different sizes.





Ø 163mm

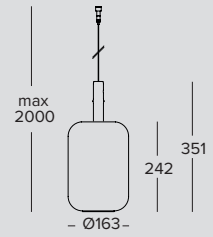

LED / 13W



	3000K	H(m)	D(m)	E _{max} (lx)
Ra80			21*	
Fixture Power	14W	1	0.38	376
Source Flux	808lm	2	0.75	94
Fixture Flux	808lm	3	1.13	42
Efficacy	59lm/W	4	1.50	24
I _{max}	376cd	5	1.88	15

Power supply	Colour	3000K
220-240Vac	○	1T3979
220-240Vac	●	1T3980



Ø 125mm

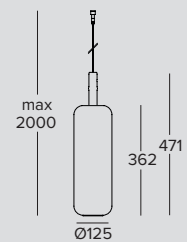

LED / 13W



	3000K	H(m)	D(m)	E _{max} (lx)
Ra80			9*	
Fixture Power	14W	1	0.17	202
Source Flux	806lm	2	0.33	50
Fixture Flux	806lm	3	0.50	22
Efficacy	59lm/W	4	0.66	13
I _{max}	202cd	5	0.83	8

Power supply	Colour	3000K
220-240Vac	○	1T3991
220-240Vac	●	1T3992



Ø 103mm

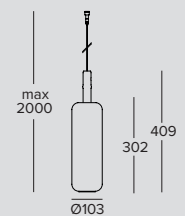

LED / 13W



	3000K	H(m)	D(m)	E _{max} (lx)
Ra80			14*	
Fixture Power	14W	1	0.25	319
Source Flux	825lm	2	0.49	80
Fixture Flux	825lm	3	0.74	35
Efficacy	60lm/W	4	0.99	20
I _{max}	319cd	5	1.23	13

Power supply	Colour	3000K
220-240Vac	○	1T3985
220-240Vac	●	1T3986

Canopy



Colour	Code
○	1T3978
●	1T5430

Canopy.

DECANTER

GENERAL INFO

LED suspension for direct diffuse lighting.
Ø170mm – Ø320mm – Ø480mm

LED

Circular LED board
From 264lm to 1553lm
3000K
Ra84

PRODUCT EFFICACY

Up to 104lm/W

OPTICS

VWFL

POWER SUPPLY

Electronic

MATERIAL

Disc made of Baydur® (large and medium models) or aluminium (small version). Aluminium stem and decorative canopy matt painted. Microprismatic diffuser in transparent PMMA. Painted decorative canopy.

Its sinuous shape is the result of research into innovative materials and moulding techniques that make it possible to obtain extremely thin thicknesses; the result is a light suspension fixture with excellent mechanical resistance.

The special micro prismatic screen ensures perfect, particularly homogeneous light diffusion that is comfortable to the eye. Available in three different sizes, from extremely small for decorative light up to an excellent light on work surfaces.





Ø 170mm

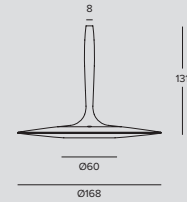

LED / 4W / VWFL ± 1 IP20

		3000K	H(m)	D(m)	E _{max} (lx)	Driver	Colour	3000K
Ra84				83°		EL.	○	1T4076
Fixture Power	6W	1	1.78	140		EL.	●	1T4077
Source Flux	264lm	2	3.56	35				
Fixture Flux	264lm	3	5.34	16				
Efficacy	44lm/W	4	7.12	9				
T5626	I _{max} =532cd/klm	I _{max}	140cd	5	8.90			



Ø 320mm

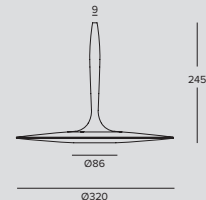

LED / 9W / VWFL ± 2,4 IP20

		3000K	H(m)	D(m)	E _{max} (lx)	Driver	Colour	3000K
Ra84				83°		EL.	○	1T4082
Fixture Power	10W	1	1.76	295		EL.	●	1T4083
Source Flux	528lm	2	3.53	74				
Fixture Flux	528lm	3	5.29	33				
Efficacy	53lm/W	4	7.06	18				
T5627	I _{max} =558cd/klm	I _{max}	295cd	5	8.82			



Ø 480mm

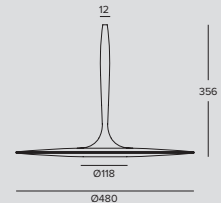

LED / 13W / VWFL ± 5,4 IP20

		3000K	H(m)	D(m)	E _{max} (lx)	Driver	Colour	3000K
Ra84				84°		EL.	○	1T4088
Fixture Power	15W	1	1.80	851		EL.	●	1T4089
Source Flux	1553lm	2	3.60	213				
Fixture Flux	1553lm	3	5.40	95				
Efficacy	104lm/W	4	7.21	53				
T5628	I _{max} =549cd/klm	I _{max}	853cd	5	9.01			

MONETA

Ceiling and suspension luminaire

GENERAL INFO

Direct emission ceiling and suspension fixture for LED dimmable.

Ø140mm

LED

LED module 230V

871lm

3000K

Ra90

PRODUCT EFFICACY

51lm/W

OPTICS

VWFL

POWER SUPPLY

No driver necessary

Casambi control system available by using a dedicated accessory (230Vac LED module max 150W).

MATERIAL

Matt painted aluminium body complete with opaline polycarbonate diffuser.

A range of products with three different versions for three different installation types: ceiling mounted, suspension and wall mounted.

Just over 3cm thick to exploit the potential of the LED lamp to the full; compact size, excellent performance, low consumption and no driver make this a product where aesthetics and technology combine.

No driver necessary thanks to the 230V LED module for maximum installation flexibility.

Available also in wall mounted version.





Suspension

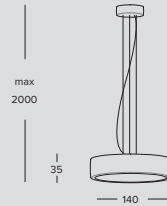

LED / 17W / VWFL



		3000K	H(m)	D(m)	E _{max} (lx)	
		Ra90		114°		
Fixture Power	17W	1	3.07	303		
Source Flux	871lm	2	6.13	76		
Fixture Flux	871lm	3	9.20	34		
Efficacy	51lm/W	4	12.26	19		
TS771	I _{max} =348cd/klm	I _{max}	303cd	5	15.33	12

Power supply Colour 3000K

220-240Vac ○ **1T3768**

220-240Vac ● **1T3769**



Ceiling

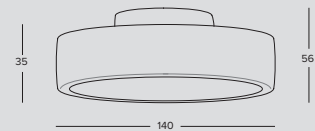

LED / 17W / VWFL



		3000K	H(m)	D(m)	E _{max} (lx)	
		Ra90		114°		
Fixture Power	17W	1	3.07	303		
Source Flux	871lm	2	6.13	76		
Fixture Flux	871lm	3	9.20	34		
Efficacy	51lm/W	4	12.26	19		
TS771	I _{max} =348cd/klm	I _{max}	303cd	5	15.33	12

Power supply Colour 3000K

220-240Vac ○ **1T3765**

220-240Vac ● **1T3766**

Accessories

Control systems



Code

1T5351

A Wireless Trailing Edge / IGBT dimmer managed using Bluetooth 4.0 technology. It works with LED 230V-AC modules, dimmable LED sources and halogen lamps. It can be installed inside a standard 503 wall switch box, lighting fixtures or ceiling canopies.

It can manage systems with a maximum absorption of 150W.

The module is wireless controlled using a Casambi app for smartphones and tablets or traditional wall switches.

IP20

Indoor

**Wall mounted
luminaires**

Wall mounted luminaires

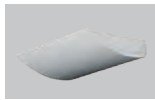

518
FLOOD



520
HALL

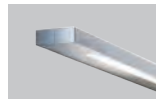

522
SLIM



524
MINIMINIMA



526
MONETA

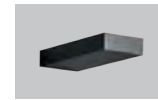

528
BRAQUE



530
BOTTONE



532
OSIRIDE



538
PROFESSIONAL



FLOOD

GENERAL INFO

Wall mounted fixture with indirect light emission for LED sources.
224x330mm
224x700mm

LED

Linear boards
From 2610lm to 5220lm
3000K
Ra80
Ra90 - To order this version it is necessary to add the suffix "90" at the end of the standard code.

PRODUCT EFFICACY

Up to 119lm/W

OPTICS

VWFL

POWER SUPPLY

DALI
Casambi control: the DALI version is fitted with special accessories.

MATERIAL

Painted metal body. Transparent protective screen.

Wall mounted fixture with indirect light available in two different lengths with two different power supplies for soft and comfortable indirect light. It is suitable for lighting small and large spaces.

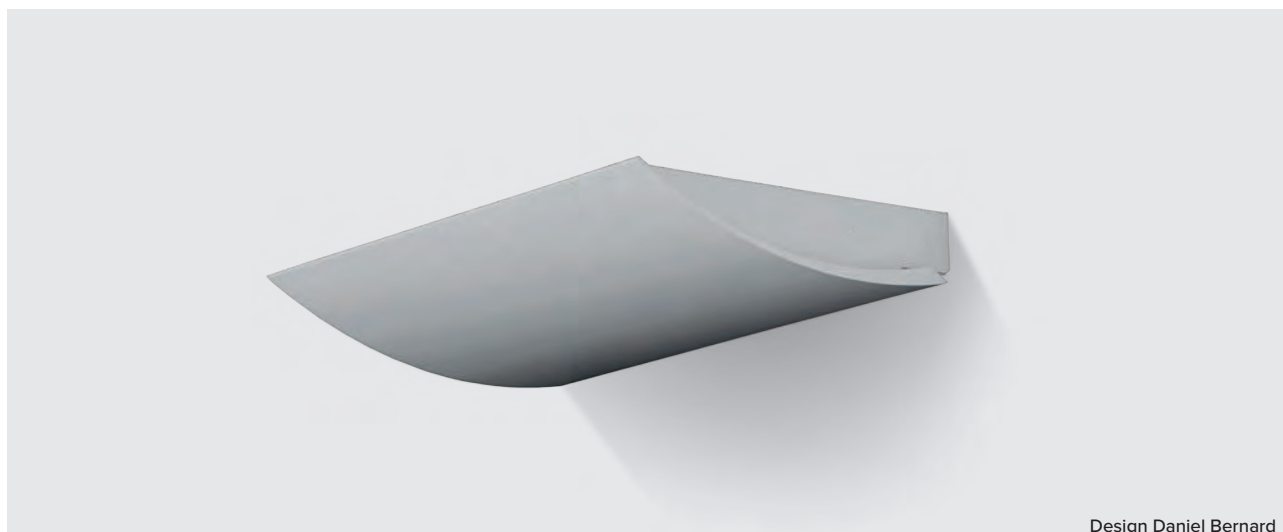

Design Daniel Bernard

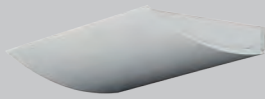

L. 330mm

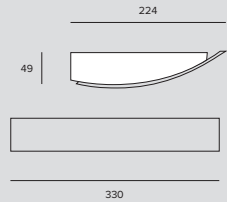

LED / 18W / VWFL



		3000K	H(m)	D(m)	Emax(lx)	
		Ra80		117°		
Fixture Power	22W	1	3.29	875		
Source Flux	2610lm	2	6.57	219		
Fixture Flux	2432lm	3	9.86	97		
Efficacy	111lm/W	4	13.14	55		
TS894	Imax=335cd/klm	Imax	875cd	5	16.43	35

Driver	Colour	3000K
DALI	○	1T4512
DALI	●	1T4514

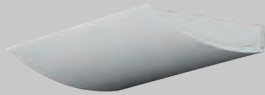

L. 700mm

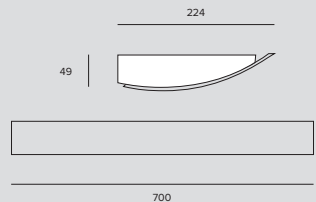

LED / 36W / VWFL



		3000K	H(m)	D(m)	Emax(lx)	
		Ra80		117°		
Fixture Power	41W	1	3.29	1751		
Source Flux	5220lm	2	6.57	438		
Fixture Flux	4865lm	3	9.86	195		
Efficacy	119lm/W	4	13.14	109		
TS894	Imax=335cd/klm	Imax	1751cd	5	16.43	70

Driver	Colour	3000K
DALI	○	1T4513
DALI	●	1T4515

Accessories

Control systems

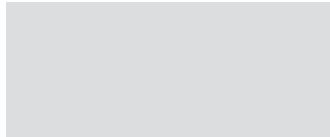

Code

1T5349

Wireless control unit for DALI fixtures. It generates a local DALI bus that can control individual fixtures. The module can be connected to an existing DALI network. The module is wireless controlled using a Casambi app for smartphones and tablets using Bluetooth 4.0 technology. The devices create a wireless mesh network that can control up to 128 fixtures. IP20.

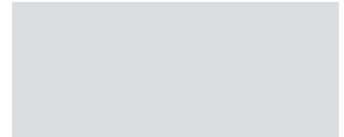

Code

1T5352

IP20 Extender for wireless control of DALI fixtures. It generates a local DALI bus with the capacity to drive up to 64 fixtures. Can control DALI fixtures in indoor applications. It is also equipped with a relay that can control non-dimmable fixtures up to a maximum of 6A.

HALL

GENERAL INFO

Wall mounted fixture with indirect light emission for LED sources.

297x330x112mm

LED

LED Low Power High Efficiency Linear boards

5160lm

3000K

Ra80

Ra90 - To order this version it is necessary to add the suffix "90" at the end of the standard code.

PRODUCT EFFICACY

111lm/W

OPTICS

ASYM

POWER SUPPLY

DALI - Casambi on board

MATERIAL

Painted metal body. Diffuse protective screen.

Professional applique with indirect light emission with an asymmetrical optic. The strongly asymmetric emission allows for deep indirect lighting of large spaces.

Used on its own it is capable of producing soft and comfortable light: combined with direct lighting on the other hand it balances and improves visual comfort throughout the space.

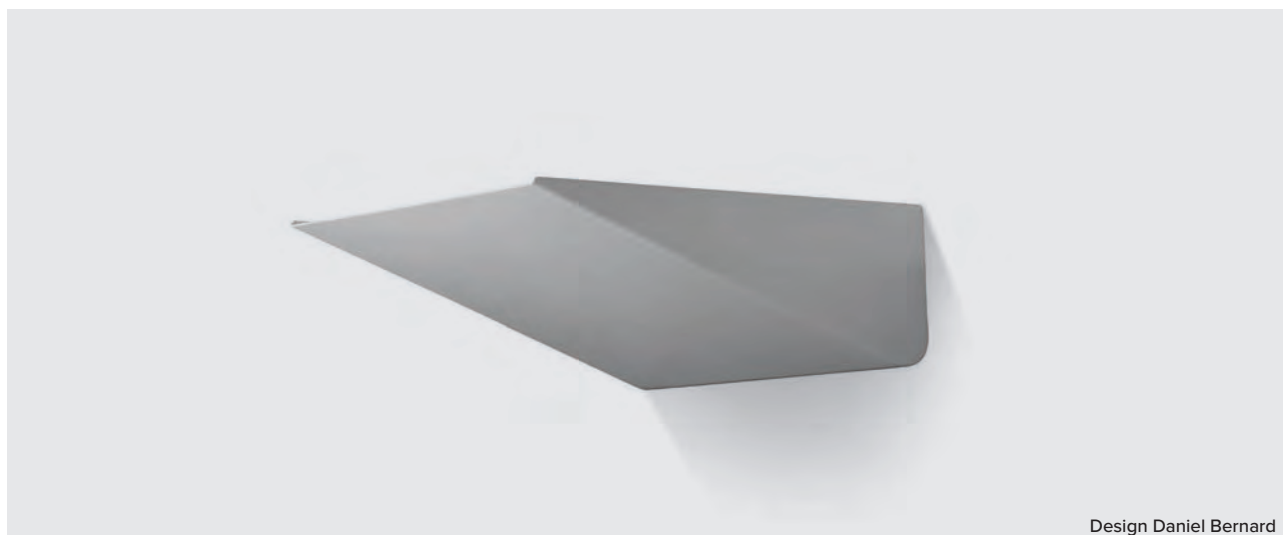

Design Daniel Bernard

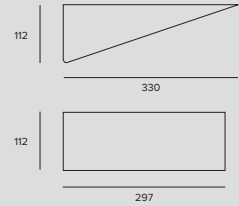
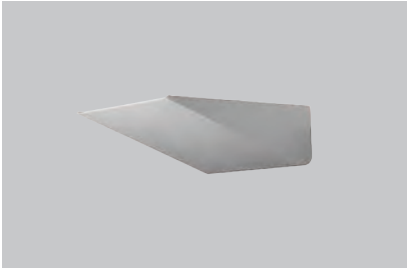

LED / 36W / ASYMMETRICAL ⊕ 3.6 IP20

	3000K	H(m)	D1(m)	D2(m)	E _{max} (lx)		
Ra80		121*	89*				
Fixture Power	40W	1	3.52	4.23	1670		
Source Flux	5160lm	2	7.03	8.46	418		
Fixture Flux	4453lm	3	10.55	12.69	186		
Efficacy	111lm/W	4	14.07	16.93	104		
TS892	I _{max} =487cd/klm	I _{max}	2511cd	5	17.59	21.16	67

Driver	Colour	3000K
DALI		1T4499
DALI		1T4506
DALI		1T4507
CASAMBI		1T4499CA

Accessories

Control systems

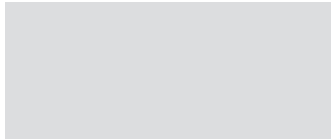

Code

1T5349

Wireless control unit for DALI fixtures.
 It generates a local DALI bus that can control individual fixtures.
 The module can be connected to an existing DALI network.
 The module is wireless controlled using a Casambi app for smartphones and tablets using Bluetooth 4.0 technology.
 The devices create a wireless mesh network that can control up to 128 fixtures.
 IP20.

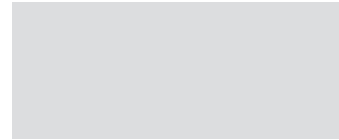

Code

1T5352

IP20 Extender for wireless control of DALI fixtures.
 It generates a local DALI bus with the capacity to drive up to 64 fixtures.
 Can control DALI fixtures in indoor applications.
 It is also equipped with a relay that can control non-dimmable fixtures up to a maximum of 6A.

SLIM

Wall mounted

GENERAL INFO

Indirect or direct/indirect modular wall mounted luminaire for LED sources.

638x26x80

1238x26x80

LED

Linear LED boards Low Power High efficiency

From 1720lm to 6880lm

3000K

Ra84

PRODUCT EFFICACY

Up to 112lm/W

OPTICS

VWFL

POWER SUPPLY

Electronic

MATERIAL

Body made of extruded anodised aluminium.

Polycarbonate lateral end caps. Lower diffusive

screen made of ribbed, extruded opal polycarbonate.

Transparent polycarbonate upper safety screen.

Compact size minimal modular applique with indirect/direct light emission that disappears into its surroundings leaving space for the architecture and light only.

Also available in a modular system suspension version or stand-alone, as well as a rectangular version that is particularly suitable for lighting open spaces in the office environment. Coordinates with the indirect or direct/indirect light emission wall mounted solution.

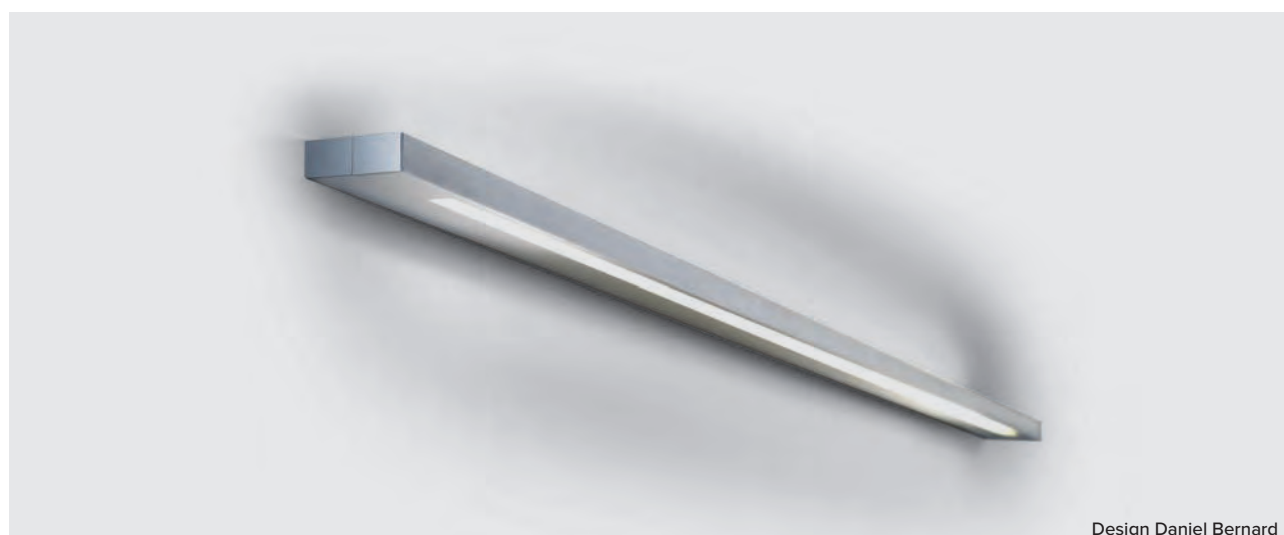

Design Daniel Bernard



Wall L. 638mm

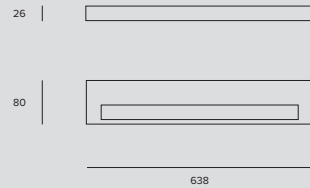

LED / 12W / INDIRECT / VWFL ± 1.8 IP20

		3000K	H(m)	D(m)	Emax(lx)	
		Ra84		115°		
Fixture Power	14W	1	3.13	546		
Source Flux	1720lm	2	6.26	137		
Fixture Flux	1562lm	3	9.39	61		
Efficacy	112lm/W	4	12.52	34		
TS751	Imax=318cd/klm	Imax	547cd	5	15.65	22

Driver	Colour	3000K
EL.	●	1T4192

LED / 24W / DIRECT/INDIRECT / VWFL ± 1.8 IP20

		3000K	H(m)	D(m)	Emax(lx)	
		Ra84		95°		
Fixture Power	28W	1	2.19	501		
Source Flux	3440lm	2	4.37	125		
Fixture Flux	2567lm	3	6.56	56		
Efficacy	92lm/W	4	8.75	31		
TS752	Imax=147cd/klm	Imax	505cd	5	10.93	20

Driver	Colour	3000K
EL.	●	1T4193



Wall L. 1238mm

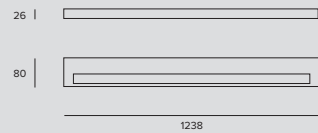

LED / 24W / INDIRECT / VWFL ± 3.7 IP20

		3000K	H(m)	D(m)	Emax(lx)	
		Ra84		115°		
Fixture Power	28W	1	3.13	1092		
Source Flux	3440lm	2	6.26	273		
Fixture Flux	3125lm	3	9.39	121		
Efficacy	112lm/W	4	12.52	68		
TS751	Imax=318cd/klm	Imax	1095cd	5	15.65	44

Driver	Colour	3000K
EL.	●	1T4194

LED / 48W / DIRECT/INDIRECT / VWFL ± 3.7 IP20

		3000K	H(m)	D(m)	Emax(lx)	
		Ra84		95°		
Fixture Power	56W	1	2.19	1002		
Source Flux	6880lm	2	4.37	250		
Fixture Flux	5133lm	3	6.56	111		
Efficacy	92lm/W	4	8.75	63		
TS752	Imax=147cd/klm	Imax	1009cd	5	10.93	40

Driver	Colour	3000K
EL.	●	1T4195

MINIMINIMA

Wall mounted

GENERAL INFO

Wall mounted fixture for LED sources with indirect or direct/indirect light emission.
600x50x32mm

LED

Linear Board LED Low Power High Efficiency

1720lm

3000K

Ra80

Ra90 - To order this version it is necessary to add the suffix "90" at the end of the standard code.

PRODUCT EFFICACY

Up to 60lm/W

OPTICS

VWFL

POWER SUPPLY

Electronic

MATERIAL

Body made of chromed or painted aluminium with opal polycarbonate diffuser.

A unique, thin linear element designed to remove sharp edges without connecting elements and any visible fastening system.

Available in different types to meet different needs: only indirect or combined direct/indirect light emission.

Available in ceiling mounted and suspensions versions.

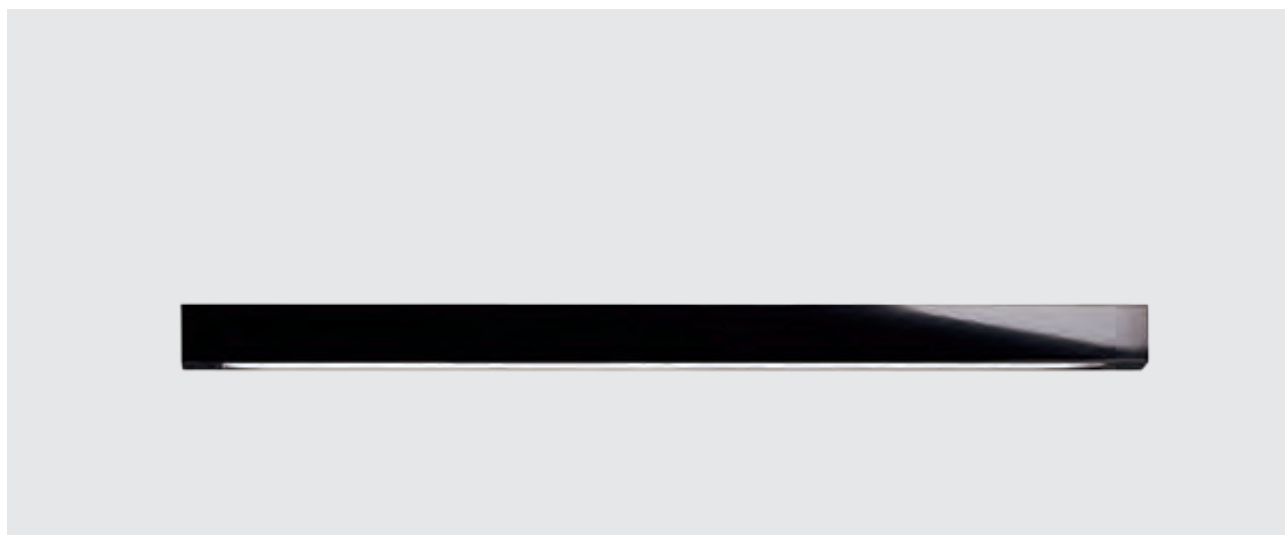



Wall

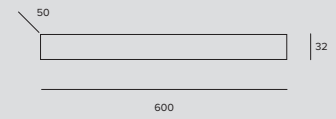

LED / 12W / INDIRECT / VWFL



		3000K	H(m)	D(m)	E _{max} (lx)	
		Ra80		111*		
Fixture Power	14W	1	2.89	321		
Source Flux	1720lm	2	5.79	80		
Fixture Flux	842lm	3	8.68	36		
Efficacy	60lm/W	4	11.58	20		
TS749	I _{max} =187cd/klm	I _{max}	321cd	5	14.47	13

Driver	Colour	3000K
EL.		1T4170
EL.		1T4171
EL.		1T4172
EL.		1T4173

LED / 12W / DIRECT/INDIRECT / VWFL



		3000K	H(m)	D(m)	E _{max} (lx)	
		Ra80		114*		
Fixture Power	14W	1	3.08	185		
Source Flux	1720lm	2	6.15	46		
Fixture Flux	1071lm	3	9.23	21		
Efficacy	76lm/W	4	12.31	12		
TS750	I _{max} =112cd/klm	I _{max}	192cd	5	15.38	7

Driver	Colour	3000K
EL.		1T4174
EL.		1T4175
EL.		1T4176
EL.		1T4177

MONETA

Wall mounted

GENERAL INFO

Wall mounted mono-emission LED fixture.
Ø140mm

LED

LED module 230V
825lm
3000K
Ra90

PRODUCT EFFICACY

46lm/W

OPTICS

VWFL

POWER SUPPLY

No driver necessary
Casambi control system available by using a dedicated
accessory (230Vac LED module max 150W).

MATERIAL

Matt painted aluminium body complete with opaline
polycarbonate diffuser.

A range of products with three different versions for three different installation types: ceiling mounted, suspension and wall mounted.

Just over 3cm thick to exploit the potential of the LED lamp to the full; compact size, excellent performance, low consumption and no driver make this a product where aesthetics and technology combine.





Wall

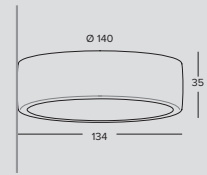

LED / 17W / VWFL



	3000K	H(m)	D(m)	E _{max} (lx)		
Ra90			114*			
Fixture Power	17W	1	3.07	303		
Source Flux	871lm	2	6.13	76		
Fixture Flux	871lm	3	9.20	34		
Efficacy	51lm/W	4	12.26	19		
T5771	Imax=348cd/klm	Imax	303cd	5	15.33	12

Power supply Colour 3000K

220-240Vac ○ 1T3771

220-240Vac ● 1T3772

Accessories

Control systems



Code

1T5351

A Wireless Trailing Edge / IGBT dimmer managed using Bluetooth 4.0 technology. It works with LED 230V-AC modules, dimmable LED sources and halogen lamps. It can be installed inside a standard 503 wall switch box, lighting fixtures or ceiling canopies.

It can manage systems with a maximum absorption of 150W.

The module is wireless controlled using a Casambi app for smartphones and tablets or traditional wall switches.

IP20

BRAQUE

GENERAL INFO

Indirect emission wall mounted LED fixture.

200x79x29mm

65x200x29mm

LED

LED module 230V

893lm

3000K

Ra80

PRODUCT EFFICACY

65lm/W

OPTICS

VWFL

POWER SUPPLY

No driver necessary

Casambi control system available by using a dedicated accessory (230Vac LED module max 150W).

MATERIAL

Matt painted aluminium body. Transparent polycarbonate screen.

Metal applique with sharp edges with mains voltage LED lamps. The special type of machining of the piece hollowed out from a solid provides perfect edges without visible joints or screws.

Available in two different sizes and two different installation types.

It doesn't need to the driver.



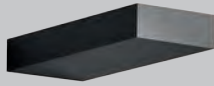

Vertical

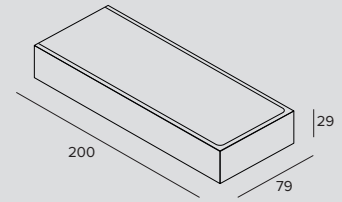

LED / 13W / VWFL



		3000K	H(m)	D1(m)	D2(m)	E _{max} (lx)
Ra80				110°	108°	
Fixture Power	14W	1	2.86	2.73	348	
Source Flux	893lm	2	5.72	5.46	87	
Fixture Flux	893lm	3	8.58	8.18	39	
Efficacy	65lm/W	4	11.44	10.91	22	
TS770	I _{max} =389cd/klm I _{max}	348cd	5	14.29	13.64	14

Colour 3000K

○ 1T3762

● 1T3763

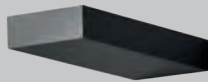

Horizontal

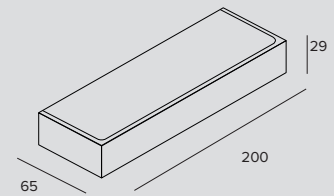

LED / 13W / VWFL



		3000K	H(m)	D1(m)	D2(m)	E _{max} (lx)
Ra80				110°	108°	
Fixture Power	14W	1	2.86	2.73	348	
Source Flux	893lm	2	5.72	5.46	87	
Fixture Flux	893lm	3	8.58	8.18	39	
Efficacy	65lm/W	4	11.44	10.91	22	
TS770	I _{max} =389cd/klm I _{max}	348cd	5	14.29	13.64	14

Colour 3000K

○ 1T3759

● 1T3760

Accessories

Control systems



Code

1T5351

A Wireless Trailing Edge / IGBT dimmer managed using Bluetooth 4.0 technology. It works with LED 230V-AC modules, dimmable LED sources and halogen lamps. It can be installed inside a standard 503 wall switch box, lighting fixtures or ceiling canopies.

It can manage systems with a maximum absorption of 150W.

The module is wireless controlled using a Casambi app for smartphones and tablets or traditional wall switches.

IP20

BOTTONE

GENERAL INFO

Wall mounted or ceiling mounted LED fixture.
Ø400mm – Ø320mm – Ø260mm

LED

Ø260mm version
LED module 230V
554lm
3000K
Ra80

Ø400mm – Ø320mm
Circular LED board
From 818lm to 826lm
3000K
Ra80

PRODUCT EFFICACY

Up to 83lm/W

OPTICS

VWFL

POWER SUPPLY

Electronic
Casambi control system available by using a dedicated
accessory (230Vac LED module max 150W).

MATERIAL

Diffuser in glazed opal glass.
White painted metal mounting plate.

A LED solution for functional yet decorative lighting at the same time.

The combination of mains voltage LED lamps combined with the excellent diffusion of the opal glass, ensures a soft and enveloping emission.





Ø 260mm

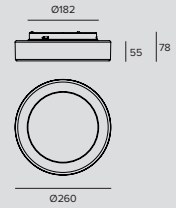

LED / 14W / VWFL



		3000K	H(m)	D(m)	E _{max} (lx)
		Ra84		132°	
Fixture Power	14W	1	4.47	120	
Source Flux	554lm	2	8.95	30	
Fixture Flux	554lm	3	13.42	13	
Efficacy	40lm/W	4	17.89	8	
TS797	I _{max} =217cd/klm	I _{max}	120cd	5	22.37

Colour 3000K

● 1T3997



Ø 320mm

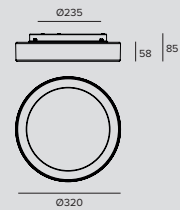

LED / 8W / VWFL



		3000K	H(m)	D(m)	E _{max} (lx)
		Ra84		129°	
Fixture Power	10W	1	4.22	186	
Source Flux	826lm	2	8.43	47	
Fixture Flux	826lm	3	12.65	21	
Efficacy	83lm/W	4	16.86	12	
TS796	I _{max} =226cd/klm	I _{max}	186cd	5	21.08

Driver Colour 3000K

EL. ● 1T3998



Ø 400mm

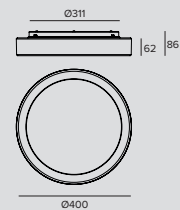

LED / 8W / VWFL



		3000K	H(m)	D(m)	E _{max} (lx)
		Ra84		125°	
Fixture Power	10W	1	3.82	204	
Source Flux	818lm	2	7.64	51	
Fixture Flux	818lm	3	11.45	23	
Efficacy	82lm/W	4	15.27	13	
TS795	I _{max} =250cd/klm	I _{max}	204cd	5	19.09

Driver Colour 3000K

EL. ● 1T3999

OSIRIDE

GENERAL INFO

Wall or ceiling mounted fixture for halogen or compact fluorescent lamps or LED version.

Ø200mm – Ø260mm

Ø320mm – Ø400mm – Ø500mm

LED

LED VERSION

Ø260mm

230V LED module

Ø320MM – Ø400MM

Circular boards

From 619lm to 993m

3000K

Ra84

PRODUCT EFFICACY

LED VERSION

Up to 99lm/W

OPTICS

VWFL

POWER SUPPLY

Electronic

Casambi control system available by using a dedicated accessory (230Vac LED module max 150W).

MATERIAL

White painted metal body and satin opaline white glass diffuser.

A range of ceiling/wall mounted fixtures in satin opaline white glass. Two different versions: simple with a white frame or more sophisticated with a chrome frame.

Five different sizes that can be equipped with halogen lamps, compact fluorescent lamps or LED lamps with E27 adapters not included or a 230V LED version with the LED lamp included.





Ø 200mm

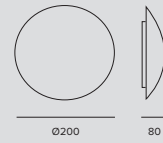

Power supply	Colour	Code
220-240Vac		323494IP



Ø 260mm

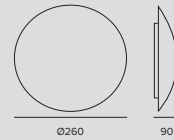

Power supply	Colour	Code
220-240Vac		323404IP



Ø 320mm

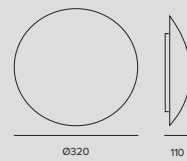

Power supply	Colour	Code
220-240Vac		323414IP

OSIRIDE



Ø 400mm

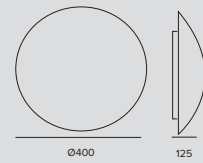

E27 FLUO/HAL/LED / max 2x42W □ 3.7 IP44

Power supply	Colour	Code
220-240Vac	●	323424IP

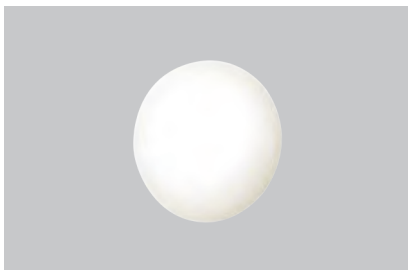

Ø 500mm

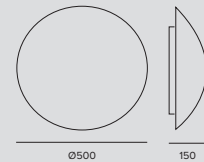

E27 FLUO/HAL/LED / max 2x42W □ 4.6 IP44

Power supply	Colour	Code
220-240Vac	●	323434IP



LED Ø 260mm

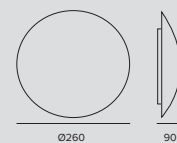

LED / 14W / VWFL ± 1.5 IP44

		3000K	H(m)	D(m)	E _{max} (lx)
		Ra84		121*	
Fixture Power	14W	1	3.56	164	
Source Flux	619lm	2	7.12	41	
Fixture Flux	619lm	3	10.68	18	
Efficacy	45lm/W	4	14.25	10	
TS801	I _{max} =265cd/klm	I _{max}	164cd	5	17.81
				7	

Power supply	Colour	3000K
220-240Vac	●	1T4002



LED Ø 320mm

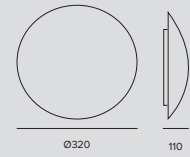

LED / 8W / VWFL



		3000K	H(m)	D(m)	Emax(lx)
		Ra84		121°	
Fixture Power	10W	1	3.56	263	
Source Flux	993lm	2	7.12	66	
Fixture Flux	993lm	3	10.68	29	
Efficacy	99lm/W	4	14.25	16	
TS801	Imax=265cd/klm Imax	263cd	5	17.81	11

Driver	Colour	3000K
EL.		1T4003



LED Ø 400mm

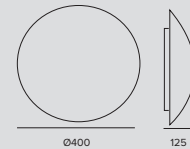

LED / 8W / VWFL



		3000K	H(m)	D(m)	Emax(lx)
		Ra84		121°	
Fixture Power	10W	1	3.56	236	
Source Flux	892lm	2	7.12	59	
Fixture Flux	892lm	3	10.68	26	
Efficacy	89lm/W	4	14.25	15	
TS801	Imax=265cd/klm Imax	236cd	5	17.81	9

Driver	Colour	3000K
EL.		1T4004

Accessories

Mounting System



Code

323900

Support for semi-recessed installation.
 D=200mm cutout hole 147mm.
 D=260mm cutout hole 193mm.
 D=320mm cutout hole 244mm.
 D=400mm cutout hole 322mm.
 D=500mm cutout hole 368mm.

Control systems



Code

1T5351

A Wireless Trailing Edge / IGBT dimmer managed using Bluetooth 4.0 technology. It works with LED 230V-AC modules, dimmable LED sources and halogen lamps. It can be installed inside a standard 503 wall switch box, lighting fixtures or ceiling canopies. It can manage systems with a maximum absorption of 150W. The module is wireless controlled using a Casambi app for smartphones and tablets or traditional wall switches. IP20

OSIRIDE



Chrome Frame Ø 205mm

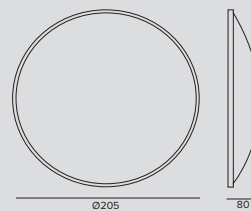

E27 HAL/LED / max 1x42W



Power supply	Colour	Code
220-240Vac	 	349490IP



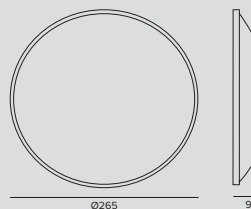

Chrome Frame Ø 265mm



E27 FLUO/HAL/LED / max 1x42W



Power supply	Colour	Code
220-240Vac	 	349400IP



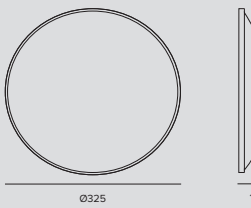

Chrome Frame Ø 325mm

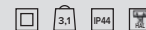

E27 FLUO/HAL/LED / max 2x42W



Power supply	Colour	Code
220-240Vac	 	349410IP



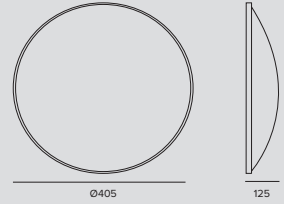

Chrome Frame Ø 405mm



E27 FLUO/HAL/LED / max 2x42W



Power supply	Colour	Code
220-240Vac	 	349420IP



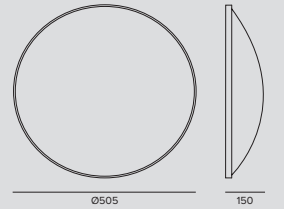

Chrome Frame Ø 505mm



E27 FLUO/HAL/LED / max 2x42W



Power supply	Colour	Code
220-240Vac	 	349430IP

PROFESSIONAL

GENERAL INFO

Wall or ceiling mounted fixture for LED, halogen or compact fluorescent lamps or LED 230V integrated version.

120x220mm

235x235mm

275x275mm

350x350mm

LED

LED VERSION 235x235

230V Module

LED VERSION 275x275mm

Circular boards

From 722lm to 936lm

3000K

Ra84

LAMPS

HAL – FLUO – LED 2xmax42W

TC-DEL 2x18W

Not included

PRODUCT EFFICACY

94lm/W

OPTICS

VWFL

POWER SUPPLY

Electronic

Casambi control system available by using a dedicated accessory (230Vac LED module max 150W).

MATERIAL

White painted metal body and satin opaline white glass diffuser.

White painted metal fixing plate.

A wall or ceiling mounted fixture with a glazed glass diffuser for soft general lighting.

Available in four different sizes fitted with traditional LED lamps with E27 adapters or compact fluorescent lamps not included.

Available also in a LED 230V version.





120x220mm

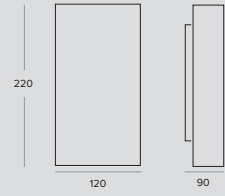

Power supply	Colour	Code
220-240Vac		374604IP



235x235mm

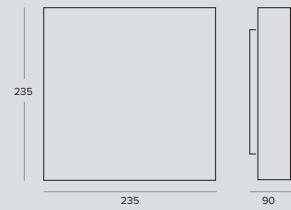

Power supply	Colour	Code
220-240Vac		374404IP



Power supply	Colour	Code
220-240Vac		374404E

PROFESSIONAL



275x275mm

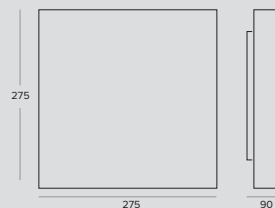

E27 FLUO/HAL/LED / max 2x42W

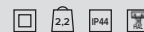

Driver	Colour	Code
		374414IP

TC-DEL / 2x18W G24q-2



Driver	Colour	Code
EL.		374414E



350x350mm

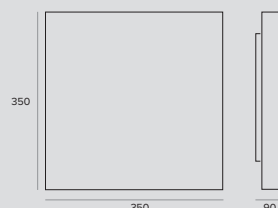

E27 FLUO/HAL/LED / max 3x42W

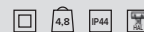

Power supply	Colour	Code
220-240Vac		374424IP

TC-TEL / 2x42W Gx24q-4



Driver	Colour	Code
EL.		374424E



LED 235x235mm

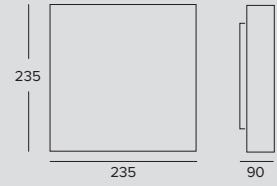

LED / 14W / VWFL



		3000K	H(m)	D(m)	E _{max} (lx)	
		Ra84		135°		
Fixture Power	14W	1	4.86	142		
Source Flux	722lm	2	9.72	36		
Fixture Flux	722lm	3	14.58	16		
Efficacy	52lm/W	4	19.44	9		
TS802	I _{max} =197cd/klm	I _{max}	143cd	5	24.30	6

Driver	Colour	3000K
		1T4005



LED 275x275mm

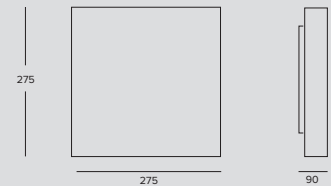

LED / 8W / VWFL



		3000K	H(m)	D(m)	E _{max} (lx)	
		Ra84		135°		
Fixture Power	10W	1	4.86	184		
Source Flux	936lm	2	9.72	46		
Fixture Flux	936lm	3	14.58	20		
Efficacy	94lm/W	4	19.44	12		
TS802	I _{max} =197cd/klm	I _{max}	185cd	5	24.30	7

Driver	Colour	3000K
EL.		1T4006

Accessories

Control systems



Code

1T5351

A Wireless Trailing Edge / IGBT dimmer managed using Bluetooth 4.0 technology. It works with LED 230V-AC modules, dimmable LED sources and halogen lamps. It can be installed inside a standard 503 wall switch box, lighting fixtures or ceiling canopies.

It can manage systems with a maximum absorption of 150W.

The module is wireless controlled using a Casambi app for smartphones and tablets or traditional wall switches.

IP20

Outdoor

Inground recessed

Linear inground recessed

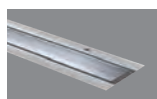

544
JEDI

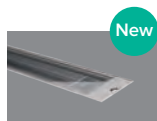

556
JEDI COMPACT

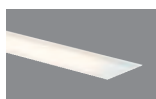

570
MERCURE



574
MINIMERCURE



577
MICROMERCURE

Inground recessed

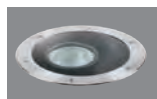

578
KEPLERO



593
KEPLERO MINI

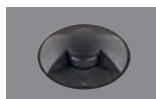

602
TITANO



604
JUPITER



614
SATURN



620
LED.Y

JEDI

Recessed

GENERAL INFO

Recessed linear projector.
Lengths 616mm – 916mm – 1216mm

LED

Optics FL, GR, WW - Linear boards
Optic SP - Led Emitter
RGBW version - Led Emitter
From 632lm to 7180m
3000K – 4000K – RGBW
Ra80

PRODUCT EFFICACY

Up to 113lm/W

OPTICS

SP – FL – GRAZING – WALL WASHER

POWER SUPPLY

Electronic – DALI
Casambi control: the DALI version is fitted with special accessories.

MATERIAL

Extruded anodised aluminium 15µ body. Extra clear 10mm thick glass flat screen. Brushed stainless steel (AISI 316) frame. The body of the fixture can resist a static load up to 20kN and vandalism (IK10). Anti-slip glass available on request.

A coordinated range of linear projectors for lighting large surfaces.

The multiplicity of effects, three different lengths with lumen packages proportioned to each one, maximum load and vandal resistance make it a flexible tool that can always provide solutions to various project needs in the public or private sector.

Completely sealed housing complete with external electrical connection through IP68 connectors.

Continuous line installation using accessories.

Available also in projector and RGBW versions.





5300 McConnell

Architect
Shubin+Donaldson
Architects

Lighting Design
Oculus Light Studio

Photographer
©Henri Khodaverdi

Country
Los Angeles, USA

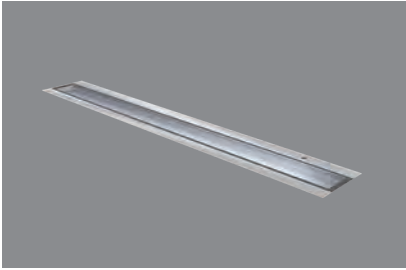

Recessed L. 616mm

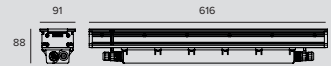

LED / 23W / SPOT

	3000K	H(m)	D(m)	E _{max} (lx)		
Ra80			10°			
Fixture Power	28W	1	0.18	32201		
Source Flux	1947lm	2	0.37	8050		
Fixture Flux	1591lm	3	0.55	3578		
Efficacy	57lm/W	4	0.73	2013		
TS889	I _{max} =16539cd/klm	I _{max}	32201cd	5	0.92	1288

Driver	Colour	3000K	4000K
EL.	●	1E2737	1E2738
DALI	●	1E2739	1E2740

LED / 12W / FLOOD

	3000K	H(m)	D1(m)	D2(m)	E _{max} (lx)		
Ra80			85°	32°			
Fixture Power	15W	1	1.84	0.57	1203		
Source Flux	1720lm	2	3.68	1.14	301		
Fixture Flux	1285lm	3	5.53	1.70	134		
Efficacy	86lm/W	4	7.37	2.27	75		
TS886	I _{max} =699cd/klm	I _{max}	1203cd	5	9.21	2.84	48

Driver	Colour	3000K	4000K
EL.	●	1E2689	1E2690
DALI	●	1E2691	1E2692

LED / 24W / FLOOD

	3000K	H(m)	D1(m)	D2(m)	E _{max} (lx)		
Ra80			85°	32°			
Fixture Power	28W	1	1.84	0.57	2392		
Source Flux	3420lm	2	3.68	1.14	598		
Fixture Flux	2555lm	3	5.53	1.70	266		
Efficacy	91lm/W	4	7.37	2.27	149		
TS885	I _{max} =699cd/klm	I _{max}	2392cd	5	9.21	2.84	96

Driver	Colour	3000K	4000K
EL.	●	1E2693	1E2694
DALI	●	1E2695	1E2696

LED / 12W / GRAZING

	3000K	H(m)	D1(m)	D2(m)	E _{max} (lx)		
Ra80			76°	15°			
Fixture Power	15W	1	1.55	0.26	2753		
Source Flux	1720lm	2	3.10	0.51	688		
Fixture Flux	1429lm	3	4.65	0.77	306		
Efficacy	95lm/W	4	6.20	1.02	172		
TS888	I _{max} =1601cd/klm	I _{max}	2753cd	5	7.76	1.28	110

Driver	Colour	3000K	4000K
EL.	●	1E2665	1E2666
DALI	●	1E2667	1E2668

LED / 24W / GRAZING

	3000K	H(m)	D1(m)	D2(m)	E _{max} (lx)		
Ra80			76°	15°			
Fixture Power	28W	1	1.55	0.26	5474		
Source Flux	3420lm	2	3.10	0.51	1368		
Fixture Flux	2842lm	3	4.65	0.77	608		
Efficacy	101lm/W	4	6.21	1.02	342		
TS887	I _{max} =1601cd/klm	I _{max}	5474cd	5	7.76	1.28	219

Driver	Colour	3000K	4000K
EL.	●	1E2669	1E2670
DALI	●	1E2671	1E2672

LED / 12W / WALL WASHER



		3000K	H(m)	D1(m)	D2(m)	E _{max} (lx)	
Ra80				115°	59°		
Fixture Power	15W	1	3.12	1.34	1156		
Source Flux	1720lm	2	6.23	2.67	289		
Fixture Flux	1293lm	3	9.35	4.01	128		
Efficacy	86lm/W	4	12.47	5.35	72		
TS884	I _{max} =774cd/klm	I _{max}	1331cd	5	15.58	6.69	46

Driver	Colour	3000K	4000K
EL.	●	1E2713	1E2714
DALI	●	1E2715	1E2716

LED / 24W / WALL WASHER



		3000K	H(m)	D1(m)	D2(m)	E _{max} (lx)	
Ra80				115°	59°		
Fixture Power	28W	1	3.12	1.34	2299		
Source Flux	3420lm	2	6.23	2.67	575		
Fixture Flux	2572lm	3	9.35	4.01	255		
Efficacy	92lm/W	4	12.47	5.35	144		
TS883	I _{max} =774cd/klm	I _{max}	2646cd	5	15.59	6.69	92

Driver	Colour	3000K	4000K
EL.	●	1E2717	1E2718
DALI	●	1E2719	1E2720

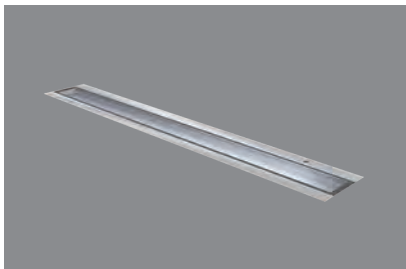

Recessed L. 916mm



LED / 34W / SPOT



		3000K	H(m)	D(m)	E _{max} (lx)	
Ra80				10°		
Fixture Power	40W	1	0.18	48326		
Source Flux	2922lm	2	0.37	12081		
Fixture Flux	2387lm	3	0.55	5370		
Efficacy	60lm/W	4	0.73	3020		
TS889	I _{max} =16539cd/klm	I _{max}	48326cd	5	0.92	1933

Driver	Colour	3000K	4000K
EL.	●	1E2741	1E2742
DALI	●	1E2743	1E2744

LED / 18W / FLOOD



		3000K	H(m)	D1(m)	D2(m)	E _{max} (lx)	
Ra80				85°	32°		
Fixture Power	22W	1	1.84	0.57	1804		
Source Flux	2580lm	2	3.68	1.14	451		
Fixture Flux	1927lm	3	5.53	1.70	200		
Efficacy	88lm/W	4	7.37	2.27	113		
TS886	I _{max} =699cd/klm	I _{max}	1804cd	5	9.21	2.84	72

Driver	Colour	3000K	4000K
EL.	●	1E2697	1E2698
DALI	●	1E2699	1E2700

LED / 36W / FLOOD



		3000K	H(m)	D1(m)	D2(m)	E _{max} (lx)	
Ra80				85°	32°		
Fixture Power	40W	1	1.84	0.57	3588		
Source Flux	5130lm	2	3.68	1.14	897		
Fixture Flux	3833lm	3	5.53	1.70	399		
Efficacy	96lm/W	4	7.37	2.27	224		
TS885	I _{max} =699cd/klm	I _{max}	3588cd	5	9.21	2.84	144

Driver	Colour	3000K	4000K
EL.	●	1E2701	1E2702
DALI	●	1E2703	1E2704

LED / 18W / GRAZING



		3000K	H(m)	D1(m)	D2(m)	E _{max} (lx)	
Ra80			76°	15°			
Fixture Power	22W	1	1.55	0.26	4130		
Source Flux	2580lm	2	3.10	0.51	1032		
Fixture Flux	2144lm	3	4.65	0.77	459		
Efficacy	97lm/W	4	6.20	1.02	258		
TS888	I _{max} =1601cd/klm	I _{max}	4130cd	5	7.76	1.28	165

Driver	Colour	3000K	4000K
EL.		1E2673	1E2674
DALI		1E2675	1E2676

LED / 36W / GRAZING



		3000K	H(m)	D1(m)	D2(m)	E _{max} (lx)	
Ra80			76°	15°			
Fixture Power	40W	1	1.55	0.26	8211		
Source Flux	5130lm	2	3.10	0.51	2053		
Fixture Flux	4263lm	3	4.65	0.77	912		
Efficacy	107lm/W	4	6.21	1.02	513		
TS887	I _{max} =1601cd/klm	I _{max}	8211cd	5	7.76	1.28	328

Driver	Colour	3000K	4000K
EL.		1E2677	1E2678
DALI		1E2679	1E2680

LED / 18W / WALL WASHER



		3000K	H(m)	D1(m)	D2(m)	E _{max} (lx)	
Ra80			115°	59°			
Fixture Power	22W	1	3.12	1.34	1735		
Source Flux	2580lm	2	6.23	2.67	434		
Fixture Flux	1940lm	3	9.35	4.01	193		
Efficacy	88lm/W	4	12.47	5.35	108		
TS884	I _{max} =774cd/klm	I _{max}	1996cd	5	15.58	6.69	69

Driver	Colour	3000K	4000K
EL.		1E2721	1E2722
DALI		1E2723	1E2724

LED / 36W / WALL WASHER



		3000K	H(m)	D1(m)	D2(m)	E _{max} (lx)	
Ra80			115°	59°			
Fixture Power	40W	1	3.12	1.34	3449		
Source Flux	5130lm	2	6.23	2.67	862		
Fixture Flux	3858lm	3	9.35	4.01	383		
Efficacy	96lm/W	4	12.47	5.35	216		
TS883	I _{max} =774cd/klm	I _{max}	3969cd	5	15.59	6.69	138

Driver	Colour	3000K	4000K
EL.		1E2725	1E2726
DALI		1E2727	1E2728

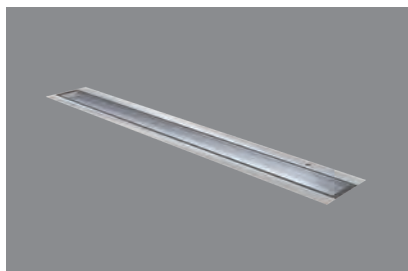

Recessed L. 1216mm

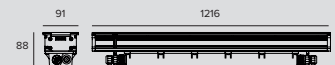

LED / 46W / SPOT



		3000K	H(m)	D(m)	E _{max} (lx)	
Ra80				10°		
Fixture Power	51W	1	0.18	64401		
Source Flux	3894lm	2	0.37	16100		
Fixture Flux	3181lm	3	0.55	7156		
Efficacy	62lm/W	4	0.73	4025		
TS889	I _{max} =16539cd/klm	I _{max}	64401cd	5	0.92	2576

Driver	Colour	3000K	4000K
EL.		1E2745	1E2746
DALI		1E2747	1E2748

LED / 24W / FLOOD



		3000K	H(m)	D1(m)	D2(m)	E _{max} (lx)	
		Ra80		85°	32°		
Fixture Power	28W	1	1.84	0.57	2405		
Source Flux	3440lm	2	3.68	1.14	601		
Fixture Flux	2570lm	3	5.53	1.70	267		
Efficacy	92lm/W	4	7.37	2.27	150		
TS886	I _{max} =699cd/klm	I _{max}	2405cd	5	9.21	2.84	96

Driver	Colour	3000K	4000K
EL.		1E2705	1E2706
DALI		1E2707	1E2708

LED / 48W / FLOOD



		3000K	H(m)	D1(m)	D2(m)	E _{max} (lx)	
		Ra80		85°	32°		
Fixture Power	53W	1	1.84	0.57	4784		
Source Flux	6840lm	2	3.68	1.14	1196		
Fixture Flux	5111lm	3	5.53	1.70	532		
Efficacy	96lm/W	4	7.37	2.27	299		
TS885	I _{max} =699cd/klm	I _{max}	4784cd	5	9.21	2.84	191

Driver	Colour	3000K	4000K
EL.		1E2709	1E2710
DALI		1E2711	1E2712

LED / 24W / GRAZING



		3000K	H(m)	D1(m)	D2(m)	E _{max} (lx)	
		Ra80		76°	15°		
Fixture Power	28W	1	1.55	0.26	5506		
Source Flux	3440lm	2	3.10	0.51	1377		
Fixture Flux	2859lm	3	4.65	0.77	612		
Efficacy	102lm/W	4	6.20	1.02	344		
TS888	I _{max} =1601cd/klm	I _{max}	5506cd	5	7.76	1.28	220

Driver	Colour	3000K	4000K
EL.		1E2681	1E2682
DALI		1E2683	1E2684

LED / 48W / GRAZING



		3000K	H(m)	D1(m)	D2(m)	E _{max} (lx)	
		Ra80		76°	15°		
Fixture Power	53W	1	1.55	0.26	10948		
Source Flux	6840lm	2	3.10	0.51	2737		
Fixture Flux	5684lm	3	4.65	0.77	1216		
Efficacy	107lm/W	4	6.21	1.02	684		
TS887	I _{max} =1601cd/klm	I _{max}	10948cd	5	7.76	1.28	438

Driver	Colour	3000K	4000K
EL.		1E2685	1E2686
DALI		1E2687	1E2688

LED / 24W / WALL WASHER



		3000K	H(m)	D1(m)	D2(m)	E _{max} (lx)	
		Ra80		115°	59°		
Fixture Power	28W	1	3.12	1.34	2313		
Source Flux	3440lm	2	6.23	2.67	578		
Fixture Flux	2587lm	3	9.35	4.01	257		
Efficacy	92lm/W	4	12.47	5.35	145		
TS884	I _{max} =774cd/klm	I _{max}	2662cd	5	15.58	6.69	93

Driver	Colour	3000K	4000K
EL.		1E2729	1E2730
DALI		1E2731	1E2732

LED / 48W / WALL WASHER



		3000K	H(m)	D1(m)	D2(m)	E _{max} (lx)	
		Ra80		115°	59°		
Fixture Power	53W	1	3.12	1.34	4599		
Source Flux	6840lm	2	6.23	2.67	1150		
Fixture Flux	5144lm	3	9.35	4.01	511		
Efficacy	97lm/W	4	12.47	5.35	287		
TS883	I _{max} =774cd/klm	I _{max}	5293cd	5	15.59	6.69	184

Driver	Colour	3000K	4000K
EL.		1E2733	1E2734
DALI		1E2735	1E2736

JEDI

Related codes

Insertion Box	
	
L	Code
618	1E3507
918	1E3508
1218	1E3509

Insertion boxes.

Accessories

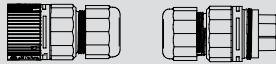
Connector	
	
Code	
	1E2769

Connectors kit for 5 pole coaxial connections.

Tool	
	
Code	
	1E2495

Features TORX HEAD, TX 30.

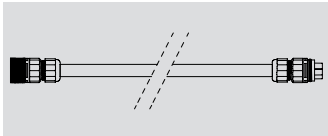
Cable	
	
L	Code
320	1E2762
470	1E2763
620	1E2764
770	1E2765

Connection cable.
Complete with 5 pole connectors.
For the electronic and DALI version.

1E2762
For in line adjacent connection of one 600mm projector with one 900mm projector.

1E2763
For in line adjacent connection of one 600mm projector with one 1200mm projector or two 900mm projectors.

1E2764
For in line adjacent connection of one 900mm projector with one 1200mm projector.

1E2765
For in line adjacent connection of two 1200mm projectors.

Control systems	
	
Code	
	1E3048
	
Code	
	1E3049

A IP67 Module for individual control of external devices equipped with DALI drivers. The module needs to be positioned in order to receive radio signals. The distance to the lighting fixtures can reach up to 50m.

IP67 Extender for wireless control of DALI fixtures. It generates a local DALI bus with the capacity to drive up to 64 fixtures. Can control DALI fixtures in outdoor applications.

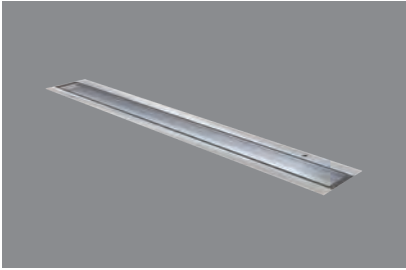

Recessed RGBW L. 616mm



LED RGBW / 17W 4Ch / SPOT

	H(m)	D(m)	E _{max} (lx)
		11°	
Fixture Power	9W	1	0.19 2101
Source Flux	121lm	2	0.38 525
Fixture Flux	121lm	3	0.56 233
Efficacy	13lm/W	4	0.75 131
TS1030	Imax=17366cd/klm	Imax	2101cd 5 0.94 84

Driver	Colour	Code
EL. DMX		1E3100

LED RGBW / 17W 4Ch / FLOOD

	H(m)	D1(m)	D2(m)	E _{max} (lx)
		85°	29°	
Fixture Power	9W	1	1.82 0.52 91	
Source Flux	88lm	2	3.65 1.04 23	
Fixture Flux	88lm	3	5.47 1.56 10	
Efficacy	10lm/W	4	7.29 2.08 6	
TS1033	Imax=1038cd/klm	Imax	91cd 5 9.11 2.60 4	

Driver	Colour	Code
EL. DMX		1E3101

LED RGBW / 17W 4Ch / GRAZING

	H(m)	D1(m)	D2(m)	E _{max} (lx)
		73°	11°	
Fixture Power	9W	1	1.48 0.19 235	
Source Flux	105lm	2	2.97 0.38 59	
Fixture Flux	105lm	3	4.45 0.57 26	
Efficacy	12lm/W	4	5.94 0.76 15	
TS1029	Imax=2250cd/klm	Imax	235cd 5 7.42 0.96 9	

Driver	Colour	Code
EL. DMX		1E3099

LED RGBW / 17W 4Ch / WALL WASHER

	H(m)	D1(m)	D2(m)	E _{max} (lx)
		115°	55°	
Fixture Power	9W	1	3.17 1.18 95	
Source Flux	96lm	2	6.33 2.36 24	
Fixture Flux	96lm	3	9.50 3.55 11	
Efficacy	11lm/W	4	12.67 4.73 6	
TS1036	Imax=1163cd/klm	Imax	111cd 5 15.83 5.91 4	

Driver	Colour	Code
EL. DMX		1E3102

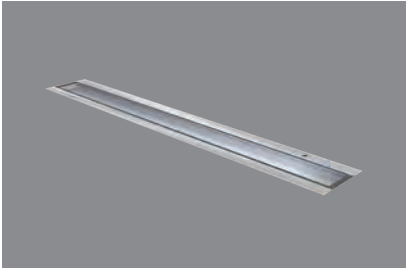

Recessed RGBW L. 916mm



LED RGBW / 26W 4Ch / SPOT



		H(m)	D(m)	E _{max} (lx)
			11°	
Fixture Power	15W	1	0.19	3152
Source Flux	182lm	2	0.38	788
Fixture Flux	181lm	3	0.56	350
Efficacy	12lm/W	4	0.75	197
TS1031	I _{max} =17366cd/klm	I _{max}	3152cd	0.94 126

Driver	Colour	Code
EL. DMX		1E3104

LED RGBW / 26W 4Ch / FLOOD



		H(m)	D1(m)	D2(m)	E _{max} (lx)
			85°	29°	
Fixture Power	15W	1	1.82	0.52	136
Source Flux	131lm	2	3.65	1.04	34
Fixture Flux	131lm	3	5.47	1.56	15
Efficacy	9lm/W	4	7.29	2.08	9
TS1034	I _{max} =1038cd/klm	I _{max}	136cd	5 9.11 2.60	5

Driver	Colour	Code
EL. DMX		1E3105

LED RGBW / 26W 4Ch / GRAZING



		H(m)	D1(m)	D2(m)	E _{max} (lx)
			73°	11°	
Fixture Power	15W	1	1.48	0.19	353
Source Flux	157lm	2	2.97	0.38	88
Fixture Flux	157lm	3	4.45	0.57	39
Efficacy	10lm/W	4	5.94	0.76	22
TS1028	I _{max} =2250cd/klm	I _{max}	353cd	5 7.42 0.96	14

Driver	Colour	Code
EL. DMX		1E3103

LED RGBW / 26W 4Ch / WALL WASHER



		H(m)	D1(m)	D2(m)	E _{max} (lx)
			115°	55°	
Fixture Power	15W	1	3.17	1.18	142
Source Flux	143lm	2	6.33	2.36	35
Fixture Flux	143lm	3	9.50	3.55	16
Efficacy	10lm/W	4	12.67	4.73	9
TS1037	I _{max} =1163cd/klm	I _{max}	167cd	5 15.83 5.91	6

Driver	Colour	Code
EL. DMX		1E3106

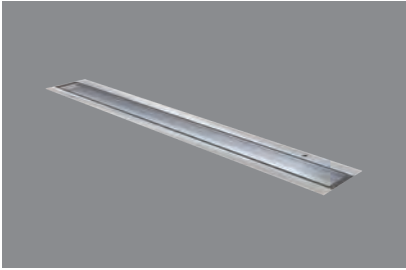

Recessed RGBW L. 1216mm

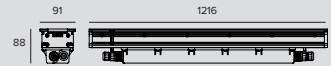

LED RGBW / 34W 4Ch / SPOT



		H(m)	D(m)	E _{max} (lx)
			11°	
Fixture Power	18W	1	0.19	4203
Source Flux	242lm	2	0.38	1051
Fixture Flux	242lm	3	0.56	467
Efficacy	13lm/W	4	0.75	263
TS1032	I _{max} =17366cd/klm	I _{max}	4203cd	5 0.94 168

Driver	Colour	Code
EL. DMX	●	1E3108

LED RGBW / 34W 4Ch / FLOOD



		H(m)	D1(m)	D2(m)	E _{max} (lx)
			85°	29°	
Fixture Power	18W	1	1.82	0.52	182
Source Flux	175lm	2	3.65	1.04	45
Fixture Flux	175lm	3	5.47	1.56	20
Efficacy	10lm/W	4	7.29	2.08	11
TS1035	I _{max} =1038cd/klm	I _{max}	182cd	5 9.11 2.60 7	

Driver	Colour	Code
EL. DMX	●	1E3109

LED RGBW / 34W 4Ch / GRAZING



		H(m)	D1(m)	D2(m)	E _{max} (lx)
			73°	11°	
Fixture Power	18W	1	1.48	0.19	471
Source Flux	209lm	2	2.97	0.38	118
Fixture Flux	209lm	3	4.45	0.57	52
Efficacy	12lm/W	4	5.94	0.76	29
TS1027	I _{max} =2250cd/klm	I _{max}	471cd	5 7.42 0.96 19	

Driver	Colour	Code
EL. DMX	●	1E3107

LED RGBW / 34W 4Ch / WALL WASHER



		H(m)	D1(m)	D2(m)	E _{max} (lx)
			115°	55°	
Fixture Power	18W	1	3.17	1.18	189
Source Flux	191lm	2	6.33	2.36	47
Fixture Flux	191lm	3	9.50	3.55	21
Efficacy	11lm/W	4	12.67	4.73	12
TS1038	I _{max} =1163cd/klm	I _{max}	222cd	5 15.83 5.91 8	

Driver	Colour	Code
EL. DMX	●	1E3110

Note

Photometrics show the maximum emission values of fixtures.

JEDI

Related codes

Insertion Box



L	Code
618	1E3507
918	1E3508
1218	1E3509

Insertion boxes.

Accessories

Tool



Code
1E2495

Features TORX HEAD, TX 30.

Connector



Code
1E2769

Connectors kit for 5 pole coaxial connections.



Code
1E3184

DMX connection.

Control systems



Code
1E2767

USB-RDM Programmer code.
DMX-RDM (Remote Device Management) address planner.
Used with the "RDM Targetti" software that can be downloaded for free from the Targetti website download section.
To be used with all RGBW products.



Seegerstrom center for the Arts

Lighting Design
HLB, Inc.

Photographer
©SAC Design

Country
Costa Mesa, USA

JEDI

Compact recessed

GENERAL INFO

Ground recessed linear projector
53x43mm (remote driver)
53x80mm (integrated driver)
Length 344mm – 625mm – 905mm – 1185mm

LED

Linear boards
From 1615 to 7200lm
2700K – 3000K – 3500K – 4000K
Ra84

PRODUCT EFFICACY

Up to 113lm/W

OPTICS

SP – FL – GRAZING – WALL WASHER

POWER SUPPLY

Electronic – DALI
Casambi control: DALI versions equipped with special accessories.

MATERIAL

Anodised extruded aluminium frame. Flat screen in extra-clear glass.

LED linear recessed line with high performance and compact dimensions. Available in a double version with remote driver at 344 mm and with integrated driver at 625 mm to be completed with the special recessing box.

Three optics: Flood, Grazing, and Wall Washer available also in the version with integrated LOUVRE that converges the side light emissions, avoiding the risk of blinding.

Also available in a surface-mounted projector version for both outdoor and indoor installations.





Torre Huaycho

Lighting Design
Gerardo Sanchez Sucsa
Pepe Sanchez Sucsa

Photographer
James Aragón Carrasco

Country
Espinar - Perú

JEDI COMPACT



Recessed IP67 Remote driver L. 344mm

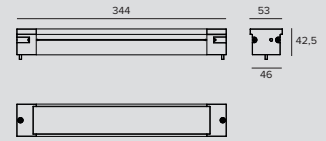

LED / 12W / FLOOD



		3000K	H(m)	D1(m)	D2(m)	E _{max} (lx)	
Ra84			85°	32°			
Fixture Power	14W	1	1.84	0.57	1203		
Source Flux	1720lm	2	3.68	1.14	301		
Fixture Flux	1285lm	3	5.52	1.70	134		
Efficacy	92lm/W	4	7.36	2.27	75		
TS1084	I _{max} =699cd/klm	I _{max}	1203cd	5	9.20	2.84	48

Power supply	Colour	2700K	3000K	3500K	4000K
500mA	●	1E3561	1E3562	1E3563	1E3564

LED / 12W / GRAZING



		3000K	H(m)	D1(m)	D2(m)	E _{max} (lx)	
Ra84			76°	15°			
Fixture Power	14W	1	1.55	0.26	2752		
Source Flux	1720lm	2	3.10	0.51	688		
Fixture Flux	1429lm	3	4.65	0.77	306		
Efficacy	102lm/W	4	6.21	1.02	172		
TS1088	I _{max} =1600cd/klm	I _{max}	2752cd	5	7.76	1.28	110

Power supply	Colour	2700K	3000K	3500K	4000K
500mA	●	1E3565	1E3566	1E3567	1E3568

LED / 12W / WALL WASHER



		3000K	H(m)	D1(m)	D2(m)	E _{max} (lx)	
Ra84			115°	59°			
Fixture Power	14W	1	3.12	1.34	1156		
Source Flux	1720lm	2	6.23	2.67	289		
Fixture Flux	1293lm	3	9.35	4.01	128		
Efficacy	92lm/W	4	12.47	5.35	72		
TS1092	I _{max} =774cd/klm	I _{max}	1331cd	5	15.59	6.69	46

Power supply	Colour	2700K	3000K	3500K	4000K
500mA	●	1E3569	1E3570	1E3571	1E3572

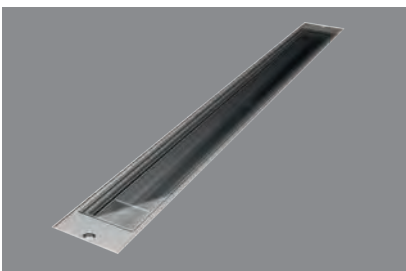

Recessed IP67 Louvre Remote driver L. 344mm

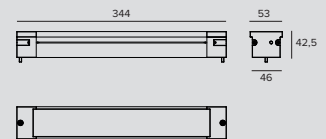

LED / 12W / FLOOD



		3000K	H(m)	D1(m)	D2(m)	E _{max} (lx)	
Ra84			86°	29°			
Fixture Power	14W	1	1.86	0.52	873		
Source Flux	1720lm	2	3.71	1.05	218		
Fixture Flux	752lm	3	5.57	1.57	97		
Efficacy	54lm/W	4	7.42	2.09	55		
TS1086	I _{max} =508cd/klm	I _{max}	873cd	5	9.28	2.62	35

Power supply	Colour	2700K	3000K	3500K	4000K
500mA	●	1E3573	1E3574	1E3575	1E3576

LED / 12W / GRAZING



		3000K	H(m)	D1(m)	D2(m)	E _{max} (lx)
Ra84			80°	13°		
Fixture Power	14W	1	1.68	0.23	1903	
Source Flux	1720lm	2	3.36	0.46	476	
Fixture Flux	912lm	3	5.04	0.68	211	
Efficacy	65lm/W	4	6.72	0.91	119	
TS1090	I _{max} =1106cd/klm	I _{max}	1903cd	5	8.40	1.14 76

Power supply	Colour	2700K	3000K	3500K	4000K
500mA	●	1E3577	1E3578	1E3579	1E3580

LED / 12W / WALL WASHER



		3000K	H(m)	D1(m)	D2(m)	E _{max} (lx)
Ra84			116°	62°		
Fixture Power	14W	1	3.17	1.49	960	
Source Flux	1720lm	2	6.35	2.97	240	
Fixture Flux	975lm	3	9.52	4.46	107	
Efficacy	70lm/W	4	12.70	5.95	60	
TS1094	I _{max} =671cd/klm	I _{max}	1153cd	5	15.87	7.43 38

Power supply	Colour	2700K	3000K	3500K	4000K
500mA	●	1E3581	1E3582	1E3583	1E3584

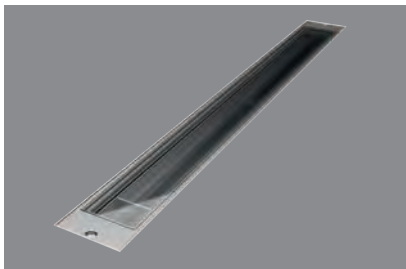

**Recessed IP67
Remote driver L. 625mm**

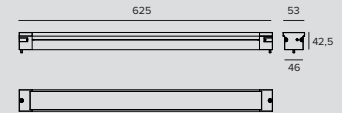

LED / 24W / FLOOD



		3000K	H(m)	D1(m)	D2(m)	E _{max} (lx)
Ra84			85°	32°		
Fixture Power	28W	1	1.84	0.57	2406	
Source Flux	3440lm	2	3.68	1.14	601	
Fixture Flux	2570lm	3	5.52	1.70	267	
Efficacy	92lm/W	4	7.36	2.27	150	
TS1084	I _{max} =699cd/klm	I _{max}	2406cd	5	9.20	2.84 96

Power supply	Colour	2700K	3000K	3500K	4000K
500mA	●	1E3585	1E3586	1E3587	1E3588

LED / 24W / GRAZING



		3000K	H(m)	D1(m)	D2(m)	E _{max} (lx)
Ra84			76°	15°		
Fixture Power	28W	1	1.55	0.26	5505	
Source Flux	3440lm	2	3.10	0.51	1376	
Fixture Flux	2858lm	3	4.65	0.77	612	
Efficacy	102lm/W	4	6.21	1.02	344	
TS1088	I _{max} =1600cd/klm	I _{max}	5505cd	5	7.76	1.28 220

Power supply	Colour	2700K	3000K	3500K	4000K
500mA	●	1E3589	1E3590	1E3591	1E3592

LED / 24W / WALL WASHER



		3000K	H(m)	D1(m)	D2(m)	E _{max} (lx)
Ra84			115°	59°		
Fixture Power	28W	1	3.12	1.34	2312	
Source Flux	3440lm	2	6.23	2.67	578	
Fixture Flux	2586lm	3	9.35	4.01	257	
Efficacy	92lm/W	4	12.47	5.35	145	
TS1092	I _{max} =774cd/klm	I _{max}	2661cd	5	15.59	6.69 92

Power supply	Colour	2700K	3000K	3500K	4000K
500mA	●	1E3593	1E3594	1E3595	1E3596

JEDI COMPACT



Recessed IP67 Louvre Remote driver L. 625mm

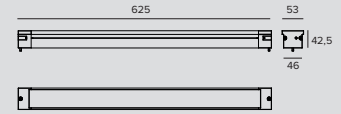

LED / 24W / FLOOD



		3000K	H(m)	D1(m)	D2(m)	E _{max} (lx)	
Ra84			86°	29°			
Fixture Power	28W	1	1.86	0.52	1747		
Source Flux	3440lm	2	3.71	1.05	437		
Fixture Flux	1503lm	3	5.57	1.57	194		
Efficacy	54lm/W	4	7.42	2.09	109		
TS1086	I _{max} =508cd/klm	I _{max}	1747cd	5	9.28	2.62	70

Power supply	Colour	2700K	3000K	3500K	4000K
500mA		1E3597	1E3598	1E3599	1E3600

LED / 24W / GRAZING

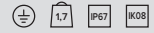

		3000K	H(m)	D1(m)	D2(m)	E _{max} (lx)	
Ra84			80°	13°			
Fixture Power	28W	1	1.68	0.23	3805		
Source Flux	3440lm	2	3.36	0.46	951		
Fixture Flux	1824lm	3	5.04	0.68	423		
Efficacy	65lm/W	4	6.72	0.91	238		
TS1090	I _{max} =1106cd/klm	I _{max}	3805cd	5	8.40	1.14	152

Power supply	Colour	2700K	3000K	3500K	4000K
500mA		1E3601	1E3602	1E3603	1E3604

LED / 24W / WALL WASHER

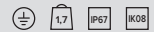

		3000K	H(m)	D1(m)	D2(m)	E _{max} (lx)	
Ra84			116°	62°			
Fixture Power	28W	1	3.17	1.49	1919		
Source Flux	3440lm	2	6.35	2.97	480		
Fixture Flux	1950lm	3	9.52	4.46	213		
Efficacy	70lm/W	4	12.70	5.95	120		
TS1094	I _{max} =671cd/klm	I _{max}	2307cd	5	15.87	7.43	77

Power supply	Colour	2700K	3000K	3500K	4000K
500mA		1E3605	1E3606	1E3607	1E3608

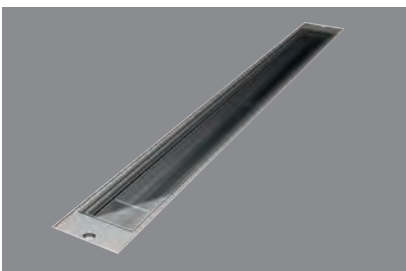

Recessed IP67 Remote driver L. 905mm

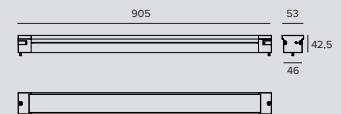

LED / 36W / FLOOD



		3000K	H(m)	D1(m)	D2(m)	E _{max} (lx)	
Ra84			85°	32°			
Fixture Power	40W	1	1.84	0.57	3609		
Source Flux	5160lm	2	3.68	1.14	902		
Fixture Flux	3856lm	3	5.52	1.70	401		
Efficacy	96lm/W	4	7.36	2.27	226		
TS1085	I _{max} =699cd/klm	I _{max}	3609cd	5	9.20	2.84	144

Power supply	Colour	2700K	3000K	3500K	4000K
500mA		1E3609	1E3610	1E3611	1E3612

LED / 36W / GRAZING



		3000K	H(m)	D1(m)	D2(m)	E _{max} (lx)	
Ra84				76°	15°		
Fixture Power	40W	1	1.55	0.26	8259		
Source Flux	5160lm	2	3.10	0.51	2065		
Fixture Flux	4288lm	3	4.65	0.77	918		
Efficacy	107lm/W	4	6.21	1.02	516		
TS1089	I _{max} =1601cd/klm	I _{max}	8259cd	5	7.76	1.28	330

Power supply	Colour	2700K	3000K	3500K	4000K
500mA	●	1E3613	1E3614	1E3615	1E3616

LED / 36W / WALL WASHER

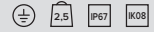

		3000K	H(m)	D1(m)	D2(m)	E _{max} (lx)	
Ra84				115°	59°		
Fixture Power	40W	1	3.12	1.34	3469		
Source Flux	5160lm	2	6.23	2.67	867		
Fixture Flux	3880lm	3	9.35	4.01	385		
Efficacy	97lm/W	4	12.47	5.35	217		
TS1093	I _{max} =774cd/klm	I _{max}	3992cd	5	15.59	6.69	139

Power supply	Colour	2700K	3000K	3500K	4000K
500mA	●	1E3617	1E3618	1E3619	1E3620

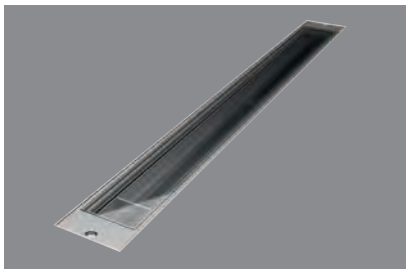

Recessed IP67 Louvre Remote driver L. 905mm

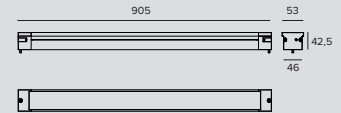

LED / 36W / FLOOD

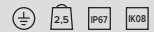

		3000K	H(m)	D1(m)	D2(m)	E _{max} (lx)	
Ra84				86°	29°		
Fixture Power	40W	1	1.86	0.52	2620		
Source Flux	5160lm	2	3.71	1.05	655		
Fixture Flux	2255lm	3	5.57	1.57	291		
Efficacy	56lm/W	4	7.42	2.09	164		
TS1087	I _{max} =508cd/klm	I _{max}	2620cd	5	9.28	2.62	105

Power supply	Colour	2700K	3000K	3500K	4000K
500mA	●	1E3621	1E3622	1E3623	1E3624

LED / 36W / GRAZING

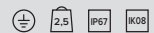

		3000K	H(m)	D1(m)	D2(m)	E _{max} (lx)	
Ra84				80°	13°		
Fixture Power	40W	1	1.68	0.23	5707		
Source Flux	5160lm	2	3.36	0.46	1427		
Fixture Flux	2735lm	3	5.04	0.68	634		
Efficacy	68lm/W	4	6.72	0.91	357		
TS1091	I _{max} =1106cd/klm	I _{max}	5707cd	5	8.40	1.14	228

Power supply	Colour	2700K	3000K	3500K	4000K
500mA	●	1E3625	1E3626	1E3627	1E3628

LED / 36W / WALL WASHER



		3000K	H(m)	D1(m)	D2(m)	E _{max} (lx)	
Ra84				116°	52°		
Fixture Power	40W	1	3.17	1.49	2879		
Source Flux	5160lm	2	6.35	2.97	720		
Fixture Flux	2926lm	3	9.52	4.46	320		
Efficacy	73lm/W	4	12.70	5.95	180		
TS1095	I _{max} =671cd/klm	I _{max}	3460cd	5	15.87	7.43	115

Power supply	Colour	2700K	3000K	3500K	4000K
500mA	●	1E3629	1E3630	1E3631	1E3632

JEDI COMPACT



Recessed IP67 Remote driver L. 1185mm

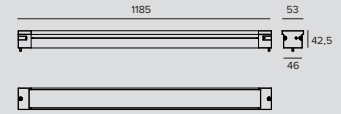

LED / 48W / FLOOD



	3000K	H(m)	D1(m)	D2(m)	E _{max} (lx)		
Ra84		85°	32°				
Fixture Power	53W	1	1.84	0.57	4812		
Source Flux	6880lm	2	3.68	1.14	1203		
Fixture Flux	5141lm	3	5.52	1.70	535		
Efficacy	97lm/W	4	7.36	2.27	301		
TS1085	I _{max} =699cd/klm	I _{max}	4812cd	5	9.20	2.84	192

Power supply	Colour	2700K	3000K	3500K	4000K
500mA	●	1E3633	1E3634	1E3635	1E3636

LED / 48W / GRAZING



	3000K	H(m)	D1(m)	D2(m)	E _{max} (lx)		
Ra84		76°	15°				
Fixture Power	53W	1	1.55	0.26	11012		
Source Flux	6880lm	2	3.10	0.51	2753		
Fixture Flux	5717lm	3	4.65	0.77	1224		
Efficacy	108lm/W	4	6.21	1.02	688		
TS1089	I _{max} =1601cd/klm	I _{max}	11012cd	5	7.76	1.28	440

Power supply	Colour	2700K	3000K	3500K	4000K
500mA	●	1E3637	1E3638	1E3639	1E3640

LED / 48W / WALL WASHER

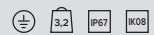

	3000K	H(m)	D1(m)	D2(m)	E _{max} (lx)		
Ra84		115°	59°				
Fixture Power	53W	1	3.12	1.34	4625		
Source Flux	6880lm	2	6.23	2.67	1156		
Fixture Flux	5173lm	3	9.35	4.01	514		
Efficacy	98lm/W	4	12.47	5.35	289		
TS1093	I _{max} =774cd/klm	I _{max}	5323cd	5	15.59	6.69	185

Power supply	Colour	2700K	3000K	3500K	4000K
500mA	●	1E3641	1E3642	1E3643	1E3644



Recessed IP67 Louvre Remote driver L. 1185mm

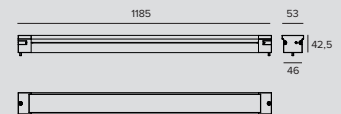

LED / 48W / FLOOD



	3000K	H(m)	D1(m)	D2(m)	E _{max} (lx)		
Ra84		86°	29°				
Fixture Power	53W	1	1.86	0.52	3494		
Source Flux	6880lm	2	3.71	1.05	873		
Fixture Flux	3007lm	3	5.57	1.57	388		
Efficacy	57lm/W	4	7.42	2.09	218		
TS1087	I _{max} =508cd/klm	I _{max}	3494cd	5	9.28	2.62	140

Power supply	Colour	2700K	3000K	3500K	4000K
500mA	●	1E3645	1E3646	1E3647	1E3648

LED / 48W / GRAZING



		3000K	H(m)	D1(m)	D2(m)	E _{max} (lx)	
Ra84			80°	13°			
Fixture Power	53W	1	1.68	0.23	7609		
Source Flux	6880lm	2	3.36	0.46	1902		
Fixture Flux	3646lm	3	5.04	0.68	845		
Efficacy	69lm/W	4	6.72	0.91	476		
TS1091	I _{max} =1106cd/klm	I _{max}	7609cd	5	8.40	1.14	304

Power supply	Colour	2700K	3000K	3500K	4000K
500mA	●	1E3649	1E3650	1E3651	1E3652

LED / 48W / WALL WASHER

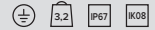

		3000K	H(m)	D1(m)	D2(m)	E _{max} (lx)	
Ra84			116°	62°			
Fixture Power	53W	1	3.17	1.49	3838		
Source Flux	6880lm	2	6.35	2.97	960		
Fixture Flux	3901lm	3	9.52	4.46	426		
Efficacy	74lm/W	4	12.70	5.95	240		
TS1095	I _{max} =671cd/klm	I _{max}	4613cd	5	15.87	7.43	154

Power supply	Colour	2700K	3000K	3500K	4000K
500mA	●	1E3653	1E3654	1E3655	1E3656

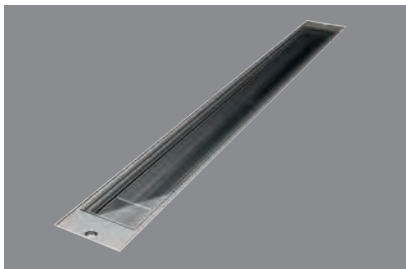

**Recessed IP67
Integrated driver L. 625mm**

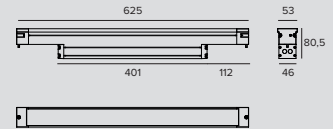

LED / 24W / FLOOD



		3000K	H(m)	D1(m)	D2(m)	E _{max} (lx)	
Ra84			85°	32°			
Fixture Power	28W	1	1.84	0.57	2406		
Source Flux	3440lm	2	3.68	1.14	601		
Fixture Flux	2570lm	3	5.52	1.70	267		
Efficacy	92lm/W	4	7.36	2.27	150		
TS1084	I _{max} =699cd/klm	I _{max}	2406cd	5	9.20	2.84	96

Driver	Colour	2700K	3000K	3500K	4000K
EL.	●	1E3657EL	1E3658EL	1E3659EL	1E3660EL
DALI	●	1E3657DA	1E3658DA	1E3659DA	1E3660DA

LED / 24W / GRAZING

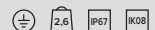

		3000K	H(m)	D1(m)	D2(m)	E _{max} (lx)	
Ra84			76°	15°			
Fixture Power	28W	1	1.55	0.26	5505		
Source Flux	3440lm	2	3.10	0.51	1376		
Fixture Flux	2858lm	3	4.65	0.77	612		
Efficacy	102lm/W	4	6.21	1.02	344		
TS1088	I _{max} =1600cd/klm	I _{max}	5505cd	5	7.76	1.28	220

Driver	Colour	2700K	3000K	3500K	4000K
EL.	●	1E3661EL	1E3662EL	1E3663EL	1E3664EL
DALI	●	1E3661DA	1E3662DA	1E3663DA	1E3664DA

LED / 24W / WALL WASHER



		3000K	H(m)	D1(m)	D2(m)	E _{max} (lx)	
Ra84			115°	59°			
Fixture Power	28W	1	3.12	1.34	2312		
Source Flux	3440lm	2	6.23	2.67	578		
Fixture Flux	2586lm	3	9.35	4.01	257		
Efficacy	92lm/W	4	12.47	5.35	145		
TS1092	I _{max} =774cd/klm	I _{max}	2661cd	5	15.59	6.69	92

Driver	Colour	2700K	3000K	3500K	4000K
EL.	●	1E3665EL	1E3666EL	1E3667EL	1E3668EL
DALI	●	1E3665DA	1E3666DA	1E3667DA	1E3668DA

JEDI COMPACT



Recessed IP67 Louvre Integrated driver L. 625mm

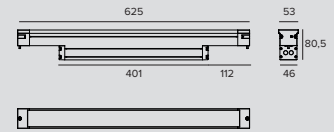

LED / 24W / FLOOD



	3000K	H(m)	D1(m)	D2(m)	E _{max} (lx)		
Ra84			86°	29°			
Fixture Power	28W	1	1.86	0.52	1747		
Source Flux	3440lm	2	3.71	1.05	437		
Fixture Flux	1503lm	3	5.57	1.57	194		
Efficacy	54lm/W	4	7.42	2.09	109		
TS1086	I _{max} =508cd/klm	I _{max}	1747cd	5	9.28	2.62	70

Driver	Colour	2700K	3000K	3500K	4000K
EL.	●	1E3669EL	1E3670EL	1E3671EL	1E3672EL
DALI	●	1E3669DA	1E3670DA	1E3671DA	1E3672DA

LED / 24W / GRAZING

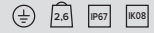

	3000K	H(m)	D1(m)	D2(m)	E _{max} (lx)		
Ra84			80°	13°			
Fixture Power	28W	1	1.68	0.23	3805		
Source Flux	3440lm	2	3.36	0.46	951		
Fixture Flux	1824lm	3	5.04	0.68	423		
Efficacy	65lm/W	4	6.72	0.91	238		
TS1090	I _{max} =1106cd/klm	I _{max}	3805cd	5	8.40	1.14	152

Driver	Colour	2700K	3000K	3500K	4000K
EL.	●	1E3673EL	1E3674EL	1E3675EL	1E3676EL
DALI	●	1E3673DA	1E3674DA	1E3675DA	1E3676DA

LED / 24W / WALL WASHER

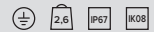

	3000K	H(m)	D1(m)	D2(m)	E _{max} (lx)		
Ra84			116°	62°			
Fixture Power	28W	1	3.17	1.49	1919		
Source Flux	3440lm	2	6.35	2.97	480		
Fixture Flux	1950lm	3	9.52	4.46	213		
Efficacy	70lm/W	4	12.70	5.95	120		
TS1094	I _{max} =671cd/klm	I _{max}	2307cd	5	15.87	7.43	77

Driver	Colour	2700K	3000K	3500K	4000K
EL.	●	1E3677EL	1E3678EL	1E3679EL	1E3680EL
DALI	●	1E3677DA	1E3678DA	1E3679DA	1E3680DA

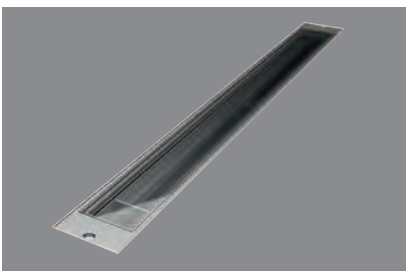

Recessed IP67 Integrated driver L. 905mm

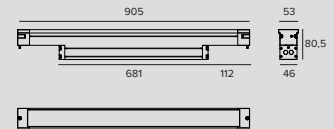

LED / 36W / FLOOD



	3000K	H(m)	D1(m)	D2(m)	E _{max} (lx)		
Ra84			85°	32°			
Fixture Power	40W	1	1.84	0.57	3609		
Source Flux	5160lm	2	3.68	1.14	902		
Fixture Flux	3856lm	3	5.52	1.70	401		
Efficacy	96lm/W	4	7.36	2.27	226		
TS1085	I _{max} =699cd/klm	I _{max}	3609cd	5	9.20	2.84	144

Driver	Colour	2700K	3000K	3500K	4000K
EL.	●	1E3681EL	1E3682EL	1E3683EL	1E3684EL
DALI	●	1E3681DA	1E3682DA	1E3683DA	1E3684DA

LED / 36W / GRAZING



		3000K	H(m)	D1(m)	D2(m)	E _{max} (lx)	
Ra84			76°	15°			
Fixture Power	40W	1	1.55	0.26	8259		
Source Flux	5160lm	2	3.10	0.51	2065		
Fixture Flux	4288lm	3	4.65	0.77	918		
Efficacy	107lm/W	4	6.21	1.02	516		
TS1089	I _{max} =1601cd/klm	I _{max}	8259cd	5	7.76	1.28	330

Driver	Colour	2700K	3000K	3500K	4000K
EL.	●	1E3685EL	1E3686EL	1E3687EL	1E3688EL
DALI	●	1E3685DA	1E3686DA	1E3687DA	1E3688DA

LED / 36W / WALL WASHER



		3000K	H(m)	D1(m)	D2(m)	E _{max} (lx)	
Ra84			115°	59°			
Fixture Power	40W	1	3.12	1.34	3469		
Source Flux	5160lm	2	6.23	2.67	867		
Fixture Flux	3880lm	3	9.35	4.01	385		
Efficacy	97lm/W	4	12.47	5.35	217		
TS1093	I _{max} =774cd/klm	I _{max}	3992cd	5	15.59	6.69	139

Driver	Colour	2700K	3000K	3500K	4000K
EL.	●	1E3689EL	1E3690EL	1E3691EL	1E3692EL
DALI	●	1E3689DA	1E3690DA	1E3691DA	1E3692DA

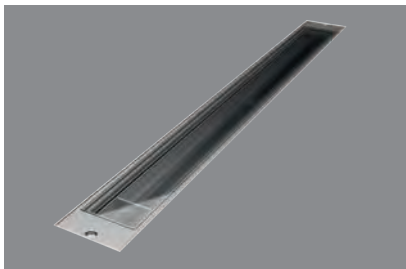

**Recessed IP67 Louvre
Integrated driver L. 905mm**

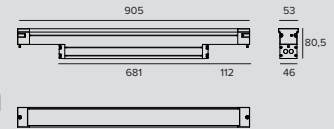

LED / 36W / FLOOD



		3000K	H(m)	D1(m)	D2(m)	E _{max} (lx)	
Ra84			86°	29°			
Fixture Power	40W	1	1.86	0.52	2620		
Source Flux	5160lm	2	3.71	1.05	655		
Fixture Flux	2255lm	3	5.57	1.57	291		
Efficacy	56lm/W	4	7.42	2.09	164		
TS1087	I _{max} =508cd/klm	I _{max}	2620cd	5	9.28	2.62	105

Driver	Colour	2700K	3000K	3500K	4000K
EL.	●	1E3693EL	1E3694EL	1E3695EL	1E3696EL
DALI	●	1E3693DA	1E3694DA	1E3695DA	1E3696DA

LED / 36W / GRAZING

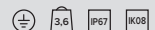

		3000K	H(m)	D1(m)	D2(m)	E _{max} (lx)	
Ra84			80°	13°			
Fixture Power	40W	1	1.68	0.23	5707		
Source Flux	5160lm	2	3.36	0.46	1427		
Fixture Flux	2735lm	3	5.04	0.68	634		
Efficacy	68lm/W	4	6.72	0.91	357		
TS1091	I _{max} =1106cd/klm	I _{max}	5707cd	5	8.40	1.14	228

Driver	Colour	2700K	3000K	3500K	4000K
EL.	●	1E3697EL	1E3698EL	1E3699EL	1E3700EL
DALI	●	1E3697DA	1E3698DA	1E3699DA	1E3700DA

LED / 36W / WALL WASHER



		3000K	H(m)	D1(m)	D2(m)	E _{max} (lx)	
Ra84			116°	82°			
Fixture Power	40W	1	3.17	1.49	2879		
Source Flux	5160lm	2	6.35	2.97	720		
Fixture Flux	2926lm	3	9.52	4.46	320		
Efficacy	73lm/W	4	12.70	5.95	180		
TS1095	I _{max} =671cd/klm	I _{max}	3460cd	5	15.87	7.43	115

Driver	Colour	2700K	3000K	3500K	4000K
EL.	●	1E3701EL	1E3702EL	1E3703EL	1E3704EL
DALI	●	1E3701DA	1E3702DA	1E3703DA	1E3704DA

JEDI COMPACT



Recessed IP67 Integrated driver L. 1185mm

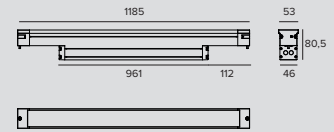

LED / 48W / FLOOD



		3000K	H(m)	D1(m)	D2(m)	E _{max} (lx)	
Ra84				85°	32°		
Fixture Power	53W	1	1.84	0.57	4812		
Source Flux	6880lm	2	3.68	1.14	1203		
Fixture Flux	5141lm	3	5.52	1.70	535		
Efficacy	97lm/W	4	7.36	2.27	301		
TS1085	I _{max} =699cd/klm	I _{max}	4812cd	5	9.20	2.84	192

Driver	Colour	2700K	3000K	3500K	4000K
EL.	●	1E3705EL	1E3706EL	1E3707EL	1E3708EL
DALI	●	1E3705DA	1E3706DA	1E3707DA	1E3708DA

LED / 48W / GRAZING



		3000K	H(m)	D1(m)	D2(m)	E _{max} (lx)	
Ra84				76°	15°		
Fixture Power	53W	1	1.55	0.26	11012		
Source Flux	6880lm	2	3.10	0.51	2753		
Fixture Flux	5717lm	3	4.65	0.77	1224		
Efficacy	108lm/W	4	6.21	1.02	688		
TS1089	I _{max} =1601cd/klm	I _{max}	11012cd	5	7.76	1.28	440

Driver	Colour	2700K	3000K	3500K	4000K
EL.	●	1E3709EL	1E3710EL	1E3711EL	1E3712EL
DALI	●	1E3709DA	1E3710DA	1E3711DA	1E3712DA

LED / 48W / WALL WASHER

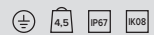

		3000K	H(m)	D1(m)	D2(m)	E _{max} (lx)	
Ra84				115°	59°		
Fixture Power	53W	1	3.12	1.34	4625		
Source Flux	6880lm	2	6.23	2.67	1156		
Fixture Flux	5173lm	3	9.35	4.01	514		
Efficacy	98lm/W	4	12.47	5.35	289		
TS1093	I _{max} =774cd/klm	I _{max}	5323cd	5	15.59	6.69	185

Driver	Colour	2700K	3000K	3500K	4000K
EL.	●	1E3713EL	1E3714EL	1E3715EL	1E3716EL
DALI	●	1E3713DA	1E3714DA	1E3715DA	1E3716DA

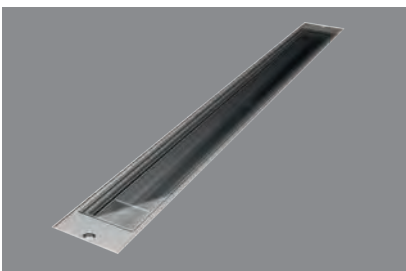

Recessed IP67 Louvre Integrated driver L. 1185mm

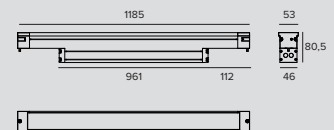

LED / 48W / FLOOD



		3000K	H(m)	D1(m)	D2(m)	E _{max} (lx)	
Ra84				86°	29°		
Fixture Power	53W	1	1.86	0.52	3494		
Source Flux	6880lm	2	3.71	1.05	873		
Fixture Flux	3007lm	3	5.57	1.57	388		
Efficacy	57lm/W	4	7.42	2.09	218		
TS1087	I _{max} =508cd/klm	I _{max}	3494cd	5	9.28	2.62	140

Driver	Colour	2700K	3000K	3500K	4000K
EL.	●	1E3717EL	1E3718EL	1E3719EL	1E3720EL
DALI	●	1E3717DA	1E3718DA	1E3719DA	1E3720DA

Note

To be completed with an anodised aluminium outer casing suitable for in-line installation and external looping.

LED / 48W / GRAZING



		3000K	H(m)	D1(m)	D2(m)	E _{max} (lx)	
Ra84				80°	13°		
Fixture Power	53W	1	1.68	0.23	7609		
Source Flux	6880lm	2	3.36	0.46	1902		
Fixture Flux	3646lm	3	5.04	0.68	845		
Efficacy	69lm/W	4	6.72	0.91	476		
TS1091	Imax=1106cd/klm	Imax	7609cd	5	8.40	1.14	304

Driver	Colour	2700K	3000K	3500K	4000K
EL.		1E3721EL	1E3722EL	1E3723EL	1E3724EL
DALI		1E3721DA	1E3722DA	1E3723DA	1E3724DA

Note

To be completed with an anodised aluminium outer casing suitable for in-line installation and external looping.

LED / 48W / WALL WASHER



		3000K	H(m)	D1(m)	D2(m)	E _{max} (lx)	
Ra84				116°	62°		
Fixture Power	53W	1	3.17	1.49	3838		
Source Flux	6880lm	2	6.35	2.97	960		
Fixture Flux	3901lm	3	9.52	4.46	426		
Efficacy	74lm/W	4	12.70	5.95	240		
TS1095	Imax=671cd/klm	Imax	4613cd	5	15.87	7.43	154

Driver	Colour	2700K	3000K	3500K	4000K
EL.		1E3725EL	1E3726EL	1E3727EL	1E3728EL
DALI		1E3725DA	1E3726DA	1E3727DA	1E3728DA

Note

To be completed with an anodised aluminium outer casing suitable for in-line installation and external looping.

Related codes

Insertion Box

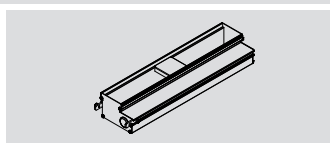

L	Code
348	1E3729
629	1E3730
909	1E3731
1189	1E3732

Outer casing for Jedi Compact with remote driver.

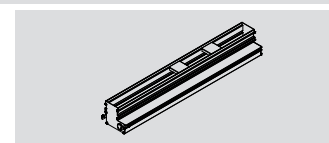

L	Code
629	1E3733
909	1E3734
1189	1E3735

Outer casing for Jedi Compact with integrated driver.

Power Supply



Code
1E3557

EL power supply version kit composed of a aluminium watertight box (LxHxP=270x49.5x44mm) complete with power supply input cable (1 metre, type H07RN-F, 3G1mm²) and an output cable to the fixture (1 metre, type H07RN-F, 3G1mm²).

For the L 312.5/344mm versions.



Code
1E3558

EL power supply version kit composed of a aluminium watertight box (LxHxP=486x49.5x44mm) complete with power supply input cable (1 metre, type H07RN-F, 3G1mm²) and an output cable to the fixture (1 metre, type H07RN-F, 3G1mm²).

For the L 593.5/625/873.5/905/1153.5/1185mm versions.

JEDI COMPACT

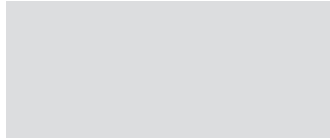

Code

1E3559

DALI power supply version kit composed of a aluminium watertight box (LxHxP=486x49.5x44mm) complete with power supply input cable (1 metre, type H07RN-F, 5G1mm²) and an output cable to the fixture (1 metre, type H07RN-F, 3G1mm²).
For the L 312.5/344/593.5/625mm versions.

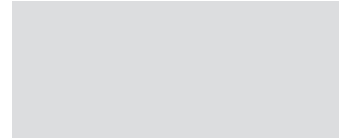

Code

1E3560

DALI power supply version kit composed of a aluminium watertight box (LxHxP=486x49.5x44mm) complete with power supply input cable (1 metre, type H07RN-F, 5G1mm²) and an output cable to the fixture (1 metre, type H07RN-F, 3G1mm²).
For the L 873.5/905/1153.5/1185mm versions.

Accessories

Tool

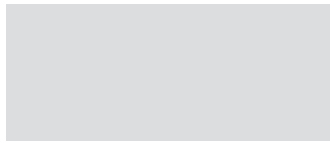

Code

1E3305

(Tightening) wrench for the connector kit.

Connector

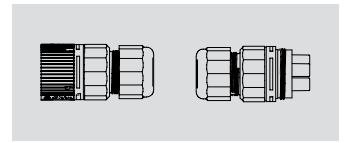

Code

1E2769

Connectors kit for 5 pole coaxial connections.

Control systems

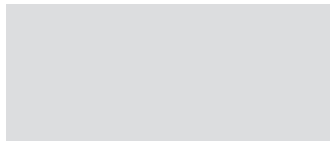

Code

1E3048

A IP67 Module for individual control of external devices equipped with DALI drivers. The module needs to be positioned in order to receive radio signals. The distance to the lighting fixtures can reach up to 50m.

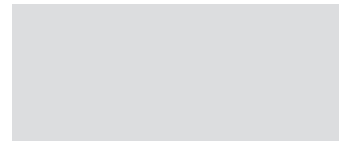

Code

1E3049

IP67 Extender for wireless control of DALI fixtures. It generates a local DALI bus with the capacity to drive up to 64 fixtures. Can control DALI fixtures in outdoor applications.



MERCURE

GENERAL INFO

Inground linear fixture.
Lengths: 300mm - 600mm

LED

Linear boards
From 74lm to 1750lm
3000K – 4000K – RGB
Ra84 – Ra80

PRODUCT EFFICACY

Up to 59lm/W

OPTICS

VWFL

POWER SUPPLY

Electronic

MATERIAL

Die-cast aluminium housing.
Anti slip, flush, tempered safety glass.

A range of compact inground recessed linear light fixtures with a flush “all glass” finish” for particularly striking and elegant installation in continuous rows. Mercure comes in three different sizes to light shapes with monochromatic or RGB light.

The larger versions combine elegance and high performance; the smaller version combines a compact size, elegant design and resistance in a unique linear glass fixture that can meet walk-over requirements.

The cataphoresis treatment of MINI MERCURE makes it possible for installations of up to 1 metre away from the sea.





Private Residence

Photographer
©SAC Design

Country
Huntington Beach,
USA

MERCURE



Light-line



LED / 12W / VWFL



		3000K	H(m)	D(m)	Emax(lx)
		Ra84		116°	
Fixture Power	15W	1	3.21	278	
Source Flux	1720lm	2	6.43	69	
Fixture Flux	849lm	3	9.64	31	
Efficacy	57lm/W	4	12.85	17	
EV338	Imax=161cd/klm	Imax	278cd	5	16.07
				11	

Driver	Colour	3000K	4000K
EL.		1E2274	1E2275

T16 G5 / 24W / VWFL



		4000K	H(m)	D(m)	Emax(lx)
		Ra80		109°	
Fixture Power	24W	1	2.83	177	
Source Flux	1750lm	2	5.66	44	
Fixture Flux	493lm	3	8.49	20	
Efficacy	21lm/W	4	11.32	11	
EV128	Imax=101cd/klm	Imax	177cd	5	14.15
				7	

Driver	Colour	Code
EL.		1E2272

Note

Supplied with an IP68 coaxial connection kit.

Related codes

Insertion Box

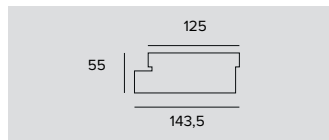

Code

1E2264

Anodized aluminium insertion box available in three different heights to satisfy any installation need.
Complete with removable end caps for in-line installation.
Low.

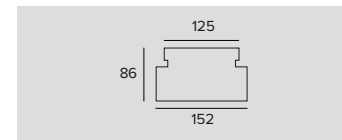

Code

1E2265

Anodized aluminium insertion box available in three different heights to satisfy any installation need.
Complete with removable end caps for in-line installation.
Medium.

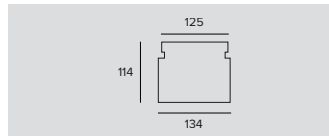

Code

1E2266

Anodized aluminium insertion box available in three different heights to satisfy any installation need.
Complete with removable end caps for in-line installation.
High.

Accessories

Tool



Code

1E0388

Sucker tool to raise the glass.

MERCURE

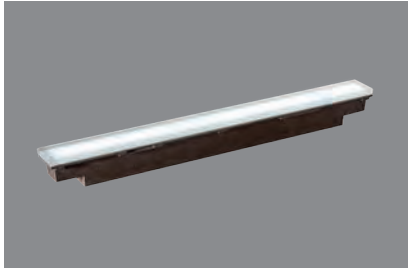

MINIMERCURE LED

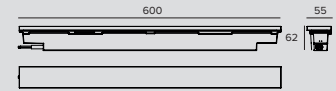

LED / 8W / VWFL 1.8 IP67 IK05 1.5m

	3000K	Insulation	Power supply	Driver	Colour	3000K	4000K
	Ra84	CLASS 3	24Vdc			1E3406	1E3407
	Fixture Power 9W	CLASS 2	220-240Vac	EL.		1E3404	1E3405
	Source Flux 1260lm						
	Fixture Flux 290lm						
Efficacy 32lm/W							
T5775	Imax=71cd/klm						
	Imax						90cd

Related codes

Insertion Box

Code
1E2382

Aluminium insertion boxes with horizontal or vertical development pre-set with removable end caps for installations in continuous rows. Complete with internal supports for installations in concrete.
Vertical

Code
1E2383

Aluminium insertion boxes with horizontal or vertical development pre-set with removable end caps for installations in continuous rows. Complete with internal supports for installations in concrete.
Horizontal

Power Supply

Code
1T3586

Electronic power supply 75W, LxHxP=130x32x80mm, 220-240V, 24V-DC, IP67.



MINIMERCURE RGB

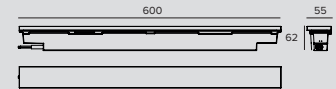

LED RGB / 8W / VWFL



	H(m)	D1(m)	D2(m)	E _{max} (lx)			
		117°	129°				
Fixture Power	9W	1	3.27	4.16	25		
Source Flux	83lm	2	6.55	8.31	6		
Fixture Flux	82lm	3	9.82	12.47	3		
Efficacy	10lm/W	4	13.09	16.63	2		
TS775	Imax=302cd/klm	Imax	25cd	5	16.37	20.79	1

Power supply	Colour	RGB
24Vdc		1E2381

Note

Photometrics show the maximum emission values of fixtures.

Related codes

Insertion Box

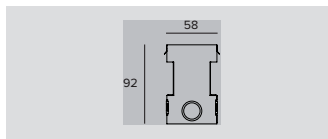

Code

1E2382

Aluminium insertion boxes with horizontal or vertical development pre-set with removable end caps for installations in continuous rows.
Complete with internal supports for installations in concrete.
Vertical

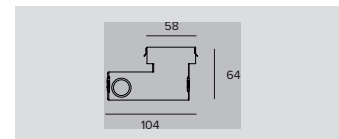

Code

1E2383

Aluminium insertion boxes with horizontal or vertical development pre-set with removable end caps for installations in continuous rows.
Complete with internal supports for installations in concrete.
Horizontal

Control systems



Code

1E1401

SECS 75.
Power supply and Control System SECS Scene Effect Control System.
SECS 75 drivers combine the following 3 functions in a single unit.: power supply to RGB LED devices, playback of pre-set colour sequences and a DMX interface for external control devices.
The SECS "Easy-Run-Menu" function is able to playback colour-changing light scenarios that are pre-stored into the driver without the use of an external driver: - 8 static colour scenarios; - 8 dynamic colour sequences; - 5 different playback speed values; - Start/Stop the selected scenario using a remote switch.
SECS 75 drivers can also be controlled through DMX 512; in this case: - DMX address (from 1 to 511) can be configured by using dip-switches; - 3 channel mode: all R-G-B outputs are controlled simultaneously by 3 DMX channels only; - 6 channel mode: the outputs are divided into 2 R-G-B groups, each one controlled by 3 different DMX channels; - DMX line termination: SECS drivers contain a 120Ohm resistance which can be activated using a dip-switch; - DMX output is available for connection to other DMX devices.
75W output IP67



Code

1T1827

SECS 75.
Power supply and Control System SECS Scene Effect Control System.
SECS 75 drivers combine the following 3 functions in a single unit.: power supply to RGB LED devices, playback of pre-set colour sequences and a DMX interface for external control devices.
The SECS "Easy-Run-Menu" function is able to playback colour-changing light scenarios that are pre-stored into the driver without the use of an external driver: - 8 static colour scenarios; - 8 dynamic colour sequences; - 5 different playback speed values; - Start/Stop the selected scenario using a remote switch.
SECS 75 drivers can also be controlled through DMX 512; in this case: - DMX address (from 1 to 511) can be configured by using dip-switches; - 3 channel mode: all R-G-B outputs are controlled simultaneously by 3 DMX channels only; - 6 channel mode: the outputs are divided into 2 R-G-B groups, each one controlled by 3 different DMX channels; - DMX line termination: SECS drivers contain a 120Ohm resistance which can be activated using a dip-switch; - DMX output is available for connection to other DMX devices.
75W output IP20

MERCURE

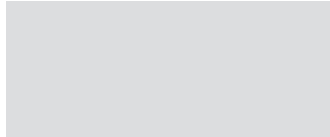

Code

1T2245

SECS 36 -IP20

Power supply and Control System SECS Scene Effect Control System.

SECS 36 drivers combine the following 3 functions in a single unit: power supply to RGB LED devices, playback of pre-set colour sequences and a DMX interface for external control devices.

The SECS "Easy-Run-Menu" function is able to playback colour-changing light scenarios that are pre-stored into the driver without the use of an external driver: - 8 static colour scenarios; - 8 dynamic colour sequences; - 5 different playback speed values; - Start/Stop the selected scenario using a remote switch.

SECS 75 drivers can also be controlled through DMX 512; in this case: - DMX address (from 1 to 511) can be configured by using dip-switches; - 3 channel mode: all R-G-B outputs are controlled simultaneously by 3 DMX channels only; - 6 channel mode: the outputs are divided into 2 R-G-B groups, each one controlled by 3 different DMX channels; - DMX line termination: SECS drivers contain a 120Ohm resistance which can be activated using a dip-switch; - DMX output is available for connection to other DMX devices.

35W output.

Accessories

Cable

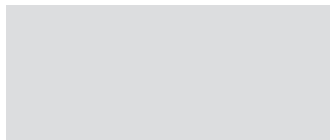

Code

1T1932

Standard DMX cable (1 twisted pair + shield, 120Ohm).

Control systems

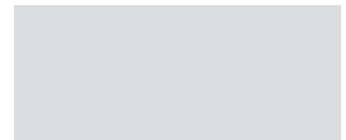

Code

1T1898

my-SCENARIO Show Store.

Digital devices designed to control dynamic lighting fixtures and programme dynamic light scenarios and sequences.

The system consists of intuitive software, compatible with Windows operating systems, able to control different hardware devices with the following functions: - record colour-changing scenarios set by the operator; - allow selection among the multiple scenarios already recorded; - transmit the control signals to the lighting system.

The software is interfaced to the PC through a USB port; the interface with lighting fixtures is featured through a DMX 512 output.

The software provides a graphic simulation of the operating keys of a lighting controller; the patching function allows the DMX control channels to be assigned to fixtures by using the internal library.

The Colour Manager function allows for quick and intuitive programming of a RGB light show, consisting of several steps with assigned duration and fading times.

The built-in calendar allows full time scheduling of show playback (month, day, hour, minutes, recurring events).

The programmed light shows can be transferred to different control interfaces.



MICROMERCURE

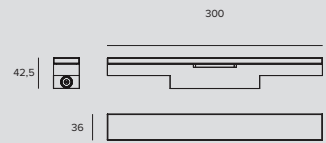

LED / 3W / VWFL

	3000K	
	Ra80	
	Fixture Power 3W	
	Source Flux 74lm	
	Fixture Flux 74lm	
	Efficacy 25lm/W	
EV326	Imax=279cd/klm	Imax 21cd

	Power supply	Colour	3000K	4000K
	12Vdc		1E2267	1E2268

Related codes

Insertion Box

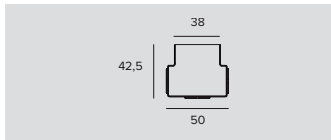

Code
1E2269

Galvanized metal insertion box.
Complete with removable end caps for in-line installation.

Power Supply

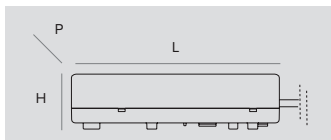

Code
T1585

Electronic power supply for 10/20W LED, LxHxP=145x19x55mm, 110-240V/220-240V-AC, 12V-DC, IP20.
Non-dimmable.
For Micromercure: up to 6 fixtures connected in parallel.

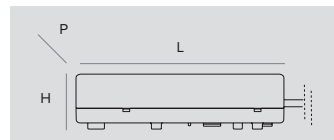

Code
T1586

Electronic power supply for 70W LED, LxHxP=225x51x65mm, 220-240V-AC, 12V-DC, IP65.
Non-dimmable.
For Micromercure: up to 22 fixtures connected in parallel.

KEPLERO

GENERAL INFO

Recessed professional projector.
ø280mm - ø161mm

LED

Chip on board for ZOOM – WALL WASHER versions
Emitter for RGBW – GIMBAL versions
From 826lm to 4665lm
3000K – 4000K
Ra84

PRODUCT EFFICACY

Up to 106lm/W

OPTICS

SP – FL – MWFL – WFL
WALL WASHER

POWER SUPPLY

Electronic – DALI – 1-10V

MATERIAL

Anodized and black painted die-cast aluminium body.
Brushed stainless steel ultra flat decorative ring with
bevelled edge.

A complete range of recessed LED up-lights for outdoor lighting. The two different sizes with a wide range of optics with white LED or RGBW lamps with different lumens are the expression of versatility and performance.





The Pools

Architect
Studio K1

Photographer
©Brad Nelson

Country
Irvine - USA

01
Keplero



ZOOM
Spot, Flood, Medium wide
Flood, Wide flood



GIMBAL
Narrow spot, Flood,
Flood rectangle



GIMBAL HP
Narrow spot, Spot, Flood

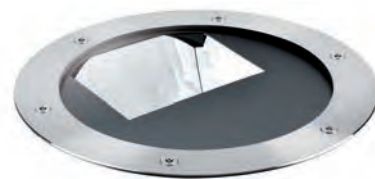

WALL WASHER

A powerful solution

And an ideal and flexible choice for lighting large and small public spaces, building facades and trees given its size and high performance.

02 Keplero Mini



ZOOM
Spot, Flood, Medium wide flood,
Wide flood



GIMBAL
Spot, Flood



HI-EFFICACY
Spot, Flood, Medium wide flood



WALL WASHER

A compact version

With only 166mm in diameter and has a maximum installation depth of just 200mm. It takes its technology and flexibility from the large version but given its dimensions and high performance it is also suitable for external lighting such as building facades and small trees.

03 Zoom



Versions with remote or driver included

The large versions of KEPLERO are available with an integrated electronic 220-240V driver, while the KEPLERO MINI has a range with both an integrated 110-240V driver and a remote 48V driver making it easier to connect several fixtures to the same driver that is available as an accessory. Cabling is simply through IP68 connectors that are equipped for IN and OUT looping. Available with a DALI on request.

Perfect solidity and stillness of an inground recessed fixture

Contrasts with the dynamism of a unique optical system that gives life the countless luminous effects. The effect can change at any time thanks to its innovative patented optical system.

Beam orientation is guided transferring the optical chamber towards the surface to be lit with a beam orientation of up to 20°. In just a few simple steps the fixture can change the width of the beam emission from spot to wide flood: Extraction for focusing, transfer and rotation are the three different possible movements the KEPLERO optical chamber can perform. Graded rings help to identify orientation and thus make replication simple.

04 Keplero Gimbal

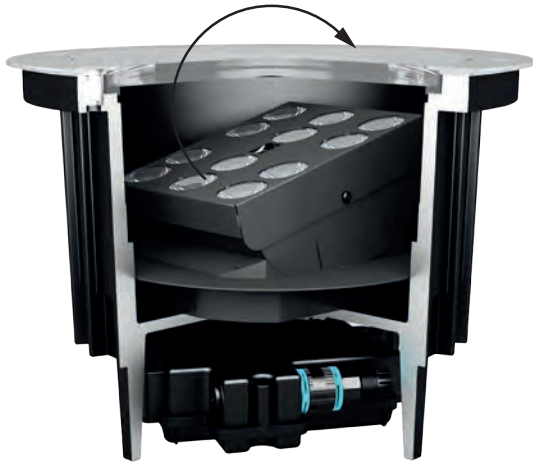

Gimbal optic

For precision lighting. A real projector given its high performance and the adjustability of the optical unit up to 40°.

05 Keplero Wall washer

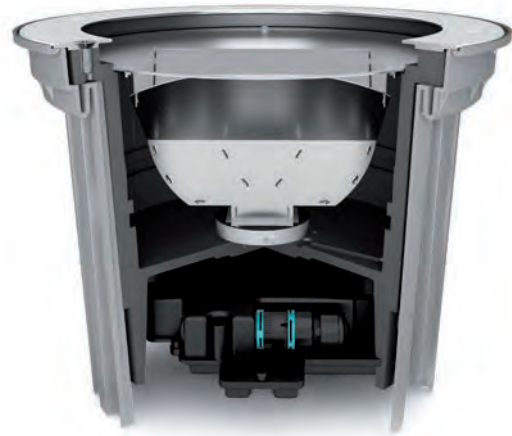

Wall washer Optical system to light vertical surfaces uniformly

An optical system composed of a reflector and a lens that can not only guarantee complete uniformity on vertical surfaces but also excellent light diffusion from very close to the floor.

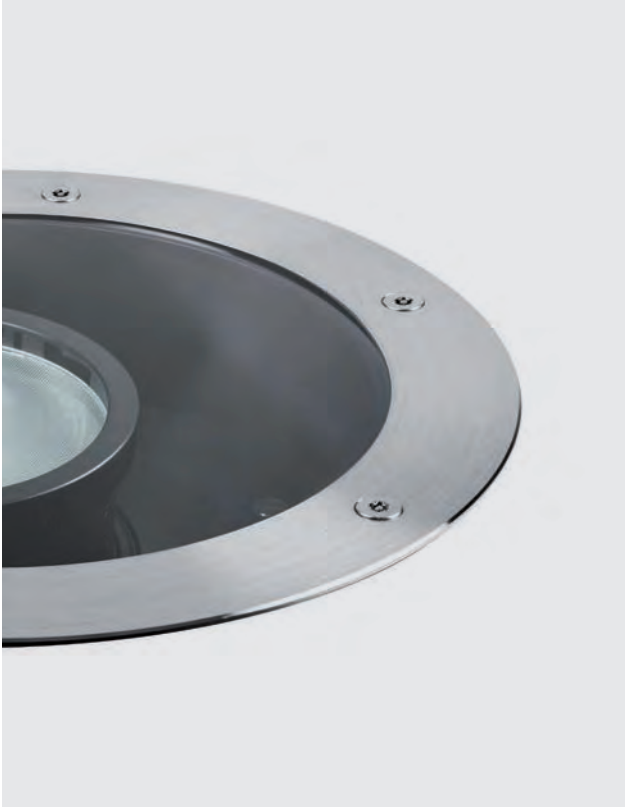

Brushed stainless steel ring finish

Installed flush or protruding by simply removing the frame from the nylon installation sleeve available as an accessory.

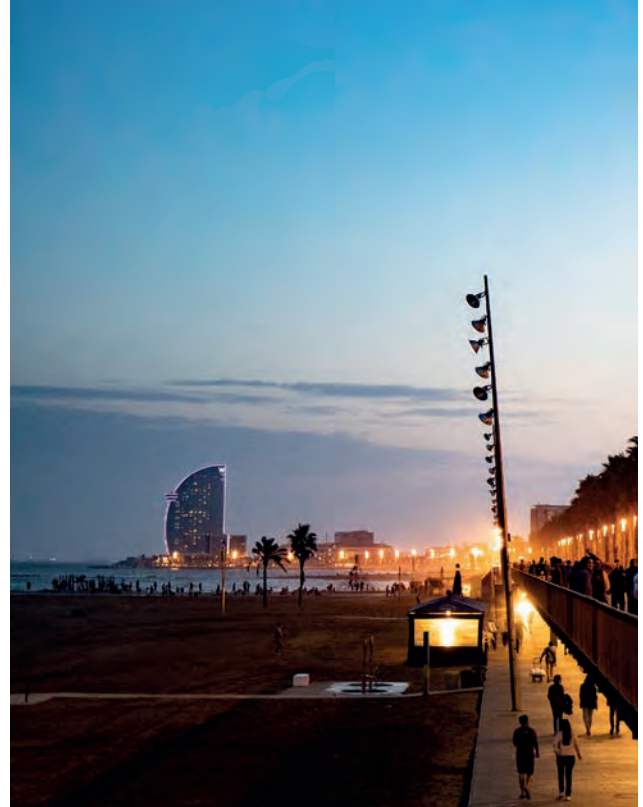

The cathoporesis treatment of KEPLERO

range makes it possible for installations of up to 1 metre away from the sea.

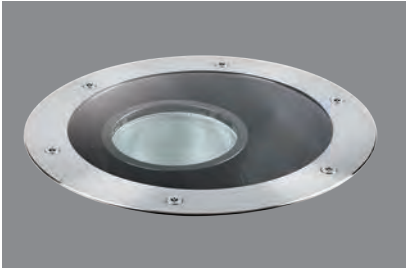

Zoom

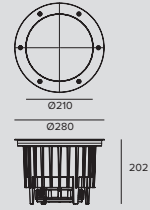

202

LED / 33W / SP, FL, MWFL, WFL



		3000K	H(m)	D(m)	E _{max} (lx)	
		Ra84		19°		
Fixture Power		36W	1	0.34	11460	
Source Flux		4550lm	2	0.67	2865	
Fixture Flux		1666lm	3	1.01	1273	
Efficacy		47lm/W	4	1.34	716	
TS782	Imax=2519cd/klm	Imax	11460cd	5	1.68	458

Driver	Colour	3000K	4000K
EL.		1E2386	1E2387

		3000K	H(m)	D(m)	E _{max} (lx)	
		Ra84		26°		
Fixture Power		36W	1	0.46	7939	
Source Flux		4550lm	2	0.93	1985	
Fixture Flux		2205lm	3	1.39	882	
Efficacy		62lm/W	4	1.85	496	
TS781	Imax=1745cd/klm	Imax	7939cd	5	2.31	318

		3000K	H(m)	D(m)	E _{max} (lx)	
		Ra84		64°		
Fixture Power		36W	1	1.25	2724	
Source Flux		4550lm	2	2.50	681	
Fixture Flux		2889lm	3	3.75	303	
Efficacy		81lm/W	4	5.00	170	
TS779	Imax=599cd/klm	Imax	2724cd	5	6.25	109

		3000K	H(m)	D(m)	E _{max} (lx)	
		Ra84		43°		
Fixture Power		36W	1	0.79	4579	
Source Flux		4550lm	2	1.57	1145	
Fixture Flux		2756lm	3	2.36	509	
Efficacy		77lm/W	4	3.14	286	
TS780	Imax=1006cd/klm	Imax	4579cd	5	3.93	183

Note

All lighting fixtures have to be completed with installation sleeves.

The projector can withstand temporary accidental immersion to a depth of 1.3 metres (max.1h) but is unsuitable for permanent underwater installation. IP69K complies with Standard DIN 40050-9.

All versions of the KEPLERO family meet all the requirements of EN 60598-2-13 standard regarding drive-over and walk-over performances. Low temperatures on the glass which characterises the LED range of fixtures make them suitable even for installation in "special areas", such as spaces for children.

Related codes

Sleeve



Code

1E2394

Grey nylon installation sleeve.
 The sleeve is pre-set for both flush or straight edge installation.
 Complete with dedicated cover cap for installations in concrete.
 Flush ring Ø 286 H.225.
 Straight edge ring Ø 271 H. 223.

KEPLERO

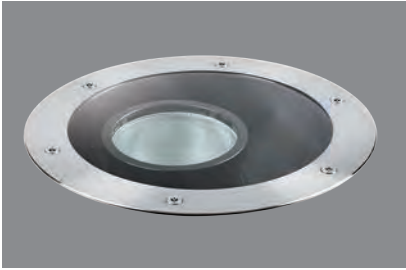

Zoom RGBW

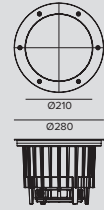

202

LED RGBW / 49W / SP, FL, MWFL, WFL



		H(m)	D(m)	E _{max} (lx)
			23*	
Fixture Power	20W	1	0.42	435
Source Flux	84lm	2	0.83	109
Fixture Flux	84lm	3	1.25	48
Efficacy	4lm/W	4	1.66	27
TS904	I _{max} =5165cd/klm	I _{max}	435cd	5
			2.08	17

Driver	Colour	Code
EL. DMX		1E2768

Note

Photometrics show the maximum emission values of fixtures.

All lighting fixtures have to be completed with installation sleeves.

The projector can withstand temporary accidental immersion to a depth of 1.3 metres (max.1h) but is unsuitable for permanent underwater installation. IP69K complies with Standard DIN 40050-9.

All versions of the KEPLERO family meet all the requirements of EN 60598-2-13 standard regarding drive-over and walk-over performances. Low temperatures on the glass make them suitable even for installation in "special areas", such as spaces for children.

Related codes

Sleeve

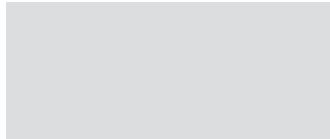

Code

1E2394

Grey nylon installation sleeve.

The sleeve is pre-set for both flush or straight edge installation.

Complete with dedicated cover cap for installations in concrete.

Flush ring Ø 286 H.225.

Straight edge ring Ø 271 H. 223.

Accessories

Filter

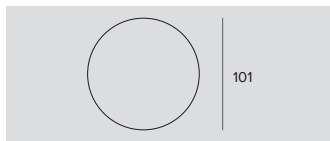

Filter	Ø	Code
Red	101	1T1700
Green	101	1T1701
Blue	101	1T1702
Yellow	101	1T1703
Magenta	101	1T1704

Flat glass interference chromatic filter.

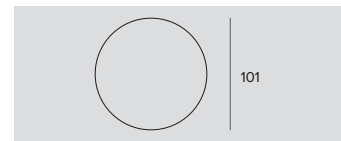

Ø	Code
101	1T1696

Flat striped glass blade light refractive filter.

This makes the beam take on an oval shape and when combined with spotlights, the light blade appears more prominent.

Shutter

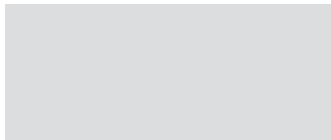

Colour	Code
●	1E2402

Half-moon shutter.

Grid

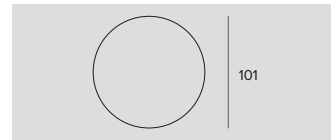

Ø	Code
101	1T1699

Anti-glare louver.
Black painted metal honeycomb structure.

Tool

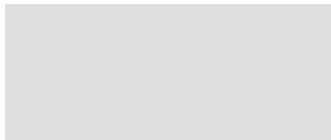

Code
1E2496

Metal handle for fixture removal

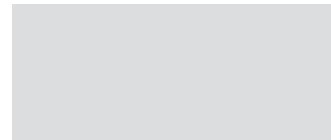

Code
1E2495

Features TORX HEAD, TX 30.

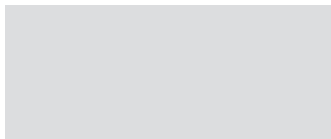

Code
1E0388

Sucker tool to raise the glass.

Connector

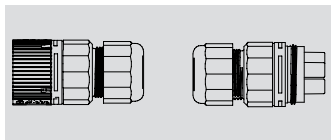

Code
1E2769

Connectors kit for 5 pole coaxial connections.
Only for white LED version.

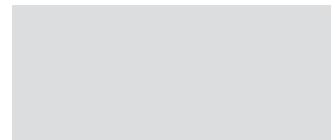

Code
1E2494

Non DALI looping connector.
1 IN - 3 OUT 4 poles max. wire section 2.5mm².
Cable diameter range from 8 to 12mm. IP68
Only for white LED version.

Connector

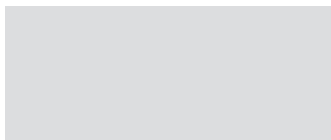

Code
1E3184

DMX connection.
Only for RGBW LED version.

Control systems

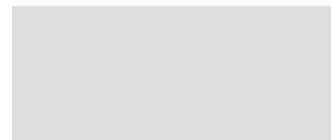

Code
1E2767

USB-RDM Programmer code.
DMX-RDM (Remote Device Management) address planner.
Used with the "RDM Targetti" software that can be downloaded for free from the Targetti website download section.
To be used with all RGBW products.

KEPLERO



Gimbal

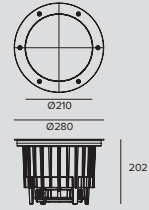

LED / 11W / NSP

	3000K	H(m)	D(m)	E _{max} (lx)
Ra80			9°	
Fixture Power	15W	1	0.15	20172
Source Flux	878lm	2	0.31	5043
Fixture Flux	718lm	3	0.46	2241
Efficacy	50lm/W	4	0.61	1261
TS776	I _{max} =22975cd/klm	I _{max}	20172cd	5 0.76 807

Driver	Colour	3000K	4000K
EL.		1E2388	1E2389

LED / 11W / FL

	3000K	H(m)	D(m)	E _{max} (lx)
Ra80			28°	
Fixture Power	15W	1	0.51	2508
Source Flux	878lm	2	1.01	627
Fixture Flux	636lm	3	1.52	279
Efficacy	44lm/W	4	2.02	157
TS777	I _{max} =2857cd/klm	I _{max}	2508cd	5 2.53 100

Driver	Colour	3000K	4000K
EL.		1E2390	1E2391

LED / 11W / FL RECTANGLE

	3000K	H(m)	D1(m)	D2(m)	E _{max} (lx)
Ra80			43°	30°	
Fixture Power	15W	1	0.79	0.54	1228
Source Flux	878lm	2	1.58	1.08	307
Fixture Flux	582lm	3	2.36	1.62	136
Efficacy	40lm/W	4	3.15	2.15	77
TS778	I _{max} =1398cd/klm	I _{max}	1228cd	5 3.94 2.69 49	

Driver	Colour	3000K	4000K
EL.		1E2392	1E2393

Note

All lighting fixtures have to be completed with installation sleeves.

The projector can withstand temporary accidental immersion to a depth of 1.3 metres (max.1h) but is unsuitable for permanent underwater installation. IP69K complies with Standard DIN 40050-9.

All versions of the KEPLERO family meet all the requirements of EN 60598-2-13 standard regarding drive-over and walk-over performances. Low temperatures on the glass which characterises the LED range of fixtures make them suitable even for installation in "special areas", such as spaces for children.

Related codes

Sleeve

Code
1E2394

Grey nylon installation sleeve.
The sleeve is pre-set for both flush or straight edge installation.
Complete with dedicated cover cap for installations in concrete.
Flush ring Ø 286 H.225.
Straight edge ring Ø 271 H. 223.

Accessories

Filter



Filter	Ø	Code
Red	101	1T1700
Green	101	1T1701
Blue	101	1T1702
Yellow	101	1T1703
Magenta	101	1T1704

Flat glass interference chromatic filter.

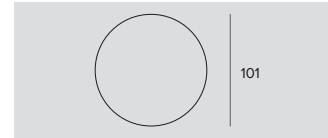

Ø	Code
101	1T1696

Flat striped glass blade light refractive filter.
This makes the beam take on an oval shape and when combined with spotlights, the light blade appears more prominent.

Grid

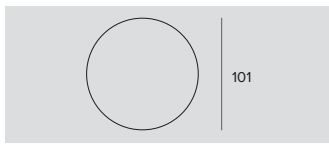

Ø	Code
101	1T1699

Anti-glare louver.
Black painted metal honeycomb structure.

Shutter

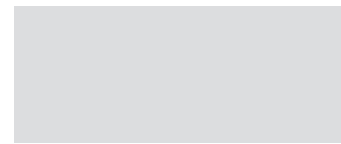

Colour	Code
●	1E2402

Half-moon shutter.

Tool

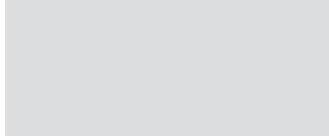

Code
1E2496

Metal handle for fixture removal

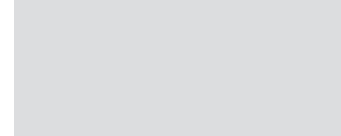

Code
1E2495

Features TORX HEAD, TX 30.



Code
1E0388

Sucker tool to raise the glass.

Connector

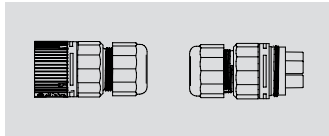

Code
1E2769

Connectors kit for 5 pole coaxial connections.

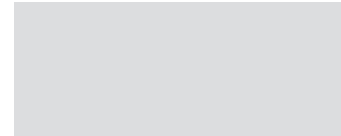

Code
1E2494

Non DALI looping connector.
1 IN - 3 OUT 4 poles max. wire section 2.5mm².
Cable diameter range from 8 to 12mm.
IP68

KEPLERO



Gimbal HP



202

LED / 33W / NSP



	3000K	H(m)	D(m)	E _{max} (lx)
Ra84			8°	
Fixture Power	37W	1	0.14	78598
Source Flux	2791lm	2	0.29	19650
Fixture Flux	2373lm	3	0.43	8733
Efficacy	64lm/W	4	0.57	4912
TS986	I _{max} =28161cd/klm	I _{max}	78598cd	5 0.72 3144

Driver	Colour	3000K	4000K
EL.		1E3050	1E3053

LED / 33W / SP



	3000K	H(m)	D(m)	E _{max} (lx)
Ra84			18°	
Fixture Power	37W	1	0.32	18947
Source Flux	2791lm	2	0.63	4737
Fixture Flux	2205lm	3	0.95	2105
Efficacy	60lm/W	4	1.27	1184
TS987	I _{max} =6789cd/klm	I _{max}	18947cd	5 1.58 758

Driver	Colour	3000K	4000K
EL.		1E3051	1E3054

LED / 33W / FL



	3000K	H(m)	D(m)	E _{max} (lx)
Ra84			30°	
Fixture Power	37W	1	0.53	8160
Source Flux	2791lm	2	1.06	2040
Fixture Flux	2149lm	3	1.59	907
Efficacy	58lm/W	4	2.12	510
TS988	I _{max} =2924cd/klm	I _{max}	8160cd	5 2.65 326

Driver	Colour	3000K	4000K
EL.		1E3052	1E3055

Note

All lighting fixtures have to be completed with installation sleeves.

The projector can withstand temporary accidental immersion to a depth of 1.3 metres (max.1h) but is unsuitable for permanent underwater installation. IP69K complies with Standard DIN 40050-9.

All versions of the KEPLERO family meet all the requirements of EN 60598-2-13 standard regarding drive-over and walk-over performances. Low temperatures on the glass make them suitable even for installation in "special areas", such as spaces for children.

Related codes

Sleeve

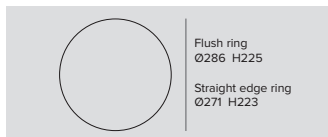

Code

1E2394

Grey nylon installation sleeve.

The sleeve is pre-set for both flush or straight edge installation. Complete with dedicated cover cap for installations in concrete.

Flush ring Ø 286 H.225.

Straight edge ring Ø 271 H. 223.

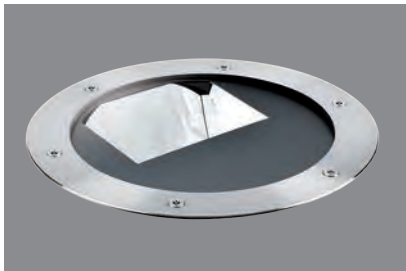

Wall Washer

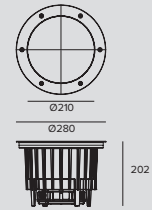

LED / 33W / WALL WASHER



	3000K	H(m)	D1(m)	D2(m)	E _{max} (lx)		
Ra84			106*	66*			
Fixture Power	36W	1	2.68	1.61	1355		
Source Flux	4550lm	2	5.36	3.22	339		
Fixture Flux	2318lm	3	8.04	4.84	151		
Efficacy	65lm/W	4	10.71	6.45	85		
TS853	I _{max} =393cd/klm	I _{max}	1790cd	5	13.39	8.06	54

Driver	Colour	3000K	4000K
EL.	●	1E2561	1E2562

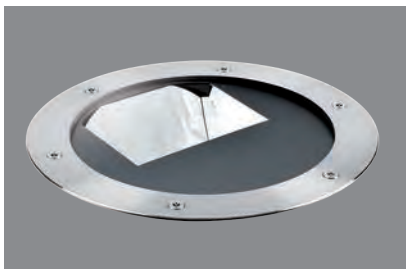

Wall Washer RGBW

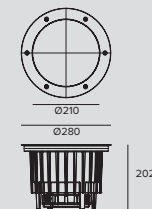

LED RGBW / 49W / WALL WASHER



	H(m)	D1(m)	D2(m)	E _{max} (lx)			
	114*	75*					
Fixture Power	20W	1	3.10	2.07	47		
Source Flux	113lm	2	6.19	4.14	12		
Fixture Flux	113lm	3	9.29	6.21	5		
Efficacy	6lm/W	4	12.39	8.29	3		
TS1026	I _{max} =550cd/klm	I _{max}	62cd	5	15.48	10.36	2

Driver	Colour	Code
EL. DMX	●	1E3123

Note

Photometrics show the maximum emission values of fixtures.

All lighting fixtures have to be completed with installation sleeves.

The projector can withstand temporary accidental immersion to a depth of 1.3 metres (max.1h) but is unsuitable for permanent underwater installation. IP69K complies with Standard DIN 40050-9.

All versions of the KEPLERO family meet all the requirements of EN 60598-2-13 standard regarding drive-over and walk-over performances. Low temperatures on the glass make them suitable even for installation in "special areas", such as spaces for children.

Related codes

Sleeve

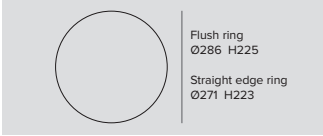
Flush ring
Ø286 H225

Straight edge ring
Ø271 H223

Code
1E2394

Grey nylon installation sleeve.

The sleeve is pre-set for both flush or straight edge installation. Complete with dedicated cover cap for installations in concrete.







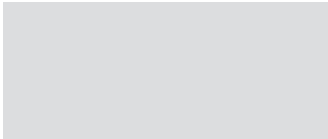

Flush ring Ø 286 H.225.

Straight edge ring Ø 271 H. 223.

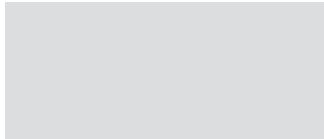
Inground recessed

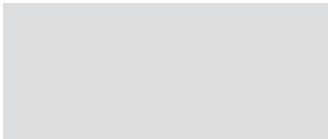
KEPLERO

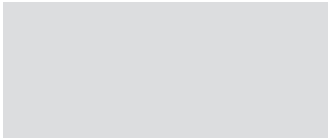
Accessories

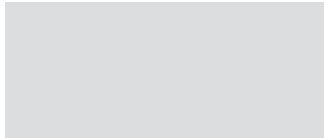
Tool	
	
	Code
	1E2496
Metal handle for fixture removal	
	
	Code
	1E2495
Features TORX HEAD, TX 30.	
	
	Code
	1E0388
Sucker tool to raise the glass.	
Connector	
	
	Code
	1E3184
DMX connection.	
Control systems	
	
	Code
	1E2767
USB-RDM Programmer code. DMX-RDM (Remote Device Management) address planner. Used with the "RDM Targetti" software that can be downloaded for free from the Targetti website download section. To be used with all RGBW products.	



Mini Zoom

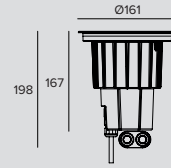

LED / 12W / ZOOM / SP, FL, MWFL, WFL 1.1 IP66 IP67 IP68 IK10 ENEC

		3000K	H(m)	D(m)	E _{max} (lx)
Ra84				16°	
Fixture Power	14W	1	0.28	5715	
Source Flux	1775lm	2	0.55	1429	
Fixture Flux	615lm	3	0.83	635	
Efficacy	46lm/W	4	1.10	357	
TS815	I _{max} =3220cd/klm	I _{max}	5	1.38	229

Insulation	Power supply	Driver	Colour	3000K	4000K
CLASS 2	220-240Vac	EL.	●	1E2497	1E2498
CLASS 3	48Vdc		●	1E2499	1E2500

		3000K	H(m)	D(m)	E _{max} (lx)
Ra84				33°	
Fixture Power	14W	1	0.58	2608	
Source Flux	1775lm	2	1.17	652	
Fixture Flux	809lm	3	1.75	290	
Efficacy	60lm/W	4	2.33	163	
TS816	I _{max} =1469cd/klm	I _{max}	5	2.92	104

		3000K	H(m)	D(m)	E _{max} (lx)
Ra84				53°	
Fixture Power	14W	1	0.99	1536	
Source Flux	1775lm	2	1.98	384	
Fixture Flux	1045lm	3	2.97	171	
Efficacy	77lm/W	4	3.95	96	
TS817	I _{max} =866cd/klm	I _{max}	5	4.94	61

		3000K	H(m)	D(m)	E _{max} (lx)
Ra84				61°	
Fixture Power	14W	1	1.18	1102	
Source Flux	1775lm	2	2.37	276	
Fixture Flux	1127lm	3	3.55	122	
Efficacy	83lm/W	4	4.74	69	
TS818	I _{max} =621cd/klm	I _{max}	5	5.92	44

Note

All lighting fixtures have to be completed with ring and installation sleeves.

The projector can withstand temporary accidental immersion to a depth of 1.3 metres (max.1h) but is unsuitable for permanent underwater installation.

All versions of the KEPLERO family meet all the requirements of EN 60598-2-13 standard regarding drive-over and walk-over performances. Low temperatures on the glass which characterises the LED range of fixtures make them suitable even for installation in "special areas", such as spaces for children.

Related codes

Sleeve



Ø	H	Code
166	200	1E2521

Installation sleeve.
Grey Nylon casing.
Round and square ring for semi-flush installation. Only round ring for flush installation.

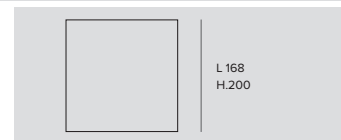

L	H	Code
168	200	1E2522

Installation sleeve.
Grey Nylon casing and stainless steel profile.
Square ring for flush installation.

KEPLERO

Decorative Ring

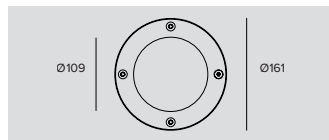

Code

1E2525

Brushed stainless steel (AISI316L), ultra flat, bevelled edge decorative ring.
10mm thick extra clear protective glass.
Silicone gasket.
Anti-theft Torx screws.
The ring can be supplied with a special anti-slip protective glass for public pedestrian areas on request for minimum quantities.

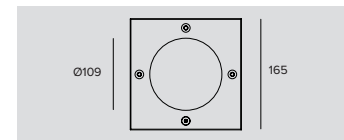

Code

1E2526

Brushed stainless steel (AISI316L), ultra flat square decorative ring.
10mm thick extra clear protective glass.
Silicone gasket.
Anti-theft Torx screws.
The ring can be supplied with a special anti-slip protective glass for public pedestrian areas on request for minimum quantities.

Power Supply

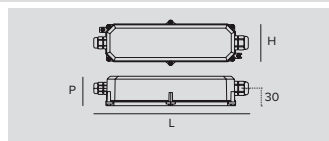

Code

1E2320

Electronic driver 70W, LxHxP=225x51x65mm, input voltage: 220-240V 50/60Hz, 48V-DC, IP67.
Cable length 1 meter (IN-OUT).

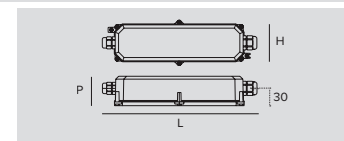

Code

1E2321

Electronic driver 150W, LxHxP=225x51x65mm, input voltage: 220-240V 50/60Hz, 48V-DC, IP67.
Cable length 1 meter (IN-OUT).

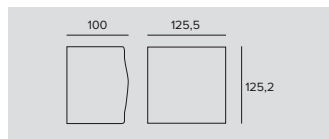

Code

1E2533

Electronic driver 240W, LxHxP=125x100x125mm, input voltage: 220V-240V 50/60Hz, 48V-DC, IP20.
Without cable.
Complete with connector.
Electrical panel power supply.
DIN RAIL power supply.

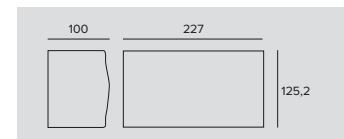

Code

1E2323

Electronic driver 480W, LxHxP=227x100x125mm, input voltage: 220-240V 50/60Hz, 48V-DC, IP20.
Without cable.
Complete with connector.
Electrical panel power supply - DIN RAIL power supply.



Mini Gimbal

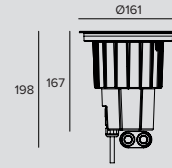

LED / 8,4W / GIMBAL / SP

	3000K	H(m)	D(m)	Emax(lx)		
Ra80			11°			
Fixture Power	11W	1	0.19	11401		
Source Flux	768lm	2	0.38	2850		
Fixture Flux	592lm	3	0.57	1267		
Efficacy	56lm/W	4	0.77	713		
TS819	Imax=14845cd/klm	Imax	11401cd	5	0.96	456

Insulation	Power supply	Driver	Colour	3000K	4000K
CLASS 2	220-240Vac	EL.	●	1E2501	1E2502
CLASS 3	48Vdc		●	1E2505	1E2506

LED / 8,4W / GIMBAL / FL

	3000K	H(m)	D1(m)	D2(m)	Emax(lx)		
Ra80			32°	30°			
Fixture Power	11W	1	0.57	0.54	2112		
Source Flux	768lm	2	1.15	1.09	528		
Fixture Flux	568lm	3	1.72	1.63	235		
Efficacy	54lm/W	4	2.29	2.17	132		
TS820	Imax=2750cd/klm	Imax	2112cd	5	2.87	2.72	84

Insulation	Power supply	Driver	Colour	3000K	4000K
CLASS 2	220-240Vac	EL.	●	1E2503	1E2504
CLASS 3	48Vdc		●	1E2507	1E2508

Note

All lighting fixtures have to be completed with ring and installation sleeves.

The projector can withstand temporary accidental immersion to a depth of 1.3 metres (max.1h) but is unsuitable for permanent underwater installation. All versions of the KEPLERO family meet all the requirements of EN 60598-2-13 standard regarding drive-over and walk-over performances. Low temperatures on the glass which characterises the LED range of fixtures make them suitable even for installation in "special areas", such as spaces for children.

Related codes

Sleeve

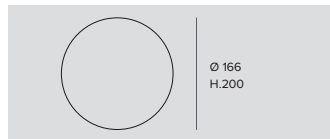

Ø	H	Code
166	200	1E2521

Installation sleeve.
Grey Nylon casing.
Round and square ring for semi-flush installation. Only round ring for flush installation.

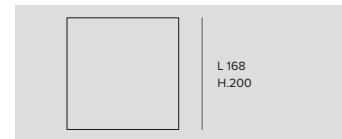

L	H	Code
168	200	1E2522

Installation sleeve.
Grey Nylon casing and stainless steel profile.
Square ring for flush installation.

KEPLERO

Decorative Ring

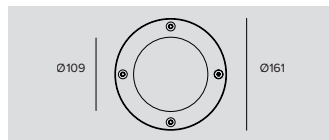

Code

1E2525

Brushed stainless steel (AISI316L), ultra flat, bevelled edge decorative ring.
10mm thick extra clear protective glass.
Silicone gasket.
Anti-theft Torx screws.
The ring can be supplied with a special anti-slip protective glass for public pedestrian areas on request for minimum quantities.

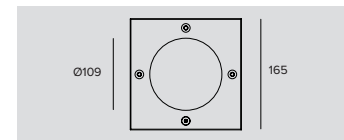

Code

1E2526

Brushed stainless steel (AISI316L), ultra flat square decorative ring.
10mm thick extra clear protective glass.
Silicone gasket.
Anti-theft Torx screws.
The ring can be supplied with a special anti-slip protective glass for public pedestrian areas on request for minimum quantities.

Power Supply

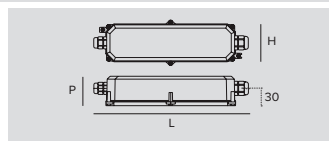

Code

1E2320

Electronic driver 70W, LxHxP=225x51x65mm, input voltage: 220-240V 50/60Hz, 48V-DC, IP67.
Cable length 1 meter (IN-OUT).

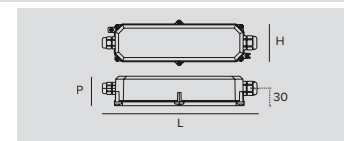

Code

1E2321

Electronic driver 150W, LxHxP=225x51x65mm, input voltage: 220-240V 50/60Hz, 48V-DC, IP67.
Cable length 1 meter (IN-OUT).

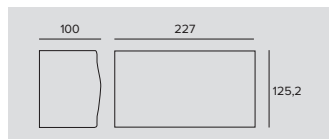

Code

1E2323

Electronic driver 480W, LxHxP=227x100x125mm, input voltage: 220-240V 50/60Hz, 48V-DC, IP20.
Without cable.
Complete with connector.
Electrical panel power supply - DIN RAIL power supply.

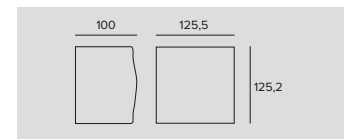

Code

1E2533

Electronic driver 240W, LxHxP=125x100x125mm, input voltage: 220V-240V 50/60Hz, 48V-DC, IP20.
Without cable.
Complete with connector.
Electrical panel power supply.
DIN RAIL power supply.



Mini High Efficacy

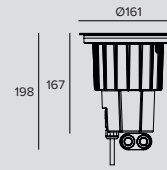

LED / 12W / SP						1.1	IP66	IP67	IP68	IK10	ENEC	RoHS	REACH
	3000K	H(m)	D(m)	Emax(lx)		Insulation	Power supply	Driver	Colour	3000K	4000K		
	Ra84			11°		CLASS 2	220-240Vac	EL.	●	1E2509	1E2510		
	Fixture Power	14W	1	0.20	17736	CLASS 3	48Vdc		●	1E2515	1E2516		
	Source Flux	1775lm	2	0.39	4434								
	Fixture Flux	1403lm	3	0.59	1971								
	Efficacy	104lm/W	4	0.79	1109								
TS821	Imax=9992cd/klm	Imax	17736cd	5	0.99	709							

LED / 12W / FL						1.1	IP66	IP67	IP68	IK10	ENEC	RoHS	REACH
	3000K	H(m)	D(m)	Emax(lx)		Insulation	Power supply	Driver	Colour	3000K	4000K		
	Ra84			18°		CLASS 2	220-240Vac	EL.	●	1E2511	1E2512		
	Fixture Power	14W	1	0.31	7969	CLASS 3	48Vdc		●	1E2517	1E2518		
	Source Flux	1775lm	2	0.63	1992								
	Fixture Flux	1397lm	3	0.94	885								
	Efficacy	104lm/W	4	1.25	498								
TS822	Imax=4490cd/klm	Imax	7969cd	5	1.57	319							

LED / 12W / MWFL						1.1	IP66	IP67	IP68	IK10	ENEC	RoHS	REACH
	3000K	H(m)	D(m)	Emax(lx)		Insulation	Power supply	Driver	Colour	3000K	4000K		
	Ra84			40°		CLASS 2	220-240Vac	EL.	●	1E2513	1E2514		
	Fixture Power	14W	1	0.73	2861	CLASS 3	48Vdc		●	1E2519	1E2520		
	Source Flux	1775lm	2	1.47	715								
	Fixture Flux	1384lm	3	2.20	318								
	Efficacy	102lm/W	4	2.93	179								
TS823	Imax=1624cd/klm	Imax	2882cd	5	3.67	114							

Note

All lighting fixtures have to be completed with ring and installation sleeves.

The projector can withstand temporary accidental immersion to a depth of 1.3 metres (max.1h) but is unsuitable for permanent underwater installation.

All versions of the KEPLERO family meet all the requirements of EN 60598-2-13 standard regarding drive-over and walk-over performances. Low temperatures on the glass which characterises the LED range of fixtures make them suitable even for installation in "special areas", such as spaces for children.

Related codes

Sleeve			
Ø	H	L	H
166	200	168	200
Code		Code	
1E2521		1E2522	

Installation sleeve.
Grey Nylon casing.
Round and square ring for semi-flush installation. Only round ring for flush installation.

Installation sleeve.
Grey Nylon casing and stainless steel profile.
Square ring for flush installation.

KEPLERO

Decorative Ring

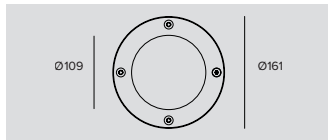

Code

1E2525

Brushed stainless steel (AISI316L), ultra flat, bevelled edge decorative ring.
10mm thick extra clear protective glass.
Silicone gasket.
Anti-theft Torx screws.
The ring can be supplied with a special anti-slip protective glass for public pedestrian areas on request for minimum quantities.

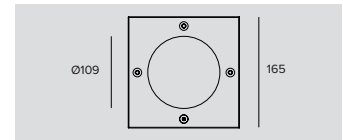

Code

1E2526

Brushed stainless steel (AISI316L), ultra flat square decorative ring.
10mm thick extra clear protective glass.
Silicone gasket.
Anti-theft Torx screws.
The ring can be supplied with a special anti-slip protective glass for public pedestrian areas on request for minimum quantities.

Power Supply

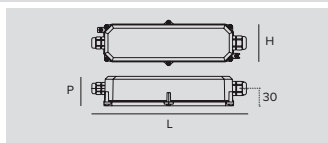

Code

1E2320

Electronic driver 70W, LxHxP=225x51x65mm, input voltage: 220-240V 50/60Hz, 48V-DC, IP67.
Cable length 1 meter (IN-OUT).

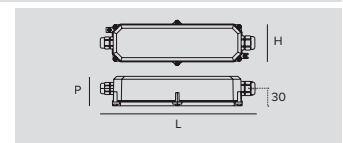

Code

1E2321

Electronic driver 150W, LxHxP=225x51x65mm, input voltage: 220-240V 50/60Hz, 48V-DC, IP67.
Cable length 1 meter (IN-OUT).

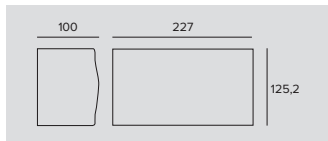

Code

1E2323

Electronic driver 480W, LxHxP=227x100x125mm, input voltage: 220-240V 50/60Hz, 48V-DC, IP20.
Without cable.
Complete with connector.
Electrical panel power supply - DIN RAIL power supply.

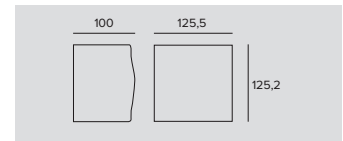

Code

1E2533

Electronic driver 240W, LxHxP=125x100x125mm, input voltage: 220V-240V 50/60Hz, 48V-DC, IP20.
Without cable.
Complete with connector.
Electrical panel power supply.
DIN RAIL power supply.

Accessories

Filter

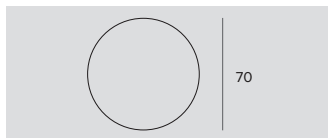

Filter	Ø	Code
Red	70	1T1712
Green	70	1T1713
Blue	70	1T1714
Yellow	70	1T1715
Magenta	70	1T1716

Flat glass interference chromatic filter.
To be completed with an additional holder ring.

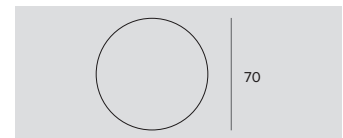

Ø	Code
70	1T1708

Flat striped glass blade light refractive filter.
This makes the beam take on an oval shape and when combined with spotlights, the light blade appears more prominent.
To be completed with an additional holder ring.

Grid

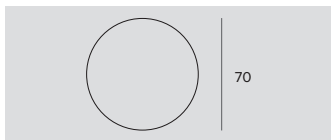

Ø Code
70 **1T1711**

Anti-glare louver.
Black painted metal honeycomb structure.
To be completed with an additional holder ring.

Shutter

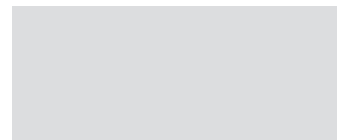

Code
1E2523

Black half-moon shutter.

Holder Ring

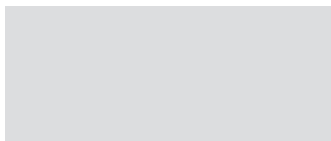

Code
1T3727

Transparent polycarbonate accessory holder ring.

Tool

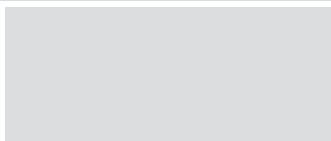

Code
1E2495

Features TORX HEAD, TX 30.

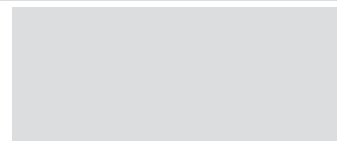

Code
1E2524

Metal handle for fixture removal

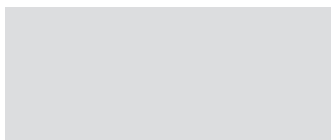

Code
1E0388

Sucker tool to raise the glass.

Connector

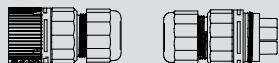

Code
1E2769

Connectors kit for 5 pole coaxial connections.
Remote mounting for the following products: Jupiter, Jupiter Mini, Saturn, Saturn Mini, and Led.Y.

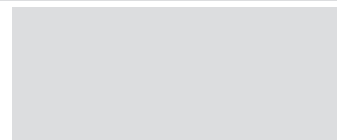

Code
1E2494

Non DALI looping connector.
1 IN - 3 OUT 4 poles max. wire section 2.5mm².
Cable diameter range from 8 to 12mm.
IP68

KEPLERO

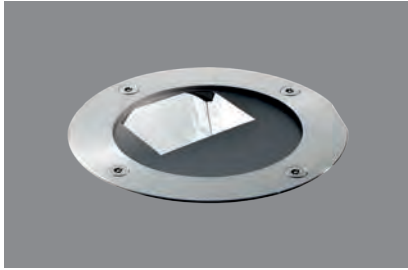

Mini Wall Washer

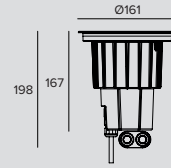

LED / 12W / WALL WASHER



	3000K	H(m)	D1(m)	D2(m)	E _{max} (lx)		
Ra84			34*	84*			
Fixture Power	14W	1	0.70	1.87	877		
Source Flux	1852lm	2	1.40	3.75	219		
Fixture Flux	933lm	3	2.10	5.62	97		
Efficacy	67lm/W	4	2.81	7.49	55		
TS1152	I _{max} =537cd/klm	I _{max}	994cd	5	3.51	9.36	35

Insulation	Power supply	Driver	Colour	3000K	4000K
CLASS 2	220-240Vac	EL.	●	1E3517	1E3518
CLASS 3	48Vdc		●	1E3519	1E3520

Note

All lighting fixtures have to be completed with ring and installation sleeves.

The projector can withstand temporary accidental immersion to a depth of 1.3 metres (max.1h) but is unsuitable for permanent underwater installation.

All versions of the KEPLERO family meet all the requirements of EN 60598-2-13 standard regarding drive-over and walk-over performances. Low temperatures on the glass which characterises the LED range of fixtures make them suitable even for installation in "special areas", such as spaces for children.

Related codes

Sleeve



Ø	H	Code
166	200	1E2521

Installation sleeve.
Grey Nylon casing.
Round and square ring for semi-flush installation. Only round ring for flush installation.

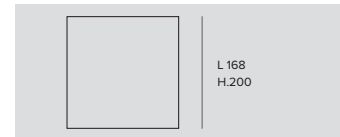

L	H	Code
168	200	1E2522

Installation sleeve.
Grey Nylon casing and stainless steel profile.
Square ring for flush installation.

Decorative Ring

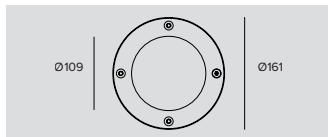

Code
1E2525

Brushed stainless steel (AISI316L), ultra flat, bevelled edge decorative ring.
10mm thick extra clear protective glass.
Silicone gasket.
Anti-theft Torx screws.
The ring can be supplied with a special anti-slip protective glass for public pedestrian areas on request for minimum quantities.

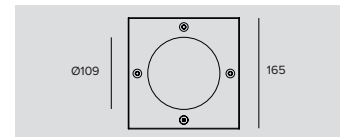

Code
1E2526

Brushed stainless steel (AISI316L), ultra flat square decorative ring.
10mm thick extra clear protective glass.
Silicone gasket.
Anti-theft Torx screws.
The ring can be supplied with a special anti-slip protective glass for public pedestrian areas on request for minimum quantities.

Power Supply

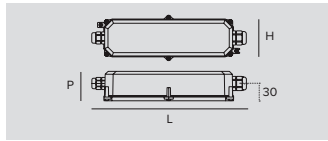

Code

1E2320

Electronic driver 70W, LxHxP=225x51x65mm, input voltage: 220-240V 50/60Hz, 48V-DC, IP67.
Cable length 1 meter (IN-OUT).

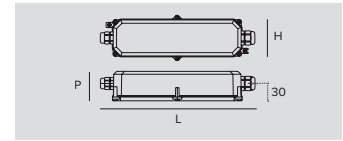

Code

1E2321

Electronic driver 150W, LxHxP=225x51x65mm, input voltage: 220-240V 50/60Hz, 48V-DC, IP67.
Cable length 1 meter (IN-OUT).

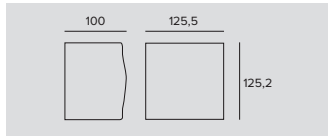

Code

1E2533

Electronic driver 240W, LxHxP=125x100x125mm, input voltage: 220V-240V 50/60Hz, 48V-DC, IP20.
Without cable.
Complete with connector.
Electrical panel power supply.
DIN RAIL power supply.

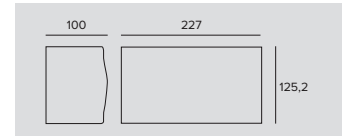

Code

1E2323

Electronic driver 480W, LxHxP=227x100x125mm, input voltage: 220-240V 50/60Hz, 48V-DC, IP20.
Without cable.
Complete with connector.
Electrical panel power supply - DIN RAIL power supply.

Accessories

Tool



Code

1E2495

Features TORX HEAD, TX 30.



Code

1E2524

Metal handle for fixture removal



Code

1E0388

Sucker tool to raise the glass.

Connector

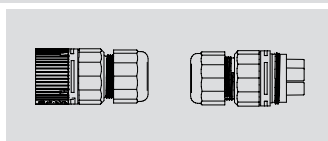

Code

1E2769

Connectors kit for 5 pole coaxial connections.



Code

1E2494

Non DALI looping connector.
1 IN - 3 OUT 4 poles max. wire section 2.5mm².
Cable diameter range from 8 to 12mm.
IP68

TITANO

GENERAL INFO

Semi-recessed fixture for grazing light effect.
ø169mm

LED

LED Emitter multichip
From 47lm to 181lm
3000K – 4000K
Ra80 – Ra83

PRODUCT EFFICACY

Unitil 106lm/W

OPTICS

One-emission 106°
Double-emission 106°+106°
Pluri-emission 4x62°

POWER SUPPLY

Electronic

MATERIAL

Stainless steel body.
Painted anodised aluminium ring and cover.

Grazing light effect inground fixture with a light that can be projected in one, two or more directions. The vertical angle is controlled by the lens to produce a glare-free effect which is highly effective on horizontal surfaces.

They meet all the requirements of standard EN 60598-2-13 regarding vehicle and pedestrian use and are therefore ideal for lighting all the areas provided for by the regulations, such as car parks, pedestrian zones and other designated areas

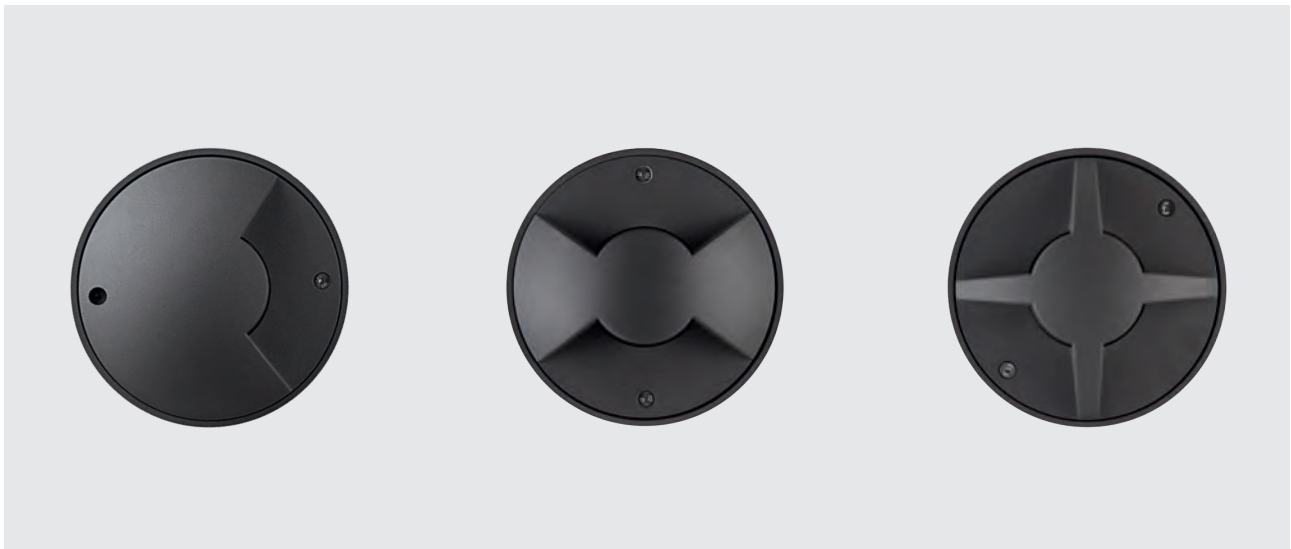



LED

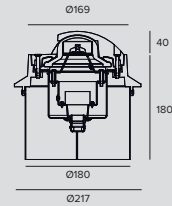

LED / 5W / MONO-DIRECTIONAL EMISSION

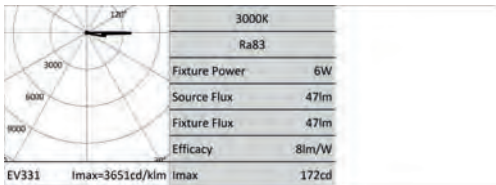

Driver	Colour	3000K	4000K
EL.	●	1E2770	1E2771

LED / 5W / BI-DIRECTIONAL EMISSION

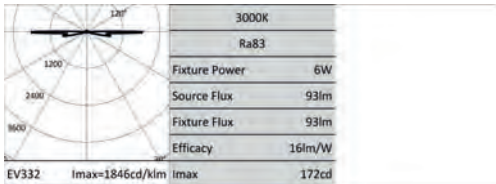

Driver	Colour	3000K	4000K
EL.	●	1E2772	1E2773

LED / 5W / MULTIDIRECTIONAL

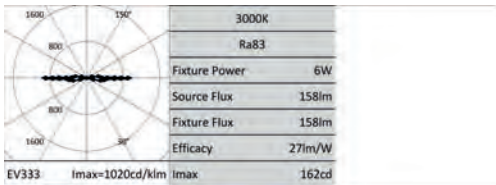

Driver	Colour	3000K	4000K
EL.	●	1E2774	1E2775

Accessories

Connector

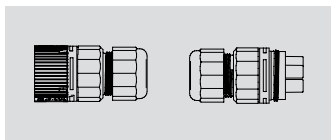

Code
1E2769

Connectors kit for 5 pole coaxial connections.



Code
1E2494

Non DALI looping connector.
1 IN - 3 OUT 4 poles max. wire section 2.5mm².
Cable diameter range from 8 to 12mm.
IP68

JUPITER

GENERAL INFO

Miniaturised recessed fixture
ø80mm - ø50mm

LED

Chip on board
From 353lm to 1251lm
3000K – 4000K
Ra84

PRODUCT EFFICACY

Up to 101lm/W

OPTICS

SP – FL – WFL

POWER SUPPLY

Electronic – DALI – 1-10V
Casambi control: the DALI version is fitted with special accessories.

MATERIAL

Anodised polished aluminium body. Polished stainless steel front ring.

This fixture has a lenticular type optic that makes it possible to obtain defined, precise beams.

It has no visible screws, the ring is flared and it connects smoothly to the floor avoiding treacherous steps especially when installed in environments such as SPAs or around swimming pools, ensured by the 24V power supply system. It is easy to install and has a minimal installation depth.

There are various versions available: drive over and walk over in both diameters. The drive over versions also have solutions equipped with anti-glare grills or asymmetrical screens.

Also available in a projector version.





Studio Ceri

Architect
Studio Ceri

Photographer
Officine
Fotografiche

Country
Prato - Italy

JUPITER



Walk-over

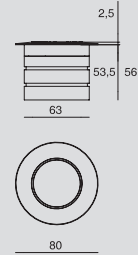

LED / 9W / SP

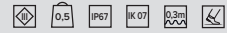

		3000K	H(m)	D(m)	E _{max} (lx)	
		Ra84		18°		
Fixture Power	10W	1	0.32	5028		
Source Flux	1213lm	2	0.65	1257		
Fixture Flux	958lm	3	0.97	559		
Efficacy	96lm/W	4	1.30	314		
TS1045	I _{max} =4145cd/klm	I _{max}	5028cd	5	1.62	201

Power supply	Colour	3000K	4000K
24Vdc	●	1E3128	1E3129

LED / 9W / FL

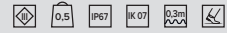

		3000K	H(m)	D(m)	E _{max} (lx)	
		Ra84		34°		
Fixture Power	10W	1	0.62	2069		
Source Flux	1213lm	2	1.23	517		
Fixture Flux	979lm	3	1.85	230		
Efficacy	98lm/W	4	2.47	129		
TS1046	I _{max} =1705cd/klm	I _{max}	2069cd	5	3.08	83

Power supply	Colour	3000K	4000K
24Vdc	●	1E3130	1E3131

LED / 9W / WFL

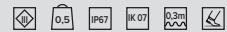

		3000K	H(m)	D(m)	E _{max} (lx)	
		Ra84		57°		
Fixture Power	10W	1	1.08	981		
Source Flux	1213lm	2	2.16	245		
Fixture Flux	961lm	3	3.25	109		
Efficacy	96lm/W	4	4.33	61		
TS1047	I _{max} =808cd/klm	I _{max}	981cd	5	5.41	39

Power supply	Colour	3000K	4000K
24Vdc	●	1E3132	1E3133



Driver-over

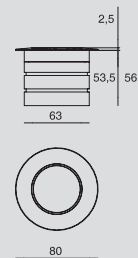

LED / 5.5W / SP



		3000K	H(m)	D1(m)	D2(m)	E _{max} (lx)	
		Ra84		19°	19°		
Fixture Power	6W	1	0.34	0.34	2850		
Source Flux	853lm	2	0.68	0.68	713		
Fixture Flux	579lm	3	1.01	1.02	317		
Efficacy	105lm/W	4	1.35	1.36	178		
TS1210	I _{max} =3341cd/klm	I _{max}	2850cd	5	1.69	1.70	114

Power supply	Colour	2700K	3000K	4000K
24Vdc	●	1E3451	1E3454	1E3457

LED / 5.5W / FL



		3000K	H(m)	D1(m)	D2(m)	E _{max} (lx)	
Ra84				43°	43°		
Fixture Power	6W	1	0.79	0.78	690		
Source Flux	927lm	2	1.57	1.56	172		
Fixture Flux	466lm	3	2.36	2.35	77		
Efficacy	80lm/W	4	3.15	3.13	43		
TS1164	I _{max} =746cd/klm	I _{max}	691cd	5	3.93	3.91	28

Power supply	Colour	2700K	3000K	4000K
24Vdc		1E3452	1E3455	1E3458

LED / 5.5W / WFL



		3000K	H(m)	D(m)	E _{max} (lx)	
Ra84				57°		
Fixture Power	6W	1	1.08	588		
Source Flux	853lm	2	2.15	147		
Fixture Flux	581lm	3	3.23	65		
Efficacy	106lm/W	4	4.30	37		
TS1211	I _{max} =690cd/klm	I _{max}	589cd	5	5.38	24

Power supply	Colour	2700K	3000K	4000K
24Vdc		1E3453	1E3456	1E3459

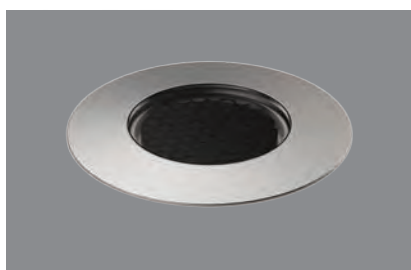

Driver-over with grid

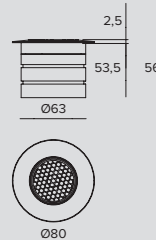

LED / 5.5W / SP



		3000K	H(m)	D(m)	E _{max} (lx)	
Ra84				21°		
Fixture Power	6W	1	0.37	2042		
Source Flux	927lm	2	0.74	511		
Fixture Flux	408lm	3	1.11	227		
Efficacy	70lm/W	4	1.48	128		
TS1154	I _{max} =2203cd/klm	I _{max}	2042cd	5	1.85	82

Power supply	Colour	2700K	3000K	4000K
24Vdc		1E3471	1E3474	1E3477

LED / 5.5W / FL



		3000K	H(m)	D1(m)	D2(m)	E _{max} (lx)	
Ra84				35°	34°		
Fixture Power	6W	1	0.63	0.60	861		
Source Flux	927lm	2	1.26	1.21	215		
Fixture Flux	376lm	3	1.89	1.81	96		
Efficacy	64lm/W	4	2.52	2.41	54		
TS1163	I _{max} =928cd/klm	I _{max}	861cd	5	3.14	3.02	34

Power supply	Colour	2700K	3000K	4000K
24Vdc		1E3472	1E3475	1E3478

LED / 5.5W / WFL



		3000K	H(m)	D(m)	E _{max} (lx)	
Ra84				44°		
Fixture Power	6W	1	0.80	583		
Source Flux	927lm	2	1.61	146		
Fixture Flux	355lm	3	2.41	65		
Efficacy	61lm/W	4	3.22	36		
TS1162	I _{max} =629cd/klm	I _{max}	583cd	5	4.02	23

Power supply	Colour	2700K	3000K	4000K
24Vdc		1E3473	1E3476	1E3479

JUPITER

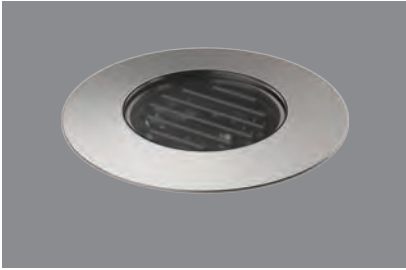

Driver-over with asymmetric screen

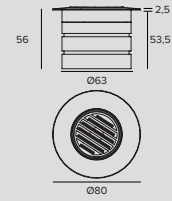

LED / 5.5W / SP										
	3000K	H(m)	D1(m)	D2(m)	E _{max} (lx)	Power supply	Colour	2700K	3000K	4000K
	Ra84		21°	22°		24Vdc	●	1E3489	1E3492	1E3495
	Fixture Power	6W	1	0.38	0.38	313				
	Source Flux	927lm	2	0.75	0.76	78				
	Fixture Flux	78lm	3	1.13	1.14	35				
	Efficacy	13lm/W	4	1.51	1.52	20				
TS1161	I _{max} =340cd/klm	I _{max}	315cd	5	1.88	1.91	13			

LED / 5.5W / FL										
	3000K	H(m)	D1(m)	D2(m)	E _{max} (lx)	Power supply	Colour	2700K	3000K	4000K
	Ra84		37°	44°		24Vdc	●	1E3490	1E3493	1E3496
	Fixture Power	6W	1	0.70	0.81	262				
	Source Flux	927lm	2	1.39	1.62	66				
	Fixture Flux	159lm	3	2.09	2.44	29				
	Efficacy	27lm/W	4	2.78	3.25	16				
TS1160	I _{max} =294cd/klm	I _{max}	272cd	5	3.48	4.06	10			

LED / 5.5W / ASY										
	3000K	H(m)	D1(m)	D2(m)	E _{max} (lx)	Power supply	Colour	2700K	3000K	4000K
	Ra84					24Vdc	●	1E3491	1E3494	1E3497
	Fixture Power	6W								
	Source Flux	946lm								
	Fixture Flux	72lm								
	Efficacy	12lm/W								
TS1153	I _{max} =107cd/klm	I _{max}	102cd							

Related codes

Power Supply					
10W - 220-240Vac, 24Vdc - 79x24,5x38mm - IP67	1E3179			1E0993	
50W - 220-240Vac, 24Vdc - 185x22x63,5mm - IP20	1T3726			Electronic power supply max 20W, Ø98 h78, 220/240V-AC, 24V-DC, IP68.	
75W - 220-240Vac, 24Vdc - 130x32x80mm - IP67	1T3586				
100W - 220-240Vac, 24Vdc - 230x87x43mm - IP67	1T3587				
200W - 220-240Vac, 24Vdc - 238x42x67mm - IP67	1T3588				
Electronic power supply LxHxP					

Accessories

Sleeve

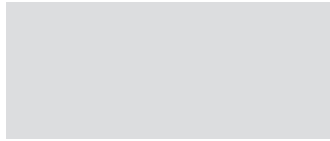

Ø	H	Code
75	80	1E3175

Installation sleeve.

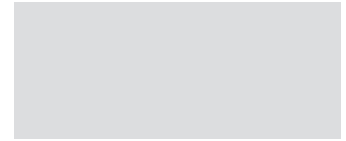

Ø	H	Code
75	80	1E3460

Installation sleeve.
For the drive-over version.

Connector

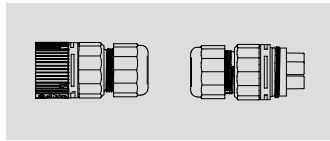
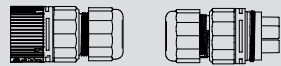

Code
1E2769

Connectors kit for 5 pole coaxial connections.
Remote mounting

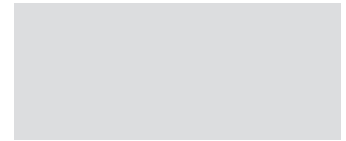

Code
1E2494

Non DALI looping connector.
1 IN - 3 OUT 4 poles max. wire section 2.5mm².
Cable diameter range from 8 to 12mm.
IP68

Control systems

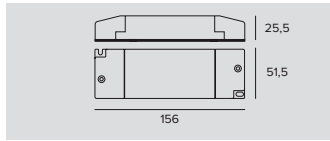
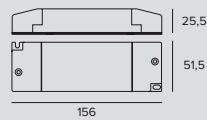

Code
1T6581

DALI/1-10V dimmer 12/24V.

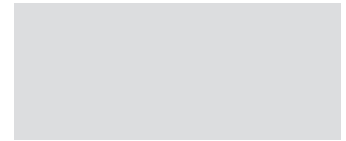

Code
1E3048

A IP67 Module for individual control of external devices equipped with DALI drivers.
The module needs to be positioned in order to receive radio signals.
The distance to the lighting fixtures can reach up to 50m.

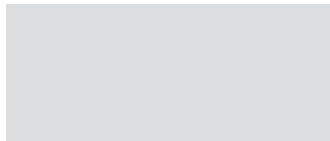

Code
1E3049

IP67 Extender for wireless control of DALI fixtures.
It generates a local DALI bus with the capacity to drive up to 64 fixtures.
Can control DALI fixtures in outdoor applications.

JUPITER



Mini Walk-over

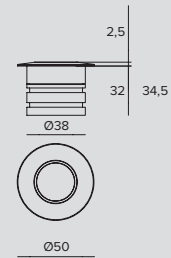

LED / 3W / SP



	3000K	H(m)	D(m)	E _{max} (lx)		
Ra84			17°			
Fixture Power	4W	1	0.31	2037		
Source Flux	353lm	2	0.61	509		
Fixture Flux	295lm	3	0.92	226		
Efficacy	74lm/W	4	1.23	127		
TS1048	I _{max} =5771cd/klm	I _{max}	2037cd	5	1.53	81

Power supply	Colour	3000K	4000K
24Vdc	●	1E3136	1E3137

LED / 3W / FL



	3000K	H(m)	D(m)	E _{max} (lx)		
Ra84			30°			
Fixture Power	4W	1	0.54	1062		
Source Flux	353lm	2	1.09	266		
Fixture Flux	289lm	3	1.63	118		
Efficacy	72lm/W	4	2.17	66		
TS1049	I _{max} =3009cd/klm	I _{max}	1062cd	5	2.72	42

Power supply	Colour	3000K	4000K
24Vdc	●	1E3138	1E3139

LED / 3W / WFL

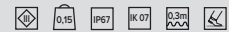

	3000K	H(m)	D(m)	E _{max} (lx)		
Ra84			60°			
Fixture Power	4W	1	1.16	367		
Source Flux	353lm	2	2.32	92		
Fixture Flux	302lm	3	3.47	41		
Efficacy	75lm/W	4	4.63	23		
TS1050	I _{max} =1041cd/klm	I _{max}	367cd	5	5.79	15

Power supply	Colour	3000K	4000K
24Vdc	●	1E3140	1E3141



Mini Driver-over

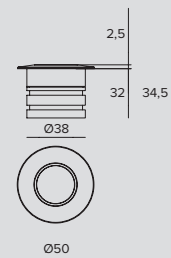

LED / 2.6W / SP



	3000K	H(m)	D(m)	E _{max} (lx)		
Ra84			19°			
Fixture Power	3W	1	0.34	740		
Source Flux	197lm	2	0.68	185		
Fixture Flux	126lm	3	1.02	82		
Efficacy	49lm/W	4	1.36	46		
TS1212	I _{max} =3750cd/klm	I _{max}	740cd	5	1.70	30

Power supply	Colour	2700K	3000K	4000K
24Vdc	●	1E3461	1E3464	1E3467

LED / 2.6W / FL



		3000K	H(m)	D(m)	E _{max} (lx)
Ra84				25°	
Fixture Power	3W	1	0.44	480	
Source Flux	197lm	2	0.88	120	
Fixture Flux	117lm	3	1.32	53	
Efficacy	45lm/W	4	1.75	30	
TS1213	I _{max} =2436cd/klm	I _{max}	480cd	5	2.19

Power supply	Colour	2700K	3000K	4000K
24Vdc	●	1E3462	1E3465	1E3468

LED / 2.6W / WFL



		3000K	H(m)	D(m)	E _{max} (lx)
Ra84				32°	
Fixture Power	3W	1	0.57	59	
Source Flux	197lm	2	1.14	15	
Fixture Flux	23lm	3	1.70	7	
Efficacy	9lm/W	4	2.27	4	
TS1214	I _{max} =298cd/klm	I _{max}	59cd	5	2.84

Power supply	Colour	2700K	3000K	4000K
24Vdc	●	1E3463	1E3466	1E3469

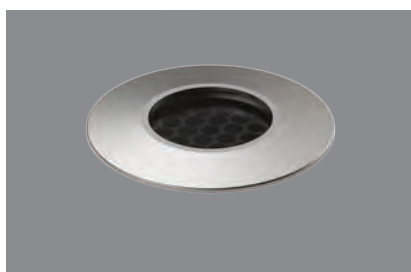

Mini Driver-over with grid

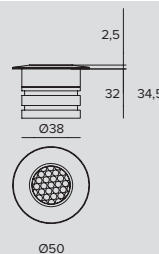

LED / 2.6W / SP



		3000K	H(m)	D(m)	E _{max} (lx)
Ra84				22°	
Fixture Power	3W	1	0.39	358	
Source Flux	197lm	2	0.78	90	
Fixture Flux	74lm	3	1.18	40	
Efficacy	28lm/W	4	1.57	22	
TS1215	I _{max} =1816cd/klm	I _{max}	358cd	5	1.96

Power supply	Colour	2700K	3000K	4000K
24Vdc	●	1E3480	1E3483	1E3486

LED / 2.6W / FL



		3000K	H(m)	D(m)	E _{max} (lx)
Ra84				23°	
Fixture Power	3W	1	0.40	468	
Source Flux	197lm	2	0.80	117	
Fixture Flux	93lm	3	1.19	52	
Efficacy	36lm/W	4	1.59	29	
TS1216	I _{max} =2371cd/klm	I _{max}	468cd	5	1.99

Power supply	Colour	2700K	3000K	4000K
24Vdc	●	1E3481	1E3484	1E3487

LED / 2.6W / WFL



		3000K	H(m)	D(m)	E _{max} (lx)
Ra84				28°	
Fixture Power	3W	1	0.49	285	
Source Flux	197lm	2	0.98	71	
Fixture Flux	81lm	3	1.47	32	
Efficacy	31lm/W	4	1.97	18	
TS1156	I _{max} =1442cd/klm	I _{max}	285cd	5	2.46

Power supply	Colour	2700K	3000K	4000K
24Vdc	●	1E3482	1E3485	1E3488

JUPITER



Mini Driver-over with asymmetric screen

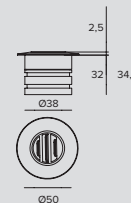

LED / 2.6W / SP

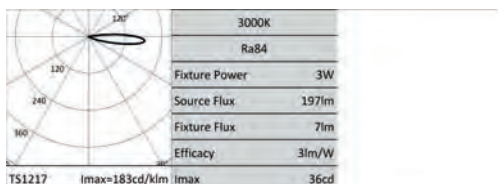

Power supply	Colour	2700K	3000K	4000K
24Vdc	●	1E3498	1E3501	1E3504

LED / 2.6W / FL

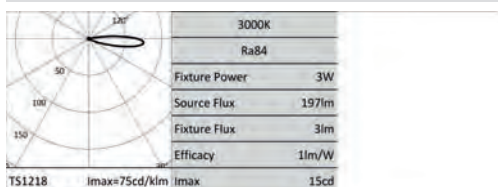

Power supply	Colour	2700K	3000K	4000K
24Vdc	●	1E3499	1E3502	1E3505

LED / 2.6W / WFL

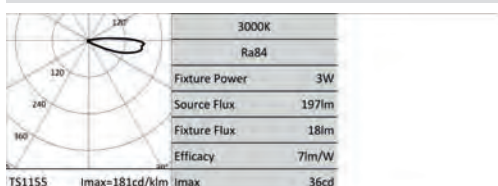

Power supply	Colour	2700K	3000K	4000K
24Vdc	●	1E3500	1E3503	1E3506

Related codes

Power Supply



	Code
10W - 220-240Vac, 24Vdc - 79x24,5x38mm - IP67	1E3179
50W - 220-240Vac, 24Vdc - 185x22x63,5mm - IP20	1T3726
75W - 220-240Vac, 24Vdc - 130x32x80mm - IP67	1T3586
100W - 220-240Vac, 24Vdc - 230x87x43mm - IP67	1T3587
200W - 220-240Vac, 24Vdc - 238x42x67mm - IP67	1T3588

Electronic power supply
LxHxP

	Code
Electronic power supply max 20W, Ø98 h78, 220/240V-AC, 24V-DC, IP68.	1E0993

Accessories

Sleeve

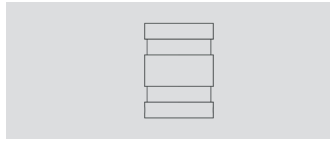

Ø	H	Code
40	60	1E3176

Installation sleeve.

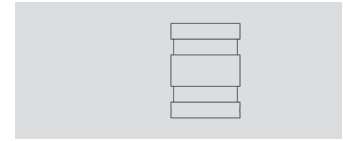

Ø	H	Code
44	60	1E3470

Installation sleeve.
For the drive-over version.

Connector

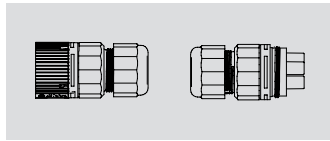

Code
1E2769

Connectors kit for 5 pole coaxial connections.
Remote mounting.

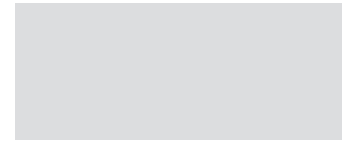

Code
1E2494

Non DALI looping connector.
1 IN - 3 OUT 4 poles max. wire section 2.5mm².
Cable diameter range from 8 to 12mm.
IP68

Control systems

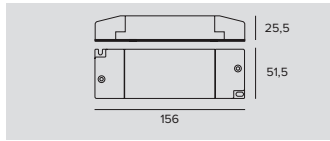

Code
1T6581

DALI/1-10V dimmer 12/24V.

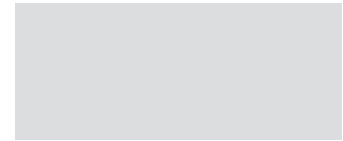

Code
1E3048

A IP67 Module for individual control of external devices equipped with DALI drivers.
The module needs to be positioned in order to receive radio signals.
The distance to the lighting fixtures can reach up to 50m.

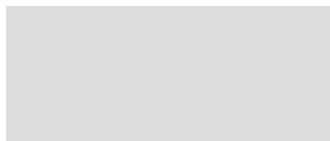

Code
1E3049

IP67 Extender for wireless control of DALI fixtures.
It generates a local DALI bus with the capacity to drive up to 64 fixtures.
Can control DALI fixtures in outdoor applications.

SATURN

GENERAL INFO

Miniaturised recessed fixture.
ø35mm – ø60mm

LED

LED Emitter
From 353lm to 682lm
3000K – 4000K
Ra84

PRODUCT EFFICACY

Up to 10lm/W

OPTICS

WFL

POWER SUPPLY

Electronic – DALI – 1-10V
Casambi control: the DALI version is fitted with special accessories.

MATERIAL

Anodised polished aluminium body. Front made entirely of screen-printed, opal white glass.

A range of miniature 24V inground fixtures with a glass finishing ring for an elegant glass only effect. It is available in two different sizes, both extremely compact and flush opal glass that screens the lamp to produce a soft light.

The 24V voltage, the absence of visible screws and the “glass only” effect make it particularly suitable for indoor installations in hospitality, SPAs or homes. The glass only finish for Saturn goes perfectly with the same aesthetic solution in the Mercure range, to light environments in different ways using the same family feeling.

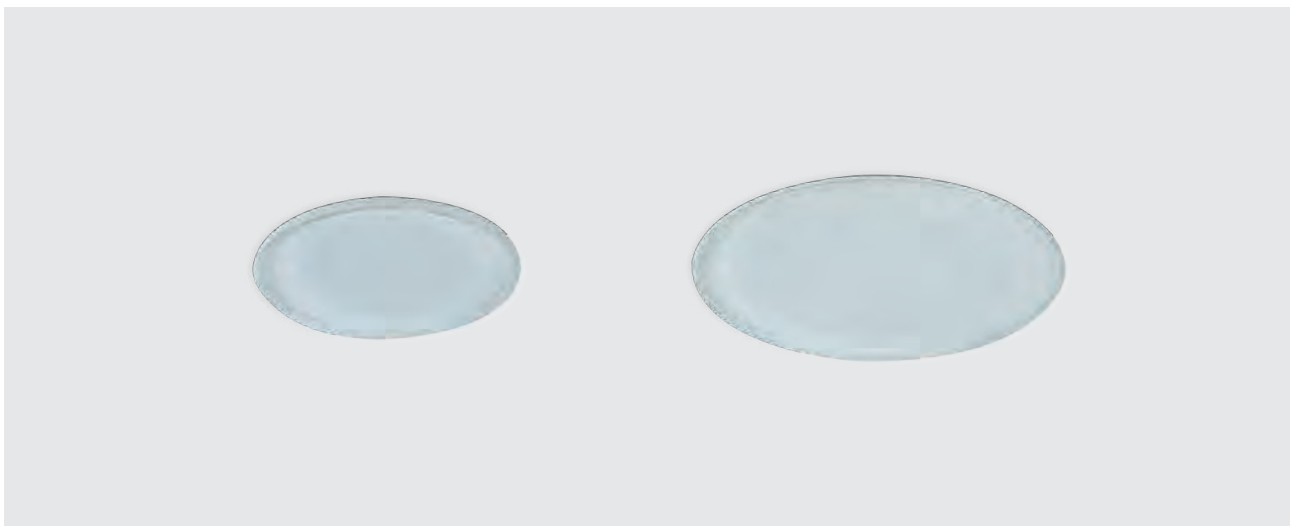



Park Hyatt

Photographer
Gregor Titze

Country
Wien - Austria

SATURN



LED / 4W / WFL								
	3000K	H(m)	D(m)	Emax(lx)	Power supply	3000K	4000K	
	Ra84		115°			24Vdc	1E3144	1E3145
	Fixture Power	5W	1	3.13		16		
	Source Flux	638lm	2	6.27		4		
	Fixture Flux	48lm	3	9.40		2		
	Efficacy	10lm/W	4	12.53		1		
TS1051	Imax=26cd/klm	Imax	16cd	5	15.67	1		

Related codes

Power Supply			
	Code		Code
10W - 220-240Vac, 24Vdc - 79x24,5x38mm - IP67	1E3179		1E0993
50W - 220-240Vac, 24Vdc - 185x22x63,5mm - IP20	1T3726		
75W - 220-240Vac, 24Vdc - 130x32x80mm - IP67	1T3586		
100W - 220-240Vac, 24Vdc - 230x87x43mm - IP67	1T3587		
200W - 220-240Vac, 24Vdc - 238x42x67mm - IP67	1T3588		
Electronic power supply LxHxP		Electronic power supply max 20W, Ø98 h78, 220/240V-AC, 24V-DC, IP68.	

Accessories

Sleeve



Code

1E3177

Installation sleeve.
Flush installation h 70, Ø 65mm.
Straight installation h 60, Ø 57mm.

Connector

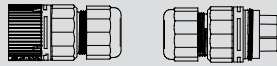

Code

1E2769

Connectors kit for 5 pole coaxial connections.
Remote mounting



Code

1E2494

Non DALI looping connector.
1 IN - 3 OUT 4 poles max. wire section 2.5mm².
Cable diameter range from 8 to 12mm.
IP68

Control systems

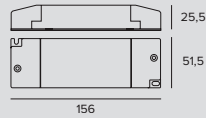

Code

1T6581

DALI/1-10V dimmer 12/24V.



Code

1E3048

A IP67 Module for individual control of external devices equipped with DALI drivers.
The module needs to be positioned in order to receive radio signals.
The distance to the lighting fixtures can reach up to 50m.



Code

1E3049

IP67 Extender for wireless control of DALI fixtures.
It generates a local DALI bus with the capacity to drive up to 64 fixtures.
Can control DALI fixtures in outdoor applications.

SATURN

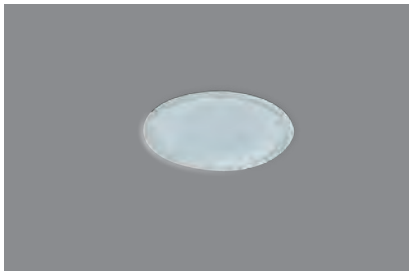

Mini



LED / 2,6W / WFL							
	3000K	H(m)	D(m)	Emax(lx)	Power supply	3000K	4000K
	Ra84		122'		24Vdc	1E3146	1E3147
	Fixture Power	3W	1	3.59			
	Source Flux	353lm	2	7.18			
	Fixture Flux	11lm	3	10.77			
	Efficacy	4lm/W	4	14.36			
TS1052	Imax=10cd/klm	Imax	4cd	5	17.95		

Related codes

Power Supply	
<p>Code 1E3179</p> <p>Electronic power supply 10W, LxHxP=79x24.5x38mm, 220/240V-AC, 24V-DC, IP67.</p>	<p>Code 1E0993</p> <p>Electronic power supply max 20W, Ø98 h78, 220/240V-AC, 24V-DC, IP68. For Led.Y Multiled: up to 16 LED.Y connected in parallel.</p>
<p>Code 1T3726</p> <p>Electronic power supply 50W, LxHxP=185x22x63.5mm, 220-240V, 24V-DC, IP20.</p>	<p>Code 1T3586</p> <p>Electronic power supply 75W, LxHxP=130x32x80mm, 220-240V, 24V-DC, IP67.</p>
<p>Code 1T3587</p> <p>Electronic power supply 100W, LxHxP=230x87x43mm, 220-240V, 24V-DC, IP67.</p>	<p>Code 1T3588</p> <p>Electronic power supply 200W, LxHxP=238x42x67mm, 220-240V, 24V-DC, IP67.</p>

Accessories

Sleeve

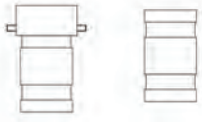

Code

1E3178

Installation sleeve.
Flush installation h 70, Ø 40mm.
Straight installation h 60, Ø 34mm.

Connector

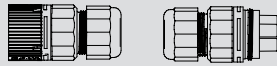

Code

1E2769

Connectors kit for 5 pole coaxial connections.
Remote mounting.



Code

1E2494

Non DALI looping connector.
1 IN - 3 OUT 4 poles max. wire section 2.5mm².
Cable diameter range from 8 to 12mm.
IP68

Control systems

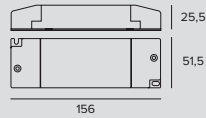

Code

1T6581

DALI/1-10V dimmer 12/24V.



Code

1E3048

A IP67 Module for individual control of external devices equipped with DALI drivers.
The module needs to be positioned in order to receive radio signals.
The distance to the lighting fixtures can reach up to 50m.



Code

1E3049

IP67 Extender for wireless control of DALI fixtures.
It generates a local DALI bus with the capacity to drive up to 64 fixtures.
Can control DALI fixtures in outdoor applications.

LED.Y

GENERAL INFO

Recessed fixture
Multiled
ø60mm – ø68mm
Monoled-RGB
ø63mm

LED

Monoled: LED emitter
3000K – 6000K
From 99lm to 143lm
Ra80
Multiled: LED Board
6000K – Blue – Amber
From 1lm to 7lm
Ra80
RGB: RGB LED Multichip
From 40lm to 48lm

PRODUCT EFFICACY

Up to 99lm/W

OPTICS

Monoled
SP - FL
Multiled/RGB
VWFL

POWER SUPPLY

Electronic

MATERIAL

Anodised aluminium body and ring.

A series of miniature LED fixtures available in recessed or projector versions with monochromatic LED and RGB technology. The monochromatic versions are both mono and multi-LED.

The recessed version has a flat, flared edge and domed glass for a choreographic effect.



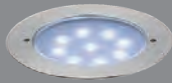

Multiled flush ring - flat screen

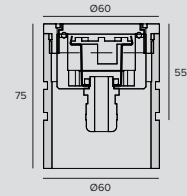

LED / 1W / VWFL



		6000K	H(m)	D(m)	E _{max} (lx)
				102*	
Fixture Power	2W	1	2.47	2	
Source Flux	5lm	2	4.94	0	
Fixture Flux	5lm	3	7.41	0	
Efficacy	3lm/W	4	9.87	0	
EV070	I _{max} =395cd/klm	I _{max}	2cd	5	12.34

Power supply	Colour	6000K	AMBER	BLUE
24Vdc	●	1E1022	1E1021	1E1028

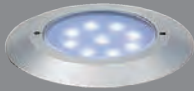

Multiled raised ring - flat screen

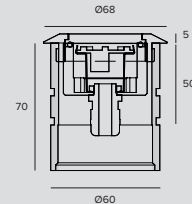

LED / 1W / VWFL

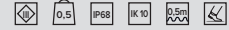

		6000K	H(m)	D(m)	E _{max} (lx)
				102*	
Fixture Power	2W	1	2.47	2	
Source Flux	5lm	2	4.94	0	
Fixture Flux	5lm	3	7.41	0	
Efficacy	3lm/W	4	9.87	0	
EV070	I _{max} =395cd/klm	I _{max}	2cd	5	12.34

Power supply	Colour	6000K	AMBER	BLUE
24Vdc	●	1E1012	1E1011	1E1018

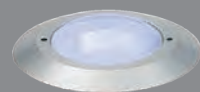

Multiled raised ring curved screen

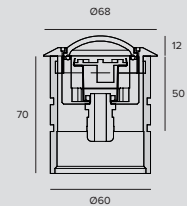

LED / 1W / VWFL

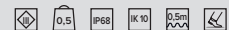

		6000K	H(m)	D(m)	E _{max} (lx)
				102*	
Fixture Power	2W	1	2.47	2	
Source Flux	5lm	2	4.94	0	
Fixture Flux	5lm	3	7.41	0	
Efficacy	3lm/W	4	9.87	0	
EV070	I _{max} =395cd/klm	I _{max}	2cd	5	12.34

Power supply	Colour	6000K	AMBER	BLUE
24Vdc	●	1E1002	1E1001	1E1008

Note

All LED.Y fixtures meet all the requirements of EN 60598-2-13 standard regarding pedestrian use and are therefore ideal for lighting all the areas provided for by the regulations, such as pedestrian zones and other designated areas.

LED.Y

Related codes

Power Supply



Code

1E0993

Electronic power supply max 20W, Ø98 h78, 220/240V-AC, 24V-DC, IP68.
For Led.Y Multiled: up to 16 LED.Y connected in parallel.

Accessories

Mounting System

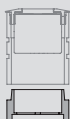

Code

1E0994

Installation kit.
Extension for the PVC casing.
A wider space facilitates electrical connections.
Water tight electrical connection system is not included.

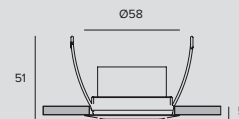

Code

1E0996

Steel spring. For ceiling and wall installation.

Tool



Code

1E0990

Mounting key.

Connector



Code

1E2769

Connectors kit for 5 pole coaxial connections.
Remote mounting.



Code

1E2494

Non DALI looping connector.
1 IN - 3 OUT 4 poles max. wire section 2.5mm².
Cable diameter range from 8 to 12mm.
IP68

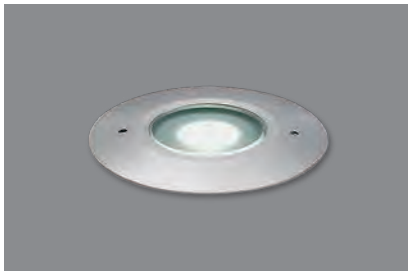

Monoled

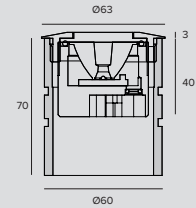

LED / 2W / SP

	3000K	H(m)	D(m)	E _{max} (lx)		
Ra80			9°			
Fixture Power	3W	1	0.16	2012		
Source Flux	117lm	2	0.32	503		
Fixture Flux	116lm	3	0.48	224		
Efficacy	39lm/W	4	0.64	126		
T5670	I _{max} =17195cd/klm	I _{max}	2012cd	5	0.80	80

Power supply	Colour	3000K	6000K
700mA		1E2367	1E2368

LED / 2W / FL

	3000K	H(m)	D(m)	E _{max} (lx)		
Ra80			34°			
Fixture Power	3W	1	0.60	223		
Source Flux	99lm	2	1.21	56		
Fixture Flux	99lm	3	1.81	25		
Efficacy	33lm/W	4	2.42	14		
T5671	I _{max} =2253cd/klm	I _{max}	223cd	5	3.02	9

Power supply	Colour	3000K	6000K
700mA		1E2369	1E2370

Note

All LED.Y fixtures meet all the requirements of EN 60598-2-13 standard regarding pedestrian use and are therefore ideal for lighting all the areas provided for by the regulations, such as pedestrian zones and other designated areas.

Related codes

Power Supply

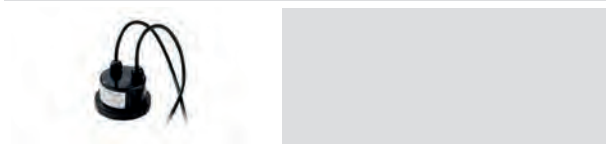

Code

1E1385

Electronic power supply 17W, Ø105 h74, 220-240V, 700mA - 12W, Ø105 h74, 110-120V, 700mA.

For Led.Y Monoled: it can drive up to 6 LED.Y fixtures simultaneously. Connection in series.

LED.Y

Accessories

Mounting System

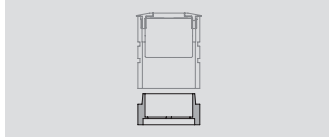

Code

1E0994

Installation kit.
Extension for the PVC casing.
A wider space facilitates electrical connections.
Water tight electrical connection system is not included.

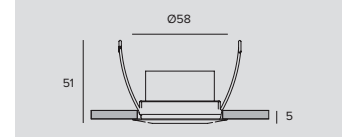

Code

1E0996

Steel spring. For ceiling and wall installation.

Tool

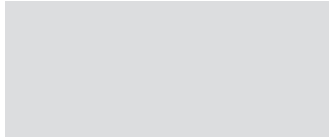

Code

1E0990

Mounting key.

Connector

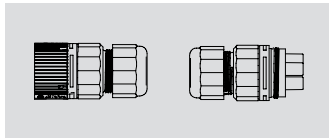

Code

1E2769

Connectors kit for 5 pole coaxial connections.
Remote mounting.

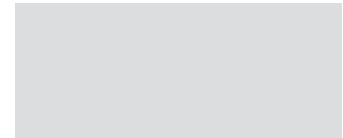

Code

1E2494

Non DALI looping connector.
1 IN - 3 OUT 4 poles max. wire section 2.5mm².
Cable diameter range from 8 to 12mm.
IP68



Monoled RGB

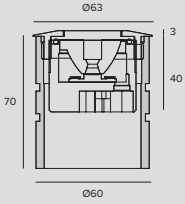

LED RGB / 3,5W / SP



Power supply	Colour	RGB
3x350mA		1E1854



LED RGB / 3,5W / FL

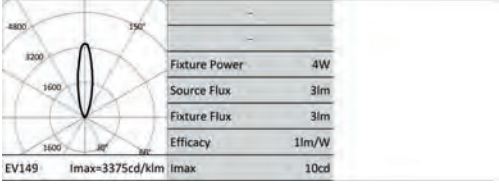

Power supply	Colour	RGB
3x350mA		1E1409

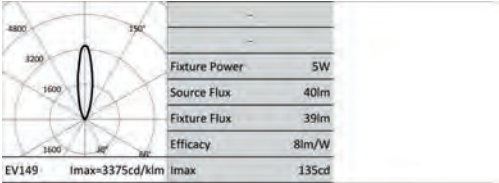

Note

Photometrics show the maximum emission values of fixtures.

All LED.Y fixtures meet all the requirements of EN 60598-2-13 standard regarding pedestrian use and are therefore ideal for lighting all the areas provided for by the regulations, such as pedestrian zones and other designated areas.

LED.Y

Related codes

Control systems



Code

1E1401

SECS 75 - IP67

Power supply and Control System SECS Scene Effect Control System.

SECS 75 drivers combine the following 3 functions in a single unit.; power supply to RGB LED devices, playback of pre-set colour sequences and a DMX interface for external control devices.

The SECS "Easy-Run-Menu" function is able to playback colour-changing light scenarios that are pre-stored into the driver without the use of an external driver: - 8 static colour scenarios; - 8 dynamic colour sequences; - 5 different playback speed values; - Start/Stop the selected scenario using a remote switch.

SECS 75 drivers can also be controlled through DMX 512; in this case: - DMX address (from 1 to 511) can be configured by using dip-switches; - 3 channel mode: all R-G-B outputs are controlled simultaneously by 3 DMX channels only; - 6 channel mode: the outputs are divided into 2 R-G-B groups, each one controlled by 3 different DMX channels; - DMX line termination: SECS drivers contain a 120Ohm resistance which can be activated using a dip-switch; - DMX output is available for connection to other DMX devices.

75W output



Code

1T1827

SECS 75 - IP20

Power supply and Control System SECS Scene Effect Control System.

SECS 75 drivers combine the following 3 functions in a single unit.; power supply to RGB LED devices, playback of pre-set colour sequences and a DMX interface for external control devices.

The SECS "Easy-Run-Menu" function is able to playback colour-changing light scenarios that are pre-stored into the driver without the use of an external driver: - 8 static colour scenarios; - 8 dynamic colour sequences; - 5 different playback speed values; - Start/Stop the selected scenario using a remote switch.

SECS 75 drivers can also be controlled through DMX 512; in this case: - DMX address (from 1 to 511) can be configured by using dip-switches; - 3 channel mode: all R-G-B outputs are controlled simultaneously by 3 DMX channels only; - 6 channel mode: the outputs are divided into 2 R-G-B groups, each one controlled by 3 different DMX channels; - DMX line termination: SECS drivers contain a 120Ohm resistance which can be activated using a dip-switch; - DMX output is available for connection to other DMX devices.

75W output



Code

1T2245

SECS 36 - IP20

Power supply and Control System SECS Scene Effect Control System.

SECS 36 drivers combine the following 3 functions in a single unit.; power supply to RGB LED devices, playback of pre-set colour sequences and a DMX interface for external control devices.

The SECS "Easy-Run-Menu" function is able to playback colour-changing light scenarios that are pre-stored into the driver without the use of an external driver: - 8 static colour scenarios; - 8 dynamic colour sequences; - 5 different playback speed values; - Start/Stop the selected scenario using a remote switch.

SECS 75 drivers can also be controlled through DMX 512; in this case: - DMX address (from 1 to 511) can be configured by using dip-switches; - 3 channel mode: all R-G-B outputs are controlled simultaneously by 3 DMX channels only; - 6 channel mode: the outputs are divided into 2 R-G-B groups, each one controlled by 3 different DMX channels; - DMX line termination: SECS drivers contain a 120Ohm resistance which can be activated using a dip-switch; - DMX output is available for connection to other DMX devices.

35W output

Accessories

Mounting System



Code

1E0994

Installation kit.

Extension for the PVC casing.

A wider space facilitates electrical connections.

Water tight electrical connection system is not included.

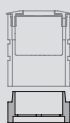

Code

1E0996

Steel spring. For ceiling and wall installation.

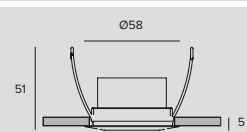

Tool



Code

1E0990

Mounting key.

Cable

Code

1E1713

6-pole cable for driver output connection to Constant Current LED sources.

Control systems



Code

1T1898

my-SCENARIO Show Store.

Digital devices designed to control dynamic lighting fixtures and programme dynamic light scenarios and sequences.

The system consists of intuitive software, compatible with Windows operating systems, able to control different hardware devices with the following functions: - record colour-changing scenarios set by the operator; - allow selection among the multiple scenarios already recorded; - transmit the control signals to the lighting system.

The software is interfaced to the PC through a USB port; the interface with lighting fixtures is featured through a DMX 512 output.

The software provides a graphic simulation of the operating keys of a lighting controller; the patching function allows the DMX control channels to be assigned to fixtures by using the internal library.

The Colour Manager function allows for quick and intuitive programming of a RGB light show, consisting of several steps with assigned duration and fading times.

The built-in calendar allows full time scheduling of show playback (month, day, hour, minutes, recurring events).

The programmed light shows can be transferred to different control interfaces.

Outdoor

Projectors

Linear projectors



630
JEDI



642
JEDI COMPACT

Projectors



656
DART



662
DART MEDIUM



669
DART MINI



674
PYROS



682
NANO PYROS



687
PICO PYROS



688
JUPITER PRO



699
JUPITER



702
LED.Y



JEDI

Projector

GENERAL INFO

Adjustable linear projector.
Lengths 616mm – 916mm – 1216mm

LED

Optics FL, GR, WW - Linear boards
Optic SP - LED Emitter
Version RGBW - LED Emitter
From 632lm to 7180m
3000K – 4000K – RGBW
Ra80

PRODUCT EFFICACY

Unitil 113lm/W

OTTICHE

SP – FL – GRAZING – WALL WASHER

POWER SUPPLY

Electronic – DALI

MATERIAL

Extruded anodised aluminium body.
Extra clear glass flat screen.
Black polycarbonate driver box.

A coordinated range of linear projectors for lighting large surfaces.

A coordinated range of linear projectors for lighting wide surfaces. The multiplicity of effects, installation flexibility, three different lengths and the possibility to camouflage them into the architecture make them fundamental tools for lighting large surfaces.

The accessory fixing system allows the projector to be adjusted with aim locking.

Completely sealed housing complete - external electrical connection through IP68 connectors.

Also available Inground and RGB versions.



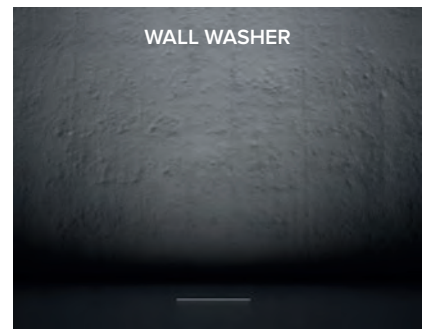
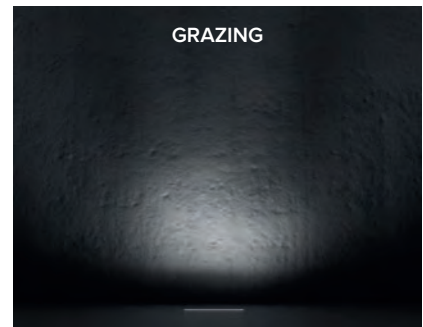

Four different effects

Spot and Flood optics to obtain more concentrated, precise lighting.
 Grazing Optic for a grazing, uniform light effect for installation near to the wall to be illuminated. Wall Washer Optic for a completely homogeneous effect on the wall, thus avoiding any bright stripes or separate beams that are typical of linear fixtures that are fitted with visible LED strips.

The different lengths have proportioned lumen packets to suit each one

The different lengths have proportioned lumen packets to suit each one. The same quantity of light per linear metre makes it possible to light every surface in a uniform way irrespective of the length of the fixture used.



Projector L. 616mm

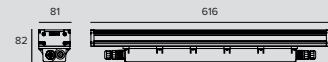

LED / 23W / SPOT									
	3000K	H(m)	D(m)	E _{max} (lx)	Driver	Colour	3000K	4000K	
	Ra80		10°		EL.	●	1E2653	1E2654	
	Fixture Power	28W	1	0.18	32201	DALI	●	1E2655	1E2656
	Source Flux	1947lm	2	0.37	8050				
	Fixture Flux	1591lm	3	0.55	3578				
	Efficacy	57lm/W	4	0.73	2013				
TS889	I _{max} =16539cd/klm	I _{max}	32201cd	5	0.92	1288			

LED / 12W / FLOOD										
	3000K	H(m)	D1(m)	D2(m)	E _{max} (lx)	Driver	Colour	3000K	4000K	
	Ra80		85°	32°		EL.	●	1E2605	1E2606	
	Fixture Power	15W	1	1.84	0.57	1203	DALI	●	1E2607	1E2608
	Source Flux	1720lm	2	3.68	1.14	301				
	Fixture Flux	1285lm	3	5.53	1.70	134				
	Efficacy	86lm/W	4	7.37	2.27	75				
TS886	I _{max} =699cd/klm	I _{max}	1203cd	5	9.21	2.84	48			

LED / 24W / FLOOD										
	3000K	H(m)	D1(m)	D2(m)	E _{max} (lx)	Driver	Colour	3000K	4000K	
	Ra80		85°	32°		EL.	●	1E2609	1E2610	
	Fixture Power	28W	1	1.84	0.57	2392	DALI	●	1E2611	1E2612
	Source Flux	3420lm	2	3.68	1.14	598				
	Fixture Flux	2555lm	3	5.53	1.70	266				
	Efficacy	91lm/W	4	7.37	2.27	149				
TS885	I _{max} =699cd/klm	I _{max}	2392cd	5	9.21	2.84	96			

LED / 12W / WALL WASHER										
	3000K	H(m)	D1(m)	D2(m)	E _{max} (lx)	Driver	Colour	3000K	4000K	
	Ra80		115°	59°		EL.	●	1E2629	1E2630	
	Fixture Power	15W	1	3.12	1.34	1156	DALI	●	1E2631	1E2632
	Source Flux	1720lm	2	6.23	2.67	289				
	Fixture Flux	1293lm	3	9.35	4.01	128				
	Efficacy	86lm/W	4	12.47	5.35	72				
TS884	I _{max} =774cd/klm	I _{max}	1331cd	5	15.58	6.69	46			

LED / 24W / WALL WASHER										
	3000K	H(m)	D1(m)	D2(m)	E _{max} (lx)	Driver	Colour	3000K	4000K	
	Ra80		115°	59°		EL.	●	1E2633	1E2634	
	Fixture Power	28W	1	3.12	1.34	2299	DALI	●	1E2635	1E2636
	Source Flux	3420lm	2	6.23	2.67	575				
	Fixture Flux	2572lm	3	9.35	4.01	255				
	Efficacy	92lm/W	4	12.47	5.35	144				
TS883	I _{max} =774cd/klm	I _{max}	2646cd	5	15.59	6.69	92			

LED / 12W / GRAZING



		3000K	H(m)	D1(m)	D2(m)	E _{max} (lx)
Ra80			76°	15°		
Fixture Power	15W	1	1.55	0.26	2753	
Source Flux	1720lm	2	3.10	0.51	688	
Fixture Flux	1429lm	3	4.65	0.77	306	
Efficacy	95lm/W	4	6.20	1.02	172	
TS888	I _{max} =1601cd/klm	I _{max}	2753cd	5	7.76	1.28 110

Driver	Colour	3000K	4000K
EL.	●	1E2581	1E2582
DALI	●	1E2583	1E2584

LED / 24W / GRAZING



		3000K	H(m)	D1(m)	D2(m)	E _{max} (lx)
Ra80			76°	15°		
Fixture Power	28W	1	1.55	0.26	5474	
Source Flux	3420lm	2	3.10	0.51	1368	
Fixture Flux	2842lm	3	4.65	0.77	608	
Efficacy	101lm/W	4	6.21	1.02	342	
TS887	I _{max} =1601cd/klm	I _{max}	5474cd	5	7.76	1.28 219

Driver	Colour	3000K	4000K
EL.	●	1E2585	1E2586
DALI	●	1E2587	1E2588



Projector L. 916mm



LED / 34W / SPOT



		3000K	H(m)	D(m)	E _{max} (lx)	
Ra80				10°		
Fixture Power	40W	1	0.18	48326		
Source Flux	2922lm	2	0.37	12081		
Fixture Flux	2387lm	3	0.55	5370		
Efficacy	60lm/W	4	0.73	3020		
TS889	I _{max} =16539cd/klm	I _{max}	48326cd	5	0.92	1933

Driver	Colour	3000K	4000K
EL.	●	1E2657	1E2658
DALI	●	1E2659	1E2660

LED / 18W / FLOOD



		3000K	H(m)	D1(m)	D2(m)	E _{max} (lx)
Ra80			85°	32°		
Fixture Power	22W	1	1.84	0.57	1804	
Source Flux	2580lm	2	3.68	1.14	451	
Fixture Flux	1927lm	3	5.53	1.70	200	
Efficacy	88lm/W	4	7.37	2.27	113	
TS886	I _{max} =699cd/klm	I _{max}	1804cd	5	9.21	2.84 72

Driver	Colour	3000K	4000K
EL.	●	1E2613	1E2614
DALI	●	1E2615	1E2616

LED / 36W / FLOOD



		3000K	H(m)	D1(m)	D2(m)	E _{max} (lx)
Ra80			85°	32°		
Fixture Power	40W	1	1.84	0.57	3588	
Source Flux	5130lm	2	3.68	1.14	897	
Fixture Flux	3833lm	3	5.53	1.70	399	
Efficacy	96lm/W	4	7.37	2.27	224	
TS885	I _{max} =699cd/klm	I _{max}	3588cd	5	9.21	2.84 144

Driver	Colour	3000K	4000K
EL.	●	1E2617	1E2618
DALI	●	1E2619	1E2620

LED / 18W / WALL WASHER



		3000K	H(m)	D1(m)	D2(m)	E _{max} (lx)	
Ra80				115°	59°		
Fixture Power	22W	1	3.12	1.34	1735		
Source Flux	2580lm	2	6.23	2.67	434		
Fixture Flux	1940lm	3	9.35	4.01	193		
Efficacy	88lm/W	4	12.47	5.35	108		
TS884	I _{max} =774cd/klm	I _{max}	1996cd	5	15.58	6.69	69

Driver	Colour	3000K	4000K
EL.	●	1E2637	1E2638
DALI	●	1E2639	1E2640

LED / 36W / WALL WASHER



		3000K	H(m)	D1(m)	D2(m)	E _{max} (lx)	
Ra80				115°	59°		
Fixture Power	40W	1	3.12	1.34	3449		
Source Flux	5130lm	2	6.23	2.67	862		
Fixture Flux	3858lm	3	9.35	4.01	383		
Efficacy	96lm/W	4	12.47	5.35	216		
TS883	I _{max} =774cd/klm	I _{max}	3969cd	5	15.59	6.69	138

Driver	Colour	3000K	4000K
EL.	●	1E2641	1E2642
DALI	●	1E2643	1E2644

LED / 18W / GRAZING



		3000K	H(m)	D1(m)	D2(m)	E _{max} (lx)	
Ra80				76°	15°		
Fixture Power	22W	1	1.55	0.26	4130		
Source Flux	2580lm	2	3.10	0.51	1032		
Fixture Flux	2144lm	3	4.65	0.77	459		
Efficacy	97lm/W	4	6.20	1.02	258		
TS888	I _{max} =1601cd/klm	I _{max}	4130cd	5	7.76	1.28	165

Driver	Colour	3000K	4000K
EL.	●	1E2589	1E2590
DALI	●	1E2591	1E2592

LED / 36W / GRAZING



		3000K	H(m)	D1(m)	D2(m)	E _{max} (lx)	
Ra80				76°	15°		
Fixture Power	40W	1	1.55	0.26	8211		
Source Flux	5130lm	2	3.10	0.51	2053		
Fixture Flux	4263lm	3	4.65	0.77	912		
Efficacy	107lm/W	4	6.21	1.02	513		
TS887	I _{max} =1601cd/klm	I _{max}	8211cd	5	7.76	1.28	328

Driver	Colour	3000K	4000K
EL.	●	1E2593	1E2594
DALI	●	1E2595	1E2596



Projector L. 1216mm

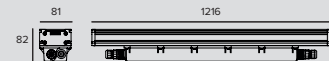

LED / 46W / SPOT



		3000K	H(m)	D(m)	E _{max} (lx)	
Ra80				10°		
Fixture Power	51W	1	0.18	64401		
Source Flux	3894lm	2	0.37	16100		
Fixture Flux	3181lm	3	0.55	7156		
Efficacy	62lm/W	4	0.73	4025		
TS889	I _{max} =16539cd/klm	I _{max}	64401cd	5	0.92	2576

Driver	Colour	3000K	4000K
EL.	●	1E2661	1E2662
DALI	●	1E2663	1E2664

LED / 24W / FLOOD



		3000K	H(m)	D1(m)	D2(m)	Emax(lx)	
Ra80				85°	32°		
Fixture Power	28W	1	1.84	0.57	2405		
Source Flux	3440lm	2	3.68	1.14	601		
Fixture Flux	2570lm	3	5.53	1.70	267		
Efficacy	92lm/W	4	7.37	2.27	150		
TS886	Imax=699cd/klm	Imax	2405cd	5	9.21	2.84	96

Driver	Colour	3000K	4000K
EL.	●	1E2621	1E2622
DALI	●	1E2623	1E2624

LED / 48W / FLOOD



		3000K	H(m)	D1(m)	D2(m)	Emax(lx)	
Ra80				85°	32°		
Fixture Power	53W	1	1.84	0.57	4784		
Source Flux	6840lm	2	3.68	1.14	1196		
Fixture Flux	5111lm	3	5.53	1.70	532		
Efficacy	96lm/W	4	7.37	2.27	299		
TS885	Imax=699cd/klm	Imax	4784cd	5	9.21	2.84	191

Driver	Colour	3000K	4000K
EL.	●	1E2625	1E2626
DALI	●	1E2627	1E2628

LED / 24W / WALL WASHER



		3000K	H(m)	D1(m)	D2(m)	Emax(lx)	
Ra80				115°	59°		
Fixture Power	28W	1	3.12	1.34	2313		
Source Flux	3440lm	2	6.23	2.67	578		
Fixture Flux	2587lm	3	9.35	4.01	257		
Efficacy	92lm/W	4	12.47	5.35	145		
TS884	Imax=774cd/klm	Imax	2662cd	5	15.58	6.69	93

Driver	Colour	3000K	4000K
EL.	●	1E2645	1E2646
DALI	●	1E2647	1E2648

LED / 48W / WALL WASHER



		3000K	H(m)	D1(m)	D2(m)	Emax(lx)	
Ra80				115°	59°		
Fixture Power	53W	1	3.12	1.34	4599		
Source Flux	6840lm	2	6.23	2.67	1150		
Fixture Flux	5144lm	3	9.35	4.01	511		
Efficacy	97lm/W	4	12.47	5.35	287		
TS883	Imax=774cd/klm	Imax	5293cd	5	15.59	6.69	184

Driver	Colour	3000K	4000K
EL.	●	1E2649	1E2650
DALI	●	1E2651	1E2652

LED / 24W / GRAZING



		3000K	H(m)	D1(m)	D2(m)	Emax(lx)	
Ra80				76°	15°		
Fixture Power	28W	1	1.55	0.26	5506		
Source Flux	3440lm	2	3.10	0.51	1377		
Fixture Flux	2859lm	3	4.65	0.77	612		
Efficacy	102lm/W	4	6.20	1.02	344		
TS888	Imax=1601cd/klm	Imax	5506cd	5	7.76	1.28	220

Driver	Colour	3000K	4000K
EL.	●	1E2597	1E2598
DALI	●	1E2599	1E2600

LED / 48W / GRAZING



		3000K	H(m)	D1(m)	D2(m)	Emax(lx)	
Ra80				76°	15°		
Fixture Power	53W	1	1.55	0.26	10948		
Source Flux	6840lm	2	3.10	0.51	2737		
Fixture Flux	5684lm	3	4.65	0.77	1216		
Efficacy	107lm/W	4	6.21	1.02	684		
TS887	Imax=1601cd/klm	Imax	10948cd	5	7.76	1.28	438

Driver	Colour	3000K	4000K
EL.	●	1E2601	1E2602
DALI	●	1E2603	1E2604

JEDI

Related codes

Mounting System

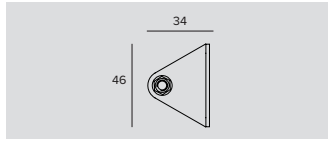

Code

1E2752

Short bracket for wall installation (2 pieces).

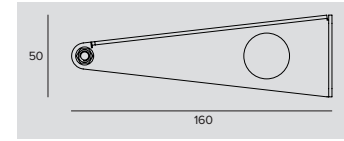

Code

1E2753

Long bracket for wall installation (2 pieces).

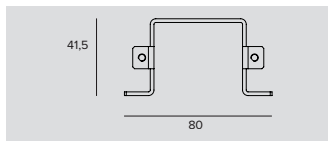

Code

1E2754

Bracket for ceiling installation (2 pieces).

Accessories

End Caps



Code

1E2761

End cap.

Cable

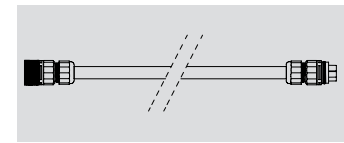

L

Code

320 **1E2762**

470 **1E2763**

620 **1E2764**

770 **1E2765**

Connection cable.

Complete with 5 pole connectors.

For the electronic and DALI version.

1E2762

For in line adjacent connection of one 600mm projector with one 900mm projector.

1E2763

For in line adjacent connection of one 600mm projector with one 1200mm projector or two 900mm projectors.

1E2764

For in line adjacent connection of one 900mm projector with one 1200mm projector.

1E2765

For in line adjacent connection of two 1200mm projectors.

Connector

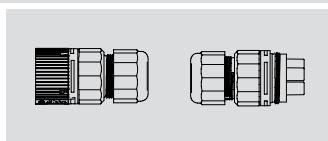

Code

1E2769

Connectors kit for 5 pole coaxial connections.

Cover Panel

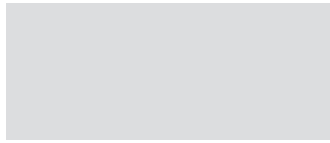

L	Code
616	1E3045
916	1E3046
1216	1E3047

Side cover for ceiling installation.

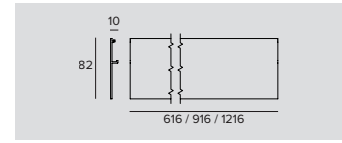

L	Code
616	1E2755
916	1E2756
1216	1E2757

Side cover for wall/cornice installation.

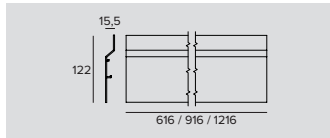

L	Code
616	1E2758
916	1E2759
1216	1E2760

Anti-glare side cover.

Control systems

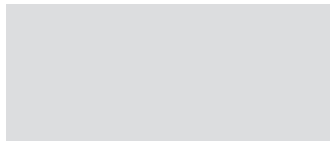

Code
1E3048

A IP67 Module for individual control of external devices equipped with DALI drivers. The module needs to be positioned in order to receive radio signals. The distance to the lighting fixtures can reach up to 50m.

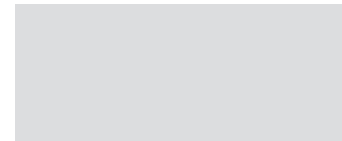

Code
1E3049

IP67 Extender for wireless control of DALI fixtures. It generates a local DALI bus with the capacity to drive up to 64 fixtures. Can control DALI fixtures in outdoor applications.



Projector RGBW L. 616mm

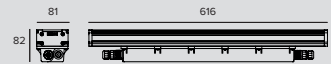

LED RGBW / 17W 4Ch / SPOT



		H(m)	D(m)	E _{max} (lx)
			11°	
Fixture Power	9W	1	0.19	2101
Source Flux	121lm	2	0.38	525
Fixture Flux	121lm	3	0.56	233
Efficacy	13lm/W	4	0.75	131
TS1030	I _{max} =1736cd/klm	I _{max}	2101cd	5 0.94 84

Driver	Colour	Code
EL. DMX		1E3112

LED RGBW / 17W 4Ch / FLOOD



		H(m)	D1(m)	D2(m)	E _{max} (lx)
			85°	29°	
Fixture Power	9W	1	1.82	0.52	91
Source Flux	88lm	2	3.65	1.04	23
Fixture Flux	88lm	3	5.47	1.56	10
Efficacy	10lm/W	4	7.29	2.08	6
TS1033	I _{max} =1038cd/klm	I _{max}	91cd	5 9.11 2.60 4	

Driver	Colour	Code
EL. DMX		1E3113

LED RGBW / 17W 4Ch / WALL WASHER



		H(m)	D1(m)	D2(m)	E _{max} (lx)
			115°	55°	
Fixture Power	9W	1	3.17	1.18	95
Source Flux	96lm	2	6.33	2.36	24
Fixture Flux	96lm	3	9.50	3.55	11
Efficacy	11lm/W	4	12.67	4.73	6
TS1036	I _{max} =1163cd/klm	I _{max}	111cd	5 15.83 5.91 4	

Driver	Colour	Code
EL. DMX		1E3114

LED RGBW / 17W 4Ch / GRAZING



		H(m)	D1(m)	D2(m)	E _{max} (lx)
			73°	11°	
Fixture Power	9W	1	1.48	0.19	235
Source Flux	105lm	2	2.97	0.38	59
Fixture Flux	105lm	3	4.45	0.57	26
Efficacy	12lm/W	4	5.94	0.76	15
TS1029	I _{max} =2250cd/klm	I _{max}	235cd	5 7.42 0.96 9	

Driver	Colour	Code
EL. DMX		1E3111

Note

Photometrics show the maximum emission values of fixtures.



Projector RGBW L. 916mm

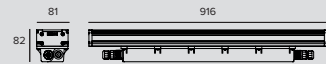

LED RGBW / 26W 4Ch / SPOT



		H(m)	D(m)	E _{max} (lx)
			11°	
Fixture Power	15W	1	0.19	3152
Source Flux	182lm	2	0.38	788
Fixture Flux	181lm	3	0.56	350
Efficacy	12lm/W	4	0.75	197
TS1031	I _{max} =1736cd/klm	I _{max}	3152cd	5 0.94 126

Driver	Colour	Code
EL. DMX		1E3116

LED RGBW / 26W 4Ch / FLOOD



		H(m)	D1(m)	D2(m)	E _{max} (lx)
			85°	29°	
Fixture Power	15W	1	1.82	0.52	136
Source Flux	131lm	2	3.65	1.04	34
Fixture Flux	131lm	3	5.47	1.56	15
Efficacy	9lm/W	4	7.29	2.08	9
TS1034	I _{max} =1038cd/klm	I _{max}	136cd	5 9.11 2.60	5

Driver	Colour	Code
EL. DMX		1E3117

LED RGBW / 26W 4Ch / WALL WASHER



		H(m)	D1(m)	D2(m)	E _{max} (lx)
			115°	55°	
Fixture Power	15W	1	3.17	1.18	142
Source Flux	143lm	2	6.33	2.36	35
Fixture Flux	143lm	3	9.50	3.55	16
Efficacy	10lm/W	4	12.67	4.73	9
TS1037	I _{max} =1163cd/klm	I _{max}	167cd	5 15.83 5.91	6

Driver	Colour	Code
EL. DMX		1E3118

LED RGBW / 26W 4Ch / GRAZING



		H(m)	D1(m)	D2(m)	E _{max} (lx)
			73°	11°	
Fixture Power	15W	1	1.48	0.19	353
Source Flux	157lm	2	2.97	0.38	88
Fixture Flux	157lm	3	4.45	0.57	39
Efficacy	10lm/W	4	5.94	0.76	22
TS1028	I _{max} =2250cd/klm	I _{max}	353cd	5 7.42 0.96	14

Driver	Colour	Code
EL. DMX		1E3115

Note

Photometrics show the maximum emission values of fixtures.



Projector RGBW L. 1216mm

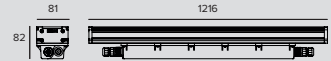

LED RGBW / 34W 4Ch / SPOT ⊕ 4.4 IP66 IP67 IK08

		H(m)	D(m)	E _{max} (lx)
			11°	
Fixture Power	18W	1	0.19	4203
Source Flux	242lm	2	0.38	1051
Fixture Flux	242lm	3	0.56	467
Efficacy	13lm/W	4	0.75	263
TS1032	I _{max} =1736cd/klm	I _{max}	4203cd	168

Driver	Colour	Code
EL. DMX	●	1E3120

LED RGBW / 34W 4Ch / FLOOD ⊕ 4.4 IP66 IP67 IK08

		H(m)	D1(m)	D2(m)	E _{max} (lx)
			85°	29°	
Fixture Power	18W	1	1.82	0.52	182
Source Flux	175lm	2	3.65	1.04	45
Fixture Flux	175lm	3	5.47	1.56	20
Efficacy	10lm/W	4	7.29	2.08	11
TS1035	I _{max} =1038cd/klm	I _{max}	182cd	5 9.11	2.60 7

Driver	Colour	Code
EL. DMX	●	1E3121

LED RGBW / 34W 4Ch / WALL WASHER ⊕ 4.4 IP66 IP67 IK08

		H(m)	D1(m)	D2(m)	E _{max} (lx)
			115°	55°	
Fixture Power	18W	1	3.17	1.18	189
Source Flux	191lm	2	6.33	2.36	47
Fixture Flux	191lm	3	9.50	3.55	21
Efficacy	11lm/W	4	12.67	4.73	12
TS1038	I _{max} =1163cd/klm	I _{max}	222cd	5 15.83	5.91 8

Driver	Colour	Code
EL. DMX	●	1E3122

LED RGBW / 34W 4Ch / GRAZING ⊕ 4.4 IP66 IP67 IK08

		H(m)	D1(m)	D2(m)	E _{max} (lx)
			73°	11°	
Fixture Power	18W	1	1.48	0.19	471
Source Flux	209lm	2	2.97	0.38	118
Fixture Flux	209lm	3	4.45	0.57	52
Efficacy	12lm/W	4	5.94	0.76	29
TS1027	I _{max} =2250cd/klm	I _{max}	471cd	5 7.42	0.96 19

Driver	Colour	Code
EL. DMX	●	1E3119

Note

Photometrics show the maximum emission values of fixtures.

Related codes

Mounting System

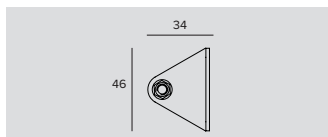

Code
1E2752

Short bracket for wall installation (2 pieces).

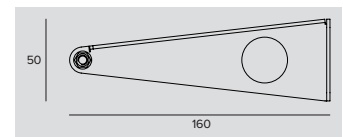

Code
1E2753

Long bracket for wall installation (2 pieces).

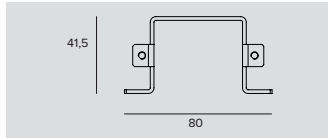

Code

1E2754

Bracket for ceiling installation (2 pieces).

Accessories

End Caps



Code

1E2761

End cap.

Connector

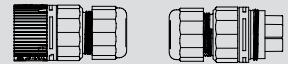

Code

1E2769

Connectors kit for 5 pole coaxial connections.

Cover Panel

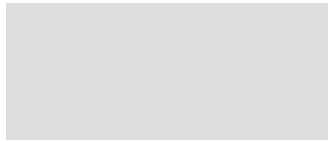

L Code

616 **1E3045**

916 **1E3046**

1216 **1E3047**

Side cover for ceiling installation.

Connector



Code

1E3184

DMX connection.

Cover Panel

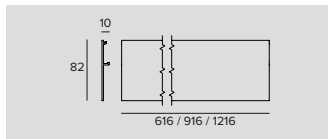

L Code

616 **1E2755**

916 **1E2756**

1216 **1E2757**

Side cover for wall/cornice installation.

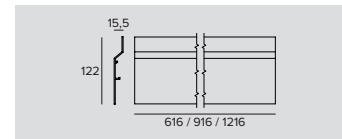

L Code

616 **1E2758**

916 **1E2759**

1216 **1E2760**

Anti-glare side cover.

Control systems



Code

1E2767

USB-RDM Programmer code.

DMX-RDM (Remote Device Management) address planner.

Used with the "RDM Targetti" software that can be downloaded for free from the Targetti website download section.

To be used with all RGBW products.

JEDI

Compact

GENERAL INFO

Adjustable linear projector.
50x40mm (remote driver)
50x80mm (integrated driver)
Lengths 300mm – 600mm – 900mm 1200mm

LED

Linear boards
Da 1615lm a 7200lm
2700K – 3000K – 3500K – 4000K
Ra84

PRODUCT EFFICACY

Until 113lm/W

OPTICS

FL – GRAZING – WALL WASHER

POWER SUPPLY

Electronic – DALI
Casambi control: the DALI version is fitted with special accessories.

MATERIAL

Extruded anodised aluminium body. Extra clear glass flat screen.

A compact, high performance linear LED fixture suitable for installation in small grooves or on particularly thin frames. Depending on the chosen optic it is suitable for general lighting in pedestrian areas, vaulted ceilings and vertical surfaces. Available also in a double version with an integrated or remote driver with an extremely thin profile of just 5x4mm.

If equipped with special brackets the projector can be adjusted up to $\pm 90^\circ$.

The L. 300mm version is only available with a remote driver.

Also available recessed version.





Catedral de Valledupar

Architect
Gustavo Vasquez

Country
Valledupar,
Colombia

Photographer
Sebastian Franco

01

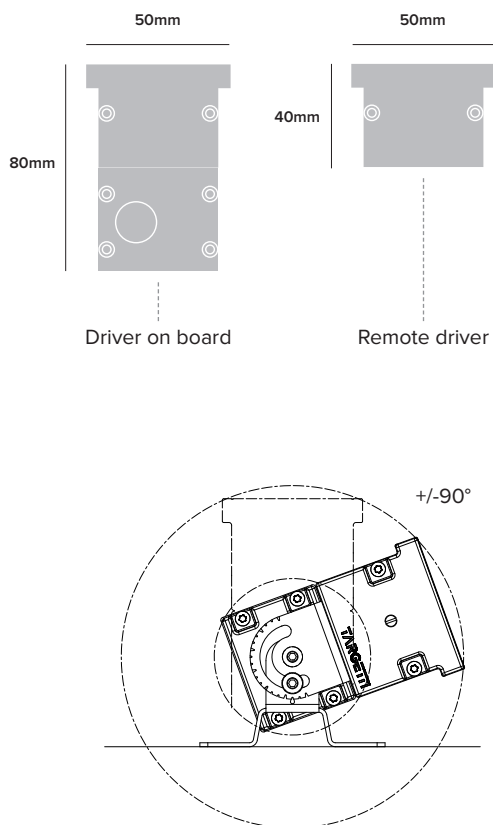

02



Compact size and adjustability

There are two profiles to choose from depending on the characteristics of the installation surface: with a remote driver where it is necessary to have a compact profile, or with an integrated driver when space permits and priority is given to connection speed. Furthermore, thanks to the special brackets that are available in two different lengths, the projector can be rotated from -90° to $+90^\circ$ with aim locking using an Allen key for maximum reliability in the installation phase.

Anti-glare multiple effects

A grazing light effect using the grazing optic, a uniform lighting effect on wide and high surfaces using the wall washer optic and a more concentrated effect with the Flood optic. Where it is necessary to limit the risk of glare the three optical solutions are also available already equipped with a LOUVRE, a particular anti-glare grid that limits lateral light emission.



IP67 Remote driver L. 312.5mm

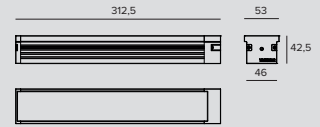

LED / 12W / FLOOD



	3000K	H(m)	D1(m)	D2(m)	E _{max} (lx)		
Ra84			85°	32°			
Fixture Power	14W	1	1.84	0.57	1203		
Source Flux	1720lm	2	3.68	1.14	301		
Fixture Flux	1285lm	3	5.52	1.70	134		
Efficacy	92lm/W	4	7.36	2.27	75		
TS1084	I _{max} =699cd/klm	I _{max}	1203cd	5	9.20	2.84	48

Driver	Colour	2700K	3000K	3500K	4000K
	●	1E3220	1E3221	1E3222	1E3223

LED / 12W / GRAZING

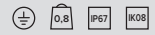

	3000K	H(m)	D1(m)	D2(m)	E _{max} (lx)		
Ra84			76°	15°			
Fixture Power	14W	1	1.55	0.26	2752		
Source Flux	1720lm	2	3.10	0.51	688		
Fixture Flux	1429lm	3	4.65	0.77	306		
Efficacy	102lm/W	4	6.21	1.02	172		
TS1088	I _{max} =1600cd/klm	I _{max}	2752cd	5	7.76	1.28	110

Driver	Colour	2700K	3000K	3500K	4000K
	●	1E3224	1E3225	1E3226	1E3227

LED / 12W / WALL WASHER



	3000K	H(m)	D1(m)	D2(m)	E _{max} (lx)		
Ra84			115°	59°			
Fixture Power	14W	1	3.12	1.34	1156		
Source Flux	1720lm	2	6.23	2.67	289		
Fixture Flux	1293lm	3	9.35	4.01	128		
Efficacy	92lm/W	4	12.47	5.35	72		
TS1092	I _{max} =774cd/klm	I _{max}	1331cd	5	15.59	6.69	46

Driver	Colour	2700K	3000K	3500K	4000K
	●	1E3228	1E3229	1E3230	1E3231



IP67 Louvre Remote driver L. 312.5mm

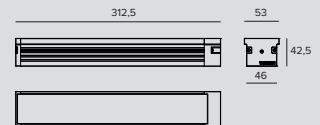

LED / 12W / FLOOD



	3000K	H(m)	D1(m)	D2(m)	E _{max} (lx)		
Ra84			86°	29°			
Fixture Power	14W	1	1.86	0.52	873		
Source Flux	1720lm	2	3.71	1.05	218		
Fixture Flux	752lm	3	5.57	1.57	97		
Efficacy	54lm/W	4	7.42	2.09	55		
TS1086	I _{max} =508cd/klm	I _{max}	873cd	5	9.28	2.62	35

Power supply	Colour	2700K	3000K	3500K	4000K
500mA	●	1E3307	1E3308	1E3309	1E3310

JEDI COMPACT

LED / 12W / GRAZING

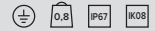

		3000K	H(m)	D1(m)	D2(m)	E _{max} (lx)
Ra84			80°	13°		
Fixture Power	14W	1	1.68	0.23	1903	
Source Flux	1720lm	2	3.36	0.46	476	
Fixture Flux	912lm	3	5.04	0.68	211	
Efficacy	65lm/W	4	6.72	0.91	119	
TS1090	I _{max} =1106cd/klm	I _{max}	1903cd	5	8.40	1.14 76

Power supply	Colour	2700K	3000K	3500K	4000K
500mA	●	1E3311	1E3312	1E3313	1E3314

LED / 12W / WALL WASHER



		3000K	H(m)	D1(m)	D2(m)	E _{max} (lx)
Ra84			116°	62°		
Fixture Power	14W	1	3.17	1.49	960	
Source Flux	1720lm	2	6.35	2.97	240	
Fixture Flux	975lm	3	9.52	4.46	107	
Efficacy	70lm/W	4	12.70	5.95	60	
TS1094	I _{max} =671cd/klm	I _{max}	1153cd	5	15.87	7.43 38

Power supply	Colour	2700K	3000K	3500K	4000K
500mA	●	1E3315	1E3316	1E3317	1E3318



IP67
Remote driver L. 593.5mm

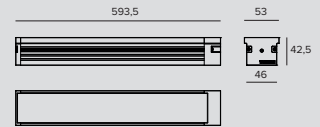

LED / 24W / FLOOD



		3000K	H(m)	D1(m)	D2(m)	E _{max} (lx)
Ra84			85°	32°		
Fixture Power	28W	1	1.84	0.57	2406	
Source Flux	3440lm	2	3.68	1.14	601	
Fixture Flux	2570lm	3	5.52	1.70	267	
Efficacy	92lm/W	4	7.36	2.27	150	
TS1084	I _{max} =699cd/klm	I _{max}	2406cd	5	9.20	2.84 96

Power supply	Colour	2700K	3000K	3500K	4000K
500mA	●	1E3232	1E3233	1E3234	1E3235

LED / 24W / GRAZING

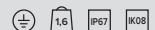

		3000K	H(m)	D1(m)	D2(m)	E _{max} (lx)
Ra84			76°	15°		
Fixture Power	28W	1	1.55	0.26	5505	
Source Flux	3440lm	2	3.10	0.51	1376	
Fixture Flux	2858lm	3	4.65	0.77	612	
Efficacy	102lm/W	4	6.21	1.02	344	
TS1088	I _{max} =1600cd/klm	I _{max}	5505cd	5	7.76	1.28 220

Power supply	Colour	2700K	3000K	3500K	4000K
500mA	●	1E3236	1E3237	1E3238	1E3239

LED / 24W / WALL WASHER



		3000K	H(m)	D1(m)	D2(m)	E _{max} (lx)
Ra84			115°	59°		
Fixture Power	28W	1	3.12	1.34	2312	
Source Flux	3440lm	2	6.23	2.67	578	
Fixture Flux	2586lm	3	9.35	4.01	257	
Efficacy	92lm/W	4	12.47	5.35	145	
TS1092	I _{max} =774cd/klm	I _{max}	2661cd	5	15.59	6.69 92

Power supply	Colour	2700K	3000K	3500K	4000K
500mA	●	1E3240	1E3241	1E3242	1E3243



IP67 Louvre Remote driver L. 593.5mm

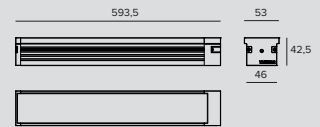

LED / 24W / FLOOD							
	3000K	H(m)	D1(m)	D2(m)	E _{max} (lx)		
	Ra84		86°	29°			
	Fixture Power	28W	1	1.86	0.52	1747	
	Source Flux	3440lm	2	3.71	1.05	437	
	Fixture Flux	1503lm	3	5.57	1.57	194	
	Efficacy	54lm/W	4	7.42	2.09	109	
TS1086	I _{max} =508cd/klm	I _{max}	1747cd	5	9.28	2.62	70
Power supply	Colour	2700K	3000K	3500K	4000K		
500mA		1E3319	1E3320	1E3321	1E3322		

LED / 24W / GRAZING							
	3000K	H(m)	D1(m)	D2(m)	E _{max} (lx)		
	Ra84		80°	13°			
	Fixture Power	28W	1	1.68	0.23	3805	
	Source Flux	3440lm	2	3.36	0.46	951	
	Fixture Flux	1824lm	3	5.04	0.68	423	
	Efficacy	65lm/W	4	6.72	0.91	238	
TS1090	I _{max} =1106cd/klm	I _{max}	3805cd	5	8.40	1.14	152
Power supply	Colour	2700K	3000K	3500K	4000K		
500mA		1E3323	1E3324	1E3325	1E3326		

LED / 24W / WALL WASHER							
	3000K	H(m)	D1(m)	D2(m)	E _{max} (lx)		
	Ra84		116°	62°			
	Fixture Power	28W	1	3.17	1.49	1919	
	Source Flux	3440lm	2	6.35	2.97	480	
	Fixture Flux	1950lm	3	9.52	4.46	213	
	Efficacy	70lm/W	4	12.70	5.95	120	
TS1094	I _{max} =671cd/klm	I _{max}	2307cd	5	15.87	7.43	77
Power supply	Colour	2700K	3000K	3500K	4000K		
500mA		1E3327	1E3328	1E3329	1E3330		



IP67 Remote driver L. 873.5mm

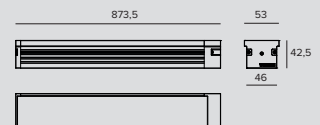

LED / 36W / FLOOD							
	3000K	H(m)	D1(m)	D2(m)	E _{max} (lx)		
	Ra84		85°	32°			
	Fixture Power	40W	1	1.84	0.57	3609	
	Source Flux	5160lm	2	3.68	1.14	902	
	Fixture Flux	3856lm	3	5.52	1.70	401	
	Efficacy	96lm/W	4	7.36	2.27	226	
TS1085	I _{max} =699cd/klm	I _{max}	3609cd	5	9.20	2.84	144
Power supply	Colour	2700K	3000K	3500K	4000K		
500mA		1E3244	1E3245	1E3246	1E3247		

JEDI COMPACT

LED / 36W / GRAZING



		3000K	H(m)	D1(m)	D2(m)	E _{max} (lx)	
Ra84			76°	15°			
Fixture Power	40W	1	1.55	0.26	8259		
Source Flux	5160lm	2	3.10	0.51	2065		
Fixture Flux	4288lm	3	4.65	0.77	918		
Efficacy	107lm/W	4	6.21	1.02	516		
TS1089	I _{max} =1601cd/klm	I _{max}	8259cd	5	7.76	1.28	330

Power supply	Colour	2700K	3000K	3500K	4000K
500mA	●	1E3248	1E3249	1E3250	1E3251

LED / 36W / WALL WASHER



		3000K	H(m)	D1(m)	D2(m)	E _{max} (lx)	
Ra84			115°	59°			
Fixture Power	40W	1	3.12	1.34	3469		
Source Flux	5160lm	2	6.23	2.67	867		
Fixture Flux	3880lm	3	9.35	4.01	385		
Efficacy	97lm/W	4	12.47	5.35	217		
TS1093	I _{max} =774cd/klm	I _{max}	3992cd	5	15.59	6.69	139

Power supply	Colour	2700K	3000K	3500K	4000K
500mA	●	1E3252	1E3253	1E3254	1E3255



IP67 Louvre
Remote driver L. 873.5mm

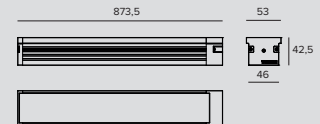

LED / 36W / FLOOD



		3000K	H(m)	D1(m)	D2(m)	E _{max} (lx)	
Ra84			86°	29°			
Fixture Power	40W	1	1.86	0.52	2620		
Source Flux	5160lm	2	3.71	1.05	655		
Fixture Flux	2255lm	3	5.57	1.57	291		
Efficacy	56lm/W	4	7.42	2.09	164		
TS1087	I _{max} =508cd/klm	I _{max}	2620cd	5	9.28	2.62	105

Power supply	Colour	2700K	3000K	3500K	4000K
500mA	●	1E3331	1E3332	1E3333	1E3334

LED / 36W / GRAZING



		3000K	H(m)	D1(m)	D2(m)	E _{max} (lx)	
Ra84			80°	13°			
Fixture Power	40W	1	1.68	0.23	5707		
Source Flux	5160lm	2	3.36	0.46	1427		
Fixture Flux	2735lm	3	5.04	0.68	634		
Efficacy	68lm/W	4	6.72	0.91	357		
TS1091	I _{max} =1106cd/klm	I _{max}	5707cd	5	8.40	1.14	228

Power supply	Colour	2700K	3000K	3500K	4000K
500mA	●	1E3335	1E3336	1E3337	1E3338

LED / 36W / WALL WASHER

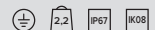

		3000K	H(m)	D1(m)	D2(m)	E _{max} (lx)	
Ra84			116°	52°			
Fixture Power	40W	1	3.17	1.49	2879		
Source Flux	5160lm	2	6.35	2.97	720		
Fixture Flux	2926lm	3	9.52	4.46	320		
Efficacy	73lm/W	4	12.70	5.95	180		
TS1095	I _{max} =671cd/klm	I _{max}	3460cd	5	15.87	7.43	115

Power supply	Colour	2700K	3000K	3500K	4000K
500mA	●	1E3339	1E3340	1E3341	1E3342



IP67 Remote driver L. 1153.5mm

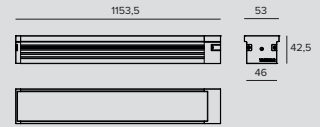

LED / 48W / FLOOD						⊥	3.2	IP67	IK08		
	3000K	H(m)	D1(m)	D2(m)	E _{max} (lx)	Power supply	Colour	2700K	3000K	3500K	4000K
	Ra84		85°	32°		500mA	●	1E3256	1E3257	1E3258	1E3259
	Fixture Power	53W	1	1.84	0.57	4812					
	Source Flux	6880lm	2	3.68	1.14	1203					
	Fixture Flux	5141lm	3	5.52	1.70	535					
	Efficacy	97lm/W	4	7.36	2.27	301					
TS1085	I _{max} =699cd/klm	I _{max}	4812cd	5	9.20	2.84	192				

LED / 48W / GRAZING						⊥	3.2	IP67	IK08		
	3000K	H(m)	D1(m)	D2(m)	E _{max} (lx)	Power supply	Colour	2700K	3000K	3500K	4000K
	Ra84		76°	15°		500mA	●	1E3260	1E3261	1E3262	1E3263
	Fixture Power	53W	1	1.55	0.26	11012					
	Source Flux	6880lm	2	3.10	0.51	2753					
	Fixture Flux	5717lm	3	4.65	0.77	1224					
	Efficacy	108lm/W	4	6.21	1.02	688					
TS1089	I _{max} =1601cd/klm	I _{max}	11012cd	5	7.76	1.28	440				

LED / 48W / WALL WASHER						⊥	3.2	IP67	IK08		
	3000K	H(m)	D1(m)	D2(m)	E _{max} (lx)	Power supply	Colour	2700K	3000K	3500K	4000K
	Ra84		115°	59°		500mA	●	1E3264	1E3265	1E3266	1E3267
	Fixture Power	53W	1	3.12	1.34	4625					
	Source Flux	6880lm	2	6.23	2.67	1156					
	Fixture Flux	5173lm	3	9.35	4.01	514					
	Efficacy	98lm/W	4	12.47	5.35	289					
TS1093	I _{max} =774cd/klm	I _{max}	5323cd	5	15.59	6.69	185				



IP67 Louvre Remote driver L. 1153.5mm

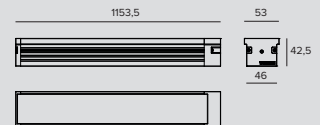

LED / 48W / FLOOD						⊥	3.2	IP67	IK08		
	3000K	H(m)	D1(m)	D2(m)	E _{max} (lx)	Power supply	Colour	2700K	3000K	3500K	4000K
	Ra84		86°	29°		500mA	●	1E3343	1E3344	1E3345	1E3346
	Fixture Power	53W	1	1.86	0.52	3494					
	Source Flux	6880lm	2	3.71	1.05	873					
	Fixture Flux	3007lm	3	5.57	1.57	388					
	Efficacy	57lm/W	4	7.42	2.09	218					
TS1087	I _{max} =508cd/klm	I _{max}	3494cd	5	9.28	2.62	140				

JEDI COMPACT

LED / 48W / GRAZING



		3000K	H(m)	D1(m)	D2(m)	E _{max} (lx)
Ra84			80°	13°		
Fixture Power	53W	1	1.68	0.23	7609	
Source Flux	6880lm	2	3.36	0.46	1902	
Fixture Flux	3646lm	3	5.04	0.68	845	
Efficacy	69lm/W	4	6.72	0.91	476	
TS1091	I _{max} =1106cd/klm	I _{max}	7609cd	5	8.40	1.14 304

Power supply	Colour	2700K	3000K	3500K	4000K
500mA	●	1E3347	1E3348	1E3349	1E3350

LED / 48W / WALL WASHER



		3000K	H(m)	D1(m)	D2(m)	E _{max} (lx)
Ra84			116°	62°		
Fixture Power	53W	1	3.17	1.49	3838	
Source Flux	6880lm	2	6.35	2.97	960	
Fixture Flux	3901lm	3	9.52	4.46	426	
Efficacy	74lm/W	4	12.70	5.95	240	
TS1095	I _{max} =671cd/klm	I _{max}	4613cd	5	15.87	7.43 154

Power supply	Colour	2700K	3000K	3500K	4000K
500mA	●	1E3351	1E3352	1E3353	1E3354



IP67
Integrated driver L. 576mm

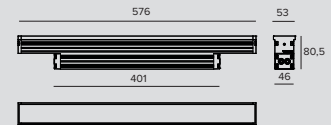

LED / 24W / FLOOD



		3000K	H(m)	D1(m)	D2(m)	E _{max} (lx)
Ra84			85°	32°		
Fixture Power	28W	1	1.84	0.57	2406	
Source Flux	3440lm	2	3.68	1.14	601	
Fixture Flux	2570lm	3	5.52	1.70	267	
Efficacy	92lm/W	4	7.36	2.27	150	
TS1084	I _{max} =699cd/klm	I _{max}	2406cd	5	9.20	2.84 96

Driver	Colour	2700K	3000K	3500K	4000K
EL.	●	1E3268EL	1E3269EL	1E3270EL	1E3271EL
DALI	●	1E3268DA	1E3269DA	1E3270DA	1E3271DA

LED / 24W / GRAZING



		3000K	H(m)	D1(m)	D2(m)	E _{max} (lx)
Ra84			76°	15°		
Fixture Power	28W	1	1.55	0.26	5505	
Source Flux	3440lm	2	3.10	0.51	1376	
Fixture Flux	2858lm	3	4.65	0.77	612	
Efficacy	102lm/W	4	6.21	1.02	344	
TS1088	I _{max} =1600cd/klm	I _{max}	5505cd	5	7.76	1.28 220

Driver	Colour	2700K	3000K	3500K	4000K
EL.	●	1E3272EL	1E3273EL	1E3274EL	1E3275EL
DALI	●	1E3272DA	1E3273DA	1E3274DA	1E3275DA

LED / 24W / WALL WASHER

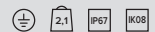

		3000K	H(m)	D1(m)	D2(m)	E _{max} (lx)
Ra84			115°	59°		
Fixture Power	28W	1	3.12	1.34	2312	
Source Flux	3440lm	2	6.23	2.67	578	
Fixture Flux	2586lm	3	9.35	4.01	257	
Efficacy	92lm/W	4	12.47	5.35	145	
TS1092	I _{max} =774cd/klm	I _{max}	2661cd	5	15.59	6.69 92

Driver	Colour	2700K	3000K	3500K	4000K
EL.	●	1E3276EL	1E3277EL	1E3278EL	1E3279EL
DALI	●	1E3276DA	1E3277DA	1E3278DA	1E3279DA

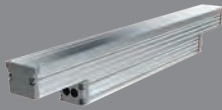

IP67 Louvre Integrated driver L. 576mm

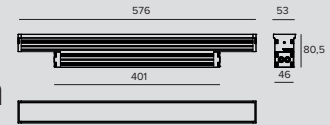

LED / 24W / FLOOD



	3000K	H(m)	D1(m)	D2(m)	E _{max} (lx)		
Ra84			86°	29°			
Fixture Power	28W	1	1.86	0.52	1747		
Source Flux	3440lm	2	3.71	1.05	437		
Fixture Flux	1503lm	3	5.57	1.57	194		
Efficacy	54lm/W	4	7.42	2.09	109		
TS1086	Imax=508cd/klm	Imax	1747cd	5	9.28	2.62	70

Driver	Colour	2700K	3000K	3500K	4000K
EL.	●	1E3355EL	1E3356EL	1E3357EL	1E3358EL
DALI	●	1E3355DA	1E3356DA	1E3357DA	1E3358DA

LED / 24W / GRAZING



	3000K	H(m)	D1(m)	D2(m)	E _{max} (lx)		
Ra84			80°	13°			
Fixture Power	28W	1	1.68	0.23	3805		
Source Flux	3440lm	2	3.36	0.46	951		
Fixture Flux	1824lm	3	5.04	0.68	423		
Efficacy	65lm/W	4	6.72	0.91	238		
TS1090	Imax=1106cd/klm	Imax	3805cd	5	8.40	1.14	152

Driver	Colour	2700K	3000K	3500K	4000K
EL.	●	1E3359EL	1E3360EL	1E3361EL	1E3362EL
DALI	●	1E3359DA	1E3360DA	1E3361DA	1E3362DA

LED / 24W / WALL WASHER



	3000K	H(m)	D1(m)	D2(m)	E _{max} (lx)		
Ra84			116°	62°			
Fixture Power	28W	1	3.17	1.49	1919		
Source Flux	3440lm	2	6.35	2.97	480		
Fixture Flux	1950lm	3	9.52	4.46	213		
Efficacy	70lm/W	4	12.70	5.95	120		
TS1094	Imax=671cd/klm	Imax	2307cd	5	15.87	7.43	77

Driver	Colour	2700K	3000K	3500K	4000K
EL.	●	1E3363EL	1E3364EL	1E3365EL	1E3366EL
DALI	●	1E3363DA	1E3364DA	1E3365DA	1E3366DA

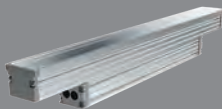

IP67 Integrated driver L. 856mm

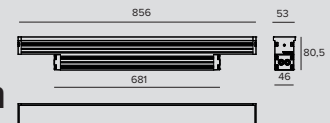

LED / 36W / FLOOD



	3000K	H(m)	D1(m)	D2(m)	E _{max} (lx)		
Ra84			85°	32°			
Fixture Power	40W	1	1.84	0.57	3609		
Source Flux	5160lm	2	3.68	1.14	902		
Fixture Flux	3856lm	3	5.52	1.70	401		
Efficacy	96lm/W	4	7.36	2.27	226		
TS1085	Imax=699cd/klm	Imax	3609cd	5	9.20	2.84	144

Driver	Colour	2700K	3000K	3500K	4000K
EL.	●	1E3280EL	1E3281EL	1E3282EL	1E3283EL
DALI	●	1E3280DA	1E3281DA	1E3282DA	1E3283DA

JEDI COMPACT

LED / 36W / GRAZING



		3000K	H(m)	D1(m)	D2(m)	E _{max} (lx)	
Ra84			76°	15°			
Fixture Power	40W	1	1.55	0.26	8259		
Source Flux	5160lm	2	3.10	0.51	2065		
Fixture Flux	4288lm	3	4.65	0.77	918		
Efficacy	107lm/W	4	6.21	1.02	516		
TS1089	I _{max} =1601cd/klm	I _{max}	8259cd	5	7.76	1.28	330

Driver	Colour	2700K	3000K	3500K	4000K
EL.	●	1E3284EL	1E3285EL	1E3286EL	1E3287EL
DALI	●	1E3284DA	1E3285DA	1E3286DA	1E3287DA

LED / 36W / WALL WASHER

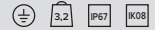

		3000K	H(m)	D1(m)	D2(m)	E _{max} (lx)	
Ra84			115°	59°			
Fixture Power	40W	1	3.12	1.34	3469		
Source Flux	5160lm	2	6.23	2.67	867		
Fixture Flux	3880lm	3	9.35	4.01	385		
Efficacy	97lm/W	4	12.47	5.35	217		
TS1093	I _{max} =774cd/klm	I _{max}	3992cd	5	15.59	6.69	139

Driver	Colour	2700K	3000K	3500K	4000K
EL.	●	1E3288EL	1E3289EL	1E3290EL	1E3291EL
DALI	●	1E3288DA	1E3289DA	1E3290DA	1E3291DA



**IP67 Louvre
Integrated driver L. 856mm**

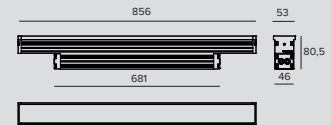

LED / 36W / FLOOD



		3000K	H(m)	D1(m)	D2(m)	E _{max} (lx)	
Ra84			86°	29°			
Fixture Power	40W	1	1.86	0.52	2620		
Source Flux	5160lm	2	3.71	1.05	655		
Fixture Flux	2255lm	3	5.57	1.57	291		
Efficacy	56lm/W	4	7.42	2.09	164		
TS1087	I _{max} =508cd/klm	I _{max}	2620cd	5	9.28	2.62	105

Driver	Colour	2700K	3000K	3500K	4000K
EL.	●	1E3367EL	1E3368EL	1E3369EL	1E3370EL
DALI	●	1E3367DA	1E3368DA	1E3369DA	1E3370DA

LED / 36W / GRAZING

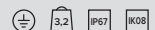

		3000K	H(m)	D1(m)	D2(m)	E _{max} (lx)	
Ra84			80°	13°			
Fixture Power	40W	1	1.68	0.23	5707		
Source Flux	5160lm	2	3.36	0.46	1427		
Fixture Flux	2735lm	3	5.04	0.68	634		
Efficacy	68lm/W	4	6.72	0.91	357		
TS1091	I _{max} =1106cd/klm	I _{max}	5707cd	5	8.40	1.14	228

Driver	Colour	2700K	3000K	3500K	4000K
EL.	●	1E3371EL	1E3372EL	1E3373EL	1E3374EL
DALI	●	1E3371DA	1E3372DA	1E3373DA	1E3374DA

LED / 36W / WALL WASHER

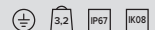

		3000K	H(m)	D1(m)	D2(m)	E _{max} (lx)	
Ra84			116°	52°			
Fixture Power	40W	1	3.17	1.49	2879		
Source Flux	5160lm	2	6.35	2.97	720		
Fixture Flux	2926lm	3	9.52	4.46	320		
Efficacy	73lm/W	4	12.70	5.95	180		
TS1095	I _{max} =671cd/klm	I _{max}	3460cd	5	15.87	7.43	115

Driver	Colour	2700K	3000K	3500K	4000K
EL.	●	1E3375EL	1E3376EL	1E3377EL	1E3378EL
DALI	●	1E3375DA	1E3376DA	1E3377DA	1E3378DA

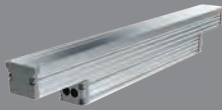

IP67 Integrated driver L. 1136mm

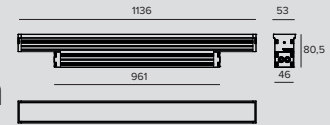

LED / 48W / FLOOD



	3000K	H(m)	D1(m)	D2(m)	E _{max} (lx)		
Ra84			85°	32°			
Fixture Power	53W	1	1.84	0.57	4812		
Source Flux	6880lm	2	3.68	1.14	1203		
Fixture Flux	5141lm	3	5.52	1.70	535		
Efficacy	97lm/W	4	7.36	2.27	301		
TS1085	Imax=699cd/klm	Imax	4812cd	5	9.20	2.84	192

Driver	Colour	2700K	3000K	3500K	4000K
EL.	●	1E3292EL	1E3293EL	1E3294EL	1E3295EL
DALI	●	1E3292DA	1E3293DA	1E3294DA	1E3295DA

LED / 48W / GRAZING



	3000K	H(m)	D1(m)	D2(m)	E _{max} (lx)		
Ra84			76°	15°			
Fixture Power	53W	1	1.55	0.26	11012		
Source Flux	6880lm	2	3.10	0.51	2753		
Fixture Flux	5717lm	3	4.65	0.77	1224		
Efficacy	108lm/W	4	6.21	1.02	688		
TS1089	Imax=1601cd/klm	Imax	11012cd	5	7.76	1.28	440

Driver	Colour	2700K	3000K	3500K	4000K
EL.	●	1E3296EL	1E3297EL	1E3298EL	1E3299EL
DALI	●	1E3296DA	1E3297DA	1E3298DA	1E3299DA

LED / 48W / WALL WASHER



	3000K	H(m)	D1(m)	D2(m)	E _{max} (lx)		
Ra84			115°	59°			
Fixture Power	53W	1	3.12	1.34	4625		
Source Flux	6880lm	2	6.23	2.67	1156		
Fixture Flux	5173lm	3	9.35	4.01	514		
Efficacy	98lm/W	4	12.47	5.35	289		
TS1093	Imax=774cd/klm	Imax	5323cd	5	15.59	6.69	185

Driver	Colour	2700K	3000K	3500K	4000K
EL.	●	1E3300EL	1E3301EL	1E3302EL	1E3303EL
DALI	●	1E3300DA	1E3301DA	1E3302DA	1E3303DA

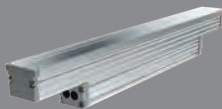

IP67 Louvre Integrated driver L. 1136mm

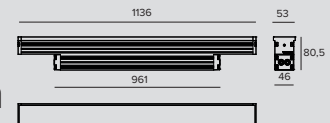

LED / 48W / FLOOD



	3000K	H(m)	D1(m)	D2(m)	E _{max} (lx)		
Ra84			86°	29°			
Fixture Power	53W	1	1.86	0.52	3494		
Source Flux	6880lm	2	3.71	1.05	873		
Fixture Flux	3007lm	3	5.57	1.57	388		
Efficacy	57lm/W	4	7.42	2.09	218		
TS1087	Imax=508cd/klm	Imax	3494cd	5	9.28	2.62	140

Driver	Colour	2700K	3000K	3500K	4000K
EL.	●	1E3379EL	1E3380EL	1E3381EL	1E3382EL
DALI	●	1E3379DA	1E3380DA	1E3381DA	1E3382DA

JEDI COMPACT

LED / 48W / GRAZING



		3000K	H(m)	D1(m)	D2(m)	E _{max} (lx)	
Ra84				80°	13°		
Fixture Power	53W	1	1.68	0.23	7609		
Source Flux	6880lm	2	3.36	0.46	1902		
Fixture Flux	3646lm	3	5.04	0.68	845		
Efficacy	69lm/W	4	6.72	0.91	476		
TS1091	I _{max} =1106cd/klm	I _{max}	7609cd	5	8.40	1.14	304

Driver	Colour	2700K	3000K	3500K	4000K
EL.		1E3383EL	1E3384EL	1E3385EL	1E3386EL
DALI		1E3383DA	1E3384DA	1E3385DA	1E3386DA

LED / 48W / WALL WASHER



		3000K	H(m)	D1(m)	D2(m)	E _{max} (lx)	
Ra84				116°	62°		
Fixture Power	53W	1	3.17	1.49	3838		
Source Flux	6880lm	2	6.35	2.97	960		
Fixture Flux	3901lm	3	9.52	4.46	426		
Efficacy	74lm/W	4	12.70	5.95	240		
TS1095	I _{max} =671cd/klm	I _{max}	4613cd	5	15.87	7.43	154

Driver	Colour	2700K	3000K	3500K	4000K
EL.		1E3387EL	1E3388EL	1E3389EL	1E3390EL
DALI		1E3387DA	1E3388DA	1E3389DA	1E3390DA

Related codes

Bracket

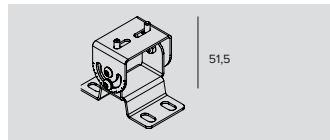

Code

1E3304

Short bracket kit for surface installation (2 pieces).
Rotation +/-90°.

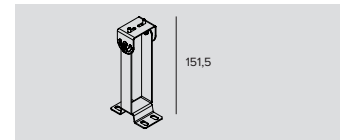

Code

1E3306

Long bracket kit for surface installation (2 pieces).
Rotation +/-90°.

Power Supply



Code

1E3557

EL power supply version kit composed of a aluminium watertight box (LxHxP=270x49.5x44mm) complete with power supply input cable (1 metre, type H07RN-F, 3G1mm²) and an output cable to the fixture (1 metre, type H07RN-F, 3G1mm²).
For the L 312.5/344mm versions.



Code

1E3558

EL power supply version kit composed of a aluminium watertight box (LxHxP=486x49.5x44mm) complete with power supply input cable (1 metre, type H07RN-F, 3G1mm²) and an output cable to the fixture (1 metre, type H07RN-F, 3G1mm²).
For the L 593.5/625/873.5/905/1153.5/1185mm versions.



Code

1E3559

DALI power supply version kit composed of a aluminium watertight box (LxHxP=486x49.5x44mm) complete with power supply input cable (1 metre, type H07RN-F, 5G1mm²) and an output cable to the fixture (1 metre, type H07RN-F, 3G1mm²).
For the L 312.5/344/593.5/625mm versions.



Code

1E3560

DALI power supply version kit composed of a aluminium watertight box (LxHxP=486x49.5x44mm) complete with power supply input cable (1 metre, type H07RN-F, 5G1mm²) and an output cable to the fixture (1 metre, type H07RN-F, 3G1mm²).
For the L 873.5/905/1153.5/1185mm versions.

Accessories

Tool	
	
	Code
	1E3305
(Tightening) wrench for the connector kit.	

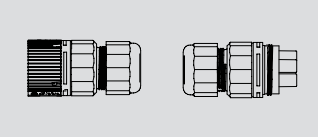
Connector	
	
	Code
	1E2769
Connectors kit for 5 pole coaxial connections.	

Control systems	
	
	Code
	1E3048
A IP67 Module for individual control of external devices equipped with DALI drivers. The module needs to be positioned in order to receive radio signals. The distance to the lighting fixtures can reach up to 50m.	

	
	Code
	1E3049
IP67 Extender for wireless control of DALI fixtures. It generates a local DALI bus with the capacity to drive up to 64 fixtures. Can control DALI fixtures in outdoor applications.	

DART

GENERAL INFO

Professional adjustable projector
76x76 - 134x134 - 214x214

LED

Chip on board
Emitter for versions NSP Small e Medium
From 200lm to 8978lm
3000K – 4000K
Ra80 – Ra84

PRODUCT EFFICACY

Until 110lm/W

OPTICS

NSP – SP – FL – MWFL for all versions.
WFL – ASYM for versions Medium e Maxi
NARROW ASYM for versions Medium

POWER SUPPLY

Electronic – DALI – 1-10V
Casambi control: the DALI version is fitted with special accessories.

MATERIAL

Painted die-cast anodised aluminium body and painted stainless steel mounting bracket.

A range of professional al projectors for outdoor architectural lighting, available in three different sizes-Small, Medium and Maxi; it has a compact and essential design that integrates into every architectural context.

DART is extremely versatile thanks to the possibility to choose from different versions with different lumens and optics for accent lighting or uniform lighting of large surfaces. Also available with an asymmetrical optic.

		SMALL	MEDIUM	MAXI
		Ø 76x76mm	Ø 134x134mm	Ø 214x214mm
LED	Flux (lm)	200-1869	1332-4628	3273-8978
	Power	3W - 12W	16W - 34W	26W - 80W

OPTICS

NSP	Lens	•	•	
	Indirect			•
SP	Lens	•		
	Hybrid		•	•
FL	Lens	•		
	Hybrid		•	•
MWFL	Reflector	•	•	•
WFL	Reflector		•	•
ASYM	Reflector		•	•
NASYM	Reflector		•	





Abbaye de Maubuisson

Architect
YCA Yves
Chemineau
Architecte

**Architect for the
heritage**
Valari Architecte
Aristide Bravaccio

Photographer
Bruno Singer

Country
Saint-Ouen
l'Aumone, France

01



The large version in the DART range

Is designed for architectural lighting of large surfaces and where it is essential to install fixtures at a distance.

DART MAXI has the NSP optic to have clean, precise 6° beams. It works by reflection which means the lamp is hidden from sight and aimed towards the parabolic reflector which collimates the beam and emits a particularly defined, precise cone of light.

02



DART MEDIUM is available with two asymmetrical optics

A more open version on the horizontal axis that makes it possible to widen the pitch between fixtures and a new version defined as Narrow Asymmetric that is more comfortable and controlled.



The MINI version is available with a remote power

Supply for installation in extremely confined spaces and with an integrated driver to simplify installation and accommodate cables on building facades.



Off-centre rotation to zoom

The body of the fixture towards and away from the support surface. Fitted with a graduated scale for precise aiming.





Ponte di Rialto

Photographer
Ivan Rossi

Country
Venice - Italy

DART

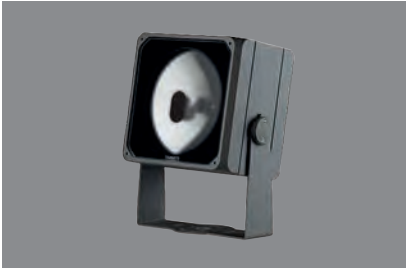

Maxi

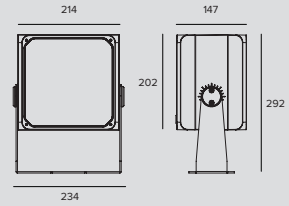

LED / 26W / INDIRECT / NSP



	3000K	H(m)	D(m)	Emax(lx)		
	Ra84		6°			
	Fixture Power	28W	1	0.11	152341	
	Source Flux	3273lm	2	0.22	38085	
	Fixture Flux	2170lm	3	0.33	16927	
	Efficacy	77lm/W	4	0.45	9521	
TS1008	Imax=46545cd/klm	Imax	152341cd	5	0.56	6094

Driver	Colour	3000K	4000K
EL.	●	1E3064EL	1E3070EL
1-10V	●	1E3064D	1E3070D
DALI	●	1E3064DA	1E3070DA

LED / 34W / INDIRECT / NSP



	3000K	H(m)	D(m)	Emax(lx)		
	Ra84		6°			
	Fixture Power	37W	1	0.11	196977	
	Source Flux	4232lm	2	0.22	49244	
	Fixture Flux	2806lm	3	0.33	21886	
	Efficacy	75lm/W	4	0.45	12311	
TS1008	Imax=46545cd/klm	Imax	196977cd	5	0.56	7879

Driver	Colour	3000K	4000K
EL.	●	1E3076EL	1E3082EL
1-10V	●	1E3076D	1E3082D
DALI	●	1E3076DA	1E3082DA

LED / 51W / HYBRID / SP

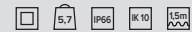

	3000K	H(m)	D(m)	Emax(lx)		
	Ra84		17°			
	Fixture Power	54W	1	0.30	34252	
	Source Flux	6780lm	2	0.60	8563	
	Fixture Flux	3634lm	3	0.89	3806	
	Efficacy	67lm/W	4	1.19	2141	
TS1009	Imax=5052cd/klm	Imax	34252cd	5	1.49	1370

Driver	Colour	3000K	4000K
EL.	●	1E3065EL	1E3071EL
1-10V	●	1E3065D	1E3071D
DALI	●	1E3065DA	1E3071DA

LED / 80W / HYBRID / SP



	3000K	H(m)	D(m)	Emax(lx)		
	Ra84		17°			
	Fixture Power	88W	1	0.30	43451	
	Source Flux	8601lm	2	0.60	10863	
	Fixture Flux	4609lm	3	0.89	4828	
	Efficacy	52lm/W	4	1.19	2716	
TS1009	Imax=5052cd/klm	Imax	43451cd	5	1.49	1738

Driver	Colour	3000K	4000K
EL.	●	1E3077EL	1E3083EL
1-10V	●	1E3077D	1E3083D
DALI	●	1E3077DA	1E3083DA

LED / 51W / HYBRID / FL



	3000K	H(m)	D(m)	Emax(lx)		
	Ra84		27°			
	Fixture Power	54W	1	0.47	19248	
	Source Flux	6780lm	2	0.94	4812	
	Fixture Flux	4081lm	3	1.42	2139	
	Efficacy	75lm/W	4	1.89	1203	
TS1010	Imax=2839cd/klm	Imax	19248cd	5	2.36	770

Driver	Colour	3000K	4000K
EL.	●	1E3066EL	1E3072EL
1-10V	●	1E3066D	1E3072D
DALI	●	1E3066DA	1E3072DA

LED / 80W / HYBRID / FL



	3000K	H(m)	D(m)	Emax(lx)		
	Ra84		27°			
	Fixture Power	88W	1	0.47	24418	
	Source Flux	8601lm	2	0.94	6104	
	Fixture Flux	5177lm	3	1.42	2713	
	Efficacy	59lm/W	4	1.89	1526	
	TS1010	Imax=2839cd/klm	Imax	24418cd	5	2.36

Driver	Colour	3000K	4000K
EL.	●	1E3078EL	1E3084EL
1-10V	●	1E3078D	1E3084D
DALI	●	1E3078DA	1E3084DA

LED / 51W / REFLECTOR / MWFL



	3000K	H(m)	D(m)	Emax(lx)		
	Ra84		38°			
	Fixture Power	54W	1	0.69	8952	
	Source Flux	6780lm	2	1.38	2238	
	Fixture Flux	5227lm	3	2.07	995	
	Efficacy	96lm/W	4	2.76	560	
	TS1011	Imax=1333cd/klm	Imax	9035cd	5	3.44

Driver	Colour	3000K	4000K
EL.	●	1E3067EL	1E3073EL
1-10V	●	1E3067D	1E3073D
DALI	●	1E3067DA	1E3073DA

LED / 80W / REFLECTOR / MWFL



	3000K	H(m)	D(m)	Emax(lx)		
	Ra84		38°			
	Fixture Power	88W	1	0.69	11357	
	Source Flux	8601lm	2	1.38	2839	
	Fixture Flux	6631lm	3	2.07	1262	
	Efficacy	75lm/W	4	2.76	710	
	TS1011	Imax=1333cd/klm	Imax	11461cd	5	3.44

Driver	Colour	3000K	4000K
EL.	●	1E3079EL	1E3085EL
1-10V	●	1E3079D	1E3085D
DALI	●	1E3079DA	1E3085DA

LED / 51W / REFLECTOR / WFL



	3000K	H(m)	D(m)	Emax(lx)		
	Ra84		52°			
	Fixture Power	54W	1	0.97	6549	
	Source Flux	6780lm	2	1.94	1637	
	Fixture Flux	5213lm	3	2.91	728	
	Efficacy	96lm/W	4	3.88	409	
	TS1012	Imax=966cd/klm	Imax	6549cd	5	4.85

Driver	Colour	3000K	4000K
EL.	●	1E3068EL	1E3074EL
1-10V	●	1E3068D	1E3074D
DALI	●	1E3068DA	1E3074DA

LED / 80W / REFLECTOR / WFL



	3000K	H(m)	D(m)	Emax(lx)		
	Ra84		52°			
	Fixture Power	88W	1	0.97	8308	
	Source Flux	8601lm	2	1.94	2077	
	Fixture Flux	6614lm	3	2.91	923	
	Efficacy	75lm/W	4	3.88	519	
	TS1012	Imax=966cd/klm	Imax	8308cd	5	4.85

Driver	Colour	3000K	4000K
EL.	●	1E3080EL	1E3086EL
1-10V	●	1E3080D	1E3086D
DALI	●	1E3080DA	1E3086DA

LED / 51W / ASYM



	3000K	H(m)	D1(m)	D2(m)	Emax(lx)		
	Ra84		89°	76°			
	Fixture Power	54W	1	1.96	3.41	2831	
	Source Flux	6780lm	2	3.93	6.83	708	
	Fixture Flux	5827lm	3	5.89	10.24	315	
	Efficacy	107lm/W	4	7.86	13.66	177	
	TS1013	Imax=895cd/klm	Imax	6070cd	5	9.82	17.07

Driver	Colour	3000K	4000K
EL.	●	1E3069EL	1E3075EL
1-10V	●	1E3069D	1E3075D
DALI	●	1E3069DA	1E3075DA

DART

LED / 80W / ASYM



		3000K		H(m)		D1(m)		D2(m)		Emax(lx)	
Ra84				89°		76°					
Fixture Power	88W	1	1.96	3.41	3591						
Source Flux	8601lm	2	3.93	6.83	898						
Fixture Flux	7391lm	3	5.89	10.24	399						
Efficacy	84lm/W	4	7.86	13.66	224						
TS1013	Imax=895cd/klm	Imax	7700cd	5	9.82	17.07	144				

Driver	Colour	3000K	4000K
EL	●	1E3081EL	1E3087EL
1-10V	●	1E3081D	1E3087D
DALI	●	1E3081DA	1E3087DA

Accessories

Filter



Filter	Ø	Code
Red	168	1E3088
Green	168	1E3089
Blue	168	1E3090
Yellow	168	1E3091
Magenta	168	1E3092

Chromatic filter.
Glass with dichroic treatment.
Non suitable for the asymmetric reflector nor for grazing lighting.
To be completed with a dedicated holder ring.

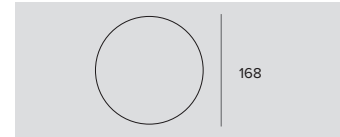

Code
1E3094

Blade of light filter.
PMMA holographic filter for a blade of light effect.
To be completed with a dedicated holder ring.
Diameter 168mm.

Grid

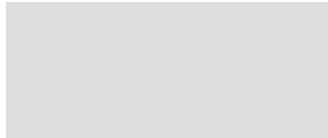

Code
1E3096

Anti-glare louver.
The central elements may be removed to obtain two different levels of glare control.
Powder coated stainless steel black + ferrite.

Screen

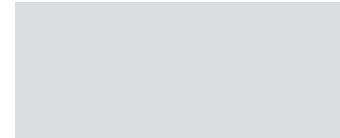

Code
1E3095

Asymmetric screen.
Powder coated stainless steel ferrite.

Mounting System

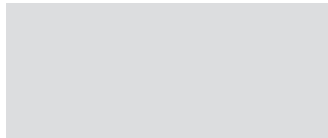

Code
1E3026

Plate for fixture rotation.
Powder coated stainless steel ferrite.

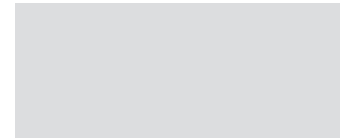

Ø	H	Code
96	182	1E3028
150	352	1E3188

Earthspike.
Powder coated stainless steel ferrite.

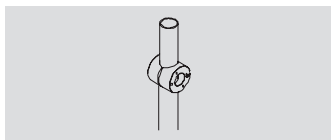

Code

1E2825

Pole bracket.
Anodised and powder coated aluminium.
Pole Ø 60mm (+/-2mm).

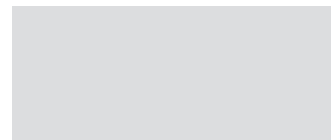

Code

1E3097

Pole multiple mounting system.
Powder coated stainless steel.
To be completed with 1E2825.
Max 4 projectors.

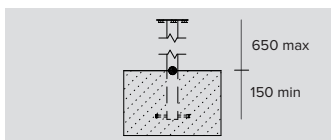

Code

1E3187

Pole with base.
Powder coated stainless steel.

Holder Ring

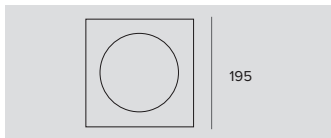

Code

1E3093

Holder ring.
Powder coated stainless steel.
Ax B 195x195mm.

Tool

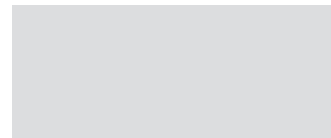

Code

1E3098

Laser pointing system.
Installed by friction on the projector's body.
Powder coated stainless steel.
Laser included.

Connector



Code

1E2769

Connectors kit for 5 pole coaxial connections.

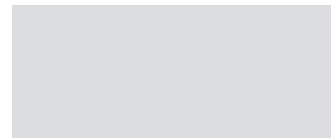

Code

1E2494

Non DALI looping connector.
1 IN - 3 OUT 4 poles max. wire section 2.5mm².
Cable diameter range from 8 to 12mm.
IP68

Control systems

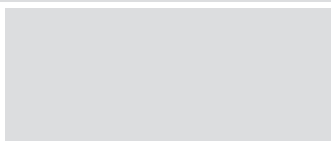

Code

1E3048

A IP67 Module for individual control of external devices equipped with DALI drivers.
The module needs to be positioned in order to receive radio signals.
The distance to the lighting fixtures can reach up to 50m.

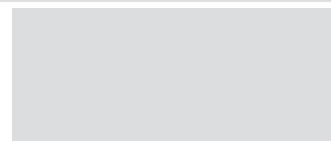

Code

1E3049

IP67 Extender for wireless control of DALI fixtures.
It generates a local DALI bus with the capacity to drive up to 64 fixtures.
Can control DALI fixtures in outdoor applications.

DART



Medium

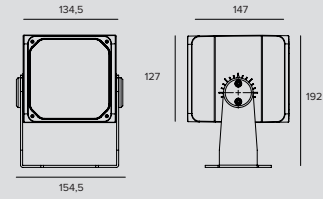

LED / 16W / LENS / NSP



		3000K	H(m)	D(m)	E _{max} (lx)	
Ra80				10°		
Fixture Power	19W	1	0.17	24179		
Source Flux	1332lm	2	0.34	6045		
Fixture Flux	1008lm	3	0.51	2687		
Efficacy	53lm/W	4	0.68	1511		
TS941	I _{max} =18153cd/klm	I _{max}	24179cd	5	0.86	967

Driver	Colour	3000K	4000K
EL.	●	1E2994EL	1E2995EL
1-10V	●	1E2994D	1E2995D
DALI	●	1E2994DA	1E2995DA

LED / 34W / HYBRID / SP



		3000K	H(m)	D(m)	E _{max} (lx)	
Ra84				13°		
Fixture Power	37W	1	0.23	38850		
Source Flux	4428lm	2	0.46	9712		
Fixture Flux	2738lm	3	0.69	4317		
Efficacy	74lm/W	4	0.92	2428		
TS942	I _{max} =8774cd/klm	I _{max}	38850cd	5	1.14	1554

Driver	Colour	3000K	4000K
EL.	●	1E2996EL	1E2997EL
1-10V	●	1E2996D	1E2997D
DALI	●	1E2996DA	1E2997DA

LED / 34W / HYBRID / FL



		3000K	H(m)	D(m)	E _{max} (lx)	
Ra84				33°		
Fixture Power	37W	1	0.58	9385		
Source Flux	4428lm	2	1.17	2346		
Fixture Flux	2570lm	3	1.75	1043		
Efficacy	69lm/W	4	2.33	587		
TS943	I _{max} =2119cd/klm	I _{max}	9385cd	5	2.92	375

Driver	Colour	3000K	4000K
EL.	●	1E2998EL	1E2999EL
1-10V	●	1E2998D	1E2999D
DALI	●	1E2998DA	1E2999DA

LED / 33W / REFLECTOR / MWFL



		3000K	H(m)	D(m)	E _{max} (lx)	
Ra84				48°		
Fixture Power	36W	1	0.89	5843		
Source Flux	4434lm	2	1.78	1461		
Fixture Flux	3703lm	3	2.68	649		
Efficacy	104lm/W	4	3.57	365		
TS944	I _{max} =1366cd/klm	I _{max}	6055cd	5	4.46	234

Driver	Colour	3000K	4000K
EL.	●	1E3000EL	1E3001EL
1-10V	●	1E3000D	1E3001D
DALI	●	1E3000DA	1E3001DA

LED / 33W / REFLECTOR / WFL



		3000K	H(m)	D(m)	E _{max} (lx)	
Ra84				62°		
Fixture Power	36W	1	1.20	4420		
Source Flux	4434lm	2	2.40	1105		
Fixture Flux	3725lm	3	3.60	491		
Efficacy	104lm/W	4	4.80	276		
TS945	I _{max} =997cd/klm	I _{max}	4420cd	5	5.99	177

Driver	Colour	3000K	4000K
EL.	●	1E3002EL	1E3003EL
1-10V	●	1E3002D	1E3003D
DALI	●	1E3002DA	1E3003DA

LED / 33W / ASYM



	3000K	H(m)	D1(m)	D2(m)	E _{max} (lx)		
Ra84			113°	91°			
Fixture Power	36W	1	3.02	4.08	1190		
Source Flux	4434lm	2	6.04	8.15	298		
Fixture Flux	3151lm	3	9.06	12.23	132		
Efficacy	88lm/W	4	12.08	16.30	74		
TS946	I _{max} =504cd/klm	I _{max}	2236cd	5	15.10	20.38	48

Driver	Colour	3000K	4000K
EL.	●	1E3004EL	1E3005EL
1-10V	●	1E3004D	1E3005D
DALI	●	1E3004DA	1E3005DA

LED / 33W / NARROW ASYM



	3000K	H(m)	D1(m)	D2(m)	E _{max} (lx)		
Ra84			41°	52°			
Fixture Power	36W	1	1.20	1.25	2760		
Source Flux	4514lm	2	2.41	2.49	690		
Fixture Flux	3497lm	3	3.61	3.74	307		
Efficacy	98lm/W	4	4.81	4.99	172		
TS1054	I _{max} =1098cd/klm	I _{max}	4956cd	5	6.02	6.24	110

Driver	Colour	3000K	4000K
EL.	●	1E3126EL	1E3127EL
1-10V	●	1E3126D	1E3127D
DALI	●	1E3126DA	1E3127DA

Accessories

Filter

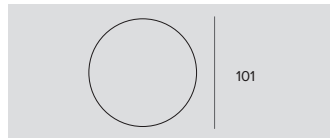

Filter	Ø	Code
Red	101	1E3017
Green	101	1E3018
Blue	101	1E3019
Yellow	101	1E3020
Magenta	101	1E3021

Chromatic filter.
Glass with dichroic treatment.
Non suitable for the asymmetric reflector nor for grazing lighting.
To be completed with a dedicated holder ring.

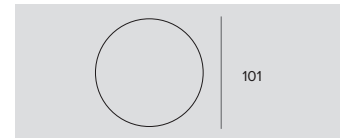

	Code
	1E3023

Blade of light filter.
PMMA holographic filter for a blade of light effect.
To be completed with a dedicated holder ring.
Diameter 101mm.

Grid

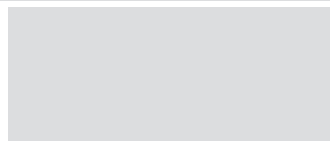

	Code
	1E3025

Anti-glare louver.
The central elements may be removed to obtain two different levels of glare control.
Powder coated stainless steel ferrite + nero.

Screen

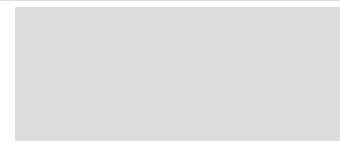

	Code
	1E3024

Asymmetric screen.
Powder coated stainless steel ferrite.

Mounting System

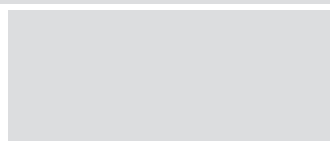

	Code
	1E3026

Plate for fixture rotation.
Powder coated stainless steel ferrite.

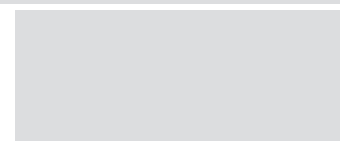

	Ø	H	Code
	96	182	1E3028

Earthspike.
Powder coated stainless steel ferrite.

DART

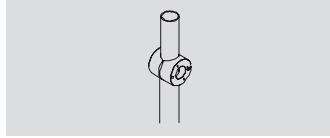

Code

1E2825

Pole bracket.
Anodised and powder coated aluminium.
Pole Ø 60mm (+/-2mm).

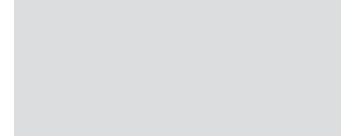

Code

1E3027

Pole multiple mounting system.
Powder coated stainless steel.
To be completed with 1E2825.
Max 4 projectors.

Holder Ring

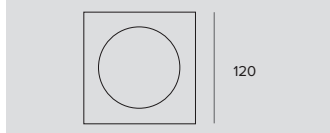

Code

1E3022

Holder ring.
Powder coated stainless steel.
AxB 120x120mm.

Tool

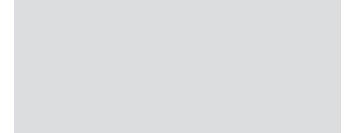

Code

1E3029

Laser pointing system.
Installed by friction on the projector's body.
Powder coated stainless steel.
Laser included.

Connector

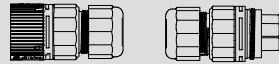

Code

1E2769

Connectors kit for 5 pole coaxial connections.

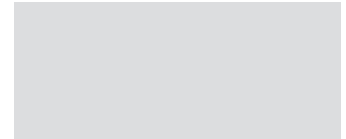

Code

1E2494

Non DALI looping connector.
1 IN - 3 OUT 4 poles max. wire section 2.5mm².
Cable diameter range from 8 to 12mm.
IP68

Control systems

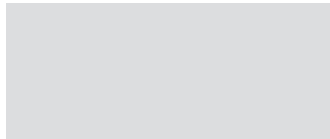

Code

1E3048

A IP67 Module for individual control of external devices equipped with DALI drivers.
The module needs to be positioned in order to receive radio signals.
The distance to the lighting fixtures can reach up to 50m.

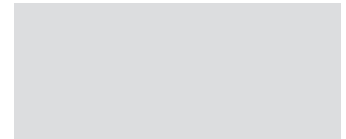

Code

1E3049

IP67 Extender for wireless control of DALI fixtures.
It generates a local DALI bus with the capacity to drive up to 64 fixtures.
Can control DALI fixtures in outdoor applications.



Small Driver integrato

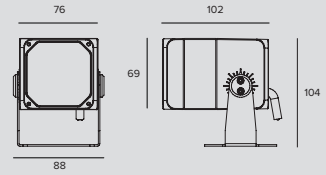

LED / 2,7W / LENS / NSP



	3000K	H(m)	D(m)	E _{max} (lx)		
	Ra80		9°			
Fixture Power	5W	1	0.15	4041		
Source Flux	200lm	2	0.30	1010		
Fixture Flux	151lm	3	0.46	449		
Efficacy	29lm/W	4	0.61	253		
TS937	I _{max} =20203cd/klm	I _{max}	4041cd	5	0.76	162

Driver	Colour	3000K	4000K
EL.	●	1E3056EL	1E3057EL

LED / 11W / LENS / SP



	3000K	H(m)	D(m)	E _{max} (lx)		
	Ra84		17°			
Fixture Power	15W	1	0.30	10469		
Source Flux	1786lm	2	0.61	2617		
Fixture Flux	1258lm	3	0.91	1163		
Efficacy	85lm/W	4	1.21	654		
TS938	I _{max} =5862cd/klm	I _{max}	10469cd	5	1.52	419

Driver	Colour	3000K	4000K
EL.	●	1E3058EL	1E3059EL

LED / 12W / LENS / FL



	3000K	H(m)	D(m)	E _{max} (lx)		
	Ra84		32°			
Fixture Power	14W	1	0.58	3645		
Source Flux	1821lm	2	1.15	911		
Fixture Flux	1231lm	3	1.73	405		
Efficacy	91lm/W	4	2.31	228		
TS939	I _{max} =2002cd/klm	I _{max}	3645cd	5	2.88	146

Driver	Colour	3000K	4000K
EL.	●	1E3060EL	1E3061EL

LED / 12W / REFLECTOR / MWFL



	3000K	H(m)	D(m)	E _{max} (lx)		
	Ra84		46°			
Fixture Power	14W	1	0.85	2586		
Source Flux	1821lm	2	1.70	647		
Fixture Flux	1435lm	3	2.54	287		
Efficacy	106lm/W	4	3.39	162		
TS940	I _{max} =1421cd/klm	I _{max}	2588cd	5	4.24	103

Driver	Colour	3000K	4000K
EL.	●	1E3062EL	1E3063EL

DART



Small Driver remoto

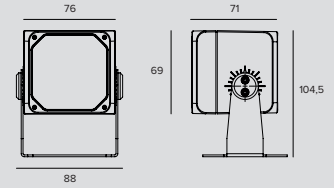

LED / 2,7W / LENS / NSP

	3000K	H(m)	D(m)	E _{max} (lx)		
Ra80			9°			
Fixture Power	5W	1	0.15	4041		
Source Flux	200lm	2	0.30	1010		
Fixture Flux	151lm	3	0.46	449		
Efficacy	29lm/W	4	0.61	253		
TS937	I _{max} =20203cd/klm	I _{max}	4041cd	5	0.76	162

Power supply	Colour	3000K	4000K
700/900mA	●	1E2986	1E2987

LED / 13W / LENS / SP

	3000K	H(m)	D(m)	E _{max} (lx)		
Ra84			17°			
Fixture Power	17W	1	0.30	10569		
Source Flux	1803lm	2	0.61	2642		
Fixture Flux	1270lm	3	0.91	1174		
Efficacy	75lm/W	4	1.21	661		
TS938	I _{max} =5862cd/klm	I _{max}	10569cd	5	1.52	423

Power supply	Colour	3000K	4000K
400mA	●	1E2988	1E2989

LED / 14W / LENS / FL

	3000K	H(m)	D(m)	E _{max} (lx)		
Ra84			32°			
Fixture Power	15W	1	0.58	4071		
Source Flux	2034lm	2	1.15	1018		
Fixture Flux	1375lm	3	1.73	452		
Efficacy	89lm/W	4	2.31	254		
TS939	I _{max} =2002cd/klm	I _{max}	4071cd	5	2.88	163

Power supply	Colour	3000K	4000K
400mA	●	1E2990	1E2991

LED / 14W / REFLECTOR / MWFL

	3000K	H(m)	D(m)	E _{max} (lx)		
Ra84			46°			
Fixture Power	15W	1	0.85	2889		
Source Flux	2034lm	2	1.70	722		
Fixture Flux	1603lm	3	2.54	321		
Efficacy	104lm/W	4	3.39	181		
TS940	I _{max} =1421cd/klm	I _{max}	2891cd	5	4.24	116

Power supply	Colour	3000K	4000K
400mA	●	1E2992	1E2993

Related codes

Power Supply

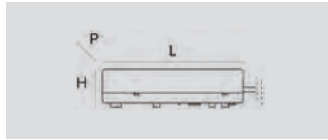

	Code
20W - 220-240Vac, 400mA - 118x22x52mm - IP20	1T4215EL
20W - 110-240Vac, 900mA - 118x22x52mm - IP20	1T5295EL
20W - 220-240Vac, 400mA - 150x40x148mm - IP68	1E3033EL
20W - 110-240Vac, 900mA - 150x40x148mm - IP68	1E3034EL

Electronic power supply
LxHxP

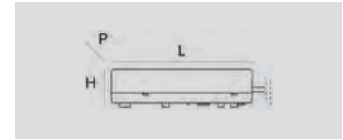

	Code
20W - 110-240Vac, 400mA - 118x22x52mm - IP20	1T4215D
20W - 110-240Vac, 900mA - 118x22x52mm - IP20	1T5295D
20W - 110-240Vac, 400mA - 150x40x148mm - IP68	1E3033D
20W - 110-240Vac, 900mA - 150x40x148mm - IP68	1E3034D

1-10V electronic power supply
LxHxP

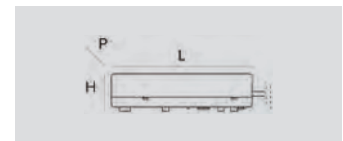

	Code
20W - 110-240Vac, 400mA - 118x22x52mm - IP20	1T4215DA
20W - 110-240Vac, 700mA - 118x22x52mm - IP20	1T5295DA
20W - 110-240Vac, 400mA - 150x40x148mm - IP68	1E3033DA
20W - 110-240Vac, 700mA - 150x40x148mm - IP68	1E3034DA

DALI electronic power supply
LxHxP

DART

Accessories

Filter

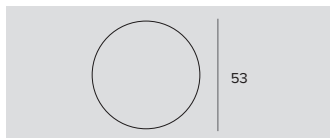

Filter	Ø	Code
Red	53	1E3006
Green	53	1E3007
Blue	53	1E3008
Yellow	53	1E3009
Magenta	53	1E3010

Chromatic filter.
Glass with dichroic treatment.
Non suitable for the asymmetric reflector nor for grazing lighting.
To be completed with a dedicated holder ring.

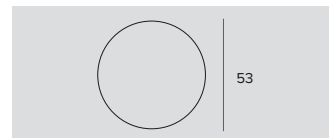

Ø	Code
53	1E3012

Blade of light filter.
PMMA holographic filter for a blade of light effect.
To be completed with a dedicated holder ring.

Grid

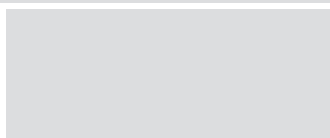

Code
1E3014

Anti-glare louver.
The central elements may be removed to obtain two different levels of glare control.
Powder coated stainless steel ferrite + black.

Screen

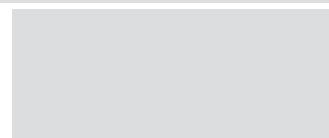

Code
1E3013

Asymmetric screen.
Powder coated stainless steel ferrite.

Mounting System

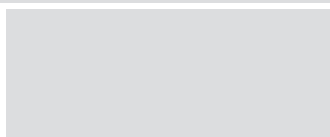

Code
1E3015

Plate for fixture rotation.
Powder coated stainless steel ferrite.

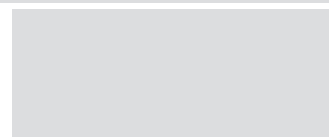

Code
1E3016

Earthspike.
Powder coated stainless steel ferrite.

Holder Ring

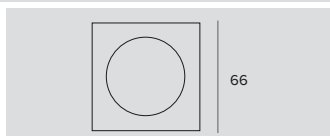

L	Code
66	1E3011

Holder ring.
Powder coated stainless steel.

Connector

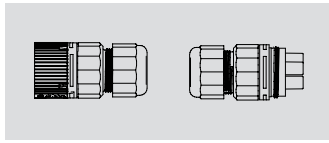

Code

1E2769

Connectors kit for 5 pole coaxial connections.



Code

1E2494

Non DALI looping connector.
1 IN - 3 OUT 4 poles max. wire section 2.5mm².
Cable diameter range from 8 to 12mm.
IP68

Control systems



Code

1E3048

A IP67 Module for individual control of external devices equipped with DALI drivers.
The module needs to be positioned in order to receive radio signals.
The distance to the lighting fixtures can reach up to 50m.



Code

1E3049

IP67 Extender for wireless control of DALI fixtures.
It generates a local DALI bus with the capacity to drive up to 64 fixtures.
Can control DALI fixtures in outdoor applications.

PYROS

GENERAL INFO

Professional projector.

PYROS

ø186mm

NANO PYROS

ø107mm

PICO PYROS

ø50mm

LED

Chip on board

LED Emitter for version PICO PYROS e RGBW

From 216lm to 9402lm

3000K – 4000K

Ra80 – Ra84

PRODUCT EFFICACY

Unitil 110lm/W

OPTICS

SP – FL – MWFL

POWER SUPPLY

Electronic

MATERIAL

Painted die-cast anodised aluminium body, brackets and joints.

A range that was designed for lighting building facades, accentuating trees and green elements and in all those contexts where precision must be combined with excellent performance.

The larger version is high performance making it suitable for lighting from long distances and large architectural structures. Where on the other hand it is required to light details the Nano and Pico versions provide optical solutions and different powers. PYROS shows the extent of its flexibility with its installation system that makes it possible to extend or contract it depending on requirements.

The Pyros and Nano Pyros versions are also available in RGBW and RGB versions.



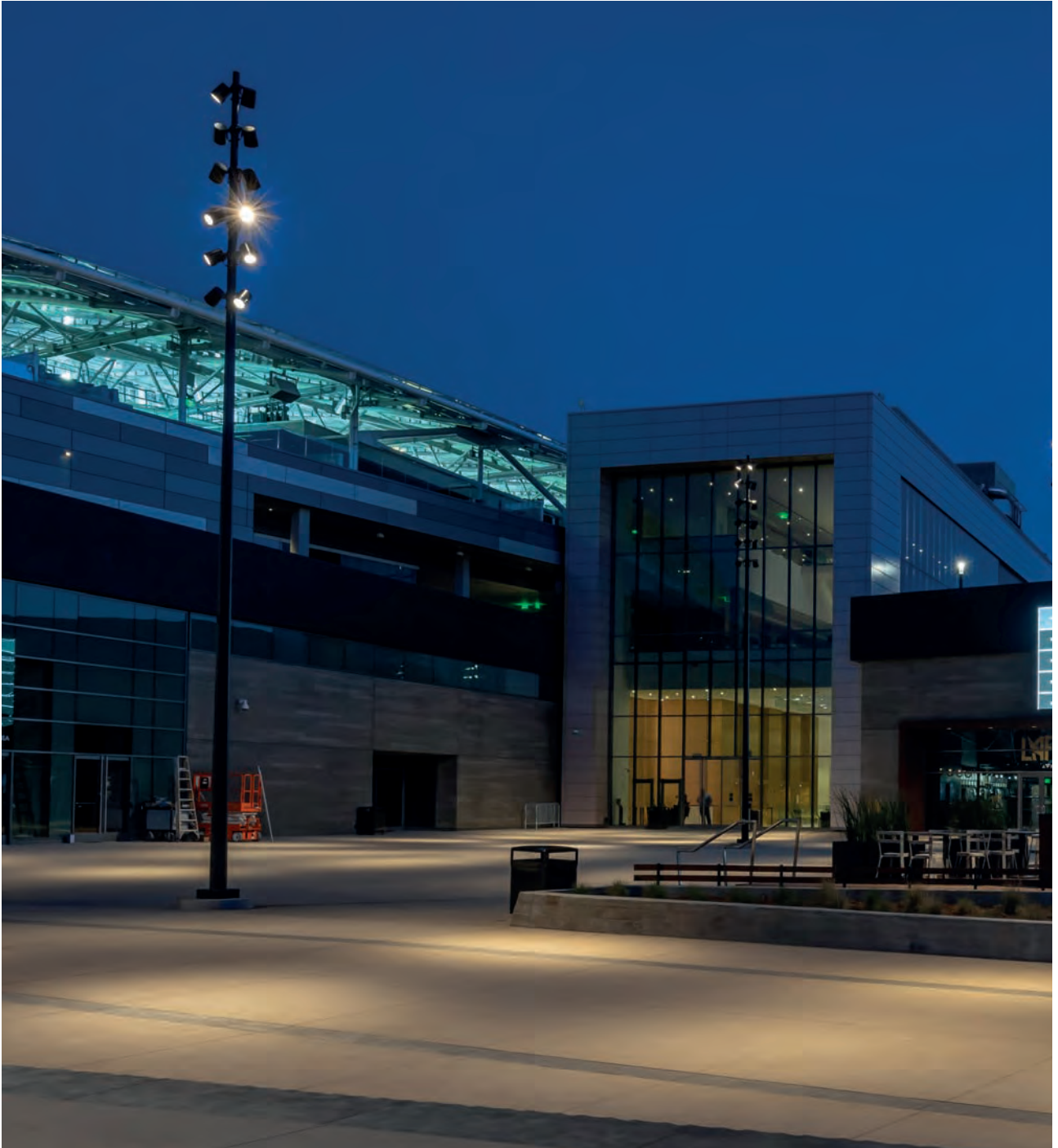

Banc of California Stadium

Architect
Gensler

Lighting Design
First Circle Design

Photographer
Henri Khodaverdi

Country
Los Angeles - USA

PYROS



L. 237mm

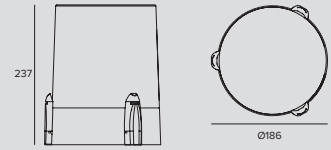

LED / 25W / SP

	3000K	H(m)	D(m)	E _{max} (lx)
Ra84			10°	
Fixture Power	28W	1	0.17	48565
Source Flux	3655lm	2	0.35	12141
Fixture Flux	2938lm	3	0.52	5396
Efficacy	105lm/W	4	0.69	3035
TS640	Imax=13287cd/klm	Imax	48565cd	5 0.87 1943

Driver	Colour	3000K	4000K
EL.	●	1E2779	1E2780

LED / 25W / FL

	3000K	H(m)	D(m)	E _{max} (lx)
Ra84			25°	
Fixture Power	28W	1	0.45	11885
Source Flux	3655lm	2	0.89	2971
Fixture Flux	2869lm	3	1.34	1321
Efficacy	102lm/W	4	1.79	743
TS641	Imax=3252cd/klm	Imax	11885cd	5 2.23 475

Driver	Colour	3000K	4000K
EL.	●	1E2781	1E2782

LED / 39W / SP

	3000K	H(m)	D(m)	E _{max} (lx)
Ra84			10°	
Fixture Power	42W	1	0.17	67087
Source Flux	5049lm	2	0.35	16772
Fixture Flux	4059lm	3	0.52	7454
Efficacy	98lm/W	4	0.69	4193
TS640	Imax=13287cd/klm	Imax	67087cd	5 0.87 2683

Driver	Colour	3000K	4000K
EL.	●	1E2783	1E2784

LED / 39W / FL

	3000K	H(m)	D(m)	E _{max} (lx)
Ra84			25°	
Fixture Power	42W	1	0.45	16417
Source Flux	5049lm	2	0.89	4104
Fixture Flux	3963lm	3	1.34	1824
Efficacy	95lm/W	4	1.79	1026
TS641	Imax=3252cd/klm	Imax	16417cd	5 2.23 657

Driver	Colour	3000K	4000K
EL.	●	1E2785	1E2786

LED / 50W / SP

	3000K	H(m)	D(m)	E _{max} (lx)
Ra84			10°	
Fixture Power	55W	1	0.17	91495
Source Flux	6672lm	2	0.35	22874
Fixture Flux	5364lm	3	0.52	10166
Efficacy	98lm/W	4	0.70	5718
TS972	Imax=13713cd/klm	Imax	91495cd	5 0.87 3660

Driver	Colour	3000K	4000K
EL.	●	1E2978	1E2979

LED / 50W / FL



		3000K	H(m)	D(m)	E _{max} (lx)	
		Ra84		24°		
Fixture Power	55W	1	0.43	22191		
Source Flux	6672lm	2	0.86	5548		
Fixture Flux	5237lm	3	1.28	2466		
Efficacy	95lm/W	4	1.71	1387		
TS973	I _{max} =3326cd/klm	I _{max}	22191cd	5	2.14	888



L. 307mm

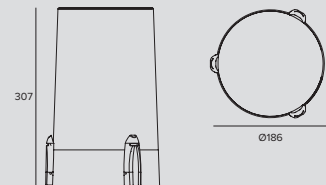

Driver	Colour	3000K	4000K
EL.	●	1E2980	1E2981

LED / 80W / SP



		3000K	H(m)	D(m)	E _{max} (lx)	
		Ra84		10°		
Fixture Power	88W	1	0.17	123310		
Source Flux	8992lm	2	0.35	30827		
Fixture Flux	7230lm	3	0.52	13701		
Efficacy	82lm/W	4	0.70	7707		
TS972	I _{max} =13713cd/klm	I _{max}	123310cd	5	0.87	4932

LED / 80W / FL

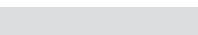

		3000K	H(m)	D(m)	E _{max} (lx)	
		Ra84		24°		
Fixture Power	88W	1	0.43	29908		
Source Flux	8992lm	2	0.86	7477		
Fixture Flux	7059lm	3	1.28	3323		
Efficacy	80lm/W	4	1.71	1869		
TS973	I _{max} =3326cd/klm	I _{max}	29908cd	5	2.14	1196

Driver	Colour	3000K	4000K
EL.	●	1E2982	1E2983

Driver	Colour	3000K	4000K
EL.	●	1E2984	1E2985



Note

All projector bodies must be completed with dedicated mounting brackets equipped with graduated metal rings on the bracket allowing 360° rotation on the horizontal axis and 180° on the vertical axis. Mechanical locking system to ensure aiming stability.

Related codes

Mounting System

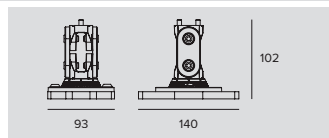

Kg	Colour	Code
0.6	●	1E2806

Die-cast aluminium bracket with double joint to allow 180° rotation on the vertical plane.
Graduated metal ring located at the base of the bracket to allow 360° rotation on the horizontal plane. Mechanical locking system to ensure aiming stability.
Short.

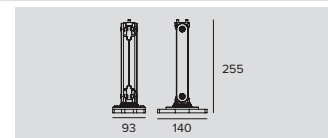

Kg	Colour	Code
1.3	●	1E2807

Die-cast aluminium bracket with double joint to allow 180° rotation on the vertical plane.
Graduated metal ring located at the base of the bracket to allow 360° rotation on the horizontal plane. Mechanical locking system to ensure aiming stability.
Long.

PYROS

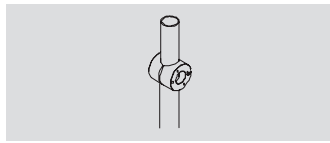

Code

1E2825

Pole bracket.
Anodised and powder coated aluminium.
Pole Ø 60mm (+/-2mm).

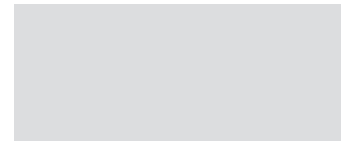

Code

1E2826

Pole head for pole with external diameter 60mm (+/-2mm) and internal diameter > 40mm.

Accessories

Filter



187

Filter	Ø	Code
Red	187	1E2816
Green	187	1E2817
Blue	187	1E2818
Yellow	187	1E2819

Chromatic filter. Complete with ring.



187

Ø Code

187 **1E2821**

"Blade of light" effect refractive filter.
The special linear incisions modify the light beam, enlarging it in a perpendicular direction to the incisions.
With very narrow beams it is possible to obtain precise "blades" of light for special effects.
Complete with ring.



187

Ø Code

187 **1E2822**

"Soft beam" effect refractive filter.
The special linear incisions reduce the variance between the primary and secondary light beam, making it more uniform.
Complete with ring.



187

Ø Code

187 **1E2820**

Frosted glass. Complete with ring.

Screen

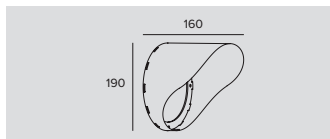

Code

1E2823

Adjustable stainless steel asymmetric screen with 8 positions and 2 mounting screws. Permits the shielding of the light beam with wide beam optics.

Ray Shade

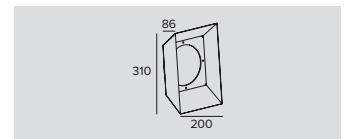

Code

1E2824

Stainless steel barn door with fixed flaps, adjustable to 4 positions with 2 mounting screws.

Connector

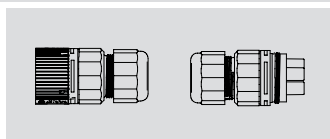

Code

1E2769

Connectors kit for 5 pole coaxial connections.

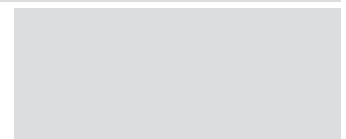

Code

1E2494

Non DALI looping connector.
1 IN - 3 OUT 4 poles max. wire section 2.5mm².
Cable diameter range from 8 to 12mm.
IP68



RGBW short arm

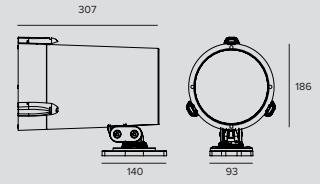

LED RGBW / 35W / SP



		H(m)	D(m)	E _{max} (lx)	
				19°	
Fixture Power	15W	1	0.34	735	
Source Flux	122lm	2	0.67	184	
Fixture Flux	122lm	3	1.01	82	
Efficacy	8lm/W	4	1.34	46	
TS1055	I _{max} =6025cd/klm	I _{max}	735cd	5	1.68 29

Driver	Colour	Code
EL. DMX	●	1E3124

LED RGBW / 35W / FL



		H(m)	D(m)	E _{max} (lx)	
				37°	
Fixture Power	15W	1	0.67	294	
Source Flux	120lm	2	1.34	74	
Fixture Flux	120lm	3	2.00	33	
Efficacy	8lm/W	4	2.67	18	
TS1056	I _{max} =2456cd/klm	I _{max}	295cd	5	3.34 12

Driver	Colour	Code
EL. DMX	●	1E3173



RGBW long arm

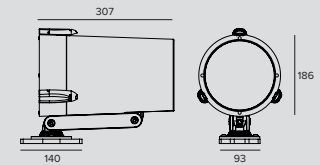

LED RGBW / 35W / SP



		H(m)	D(m)	E _{max} (lx)	
				19°	
Fixture Power	15W	1	0.34	735	
Source Flux	122lm	2	0.67	184	
Fixture Flux	122lm	3	1.01	82	
Efficacy	8lm/W	4	1.34	46	
TS1055	I _{max} =6025cd/klm	I _{max}	735cd	5	1.68 29

Driver	Colour	Code
EL. DMX	●	1E3125

LED RGBW / 35W / FL



		H(m)	D(m)	E _{max} (lx)	
				37°	
Fixture Power	15W	1	0.67	294	
Source Flux	120lm	2	1.34	74	
Fixture Flux	120lm	3	2.00	33	
Efficacy	8lm/W	4	2.67	18	
TS1056	I _{max} =2456cd/klm	I _{max}	295cd	5	3.34 12

Driver	Colour	Code
EL. DMX	●	1E3174

Note

Photometrics show the maximum emission values of fixtures.

Accessories

Screen

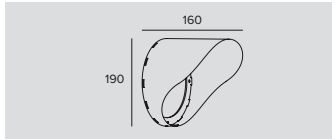

Code

1E2823

Adjustable stainless steel asymmetric screen with 8 positions and 2 mounting screws. Permits the shielding of the light beam with wide beam optics.

Ray Shade

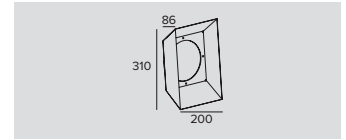

Code

1E2824

Stainless steel barn door with fixed flaps, adjustable to 4 positions with 2 mounting screws.

Mounting System

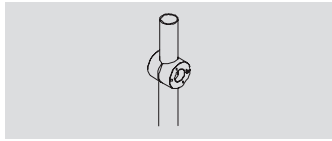

Code

1E2825

Pole bracket.
Anodised and powder coated aluminium.
Pole Ø 60mm (+/-2mm).

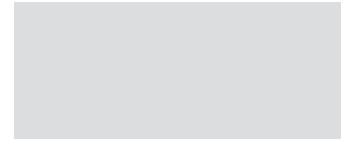

Code

1E2826

Pole head for pole with external diameter 60mm (+/-2mm) and internal diameter > 40mm.

Control systems

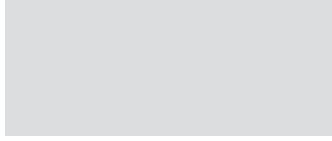

Code

1E2767

USB-RDM Programmer code.
DMX-RDM (Remote Device Management) address planner.
Used with the "RDM Targetti" software that can be downloaded for free from the Targetti website download section.
To be used with all RGBW products.

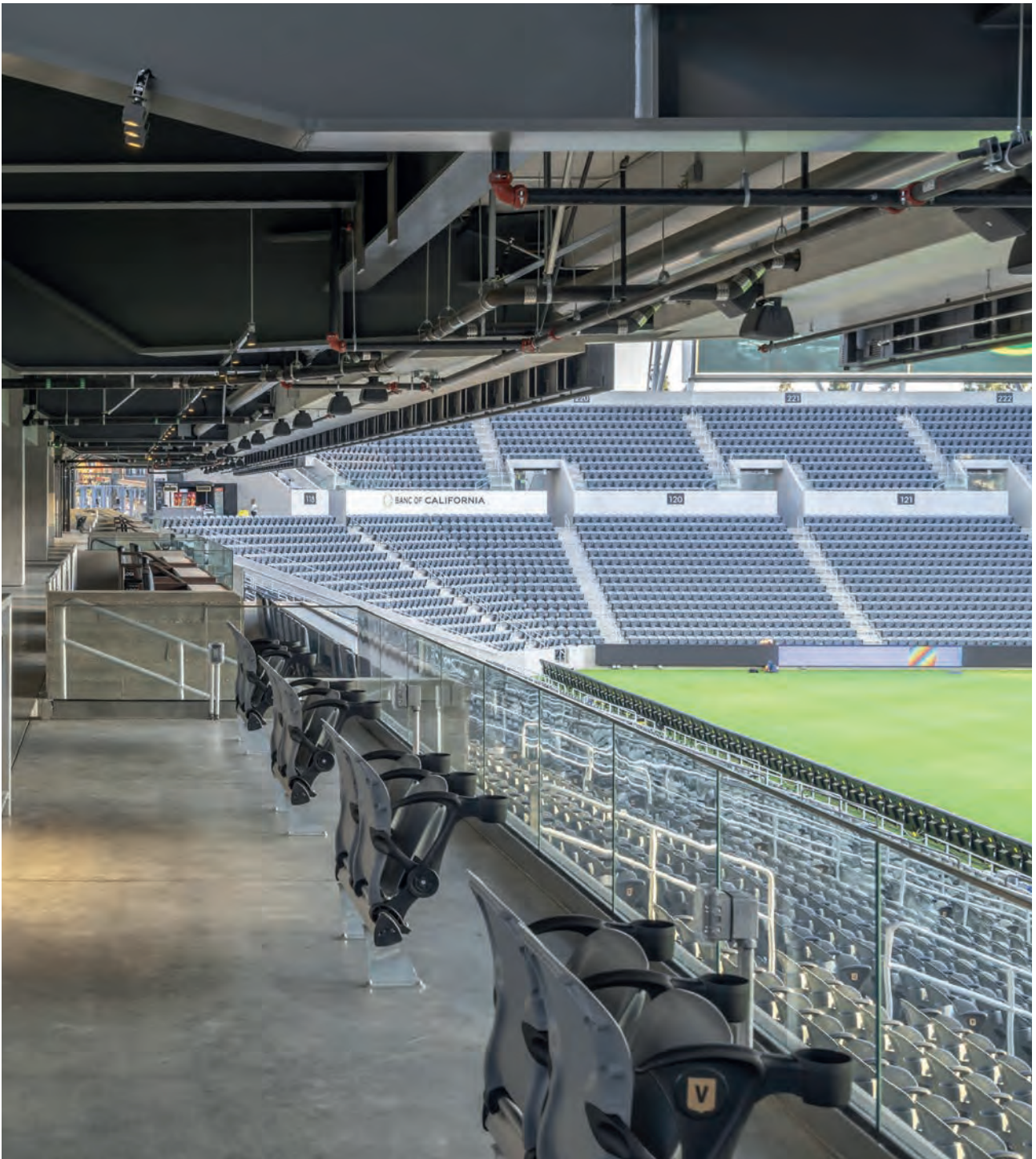

Banc of California Stadium

Architect
Gensler

Lighting Design
First Circle Design

Photographer
Henri Khodaverdi

Country
Los Angeles - USA

PYROS



NANO PYROS

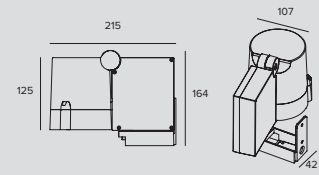

LED / 21W / HYBRID / SP



	3000K	H(m)	D(m)	E _{max} (lx)		
Ra84			13°			
Fixture Power	24W	1	0.23	25082		
Source Flux	2954lm	2	0.46	6271		
Fixture Flux	1768lm	3	0.69	2787		
Efficacy	73lm/W	4	0.92	1568		
TS649	I _{max} =8491cd/klm	I _{max}	25082cd	5	1.14	1003

Driver	Colour	3000K	4000K
EL.	●	1E2827	1E2828

LED / 21W / HYBRID / FL



	3000K	H(m)	D(m)	E _{max} (lx)		
Ra84			32°			
Fixture Power	24W	1	0.58	6061		
Source Flux	2954lm	2	1.17	1515		
Fixture Flux	1656lm	3	1.75	673		
Efficacy	69lm/W	4	2.33	379		
TS650	I _{max} =2052cd/klm	I _{max}	6061cd	5	2.91	242

Driver	Colour	3000K	4000K
EL.	●	1E2829	1E2830

LED / 21W / REFLECTOR / MWFL



	3000K	H(m)	D(m)	E _{max} (lx)		
Ra84			45°			
Fixture Power	24W	1	0.82	4830		
Source Flux	3153lm	2	1.64	1207		
Fixture Flux	2582lm	3	2.46	537		
Efficacy	107lm/W	4	3.28	302		
TS651	I _{max} =1559cd/klm	I _{max}	4917cd	5	4.10	193

Driver	Colour	3000K	4000K
EL.	●	1E2831	1E2832

Accessories

Filter



Kg	Filter	Ø	Code
0.4	Red	107	1E2849
0.4	Green	107	1E2850
0.4	Blue	107	1E2851
0.4	Yellow	107	1E2852

Chromatic filter. Complete with ring.

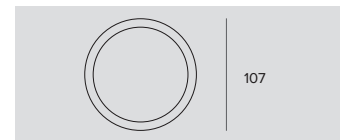

Kg	Ø	Code
0.2	107	1E2853

"Blade of light" effect refractive filter.

The special linear incisions modify the light beam, enlarging it in a perpendicular direction to the incisions.

With very narrow beams it is possible to obtain precise "blades" of light.

Complete with ring.

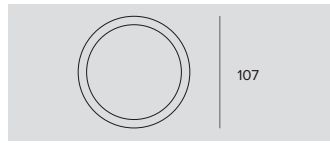

Kg	Ø	Code
0.2	107	1E2854

"Soft beam" effect refractive filter.
The special linear incisions reduce the variance between the primary and secondary light beam, making it more uniform.
Complete with ring.

Grid

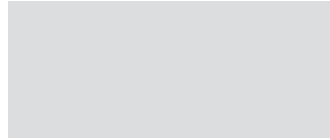

Code
1E2766

Anti-glare louver.
Black painted metal honeycomb structure.
Designed to be housed inside the fixture.

Screen

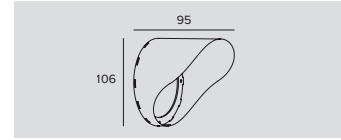

Code
1E2855

Adjustable stainless steel asymmetric screen with 8 positions and 2 mounting screws.
Permits the shielding of the light beam with wide beam optics.
0.7Kg.

Ray Shade

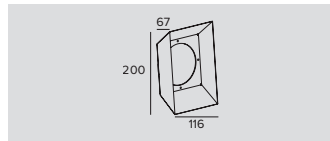

Code
1E2856

Stainless steel barn door with fixed flaps, adjustable to 4 positions with 2 mounting screws.
0.4Kg.

Mounting System

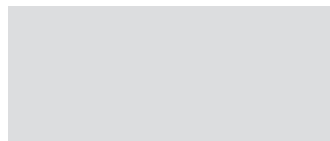

Kg	L	Code
0.5	200	1E2845
1.8	800	1E2846

Earthspike.

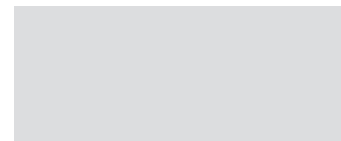

Kg	L	Code
0.7	232	1E2847
2	832	1E2848

Spike with base for surface installation.
1E2847 - Short peg with base for surface mounting.
1E2848 - Long peg with base for surface mounting.

Connector

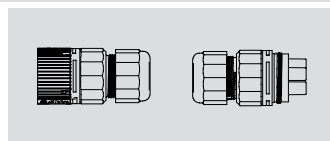

Code
1E2769

Connectors kit for 5 pole coaxial connections.

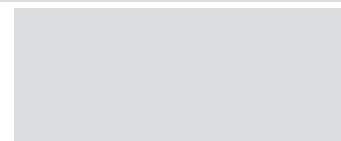

Code
1E2494

Non DALI looping connector.
1 IN - 3 OUT 4 poles max. wire section 2.5mm².
Cable diameter range from 8 to 12mm.
IP68

PYROS



NANO PYROS RGB

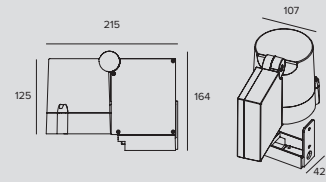

LED RGB / 20W / SP



		H(m)	D(m)	E _{max} (lx)		
				15°		
Fixture Power	25W	1	0.26	1396		
Source Flux	216lm	2	0.53	349		
Fixture Flux	173lm	3	0.79	155		
Efficacy	7lm/W	4	1.06	87		
EV308	I _{max} =6463cd/klm	I _{max}	1396cd	5	1.32	56

Driver	Colour	Code
EL. DMX	●	1E2833

LED RGB / 20W / FL



		H(m)	D(m)	E _{max} (lx)		
				24°		
Fixture Power	24W	1	0.42	800		
Source Flux	239lm	2	0.84	200		
Fixture Flux	187lm	3	1.26	89		
Efficacy	8lm/W	4	1.68	50		
EV174	I _{max} =3347cd/klm	I _{max}	800cd	5	2.10	32

Driver	Colour	Code
EL. DMX	●	1E2834

Note

Photometrics show the maximum emission values of fixtures.

Accessories

Grid

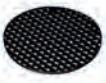

Code

1E2766

Anti-glare louver.
Black painted metal honeycomb structure.
Designed to be housed inside the fixture.

Screen

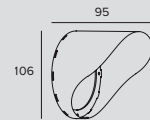

Code

1E2855

Adjustable stainless steel asymmetric screen with 8 positions and 2 mounting screws.
Permits the shielding of the light beam with wide beam optics.
0.7Kg.

Ray Shade

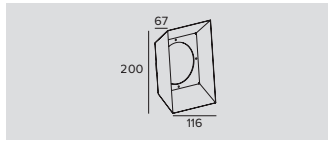

Code

1E2856

Stainless steel barn door with fixed flaps, adjustable to 4 positions with 2 mounting screws.
0.4Kg.

Mounting System

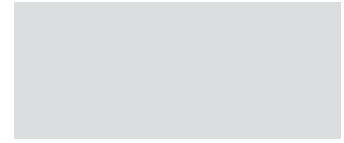
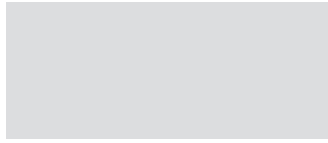

Kg	L	Code
0.5	200	1E2845
1.8	800	1E2846

Kg	L	Code
0.7	232	1E2847
2	832	1E2848

Earthspike.

Spike with base for surface installation.
1E2847 - Short peg with base for surface mounting.
1E2848 - Long peg with base for surface mounting.

Cable

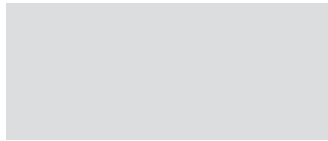

Code

1E1715

Multifunction cable for outdoor use (DMX + power supply).

Code

1T1932

Standard DMX cable (1 twisted pair + shield, 120Ohm).

Control systems

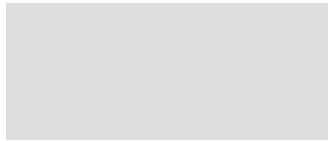

Code

1T1898

my-SCENARIO Show Store.
Digital devices designed to control dynamic lighting fixtures and programme dynamic light scenarios and sequences.
The system consists of intuitive software, compatible with Windows operating systems, able to control different hardware devices with the following functions: - record colour-changing scenarios set by the operator; - allow selection among the multiple scenarios already recorded; - transmit the control signals to the lighting system.
The software is interfaced to the PC through a USB port; the interface with lighting fixtures is featured through a DMX 512 output.
The software provides a graphic simulation of the operating keys of a lighting controller; the patching function allows the DMX control channels to be assigned to fixtures by using the internal library.
The Colour Manager function allows for quick and intuitive programming of a RGB light show, consisting of several steps with assigned duration and fading times.
The built-in calendar allows full time scheduling of show playback (month, day, hour, minutes, recurring events).
The programmed light shows can be transferred to different control interfaces.



Sage Hill High School

Lighting Design
First Circle Design

Photographer
©SAC Design

Country
Newport Coast - USA



PICO PYROS

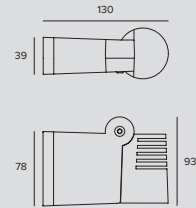

LED / 8W / SP								
	3000K	H(m)	D(m)	Emax(lx)	Driver	Colour	3000K	4000K
	Ra80		18°		EL.	●	1E2857	1E2859
	Fixture Power	11W	1	0.32	2253			
	Source Flux	501lm	2	0.65	563			
	Fixture Flux	408lm	3	0.97	250			
	Efficacy	39lm/W	4	1.29	141			
EV218	Imax=4497cd/klm	Imax	2253cd	5	1.62	90		

LED / 8W / FL								
	3000K	H(m)	D(m)	Emax(lx)	Driver	Colour	3000K	4000K
	Ra80		36°		EL.	●	1E2858	1E2860
	Fixture Power	11W	1	0.65	656			
	Source Flux	501lm	2	1.30	164			
	Fixture Flux	361lm	3	1.95	73			
	Efficacy	34lm/W	4	2.60	41			
EV216	Imax=1308cd/klm	Imax	656cd	5	3.25	26		

Accessories

Connector	
Code 1E2769	Code 1E2494
<p>Connectors kit for 5 pole coaxial connections. Remote mounting for the following products: Jupiter, Jupiter Mini, Saturn, Saturn Mini, and Led.Y.</p>	<p>Non DALI looping connector. 1 IN - 3 OUT 4 poles max. wire section 2.5mm². Cable diameter range from 8 to 12mm. IP68</p>

JUPITER

GENERAL INFO

Ultra compact adjustable projector
Ø38mm

LED

Chip on board
From 353lm to 1251lm
3000K – 4000K
Ra84

PRODUCT EFFICACY

Unitil 101lm/W

OPTICS

SP – FL – WFL

POWER SUPPLY

Electronic – DALI – 1-10V
Casambi control: the DALI version is fitted with special accessories.

MATERIAL

Anodised polished aluminium body. Aluminium front ring. Bevelled extra-clear front glass. Stainless steel bracket fixed to the body for adjustability.

Range of ultra compact projectors with lenticular type optic that makes it possible to obtain defined, precise beams.

It made entirely of “ferrite” colour painted anodised aluminium allows for vertical and horizontal rotation.

Can be installed in environments such as SPAs or around swimming pools, ensured by the 24V power supply system.

Also available inground versions in two different diameters ø50mm and ø80mm also in the new driver over solution.





Toyekunov Family Palace

Lighting designer
Tatyana
Shkolnikova

Photographer
Ilya Kouzov

Country
Moscow - Russia

01 JUPITER



JUPITER

JUPITER is the most simple and compact version in the family, with a fixed, lenticular-type optic system for precise and defined beams. It is entirely made of anodized aluminium painted ferrite complete with a steel bracket that allows it to be adjusted in respect to both the vertical and horizontal plane.

02 JUPITER PRO



JUPITER PRO

JUPITER PRO is the most professional projector of the JUPITER range and it is available in two different diameters Ø40 and Ø50 with fixed or multiple optics.

03



Variable and flexible mounting

To ensure “universal” mounting, JUPITER PRO can be installed with any support equipped with a G ½” male shank slot. There are two different mounting systems available as an accessory: a stake for in-ground mounting, and a plate for wall or surface mounting.



Multi-optic versions

One of the primary features of JUPITER is the ability to change the beam angle of the Multi-optic version. Without changing the IP rating, the holographic filter can be changed inside the optical compartment to obtain different beam angles. The product comes with additional holographic filters so they can be changed based on the project needs.



Three elements in a single projector

JUPITER is made up of three elements:

- the base that can be attached to the floor or wall and then completed with the actual projector body;
- The central body, which is the heart of the system and physically isolated from the other elements with resin coating;
- The optical compartment that allows to vary the beam angle by replacing the different holographic filters.



PRO

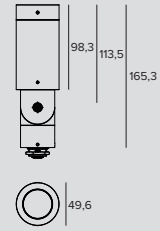

LED / 5,7W / LENS / NSP ⊕ 0.62 IP66 15m

	3000K	H(m)	D(m)	E _{max} (lx)
Ra84			8°	
Fixture Power	9W	1	0.15	15123
Source Flux	625lm	2	0.30	3781
Fixture Flux	473lm	3	0.44	1680
Efficacy	54lm/W	4	0.59	945
TS1186	I _{max} =24196cd/klm	I _{max}	15123cd	5 0.74 605

Power supply	Colour	2700K	3000K	3500K
24Vdc		1E3773	1E3774	1E3775
24Vdc		1E3776	1E3777	1E3778

LED / 10,35W / MULTI-OPTIC LENS / SP, NFL, FL, MWFL ⊕ 0.62 IP66 15m

	3000K	H(m)	D(m)	E _{max} (lx)
Ra84			15°	
Fixture Power	12W	1	0.27	8372
Source Flux	1148lm	2	0.54	2093
Fixture Flux	858lm	3	0.81	930
Efficacy	72lm/W	4	1.08	523
TS1187	I _{max} =7292cd/klm	I _{max}	8372cd	5 1.35 335

Power supply	Colour	2700K	3000K	3500K
24Vdc		1E3779	1E3780	1E3781
24Vdc		1E3782	1E3783	1E3784

	3000K	H(m)	D(m)	E _{max} (lx)
Ra84			24°	
Fixture Power	12W	1	0.43	3309
Source Flux	1148lm	2	0.85	827
Fixture Flux	812lm	3	1.28	368
Efficacy	68lm/W	4	1.71	207
TS1188	I _{max} =2883cd/klm	I _{max}	3309cd	5 2.14 132

	3000K	H(m)	D(m)	E _{max} (lx)
Ra84			44°	
Fixture Power	12W	1	0.82	1158
Source Flux	1148lm	2	1.63	290
Fixture Flux	801lm	3	2.45	129
Efficacy	67lm/W	4	3.27	72
TS1190	I _{max} =1009cd/klm	I _{max}	1158cd	5 4.08 46

	3000K	H(m)	D(m)	E _{max} (lx)
Ra84			31°	
Fixture Power	12W	1	0.55	2200
Source Flux	1148lm	2	1.09	550
Fixture Flux	819lm	3	1.64	244
Efficacy	68lm/W	4	2.18	137
TS1189	I _{max} =1916cd/klm	I _{max}	2200cd	5 2.73 88

Related codes

Mounting System

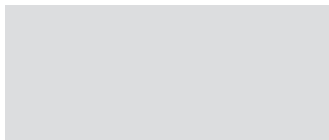

Colour	Code
	1E3785
	1E3803

Earthspike.
Powder coated stainless steel.

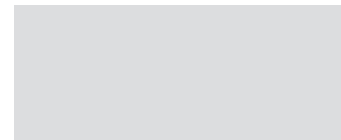

Colour	Code
	1E3786
	1E3804

Plate for fixture rotation.
Powder coated stainless steel.

JUPITER

Related codes

Power Supply

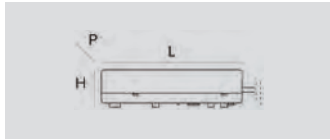

	Code
10W - 220-240Vac, 24Vdc - 79x24,5x38mm - IP67	1E3179
50W - 220-240Vac, 24Vdc - 185x22x63,5mm - IP20	1T3726
75W - 220-240Vac, 24Vdc - 130x32x80mm - IP67	1T3586
100W - 220-240Vac, 24Vdc - 230x87x43mm - IP67	1T3587
200W - 220-240Vac, 24Vdc - 238x42x67mm - IP67	1T3588

Electronic power supply
LxHxP



	Code
Electronic power supply max 20W, Ø98 h78, 220/240V-AC, 24V-DC, IP68.	1E0993

Accessories

Filter



Filter	Ø	Code
Red	50	1E3798
Green	50	1E3799
Blue	50	1E3800
Yellow	50	1E3801
Magenta	50	1E3802

Chromatic filter.
Glass with dichroic treatment.



	Code
Blade of light filter. PMMA holographic filter for a blade of light effect. Diameter 50mm.	1E3790

Grid



	Code
Anti-glare louver. Black painted metal honeycomb structure. Ready to be housed inside the optical compartment. Diameter 50mm.	1E3792

Screen



	Colour	Code
Asymmetric screen. Powder coated stainless steel. Diameter 50mm.	●	1E3788
	●	1E3806

Connector

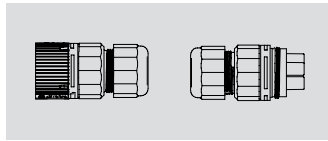

Code

1E2769

Connectors kit for 5 pole coaxial connections.



Code

1E2494

Non DALI looping connector.
1 IN - 3 OUT 4 poles max. wire section 2.5mm².
Cable diameter range from 8 to 12mm.
IP68

Control systems

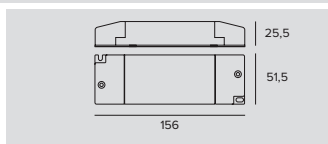

Code

1T6581

DALI/1-10V dimmer 12/24V.



Code

1E3048

A IP67 Module for individual control of external devices equipped with DALI drivers.
The module needs to be positioned in order to receive radio signals.
The distance to the lighting fixtures can reach up to 50m.



Code

1E3049

IP67 Extender for wireless control of DALI fixtures.
It generates a local DALI bus with the capacity to drive up to 64 fixtures.
Can control DALI fixtures in outdoor applications.

JUPITER

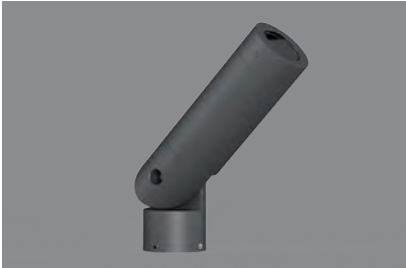

PRO Small

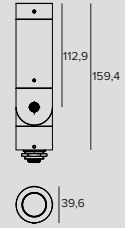

LED / 5,7W / LENS MULTIOPTIC / SP, FL, MWFL



3000K	H(m)	D(m)	Emax(lx)
Ra84		11°	
Fixture Power	8W	1	0.19 8774
Source Flux	605lm	2	0.38 2194
Fixture Flux	442lm	3	0.57 975
Efficacy	57lm/W	4	0.75 548
TS1183	Imax=14505cd/klm	Imax	8774cd 5 0.94 351

Power supply	Colour	2700K	3000K	3500K
24Vdc		1E3767	1E3768	1E3769
24Vdc		1E3770	1E3771	1E3772

3000K	H(m)	D(m)	Emax(lx)
Ra84		20°	
Fixture Power	8W	1	0.36 2174
Source Flux	605lm	2	0.72 543
Fixture Flux	387lm	3	1.08 242
Efficacy	50lm/W	4	1.44 136
TS1184	Imax=3593cd/klm	Imax	2174cd 5 1.80 87

3000K	H(m)	D(m)	Emax(lx)
Ra84		37°	
Fixture Power	8W	1	0.68 714
Source Flux	605lm	2	1.36 178
Fixture Flux	349lm	3	2.04 79
Efficacy	45lm/W	4	2.71 45
TS1185	Imax=1180cd/klm	Imax	714cd 5 3.39 29

Related codes

Mounting System

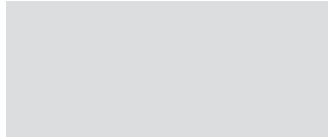

Colour	Code
	1E3785
	1E3803

Earthspike.
Powder coated stainless steel.

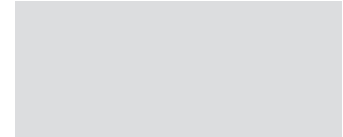

Colour	Code
	1E3786
	1E3804

Plate for fixture rotation.
Powder coated stainless steel.

Power Supply

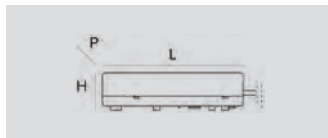

	Code
10W - 220-240Vac, 24Vdc - 79x24,5x38mm - IP67	1E3179
50W - 220-240Vac, 24Vdc - 185x22x63,5mm - IP20	1T3726
75W - 220-240Vac, 24Vdc - 130x32x80mm - IP67	1T3586
100W - 220-240Vac, 24Vdc - 230x87x43mm - IP67	1T3587
200W - 220-240Vac, 24Vdc - 238x42x67mm - IP67	1T3588

Electronic power supply
LxHxP

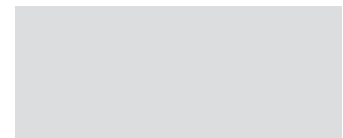

	Code
	1E0993

Electronic power supply max 20W, Ø98 h78, 220/240V-AC, 24V-DC, IP68.

Accessories

Filter

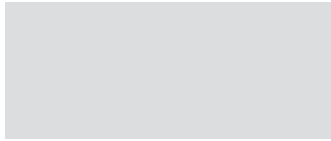

Filter	Ø	Code
Red	40	1E3793
Green	40	1E3794
Blue	40	1E3795
Yellow	40	1E3796
Magenta	40	1E3797

Chromatic filter.
Glass with dichroic treatment.

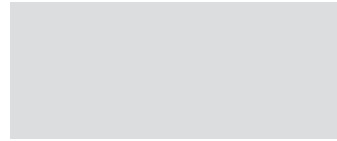

Code
1E3789

Blade of light filter.
PMMA holographic filter for a blade of light effect.
Diameter 40mm.

Grid

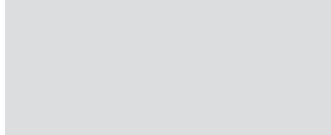



Code
1E3791

Anti-glare louver.
Black painted metal honeycomb structure.
Ready to be housed inside the optical compartment.
Diameter 40mm.

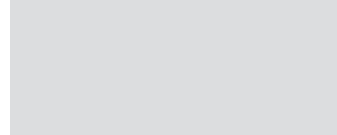
Screen



Colour	Code
	1E3787
	1E3805

Asymmetrical screen.
Powder coated stainless steel.
Diameter 40mm.

Connector

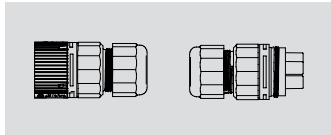
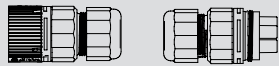

Code
1E2769

Connectors kit for 5 pole coaxial connections.
Remote mounting.

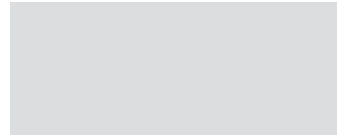

Code
1E2494

Non DALI looping connector.
1 IN - 3 OUT 4 poles max. wire section 2.5mm².
Cable diameter range from 8 to 12mm.
IP68

JUPITER

Control systems

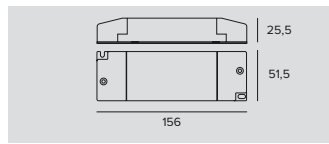

Code

1T6581

DALI/1-10V dimmer 12/24V.



Code

1E3048

A IP67 Module for individual control of external devices equipped with DALI drivers. The module needs to be positioned in order to receive radio signals. The distance to the lighting fixtures can reach up to 50m.



Code

1E3049

IP67 Extender for wireless control of DALI fixtures. It generates a local DALI bus with the capacity to drive up to 64 fixtures. Can control DALI fixtures in outdoor applications.



Mini Projector

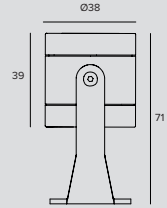

LED / 3W / SP



	3000K	H(m)	D(m)	E _{max} (lx)
	Ra84		17°	
Fixture Power	4W	1	0.31	2037
Source Flux	353lm	2	0.61	509
Fixture Flux	295lm	3	0.92	226
Efficacy	74lm/W	4	1.23	127
TS1048	I _{max} =5771cd/klm	I _{max}	2037cd	81

Power supply	Colour	3000K	4000K
24Vdc	●	1E3167	1E3168

LED / 3W / FL



	3000K	H(m)	D(m)	E _{max} (lx)
	Ra84		30°	
Fixture Power	4W	1	0.54	1062
Source Flux	353lm	2	1.09	266
Fixture Flux	289lm	3	1.63	118
Efficacy	72lm/W	4	2.17	66
TS1049	I _{max} =3009cd/klm	I _{max}	1062cd	42

Power supply	Colour	3000K	4000K
24Vdc	●	1E3169	1E3170

LED / 3W / WFL



	3000K	H(m)	D(m)	E _{max} (lx)
	Ra84		60°	
Fixture Power	4W	1	1.16	367
Source Flux	353lm	2	2.32	92
Fixture Flux	302lm	3	3.47	41
Efficacy	75lm/W	4	4.63	23
TS1050	I _{max} =1041cd/klm	I _{max}	367cd	15

Power supply	Colour	3000K	4000K
24Vdc	●	1E3171	1E3172

Related codes

Power Supply

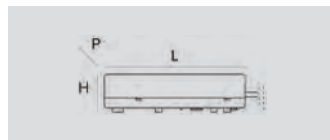

	Code
10W - 220-240Vac, 24Vdc - 79x24,5x38mm - IP67	1E3179
50W - 220-240Vac, 24Vdc - 185x22x63,5mm - IP20	1T3726
75W - 220-240Vac, 24Vdc - 130x32x80mm - IP67	1T3586
100W - 220-240Vac, 24Vdc - 230x87x43mm - IP67	1T3587
200W - 220-240Vac, 24Vdc - 238x42x67mm - IP67	1T3588

	Code
Electronic power supply max 20W, Ø98 h78, 220/240V-AC, 24V-DC, IP68.	1E0993

Electronic power supply
LxHxP

JUPITER

Accessories

Mounting System



L	Code
110	1E0995FE

Ferrite painted peg for ground anchorage.

Connector

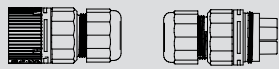

Code
1E2769

Connectors kit for 5 pole coaxial connections.
Remote mounting.



Code
1E2494

Non DALI looping connector.
1 IN - 3 OUT 4 poles max. wire section 2.5mm².
Cable diameter range from 8 to 12mm.
IP68

Control systems

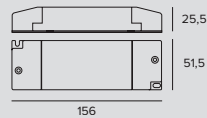

Code
1T6581

DALI/1-10V dimmer 12/24V.



Code
1E3048

A IP67 Module for individual control of external devices equipped with DALI drivers.
The module needs to be positioned in order to receive radio signals.
The distance to the lighting fixtures can reach up to 50m.



Code
1E3049

IP67 Extender for wireless control of DALI fixtures.
It generates a local DALI bus with the capacity to drive up to 64 fixtures.
Can control DALI fixtures in outdoor applications.



Toyekunov Family Palace

Lighting designer
Tatyana
Shkolnikova

Photographer
Ilya Kouzov

Country
Moscow - Russia

LED.Y

GENERAL INFO

Adjustable on bracket projector
ø50mm

LED

Mono-led
LED emitter
3000K – 6000K
From 99lm to 143lm
Ra80
RGB: RGB LED Multichip
From 40lm to 48lm

PRODUCT EFFICACY

Until 47lm/W

OPTICS

Versions Mono-led
SP - FL

POWER SUPPLY

Electronic

MATERIAL

Anodised aluminium body and bracket.

A series of miniature fixtures available in recessed or projector versions with monochromatic LED and RGB technology.

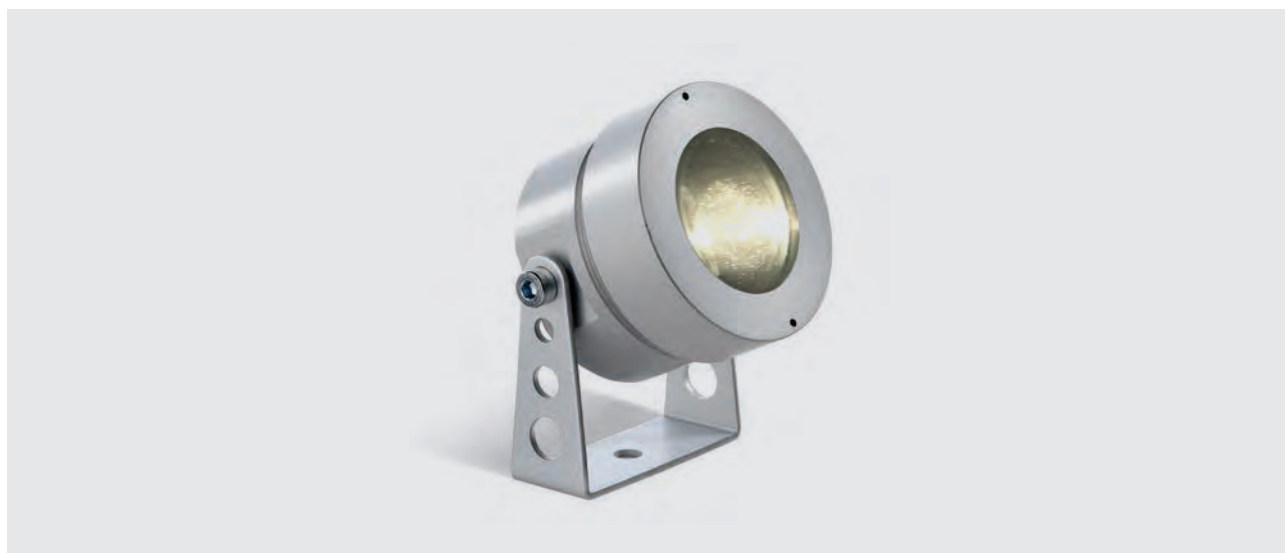

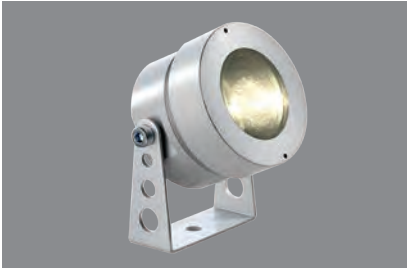

Projector

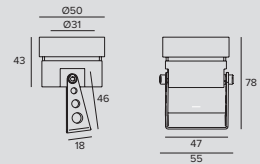

LED / 2W / SP								
	3000K	H(m)	D(m)	Emax(lx)	Power supply	Colour	3000K	6000K
	Ra80		9°		700mA	●	1E2371	1E2372
	Fixture Power	3W	1	0.16	2012			
	Source Flux	117lm	2	0.32	503			
	Fixture Flux	116lm	3	0.48	224			
	Efficacy	39lm/W	4	0.64	126			
T5670	Imax=17195cd/klm	Imax	2012cd	5	0.80	80		

LED / 2W / FL								
	3000K	H(m)	D(m)	Emax(lx)	Power supply	Colour	3000K	6000K
	Ra80		34°		700mA	●	1E2373	1E2374
	Fixture Power	3W	1	0.60	223			
	Source Flux	99lm	2	1.21	56			
	Fixture Flux	99lm	3	1.81	25			
	Efficacy	33lm/W	4	2.42	14			
T5671	Imax=2253cd/klm	Imax	223cd	5	3.02	9		

Related codes

Accessories

Power Supply

Code	
1E1385	

Electronic power supply 17W, Ø105 h74, 220-240V, 700mA - 12W, Ø105 h74, 110-120V, 700mA.
For Led.Y Monoled: it can drive up to 6 LED.Y fixtures simultaneously. Connection in series.

Mounting System

L	Code
110	1E0995

Peg for ground anchorage.
Stainless steel.

Connector

Code	
1E2769	

Connectors kit for 5 pole coaxial connections.
Remote mounting.

Code	
1E2494	

Non DALI looping connector.
1IN - 3 OUT 4 poles max. wire section 2.5mm².
Cable diameter range from 8 to 12mm.
IP68

LED.Y

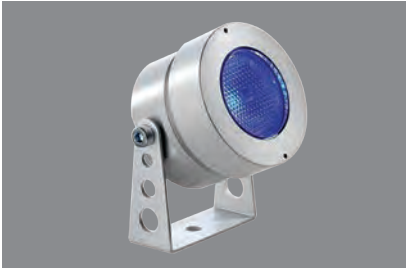

Projector RGB

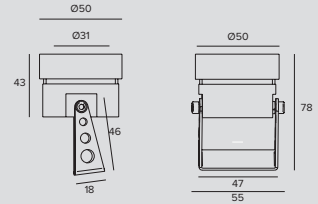

LED RGB / 3,5W / SP

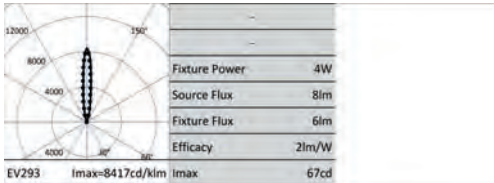

Power supply	Colour	RGB
3x350mA	●	1E1855

Note

Photometrics show the maximum emission values of fixtures.

LED RGB / 3,5W / FL

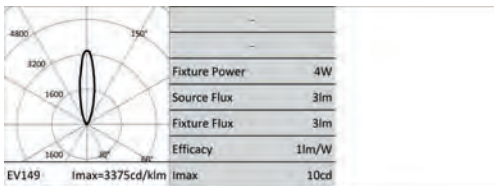

Power supply	Colour	RGB
3x350mA	●	1E1410

Note

Photometrics show the maximum emission values of fixtures.

Related codes

Control systems



Code

1E1401

SECS 75.

Power supply and Control System SECS Scene Effect Control System.

SECS 75 drivers combine the following 3 functions in a single unit.: power supply to RGB LED devices, playback of pre-set colour sequences and a DMX interface for external control devices.

The SECS "Easy-Run-Menu" function is able to playback colour-changing light scenarios that are pre-stored into the driver without the use of an external driver: - 8 static colour scenarios; - 8 dynamic colour sequences; - 5 different playback speed values; - Start/Stop the selected scenario using a remote switch.

SECS 75 drivers can also be controlled through DMX 512; in this case: - DMX address (from 1 to 511) can be configured by using dip-switches; - 3 channel mode: all R-G-B outputs are controlled simultaneously by 3 DMX channels only; - 6 channel mode: the outputs are divided into 2 R-G-B groups, each one controlled by 3 different DMX channels; - DMX line termination: SECS drivers contain a 120Ohm resistance which can be activated using a dip-switch; - DMX output is available for connection to other DMX devices.

75W output IP67



Code

1T1827

SECS 75.

Power supply and Control System SECS Scene Effect Control System.

SECS 75 drivers combine the following 3 functions in a single unit.: power supply to RGB LED devices, playback of pre-set colour sequences and a DMX interface for external control devices.

The SECS "Easy-Run-Menu" function is able to playback colour-changing light scenarios that are pre-stored into the driver without the use of an external driver: - 8 static colour scenarios; - 8 dynamic colour sequences; - 5 different playback speed values; - Start/Stop the selected scenario using a remote switch.

SECS 75 drivers can also be controlled through DMX 512; in this case: - DMX address (from 1 to 511) can be configured by using dip-switches; - 3 channel mode: all R-G-B outputs are controlled simultaneously by 3 DMX channels only; - 6 channel mode: the outputs are divided into 2 R-G-B groups, each one controlled by 3 different DMX channels; - DMX line termination: SECS drivers contain a 120Ohm resistance which can be activated using a dip-switch; - DMX output is available for connection to other DMX devices.

75W output IP20

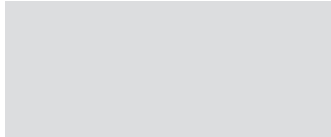

Code

1T2245

SECS 36.

Power supply and Control System SECS Scene Effect Control System.

SECS 36 drivers combine the following 3 functions in a single unit: power supply to RGB LED devices, playback of pre-set colour sequences and a DMX interface for external control devices.

The SECS "Easy-Run-Menu" function is able to playback colour-changing light scenarios that are pre-stored into the driver without the use of an external driver: - 8 static colour scenarios; - 8 dynamic colour sequences; - 5 different playback speed values; - Start/Stop the selected scenario using a remote switch.

SECS 75 drivers can also be controlled through DMX 512; in this case: - DMX address (from 1 to 511) can be configured by using dip-switches; - 3 channel mode: all R-G-B outputs are controlled simultaneously by 3 DMX channels only; - 6 channel mode: the outputs are divided into 2 R-G-B groups, each one controlled by 3 different DMX channels; - DMX line termination: SECS drivers contain a 120Ohm resistance which can be activated using a dip-switch; - DMX output is available for connection to other DMX devices.

35W output IP20

Accessories

Mounting System

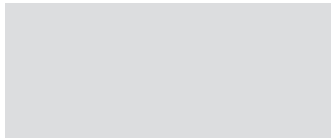

L

Code

110

1E0995

Peg for ground anchorage.
Stainless steel.

Cable

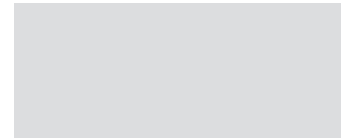

Code

1E1713

6-pole cable for driver output connection to Constant Current LED sources.

Control systems

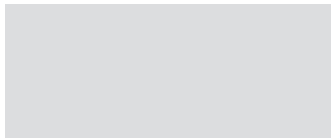

Code

1T1898

my-SCENARIO Show Store.

Digital devices designed to control dynamic lighting fixtures and programme dynamic light scenarios and sequences.

The system consists of intuitive software, compatible with Windows operating systems, able to control different hardware devices with the following functions: - record colour-changing scenarios set by the operator; - allow selection among the multiple scenarios already recorded; - transmit the control signals to the lighting system.

The software is interfaced to the PC through a USB port; the interface with lighting fixtures is featured through a DMX 512 output.

The software provides a graphic simulation of the operating keys of a lighting controller; the patching function allows the DMX control channels to be assigned to fixtures by using the internal library.

The Colour Manager function allows for quick and intuitive programming of a RGB light show, consisting of several steps with assigned duration and fading times.

The built-in calendar allows full time scheduling of show playback (month, day, hour, minutes, recurring events).

The programmed light shows can be transferred to different control interfaces.

Outdoor

Wall recessed

Wall recessed



708
ZEDGE PRO



719
ZEDGE Line



719
ZEDGE Line
Opal



722
ZEDGE



ZEDGE

GENERAL INFO

Recessed wall mounted fixture,
surface mounted and bollard.

Zedge 63x63mm

Zedge LINE 63x304mm

Zedge LINE OPAL 63x304mm

Zedge PRO 200x200mm

LED

Zedge

Linear boards

From 570lm to 598lm

3000K – 4000K

Ra84

Zedge Line e Zedge Line Opal

Linear boards

From 818lm to 1310lm

2700K – 3000K – 4000K

Ra84

Zedge PRO

2 Chip on board

From 2022lm to 2179lm

2700K – 3000K – 4000K

Ra84

PRODUCT EFFICACY

Zedge until 9lm/W

Zedge LINE until 29lm/W

Zedge PRO until 52lm/W

OPTICS

Zedge

Floor washer

Floor washer + Halo Louvre

Zedge LINE

Floor Washer

Zedge OPAL

Diffuse

Zedge PRO

Floor washer deep

Floor Washer wide

Floor Washer adjustable

POWER SUPPLY

Electronic - DALI - 24V

Casambi control: the DALI version is fitted with special accessories.

MATERIAL

The body of the fixture are made of powder coated die-cast anodised aluminium.

Zedge LINE OPAL complete with polycarbonate screen.

The Zedge range designed in collaboration with the firm Gensler to light passage ways, stairs or corridors with solutions with a simple design yet with extreme attention to detail.

Available in three different sizes and with 24V and 220V integrated drivers.

With the use of special accessories the PRO fixture is also available in a bollard and wall mounted version.





Wall recessed



01



Zedge Pro

The larger and high-performance fixture it is a real floor-washer with an innovative optical system and a design based on a perfect play of proportions, inclined planes, defined corners and sharp edges.

The finishing screen can be installed on the surface or flush with the wall for maximum formal simplicity.

Optical systems is made of two independent beams that can be configured in different ways to produce multiple effects: DEEP, WIDE plus all the effects in between with the innovative ADJUSTABLE version.

Wall recessed

02



Bollard and Wall mounted versions

Thanks to the special accessories it is now possible to install Zedge PRO even in a Wall mounted and Bollard versions, available in three different heights 400 - 800 - 1000mm.

03

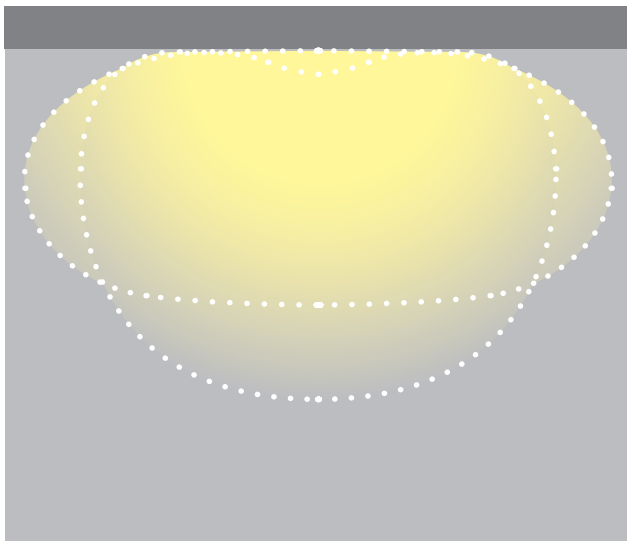
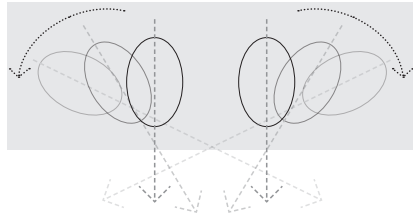

Adjustable Version

An innovative solution that makes it possible to obtain different light effects with the same fixture by calibrating the light beam to suit different project needs. Using an Allen key, it is possible to rotate the optical system changing from a DEEP effect to a WIDE effect fluidly, choosing the most suitable position for the project from among the myriad of intermediary positions.

04

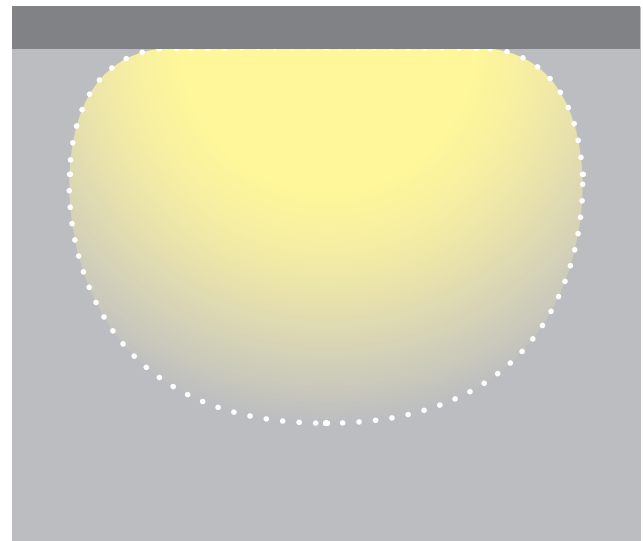
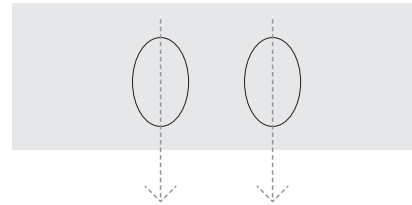

Deep Version

For deep lighting of horizontal surfaces where the priority is to light large open spaces or very wide pathways.

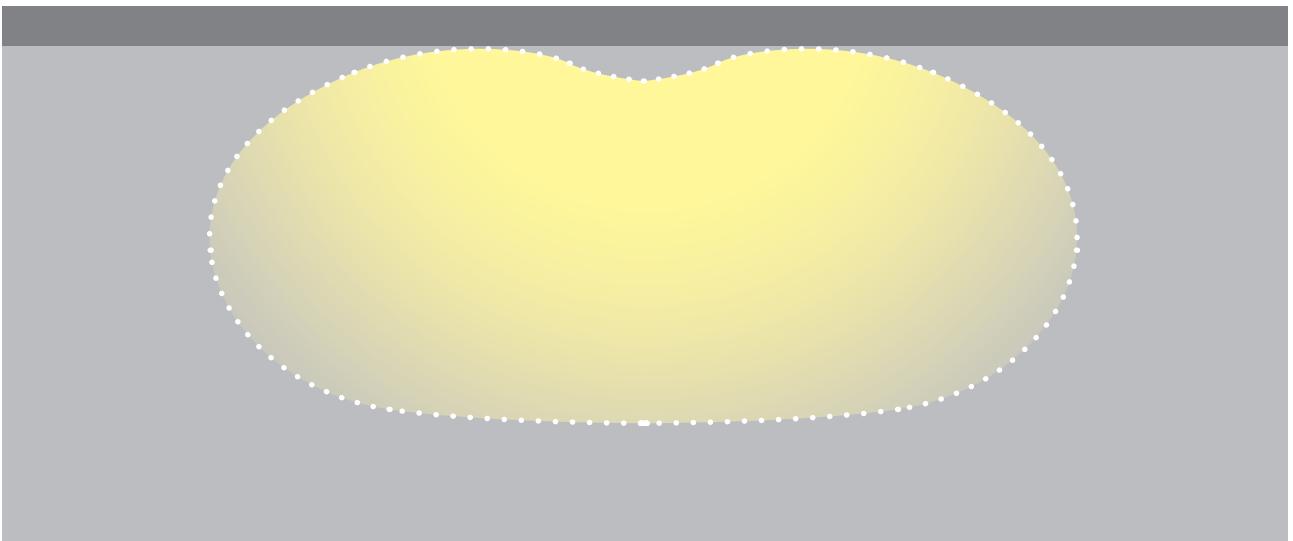
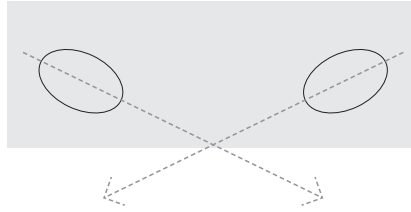

Wide Version

For lighting that favours illuminance uniformity on the longitudinal axis such as long public or private pedestrian walkways.



Double version for Zedge Line

It is the slim and slender version of the line, available in a double version with floor washer reflector for discreet and controlled illumination of the walking surface and in the new OPAL version for softer and more diffuse outdoor lighting.

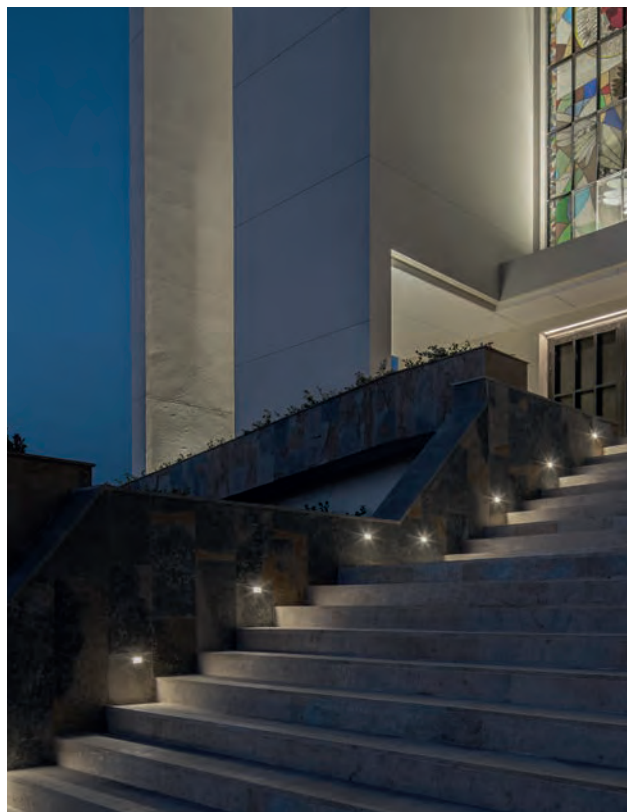

The smaller version is a real step-marker

It has perfect design proportions, maximum attention to detail and with a mild, delicate and comfortable lighting effect. Designed for outdoor lighting but it's extremely compact size - 6cm x 6cm – combined with the possibility to choose from 13 different colour finishes make it a functional and decorative element that can be used even for indoor installations.

Depending on different design requirements it can be installed using an accessory outer casing or directly in the plasterboard. The decorative screen only 5mm thick, simplifies and finishes any installation. Depending on the driver chosen it is possible to connect and power up to 45 fixtures in parallel connection.



Zedge Bollard

New small bollard step-marker from the ZEDGE range. Small, high performance with high visual comfort and excellent light distribution on the floor. Available in a 24V version to be powered by a 230V/24Vdc electronic transformer as an accessory and dimmable with a special accessory kit. To complete with a fixing system.

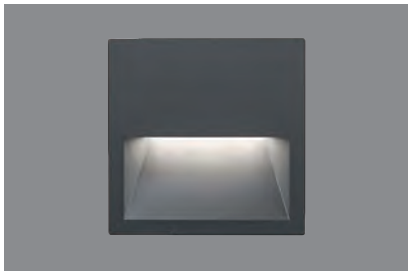

Pro

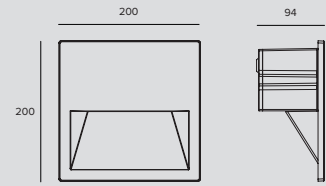

LED / 13W / DEEP

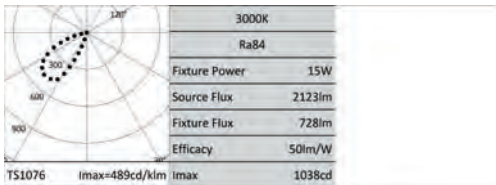

Driver	Colour	2700K	3000K	3500K	4000K
EL.	●	1E3192EL	1E3195EL	1E3760EL	1E3198EL
DALI	●	1E3192DA	1E3195DA	1E3760DA	1E3198DA

LED / 13W / WIDE

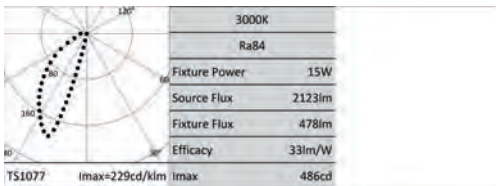

Driver	Colour	2700K	3000K	3500K	4000K
EL.	●	1E3201EL	1E3204EL	1E3761EL	1E3207EL
DALI	●	1E3201DA	1E3204DA	1E3761DA	1E3207DA

LED / 13W / ADJUSTABLE

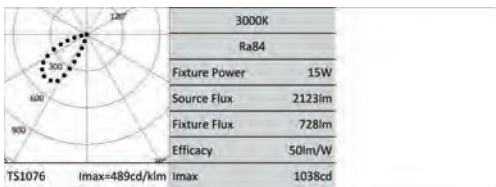

Driver	Colour	2700K	3000K	3500K	4000K
EL.	●	1E3210EL	1E3213EL	1E3762EL	1E3216EL
DALI	●	1E3210DA	1E3213DA	1E3762DA	1E3216DA

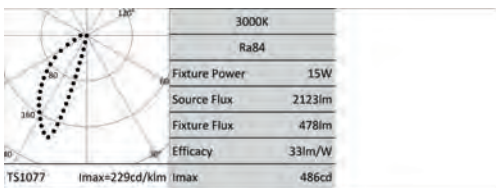

Related codes

Insertion Box



Code

1E3219

Nylon outer casing fitted for parallel connection with feed through-wiring.
AxH=207x207x114.5mm.

Bollard



L	P	H	Colour	Code
200	115	400	●	1E3437
200	115	800	●	1E3438
200	115	1000	●	1E3439

Powder coated anodised aluminium bollard.

ZEDGE

Mounting System



Code

1E3450

Fixing rods for installation in concrete 147x30x28mm.
AISI 316 stainless steel.
For Bollard installation.

Carter

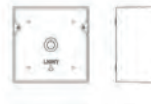

Colour

Code



1E3440

Plate accessory for wall mounted installation.
Powder coated anodised aluminium.
AxBxH=201x201x107mm.

Accessories

Connector



Code

1E2769

Connectors kit for 5 pole coaxial connections.

Control systems



Code

1E3048

A IP67 Module for individual control of external devices equipped with DALI drivers.
The module needs to be positioned in order to receive radio signals.
The distance to the lighting fixtures can reach up to 50m.



Code

1E3049

IP67 Extender for wireless control of DALI fixtures.
It generates a local DALI bus with the capacity to drive up to 64 fixtures.
Can control DALI fixtures in outdoor applications.

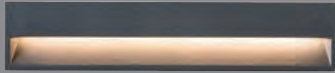

Line

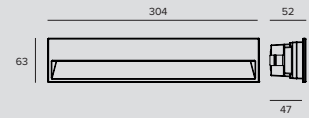

LED / 6W / FLOOR WASHER

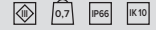

		3000K	H(m)	D1(m)	D2(m)	E _{max} (lx)	
		Ra84		48°	88°		
Fixture Power		7W	1	1.90	2.12	115	
Source Flux		870lm	2	3.80	4.25	29	
Fixture Flux		171lm	3	5.70	6.37	13	
Efficacy		24lm/W	4	7.60	8.49	7	
TS1128	<i>i</i> _{max} =174cd/klm	<i>i</i> _{max}	151cd	5	9.50	10.61	5

Power supply	Colour	2700K	3000K	3500K	4000K
24Vdc	●	1E3441	1E3445	1E3763	1E3446

LED / 8W / FLOOR WASHER

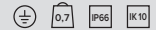

		3000K	H(m)	D1(m)	D2(m)	E _{max} (lx)	
		Ra84		48°	88°		
Fixture Power		9W	1	1.90	2.12	165	
Source Flux		1250lm	2	3.80	4.25	41	
Fixture Flux		245lm	3	5.70	6.37	18	
Efficacy		27lm/W	4	7.60	8.49	10	
TS1128	<i>i</i> _{max} =174cd/klm	<i>i</i> _{max}	217cd	5	9.50	10.61	7

Driver	Colour	2700K	3000K	3500K	4000K
EL	●	1E3442EL	1E3443EL	1E3764EL	1E3444EL
DALI	●	1E3442DA	1E3443DA	1E3764DA	1E3444DA



Line Opal

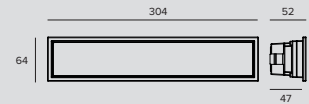

LED / 6W / VWFL

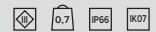

		3000K	H(m)	D(m)	E _{max} (lx)	
		Ra84		116°		
Fixture Power		7W	1	3.21	175	
Source Flux		898lm	2	6.42	44	
Fixture Flux		515lm	3	9.63	19	
Efficacy		74lm/W	4	12.84	11	
TS1181	<i>i</i> _{max} =195cd/klm	<i>i</i> _{max}	175cd	5	16.06	7

Power supply	Colour	2700K	3000K	3500K	4000K
24Vdc	●	1E3511	1E3513	1E3765	1E3515

LED / 8W / VWFL

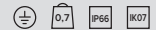

		3000K	H(m)	D(m)	E _{max} (lx)	
		Ra84		116°		
Fixture Power		8W	1	3.19	177	
Source Flux		876lm	2	6.38	44	
Fixture Flux		517lm	3	9.57	20	
Efficacy		65lm/W	4	12.76	11	
TS1182	<i>i</i> _{max} =202cd/klm	<i>i</i> _{max}	177cd	5	15.95	7

Driver	Colour	2700K	3000K	3500K	4000K
EL	●	1E3512EL	1E3514EL	1E3766EL	1E3516EL
DALI	●	1E3512DA	1E3514DA	1E3766DA	1E3516DA

ZEDGE

Related codes

Power Supply

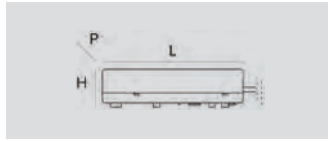

Code

10W - 220-240Vac, 24Vdc - 79x24,5x38mm - IP67	1E3179
50W - 220-240Vac, 24Vdc - 185x22x63,5mm - IP20	1T3726
75W - 220-240Vac, 24Vdc - 130x32x80mm - IP67	1T3586
100W - 220-240Vac, 24Vdc - 230x87x43mm - IP67	1T3587
200W - 220-240Vac, 24Vdc - 238x42x67mm - IP67	1T3588

Electronic power supply
LxHxP



Code

1E0993

Electronic power supply max 20W, Ø98 h78, 220/240V-AC, 24V-DC, IP68.

Insertion Box

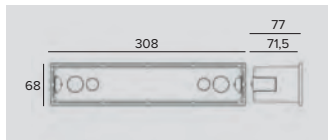

Code

1E3447

Nylon outer casing fitted for parallel connection with feed through-wiring.

Mounting System



Code

1T7003

Stainless steel spring kit for installation without insertion box.

Accessories

Control systems

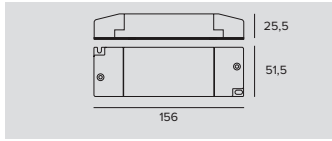

Code

1T6581

DALI/1-10V dimmer 12/24V.

Connector

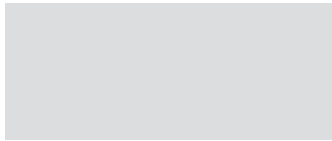

Code

1E2494

Non DALI looping connector.
1 IN - 3 OUT 4 poles max. wire section 2.5mm².
Cable diameter range from 8 to 12mm.
IP68

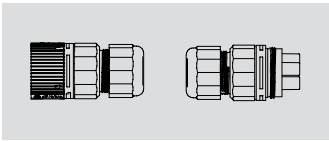

Code

1E2769

Connectors kit for 5 pole coaxial connections.

Control systems

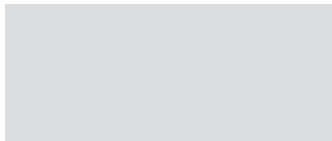

Code

1E3048

A IP67 Module for individual control of external devices equipped with DALI drivers.
The module needs to be positioned in order to receive radio signals.
The distance to the lighting fixtures can reach up to 50m.

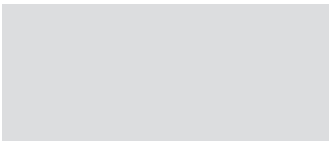

Code

1E3049

IP67 Extender for wireless control of DALI fixtures.
It generates a local DALI bus with the capacity to drive up to 64 fixtures.
Can control DALI fixtures in outdoor applications.

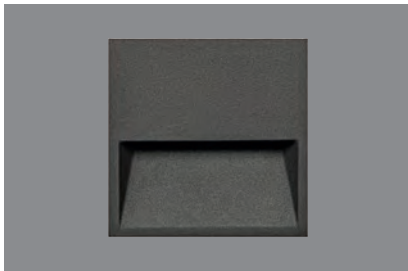

Floor Washer

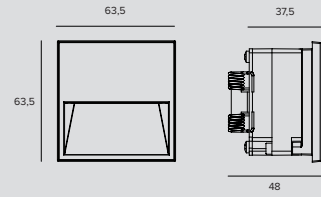

LED / 4W



		3000K	H(m)	D1(m)	D2(m)	E _{max} (lx)	
Ra84			55°	86°			
Fixture Power	5W	1	2.62	2.11	23		
Source Flux	570lm	2	5.25	4.22	6		
Fixture Flux	40lm	3	7.87	6.33	3		
Efficacy	7lm/W	4	10.50	8.44	1		
TS999	Imax=53cd/klm	Imax	30cd	5	13.12	10.55	1

Power supply	Colour	2700K	3000K	3500K	4000K
24Vdc	○	1E3742	1E3154	1E3745	1E3157
24Vdc	●	1E3743	1E3160	1E3746	1E3163
24Vdc	●	1E3744	1E3148	1E3747	1E3151



Floor Washer + Halo

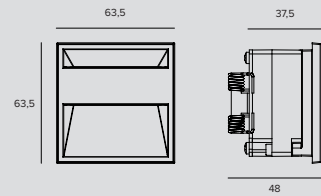

LED / 4W



		3000K	H(m)	D1(m)	D2(m)	E _{max} (lx)	
Ra84			56°	90°			
Fixture Power	5W	1	2.82	2.30	23		
Source Flux	570lm	2	5.65	4.60	6		
Fixture Flux	46lm	3	8.47	6.90	3		
Efficacy	9lm/W	4	11.30	9.19	1		
TS1000	Imax=54cd/klm	Imax	31cd	5	14.12	11.49	1

Power supply	Colour	2700K	3000K	3500K	4000K
24Vdc	○	1E3748	1E3155	1E3751	1E3158
24Vdc	●	1E3749	1E3161	1E3752	1E3164
24Vdc	●	1E3750	1E3149	1E3753	1E3152



Louvre

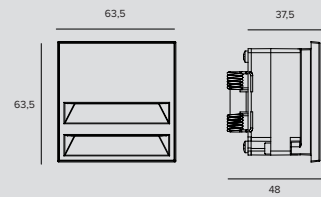

LED / 4W



		3000K	H(m)	D1(m)	D2(m)	E _{max} (lx)	
Ra84			49°	94°			
Fixture Power	5W	1	14.87	3.25	8		
Source Flux	570lm	2	29.74	6.50	2		
Fixture Flux	33lm	3	44.60	9.75	1		
Efficacy	6lm/W	4	59.47	13.00	0		
TS1001	Imax=46cd/klm	Imax	26cd	5	74.34	16.26	0

Power supply	Colour	2700K	3000K	3500K	4000K
24Vdc	○	1E3754	1E3156	1E3757	1E3159
24Vdc	●	1E3755	1E3162	1E3758	1E3165
24Vdc	●	1E3756	1E3150	1E3759	1E3153

Related codes

Power Supply

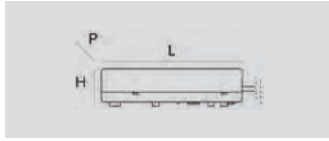

	Code
10W - 220-240Vac, 24Vdc - 79x24,5x38mm - IP67	1E3179
50W - 220-240Vac, 24Vdc - 185x22x63,5mm - IP20	1T3726
75W - 220-240Vac, 24Vdc - 130x32x80mm - IP67	1T3586
100W - 220-240Vac, 24Vdc - 230x87x43mm - IP67	1T3587
200W - 220-240Vac, 24Vdc - 238x42x67mm - IP67	1T3588

Electronic power supply
LxHxP

	Code
	1E0993

Electronic power supply max 20W, Ø98 h78, 220/240V-AC, 24V-DC, IP68.

Accessories

Insertion Box

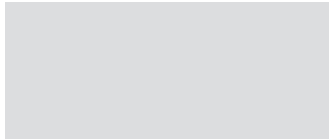
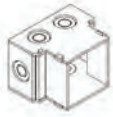

	Code
	1E3166

Outer casing in plastic material fitted for parallel connection with feed through-wiring.
For the fixture.
Cutout hole AxBxP=87x59x72.5mm.

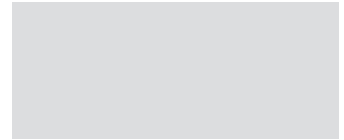
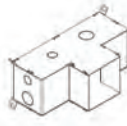

	Code
	1E3180

Stainless steel outer casing fitted for parallel connection with feed through-wiring.
For fixture + driver.
Cutout hole AxBxP=166x72x87mm.

Control systems

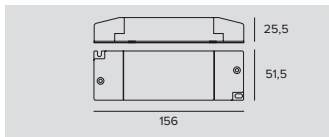

	Code
	1T6581

DALI/1-10V dimmer 12/24V.

Terminal Box

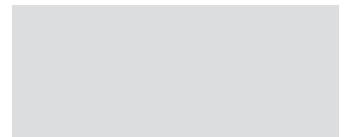

	Code
	1E3181

Terminal box with gel.

Control systems



Code

1E3048

A IP67 Module for individual control of external devices equipped with DALI drivers. The module needs to be positioned in order to receive radio signals. The distance to the lighting fixtures can reach up to 50m.



Code

1E3049

IP67 Extender for wireless control of DALI fixtures. It generates a local DALI bus with the capacity to drive up to 64 fixtures. Can control DALI fixtures in outdoor applications.



Wall recessed

Outdoor

Surface luminaires

Surface luminaires



730
MR SMITH



737
MRS SMITH



740
FEBO EVO



728
Q-BO



746
STILO



758
HOCKEY



Q-BO

IP67

GENERAL INFO

Wall and ceiling mounted fixture
for grazing light effect.
Side 160mm

LED

Chip on board
From 4122lm to 4228lm
3000K – 4000K
Ra84

PRODUCT EFFICACY

Unitil 84lm/W

OPTICS

Reflector Optics
BI-EMISSION – PLURI-EMISSION

POWER SUPPLY

Electronic

MATERIAL

Painted die-cast anodised aluminium body.

A ceiling or wall mounted fixture for grazing light effect available in two versions, bi-emission direct/indirect or pluri-emission.

The range of accessories the fixture can be completed with make it possible to create scenographic lighting effects on the surface to be illuminated and to tailor the light beam according to specific project requirements.



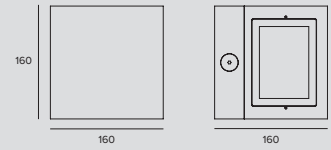

LED / 29W / BI-DIRECTIONAL EMISSION / VWFL ⊕ 6.5 IP67

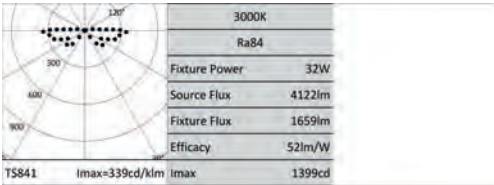

Driver	Colour	3000K	4000K
EL.	●	1E2956	1E2957

LED / 29W / MULTIDIRECTIONAL / VWFL ⊕ 6.5 IP67

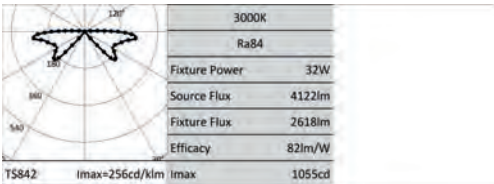

Driver	Colour	3000K	4000K
EL.	●	1E2958	1E2959

Accessories

Shaper

Code
1E2953

Blade of light (4/6°).
Equipped with micrometric adjustability to obtain perfect light beam direction.

Code
1E2954

Narrow blade of light (10/12°).
Equipped with micrometric adjustability to obtain perfect light beam direction.

Code
1E2960

Louvre.
Beam width 50°.

Code
1E2961

Louvre.
Beam width 30°.

Shutter

Code
1E2955

Shutter.
To be mounted outside the fixture.

Mr & Mrs SMITH

GENERAL INFO

Wall mounted LED fixtures.
Mr Smith 130x130x51.5mm
Mrs Smith 305x63.6x51.5mm

LED

LED Chip on board high efficacy
From 388lm to 1217lm
2700K – 3000K – 4000K
Ra84
Ra90 - To order this version it is necessary to add the suffix "90" at the end of the standard code.

PRODUCT EFFICACY

Unitil 97m/W

OPTICS

Direct - Indirect - Direct/indirect

POWER SUPPLY

Electronic – DALI - 24V

MATERIAL

Anodized and painted extruded aluminium body.
Injection-moulded opal polycarbonate screen.

New applique for outdoor installation. Available in two different versions: Square shaped Mr Smith and rectangular shaped Mrs Smith for wall mounted installations with direct fixing on the back of the product. Both versions are available with different emissions: indirect, direct and direct/indirect.







Double geometry and easy installation

130x130 square solution and 63x300 rectangular solution, both made up of two elements for quick mounting without visible screws and an overall clean effect. The base is attached to the installation surface and the body of the device, which has different sections based on the type of emission, is attached to it.



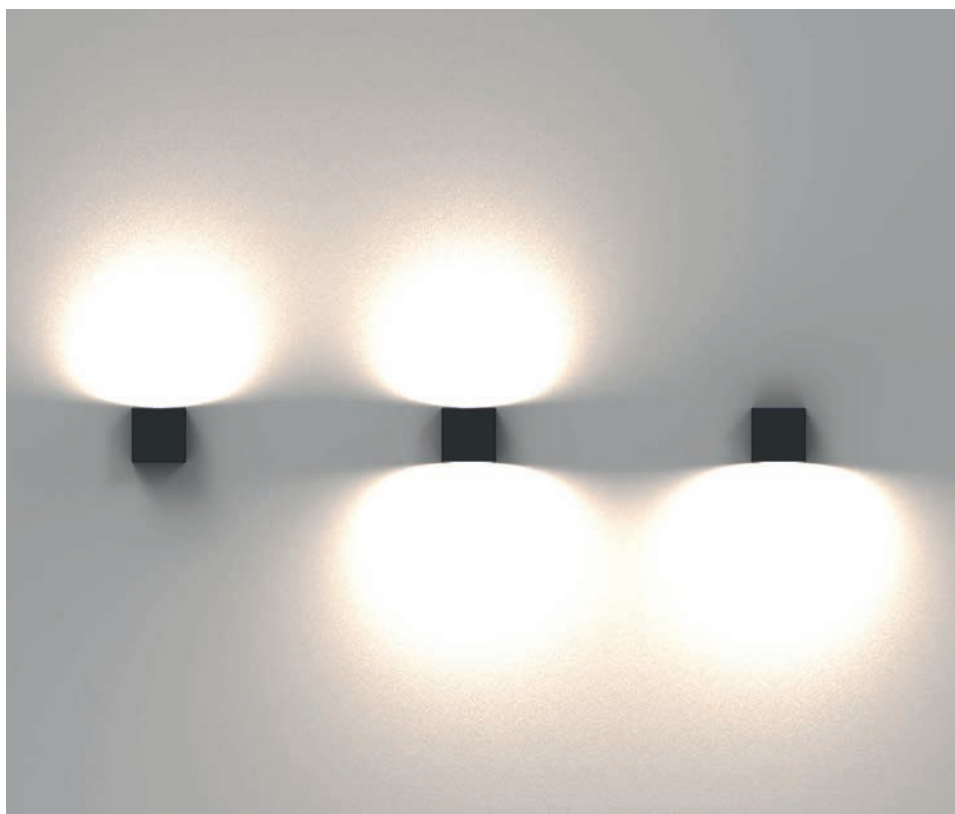

Three light skimming effects

Direct, indirect, and direct/indirect emission.

The direct light version has an inclined plane at the bottom that, together with the opal polycarbonate screen, softly accompanies the light recalling the design of the ZEDGE Series.

In the version with only indirect or direct/indirect emission the polycarbonate screen at the top softly diffuses the light.

MR & MRS SMITH

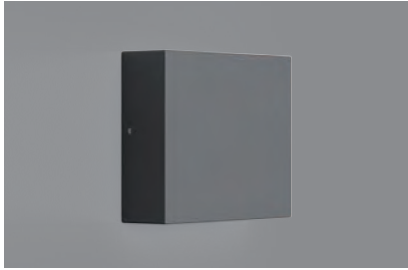

MR SMITH

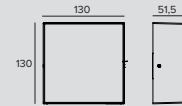

LED / 6W / FLOOD / DIRECT									
		3000K		H(m)	D1(m)	D2(m)	E _{max} (lx)		
		Ra84			102°	64°			
Fixture Power	7W	1	2.46	1.26	296				
Source Flux	896lm	2	4.91	2.51	74				
Fixture Flux	490lm	3	7.37	3.77	33				
Efficacy	70lm/W	4	9.82	5.03	18				
TS1198	I _{max} =330cd/klm	I _{max}	296cd	5	12.28	6.29	12		

Driver	Colour	2700K	3000K	4000K
		1E3528	1E3530	1E3532

Note

24V version to be powered with an electronic 230V/24Vdc transformer available as an accessory and dimmable with the special accessory kit.

LED / 6W / FLOOD / DIRECT									
		3000K		H(m)	D1(m)	D2(m)	E _{max} (lx)		
		Ra84			102°	64°			
Fixture Power	7W	1	2.46	1.26	315				
Source Flux	954lm	2	4.91	2.51	79				
Fixture Flux	522lm	3	7.37	3.77	35				
Efficacy	75lm/W	4	9.82	5.03	20				
TS1198	I _{max} =330cd/klm	I _{max}	315cd	5	12.28	6.29	13		

Driver	Colour	2700K	3000K	4000K
EL.		1E3527EL	1E3529EL	1E3531EL
DALI		1E3527DA	1E3529DA	1E3531DA

LED / 6W / FLOOD / INDIRECT								
		3000K						
		Ra84						
Fixture Power	7W							
Source Flux	896lm							
Fixture Flux	624lm							
Efficacy	89lm/W							
TS1197	I _{max} =379cd/klm	I _{max}	340cd					

Driver	Colour	2700K	3000K	4000K
		1E3522	1E3524	1E3526

Note

24V version to be powered with an electronic 230V/24Vdc transformer available as an accessory and dimmable with the special accessory kit.

LED / 6W / FLOOD / INDIRECT								
		3000K						
		Ra84						
Fixture Power	7W							
Source Flux	954lm							
Fixture Flux	664lm							
Efficacy	95lm/W							
TS1197	I _{max} =379cd/klm	I _{max}	361cd					

Driver	Colour	2700K	3000K	4000K
EL.		1E3521EL	1E3523EL	1E3525EL
DALI		1E3521DA	1E3523DA	1E3525DA

LED / 12W / FLOOD / DIRECT/INDIRECT



		3000K	H(m)	D1(m)	D2(m)	E _{max} (lx)	
		Ra84		102°	64°		
Fixture Power	14W	1	2.46	1.26	296		
Source Flux	1793lm	2	4.91	2.51	74		
Fixture Flux	1115lm	3	7.37	3.77	33		
Efficacy	80lm/W	4	9.82	5.03	18		
TS1199	I _{max} =184cd/klm	I _{max}	330cd	5	12.28	6.29	12

Driver	Colour	2700K	3000K	4000K
		1E3534	1E3536	1E3538

Note

24V version to be powered with an electronic 230V/24Vdc transformer available as an accessory and dimmable with the special accessory kit.

LED / 11,7W / FLOOD / DIRECT/INDIRECT



		3000K	H(m)	D1(m)	D2(m)	E _{max} (lx)	
		Ra84		102°	64°		
Fixture Power	13W	1	2.46	1.26	315		
Source Flux	1907lm	2	4.91	2.51	79		
Fixture Flux	1186lm	3	7.37	3.77	35		
Efficacy	91lm/W	4	9.82	5.03	20		
TS1199	I _{max} =184cd/klm	I _{max}	351cd	5	12.28	6.29	13

Driver	Colour	2700K	3000K	4000K
EL.		1E3533EL	1E3535EL	1E3537EL
DALI		1E3533DA	1E3535DA	1E3537DA

Related codes

Power Supply

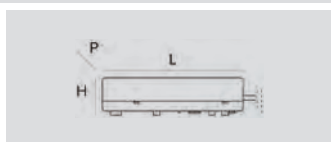

Code

10W - 220-240Vac, 24Vdc - 79x24,5x38mm - IP67	1E3179
50W - 220-240Vac, 24Vdc - 185x22x63,5mm - IP20	1T3726
75W - 220-240Vac, 24Vdc - 130x32x80mm - IP67	1T3586
100W - 220-240Vac, 24Vdc - 230x87x43mm - IP67	1T3587
200W - 220-240Vac, 24Vdc - 238x42x67mm - IP67	1T3588

Electronic power supply
LxHxP



Code

1E0993

Electronic power supply max 20W, Ø98 h78, 220/240V-AC, 24V-DC, IP68.

Accessories

Control systems

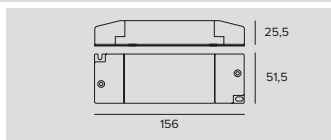

Code

1T6581

DALI/1-10V dimmer 12/24V.



Code

1E3048

A IP67 Module for individual control of external devices equipped with DALI drivers. The module needs to be positioned in order to receive radio signals. The distance to the lighting fixtures can reach up to 50m.



Code

1E3049

IP67 Extender for wireless control of DALI fixtures. It generates a local DALI bus with the capacity to drive up to 64 fixtures. Can control DALI fixtures in outdoor applications.

MR & MRS SMITH

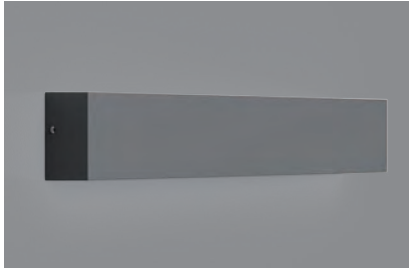

MRS SMITH

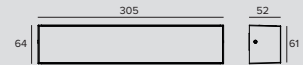

LED / 6,1W / FLOOD / DIRECT

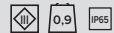

		3000K	H(m)		D1(m)		D2(m)		Emax(lx)	
		Ra84		76°	93°					
Fixture Power	7W	1	1.60	2.12	302					
Source Flux	870lm	2	3.21	4.25	75					
Fixture Flux	494lm	3	4.81	6.37	34					
Efficacy	72lm/W	4	6.41	8.50	19					
TS1202	Imax=348cd/klm	Imax	302cd	5	8.02	10.62	12			

Power supply	Colour	2700K	3000K	4000K
24Vdc	●	1E3546	1E3548	1E3550

LED / 6,1W / FLOOD / DIRECT

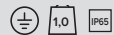

		3000K	H(m)		D1(m)		D2(m)		Emax(lx)	
		Ra84		76°	93°					
Fixture Power	7W	1	1.60	2.12	302					
Source Flux	870lm	2	3.21	4.25	75					
Fixture Flux	494lm	3	4.81	6.37	34					
Efficacy	72lm/W	4	6.41	8.50	19					
TS1202	Imax=348cd/klm	Imax	302cd	5	8.02	10.62	12			

Driver	Colour	2700K	3000K	4000K
EL.	●	1E3545EL	1E3547EL	1E3549EL
DALI	●	1E3545DA	1E3547DA	1E3549DA

LED / 6,1W / FLOOD / INDIRECT

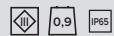

		3000K	H(m)		D1(m)		D2(m)		Emax(lx)	
		Ra84		76°	93°					
Fixture Power	7W	1	1.60	2.12	302					
Source Flux	870lm	2	3.21	4.25	75					
Fixture Flux	554lm	3	4.81	6.37	34					
Efficacy	80lm/W	4	6.41	8.50	19					
TS1200	Imax=342cd/klm	Imax	298cd							

Power supply	Colour	2700K	3000K	4000K
24Vdc	●	1E3540	1E3542	1E3544

Note

24V version to be powered with an electronic 230V/24Vdc transformer available as an accessory and dimmable with the special accessory kit.

LED / 6,1W / FLOOD / INDIRECT

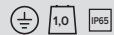

		3000K	H(m)		D1(m)		D2(m)		Emax(lx)	
		Ra84		76°	93°					
Fixture Power	7W	1	1.60	2.12	302					
Source Flux	870lm	2	3.21	4.25	75					
Fixture Flux	554lm	3	4.81	6.37	34					
Efficacy	80lm/W	4	6.41	8.50	19					
TS1200	Imax=342cd/klm	Imax	298cd							

Driver	Colour	2700K	3000K	4000K
EL.	●	1E3539EL	1E3541EL	1E3543EL
DALI	●	1E3539DA	1E3541DA	1E3543DA

LED / 12W / FLOOD / DIRECT/INDIRECT







		3000K	H(m)	D1(m)	D2(m)	Emax(lx)	
		Ra84		76°	93°		
Fixture Power	14W	1	1.60	2.12	289		
Source Flux	1740lm	2	3.21	4.24	72		
Fixture Flux	1050lm	3	4.81	6.37	32		
Efficacy	76lm/W	4	6.41	8.49	18		
TS1204	Imax=177cd/klm	Imax	308cd	5	8.01	10.61	12



Power supply	Colour	2700K	3000K	4000K
24Vdc		1E3552	1E3554	1E3556

Note

24V version to be powered with an electronic 230V/24Vdc transformer available as an accessory and dimmable with the special accessory kit.

LED / 12W / FLOOD / DIRECT/INDIRECT



		3000K	H(m)	D1(m)	D2(m)	Emax(lx)	
		Ra84		76°	93°		
Fixture Power	14W	1	1.60	2.12	289		
Source Flux	1740lm	2	3.21	4.24	72		
Fixture Flux	1050lm	3	4.81	6.37	32		
Efficacy	76lm/W	4	6.41	8.49	18		
TS1204	Imax=177cd/klm	Imax	308cd	5	8.01	10.61	12

Driver	Colour	2700K	3000K	4000K
EL.		1E3551EL	1E3553EL	1E3555EL
DALI		1E3551DA	1E3553DA	1E3555DA

Related codes

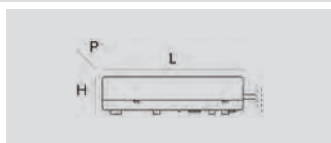
Power Supply



	Code
10W - 220-240Vac, 24Vdc - 79x24,5x38mm - IP67	1E3179
50W - 220-240Vac, 24Vdc - 185x22x63,5mm - IP20	1T3726
75W - 220-240Vac, 24Vdc - 130x32x80mm - IP67	1T3586
100W - 220-240Vac, 24Vdc - 230x87x43mm - IP67	1T3587
200W - 220-240Vac, 24Vdc - 238x42x67mm - IP67	1T3588
Electronic power supply LxHxP	

	Code
Electronic power supply max 20W, Ø98 h78, 220/240V-AC, 24V-DC, IP68.	1E0993

MR & MRS SMITH

Accessories

Control systems

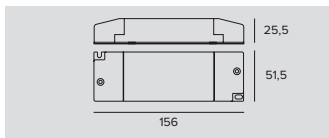

Code

1T6581

DALI/1-10V dimmer 12/24V.



Code

1E3048

A IP67 Module for individual control of external devices equipped with DALI drivers. The module needs to be positioned in order to receive radio signals. The distance to the lighting fixtures can reach up to 50m.



Code

1E3049

IP67 Extender for wireless control of DALI fixtures.
It generates a local DALI bus with the capacity to drive up to 64 fixtures.
Can control DALI fixtures in outdoor applications.



FEBO EVO

GENERAL INFO

Inground or wall fixture with grazing light effect.
ø160mm – H 150mm

LED

Multiple sources circuit, mid-power

LED

From 4452lm to 5038lm

2700K – 3000K – 4000K

Ra84

PRODUCT EFFICACY

Unitil 76m/W

OPTICS

Grazing

POWER SUPPLY

Electronic – DALI

Casambi control: the DALI version is fitted with special accessories.

MATERIAL

Extruded aluminium body, die-cast aluminium optical head with black radial blades.

Inground or wall mounted LED fixture with grazing lighting effect with unbroken radial 360° emission that can be controlled using accessories to modulate the light as if it were a second skin.

The light emitted is capable of adhering perfectly to architectural surfaces and to emphasize textures and the consistency of different materials. Its compact design integrates harmoniously with the architecture making it a discrete element even during the daytime.





Studio Ceri

Architect
Studio Ceri

Photographer
Officine
Fotografiche

Country
Prato - Italy

01



Installed on the floor FEBO EVO

Is a reliable tool with minimal visual impact capable of lighting paths in depth and breadth, or separating different areas using light. It is installed on the ground with a simple support base that is supplied.

02



It is in wall installations that FEBO EVO shows its potential the most

This sophisticated fixture emits a 360° blade of light without any interruptions that is capable of adhering to every surface like a second skin.

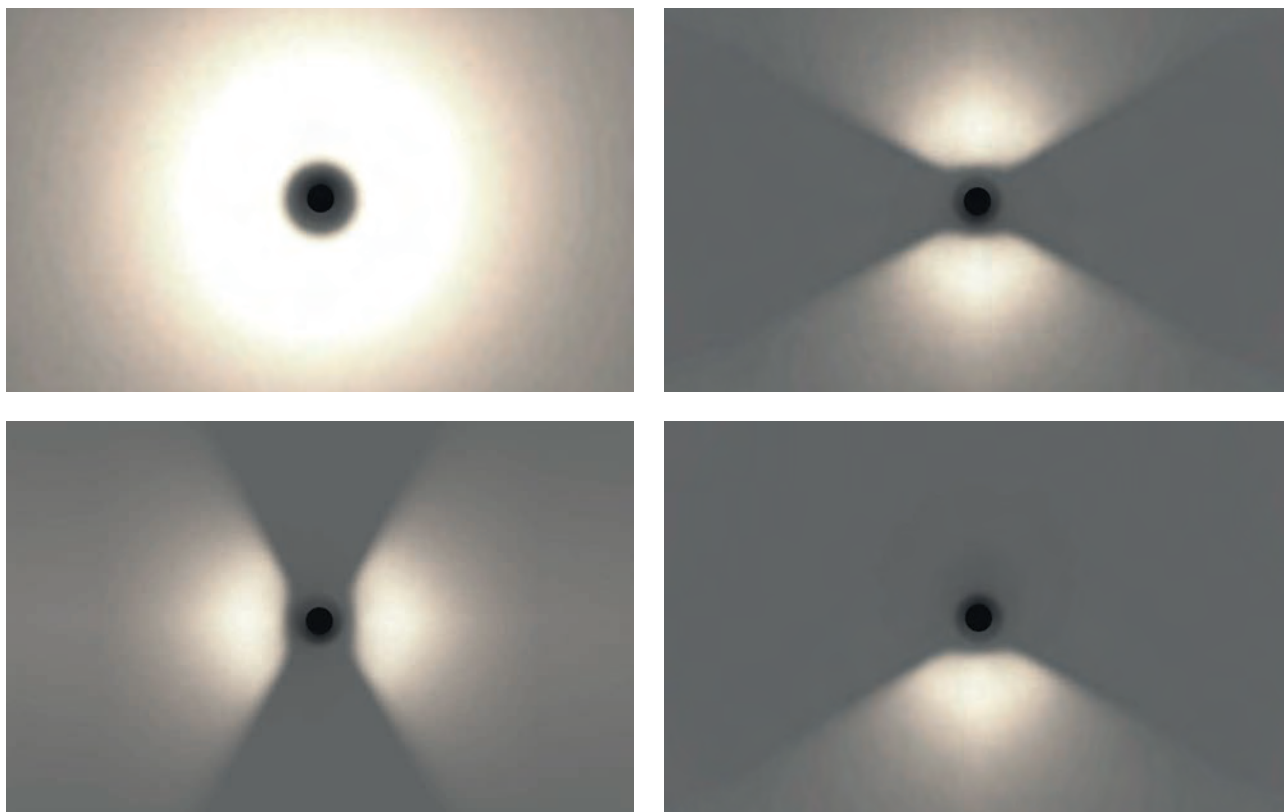

With the use of accessories

The light from FEBO EVO can be shaped according to needs. Simple rubber elements, combined, coordinated or cut can be positioned at any point so that they "design" the light that best suits the project needs..

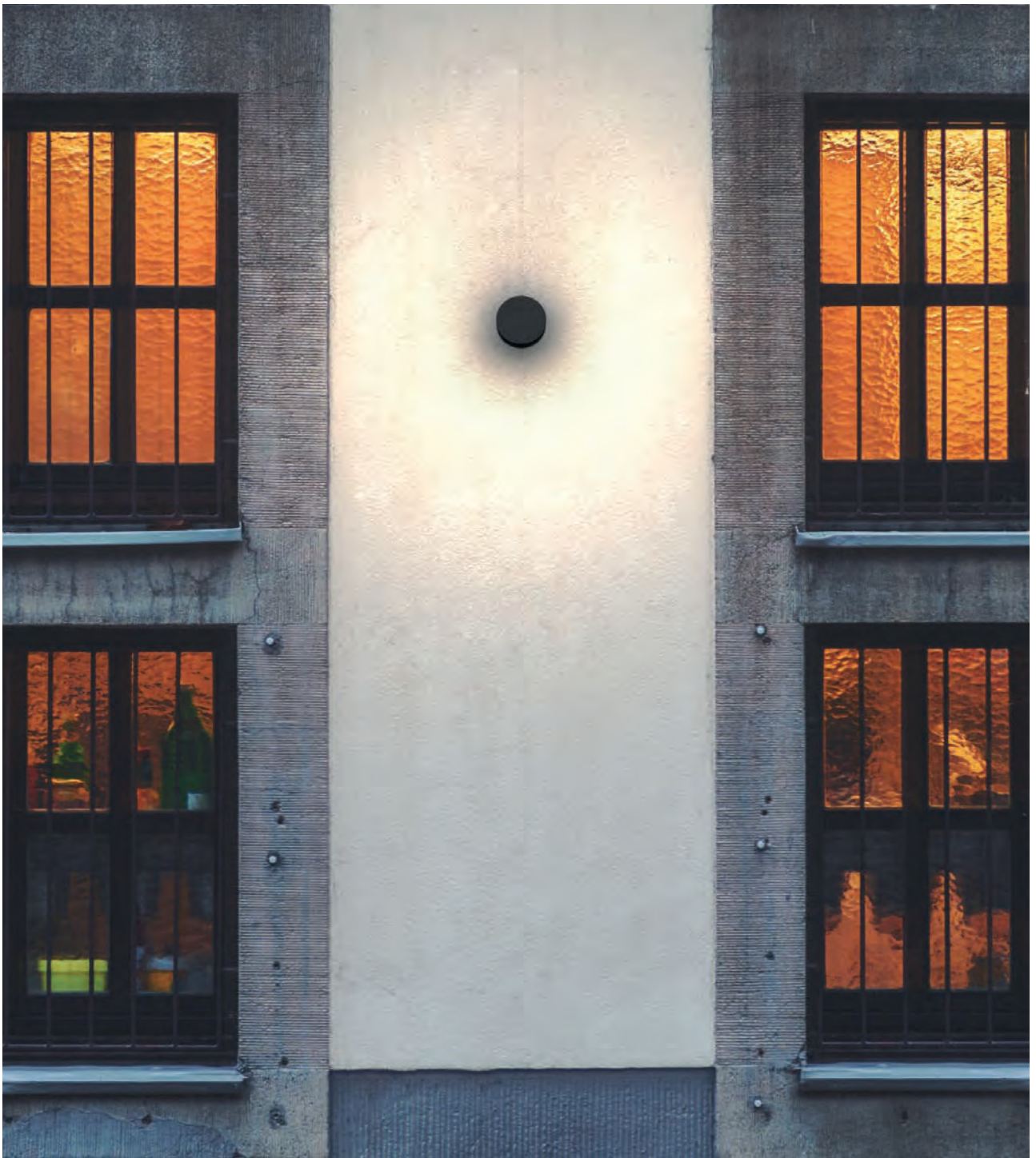

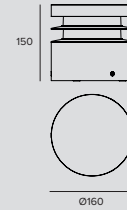

LED / 32W / WFL □ 2.5 IP67 ENEC

	3000K
	Ra84
	Fixture Power 36W
	Source Flux 4787lm
	Fixture Flux 2585lm
TS1071	Efficacy 72lm/W
	Imax=218cd/klm
	Imax 1042cd

Driver	2700K	3000K	4000K
EL.	1E3189EL	1E3190EL	1E3191EL
DALI	1E3189DA	1E3190DA	1E3191DA

Accessories

Shutter

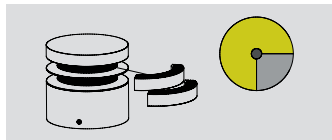

Code

1E3399

120° shutter kit (with 4 cut zones that allow to shutter even 105°/90°/75°/60° angles).
Max. no. of kits per product: 2.

Tool



Code

1E3305

(Tightening) wrench for the connector kit.

Control systems



Code

1E3048

A IP67 Module for individual control of external devices equipped with DALI drivers.
The module needs to be positioned in order to receive radio signals.
The distance to the lighting fixtures can reach up to 50m.



Code

1E3049

IP67 Extender for wireless control of DALI fixtures.
It generates a local DALI bus with the capacity to drive up to 64 fixtures.
Can control DALI fixtures in outdoor applications.

STILO

Wall mounted Ceiling mounted

GENERAL INFO

Wall-mounted fixture.
282x80x184mm

LED

ASY and ELL optic: LED Chip on board
NSP optic: LED Emitter
Effect optic: LED Multichip Emitter
From 600lm to 6536lm
3000K – 4000K
Ra80 – Ra84

PRODUCT EFFICACY

Unitil 112lm/W

OPTICS

NSP – EFFECT – ASYM – ELLIPTICAL

POWER SUPPLY

Electronic

MATERIAL

Anodized and painted extruded aluminium body
and anodized and powder coated die-cast aluminium
optical unit and terminal. Tempered glass
protective screen.

A range of products with the same design but with different installation characteristics: from architectural lighting of building facades and porticos right up to pedestrian walkways. Different needs and effects with a unique family feeling; wall mounted versions, ceiling mounted and bollards that produce a myriad of lighting effects, from purely graphic and defined effects to wider beams that fill large spaces





Arma

Architect
SKiP Architectural
Bureau

Photographer
Ilya Melikhov

Country
Moscow - Russian
Federation

01



Available in two installation types

FLAT (parallel to the wall) and STRAIGHT (perpendicular to the wall), both available in mono and bi-emission versions.

02



The ceiling mounted version

Are ideal to light porticos, the different optics make it possible to light pedestrian areas or vertical walls.

Stilo is available with four different optical solutions

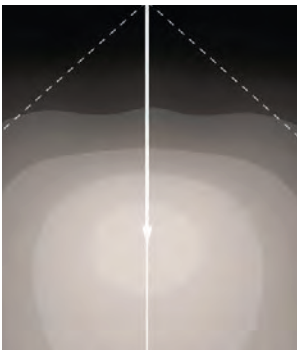

ELLIPTICAL EMISSION

Using it like a grazing lighting is ideal to illuminate the building facades.

The ceiling mounted versions allows to light pedestrian areas in a particularly uniform way,

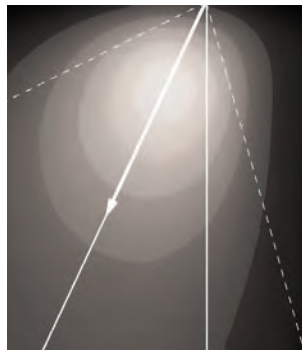

ASYMMETRIC EMISSION

Installed for indirect emission to light arches and direct emission for pedestrian areas.

The ceiling mounted version can also be used to light walls.

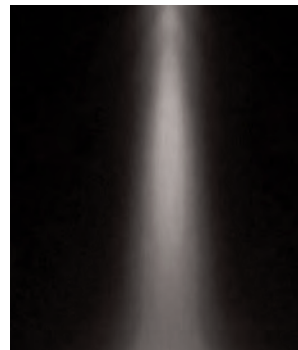

SUPERSPOT EMISSION

Has a particularly concentrated and defined effect that is suitable for lighting a facade.



DEFINED EFFECTS

Real light patterns on the wall from a blade light beam as thin as a pin, to wider, yet defined effects with beam angles of 30° and 90°.

STILO



Wall Flat

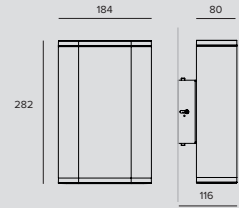

LED / 1x9W / NSP / MONO-EMISSION □ 2.5 IP66 IK09

		3000K	H(m)	D(m)	E _{max} (lx)	
Ra80				9°		
Fixture Power	12W	1	0.16	13011		
Source Flux	650lm	2	0.32	3253		
Fixture Flux	544lm	3	0.48	1446		
Efficacy	47lm/W	4	0.64	813		
TS791	I _{max} =20017cd/klm	I _{max}	13011cd	5	0.80	520

Driver	Colour	3000K	4000K
EL.	●	1E2547	
EL.	●	1E2556	1E2881

LED / 1x11W / EFFECT / MONO-EMISSION □ 2.5 IP66 IK09

		3000K	H(m)	D1(m)	D2(m)	E _{max} (lx)	
Ra80				68°	95°		
Fixture Power	15W	1	1.36	2.19	189		
Source Flux	600lm	2	2.72	4.39	47		
Fixture Flux	292lm	3	4.08	6.58	21		
Efficacy	20lm/W	4	5.44	8.78	12		
TS788	I _{max} =315cd/klm	I _{max}	189cd	5	6.80	10.97	8

Driver	Colour	3000K	4000K
EL.	●	1E2882	1E2883

LED / 2x9W / NSP-NSP / BI-EMISSION □ 3 IP66 IK09

		3000K	H(m)	D(m)	E _{max} (lx)	
Ra80				9°		
Fixture Power	20W	1	0.16	13011		
Source Flux	1300lm	2	0.32	3253		
Fixture Flux	1087lm	3	0.48	1446		
Efficacy	54lm/W	4	0.64	813		
TS824	I _{max} =10009cd/klm	I _{max}	13011cd	5	0.80	520

Driver	Colour	3000K	4000K
EL.	●	1E2551	
EL.	●	1E2560	1E2887

LED / 2x11W / EFFECT-EFFECT / BI-EMISSION □ 3 IP66 IK09

		3000K	H(m)	D1(m)	D2(m)	E _{max} (lx)	
Ra80				68°	95°		
Fixture Power	27W	1	1.36	2.19	189		
Source Flux	1200lm	2	2.72	4.39	47		
Fixture Flux	584lm	3	4.08	6.58	21		
Efficacy	22lm/W	4	5.44	8.78	12		
TS814	I _{max} =157cd/klm	I _{max}	189cd	5	6.80	10.97	8

Driver	Colour	3000K	4000K
EL.	●	1E2888	1E2889

Note

EFFECT Version: the fixture comes equipped with a 90° beam aperture. The beam can be shaped using shutter accessories.

LED / 1x21W / ASYM / MONO-EMISSION □ 2.5 IP66 IK09

	3000K	H(m)	D1(m)	D2(m)	E _{max} (lx)		
	Ra84		61°	86°			
	Fixture Power	23W	1	1.51	1.98	1356	
	Source Flux	3187lm	2	3.01	3.96	339	
	Fixture Flux	2304lm	3	4.52	5.94	151	
	Efficacy	100lm/W	4	6.02	7.92	85	
	TS787	I _{max} =464cd/klm	I _{max}	1480cd	5	7.53	9.89

Driver	Colour	3000K	4000K
EL.		1E2543	
EL.		1E2552	1E2877

LED / 1x21W / ELLIPTICAL / MONO-EMISSION □ 2.5 IP66 IK09

	3000K	H(m)	D1(m)	D2(m)	E _{max} (lx)		
	Ra84		42°	79°			
	Fixture Power	23W	1	0.76	1.66	2266	
	Source Flux	3187lm	2	1.52	3.31	567	
	Fixture Flux	2530lm	3	2.28	4.97	252	
	Efficacy	110lm/W	4	3.04	6.62	142	
	TS786	I _{max} =711cd/klm	I _{max}	2266cd	5	3.80	8.28

Driver	Colour	3000K	4000K
EL.		1E2545	
EL.		1E2554	1E2879

LED / 1x33W / ASYM / MONO-EMISSION □ 2.5 IP66 IK09

	3000K	H(m)	D1(m)	D2(m)	E _{max} (lx)		
	Ra84		61°	86°			
	Fixture Power	36W	1	1.51	1.98	1860	
	Source Flux	4373lm	2	3.01	3.96	465	
	Fixture Flux	3162lm	3	4.52	5.94	207	
	Efficacy	89lm/W	4	6.02	7.92	116	
	TS787	I _{max} =464cd/klm	I _{max}	2031cd	5	7.53	9.89

Driver	Colour	3000K	4000K
EL.		1E2544	
EL.		1E2553	1E2878

LED / 1x33W / ELLIPTICAL / MONO-EMISSION □ 2.5 IP66 IK09

	3000K	H(m)	D1(m)	D2(m)	E _{max} (lx)		
	Ra84		42°	79°			
	Fixture Power	36W	1	0.76	1.66	3110	
	Source Flux	4373lm	2	1.52	3.31	777	
	Fixture Flux	3471lm	3	2.28	4.97	346	
	Efficacy	97lm/W	4	3.04	6.62	194	
	TS786	I _{max} =711cd/klm	I _{max}	3110cd	5	3.80	8.28

Driver	Colour	3000K	4000K
EL.		1E2546	
EL.		1E2555	1E2880

Note



EFFECT Version: the fixture comes equipped with a 90° beam aperture. The beam can be shaped using shutter accessories.

STILO

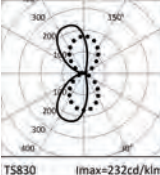
LED / 2x21W / ASYM-ASYM / BI-EMISSION □ 3 IP66 IK09





	3000K	H(m)	D1(m)	D2(m)	E _{max} (lx)
Ra84			61°	86°	
Fixture Power	46W	1	1.51	1.98	1356
Source Flux	6375lm	2	3.01	3.96	339
Fixture Flux	4609lm	3	4.52	5.94	151
Efficacy	100lm/W	4	6.02	7.92	85
TS830	l _{max} =232cd/klm	l _{max}	1480cd	5	7.53 9.89 54

Driver	Colour	3000K	4000K
EL.		1E2548	
EL.		1E2557	1E2884

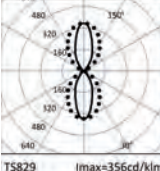
LED / 2x21W / ELLIPTICAL-ELLIPTICAL / BI-EMISSION □ 3 IP66 IK09





	3000K	H(m)	D1(m)	D2(m)	E _{max} (lx)
Ra84			42°	79°	
Fixture Power	46W	1	0.76	1.66	2267
Source Flux	6375lm	2	1.52	3.31	567
Fixture Flux	5060lm	3	2.28	4.97	252
Efficacy	109lm/W	4	3.04	6.62	142
TS829	l _{max} =356cd/klm	l _{max}	2267cd	5	3.80 8.28 91

Driver	Colour	3000K	4000K
EL.		1E2549	
EL.		1E2558	1E2885

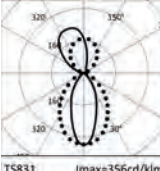
LED / 2x21W / ELLIPTICAL-ASYM / BI-EMISSION □ 3 IP66 IK09



	3000K	H(m)	D1(m)	D2(m)	E _{max} (lx)
Ra84			42°	79°	
Fixture Power	46W	1	0.76	1.66	2267
Source Flux	6375lm	2	1.52	3.31	567
Fixture Flux	4835lm	3	2.28	4.97	252
Efficacy	104lm/W	4	3.04	6.62	142
TS831	l _{max} =356cd/klm	l _{max}	2267cd	5	3.80 8.28 91

Driver	Colour	3000K	4000K
EL.		1E2550	
EL.		1E2559	1E2886

Note

EFFECT Version: the fixture comes equipped with a 90° beam aperture. The beam can be shaped using shutter accessories.

Accessories

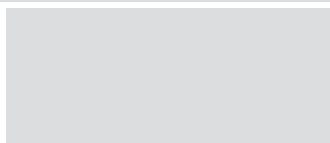

Filter

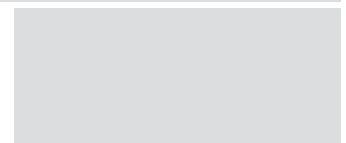

Filter	Code
Red	1E3035
Green	1E3036
Blue	1E3037
Yellow	1E3038
Magenta	1E3039

Chromatic coloured PMMA filter, anodised powder coated frame (ferrite).



Colour	Code
	1E2575
	1E2576

Blade of light filter.
PMMA holographic filter for a blade of light effect, CNC machine anodised and powder coated aluminium frame.
NSP

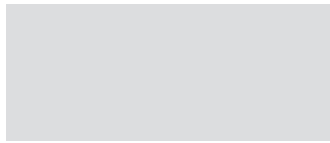

Colour	Code
	1E2577
	1E2578

Anti-glare.
PMMA holographic filter to reduce the beam angle, CNC machine anodised and powder coated aluminium frame.
NSP, ASYM, ELLIPTICAL

Shaper

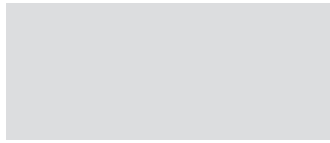

Code
1E2901

30° shutter.
Powder coated stainless steel plate (ferrite).

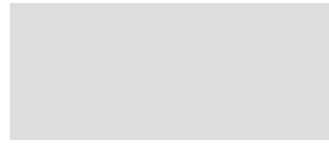

Code
1E2902

Blade effect shutter.
PMMA plano convex cylindrical lens and powder coated stainless steel plate (ferrite).

Screen

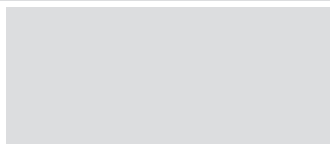

Colour	Code
	1E2579
	1E2580

Asymmetric screen.
Powder coated stainless steel.
NSP

Mounting System

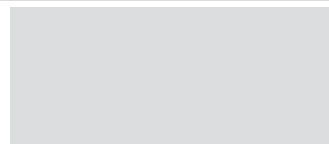

Code
1E2906

Pole bracket.
Powder coated stainless steel.

STILO

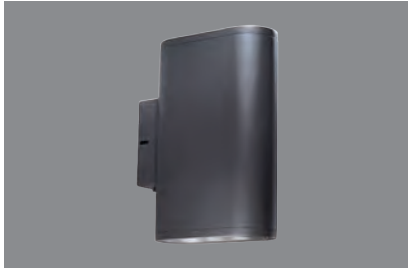

Wall Straight

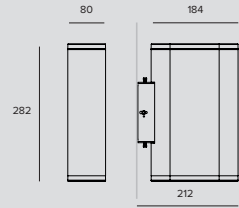

LED / 1x9W / NSP / MONO-EMISSION



	3000K	H(m)	D(m)	E _{max} (lx)
Ra80			9°	
Fixture Power	12W	1	0.16	13011
Source Flux	650lm	2	0.32	3253
Fixture Flux	544lm	3	0.48	1446
Efficacy	47lm/W	4	0.64	813
TS791	I _{max} =20017cd/klm	I _{max}	13011cd	5 0.80 520

Driver	Colour	3000K	4000K
EL.	●	1E2894	1E2895

LED / 1x21W / ELLIPTICAL / MONO-EMISSION



	3000K	H(m)	D1(m)	D2(m)	E _{max} (lx)
Ra84			42°	79°	
Fixture Power	23W	1	0.76	1.66	2266
Source Flux	3187lm	2	1.52	3.31	567
Fixture Flux	2530lm	3	2.28	4.97	252
Efficacy	110lm/W	4	3.04	6.62	142
TS786	I _{max} =711cd/klm	I _{max}	2266cd	5 3.80 8.28 91	

Driver	Colour	3000K	4000K
EL.	●	1E2890	1E2891

LED / 1x33W / ELLIPTICAL / MONO-EMISSION

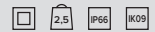

	3000K	H(m)	D1(m)	D2(m)	E _{max} (lx)
Ra84			42°	79°	
Fixture Power	36W	1	0.76	1.66	3110
Source Flux	4373lm	2	1.52	3.31	777
Fixture Flux	3471lm	3	2.28	4.97	346
Efficacy	97lm/W	4	3.04	6.62	194
TS786	I _{max} =711cd/klm	I _{max}	3110cd	5 3.80 8.28 124	

Driver	Colour	3000K	4000K
EL.	●	1E2892	1E2893

LED / 2x9W / NSP-NSP / BI-EMISSION

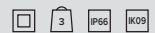

	3000K	H(m)	D(m)	E _{max} (lx)
Ra80			9°	
Fixture Power	20W	1	0.16	13011
Source Flux	1300lm	2	0.32	3253
Fixture Flux	1087lm	3	0.48	1446
Efficacy	54lm/W	4	0.64	813
TS824	I _{max} =10009cd/klm	I _{max}	13011cd	5 0.80 520

Driver	Colour	3000K	4000K
EL.	●	1E2898	1E2899

LED / 2x21W / ELLIPTICAL-ELLIPTICAL / BI-EMISSION

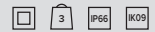

	3000K	H(m)	D1(m)	D2(m)	E _{max} (lx)
Ra84			42°	79°	
Fixture Power	46W	1	0.76	1.66	2267
Source Flux	6375lm	2	1.52	3.31	567
Fixture Flux	5060lm	3	2.28	4.97	252
Efficacy	109lm/W	4	3.04	6.62	142
TS829	I _{max} =356cd/klm	I _{max}	2267cd	5 3.80 8.28 91	

Driver	Colour	3000K	4000K
EL.	●	1E2896	1E2897

Accessories

Filter

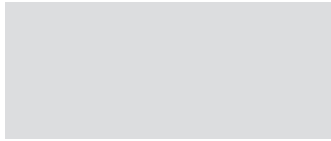

Filter	Code
Red	1E3035
Green	1E3036
Blue	1E3037
Yellow	1E3038
Magenta	1E3039

Chromatic coloured PMMA filter, anodised powder coated frame (ferrite).

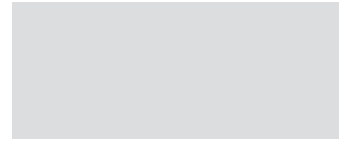

Colour	Code
	1E2576

Blade of light filter.
PMMA holographic filter for a blade of light effect, CNC machine anodised and powder coated aluminium frame.
NSP

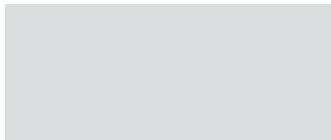

Colour	Code
	1E2578

Anti-glare.
PMMA holographic filter to reduce the beam angle, CNC machine anodised and powder coated aluminium frame.
NSP, ASYM, ELLIPTICAL

Mounting System

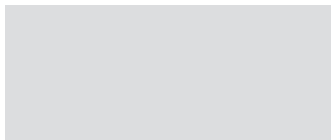

Code
1E2906

Pole bracket.
Powder coated stainless steel.

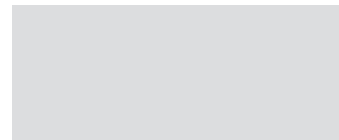

Code
1E2907

Bracket for corner installation.
Powder coated stainless steel.



Code
1E2900

Bracket for edge installation.
Powder coated stainless steel.

STILO



Ceiling

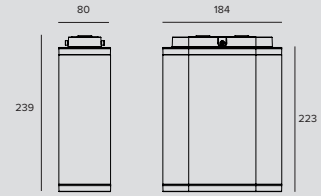

LED / 9W / NSP



	3000K	H(m)	D(m)	E _{max} (lx)
Ra80			9°	
Fixture Power	12W	1	0.16	13011
Source Flux	650lm	2	0.32	3253
Fixture Flux	544lm	3	0.48	1446
Efficacy	47lm/W	4	0.64	813
TS791	I _{max} =20017cd/klm	I _{max}	13011cd	5 0.80 520

Driver	Colour	3000K	4000K
EL.	●	1E2875	1E2876

LED / 21W / ASYM

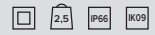

	3000K	H(m)	D1(m)	D2(m)	E _{max} (lx)
Ra84			61°	86°	
Fixture Power	23W	1	1.51	1.98	1356
Source Flux	3187lm	2	3.01	3.96	339
Fixture Flux	2304lm	3	4.52	5.94	151
Efficacy	100lm/W	4	6.02	7.92	85
TS787	I _{max} =464cd/klm	I _{max}	1480cd	5 7.53 9.89	54

Driver	Colour	3000K	4000K
EL.	●	1E2871	1E2872

LED / 21W / ELLIPTICAL



	3000K	H(m)	D1(m)	D2(m)	E _{max} (lx)
Ra84			42°	79°	
Fixture Power	23W	1	0.76	1.66	2266
Source Flux	3187lm	2	1.52	3.31	567
Fixture Flux	2530lm	3	2.28	4.97	252
Efficacy	110lm/W	4	3.04	6.62	142
TS786	I _{max} =711cd/klm	I _{max}	2266cd	5 3.80 8.28	91

Driver	Colour	3000K	4000K
EL.	●	1E2867	1E2868

LED / 33W / ASYM



	3000K	H(m)	D1(m)	D2(m)	E _{max} (lx)
Ra84			61°	86°	
Fixture Power	36W	1	1.51	1.98	1860
Source Flux	4373lm	2	3.01	3.96	465
Fixture Flux	3162lm	3	4.52	5.94	207
Efficacy	89lm/W	4	6.02	7.92	116
TS787	I _{max} =464cd/klm	I _{max}	2031cd	5 7.53 9.89	74

Driver	Colour	3000K	4000K
EL.	●	1E2873	1E2874

LED / 33W / ELLIPTICAL



	3000K	H(m)	D1(m)	D2(m)	E _{max} (lx)
Ra84			42°	79°	
Fixture Power	36W	1	0.76	1.66	3110
Source Flux	4373lm	2	1.52	3.31	777
Fixture Flux	3471lm	3	2.28	4.97	346
Efficacy	97lm/W	4	3.04	6.62	194
TS786	I _{max} =711cd/klm	I _{max}	3110cd	5 3.80 8.28	124

Driver	Colour	3000K	4000K
EL.	●	1E2869	1E2870

Accessories

Filter

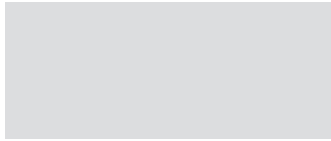

Filter	Code
Red	1E3035
Green	1E3036
Blue	1E3037
Yellow	1E3038
Magenta	1E3039

Chromatic coloured PMMA filter, anodised powder coated frame (ferrite).

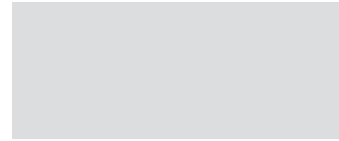

Colour	Code
●	1E2576

Blade of light filter.
PMMA holographic filter for a blade of light effect, CNC machine anodised and powder coated aluminium frame.
NSP

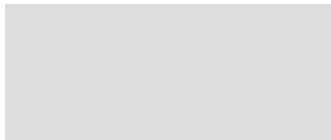

Colour	Code
●	1E2578

Anti-glare.
PMMA holographic filter to reduce the beam angle, CNC machine anodised and powder coated aluminium frame.
NSP, ASYM, ELLIPTICAL

Screen

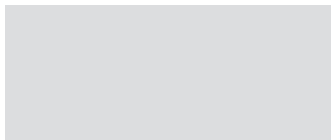

Colour	Code
●	1E2580

Asymmetric screen.
Powder coated stainless steel.
NSP

HOCKEY

GENERAL INFO

Applique, ceiling mounted
ø179mm

LED

LED board.
From 1533lm to 1632lm
3000K – 4000K
Ra84

PRODUCT EFFICACY

Unitil 109lm/W

OPTICS

VWFL

POWER SUPPLY

Electronic

MATERIAL

Die-cast ferrite colour anodised aluminium body.
LED plate with micro-prismatic diffuser in transparent
PMMA.

A compact fixture with a simple design with two different installation types- ceiling and wall mounted for direct light- that makes this a flexible tool in the hands of lighting designers.

In the wall mounted version the cast aluminium bracket echoes the fixture's rounded shape becoming part of its design.





Ceiling

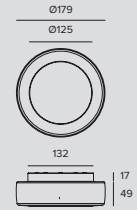

LED / 13W / VWFL



	3000K	H(m)	D(m)	Emax(lx)
Ra84			84°	
Fixture Power	15W	1	1.80	839
Source Flux	1533lm	2	3.60	210
Fixture Flux	1533lm	3	5.40	93
Efficacy	102lm/W	4	7.20	52
EV328	imax=548cd/klm	imax	840cd	5
			9.00	34

Driver	Colour	3000K	4000K
EL.	●	1E2911	1E2912



Wall

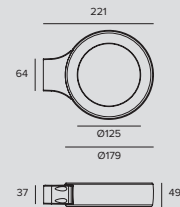

LED / 13W / VWFL

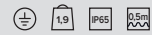

	3000K	H(m)	D(m)	Emax(lx)
Ra84			84°	
Fixture Power	15W	1	1.80	839
Source Flux	1533lm	2	3.60	210
Fixture Flux	1533lm	3	5.40	93
Efficacy	102lm/W	4	7.20	52
EV328	imax=548cd/klm	imax	840cd	5
			9.00	34

Driver	Colour	3000K	4000K
EL.	●	1E2909	1E2910

Outdoor

Bollards

Bollards



762
MR. BO



768
CHIODINO



772
STILO



776
ZEDGE Bollard

Mr.BO

GENERAL INFO

Radial-emission bollard.
ø160mm
H 400mm – 800mm – 1000mm

LED

Chip on board
From 1427lm to 3817lm
2700K – 3000K – 4000K
Ra84
Ra90 upon request

PRODUCT EFFICACY

Unitil 51lm/W

OPTICS

90° - 90° + 90° - 180° - 360°

POWER SUPPLY

Electronic – DALI
Casambi control: the DALI version is fitted with special accessories.

MATERIAL

Powdered coated anodised die-cast aluminium body.
Die-cast aluminium optical head. Ferrite finish.

LED bollard specifically designed to light large open spaces.

Its mechanical characteristics (IK10) and performance make it possible to use in every space.

The highly controlled radial emission avoids any risk of glare while still ensuring deep lighting in pedestrian areas.





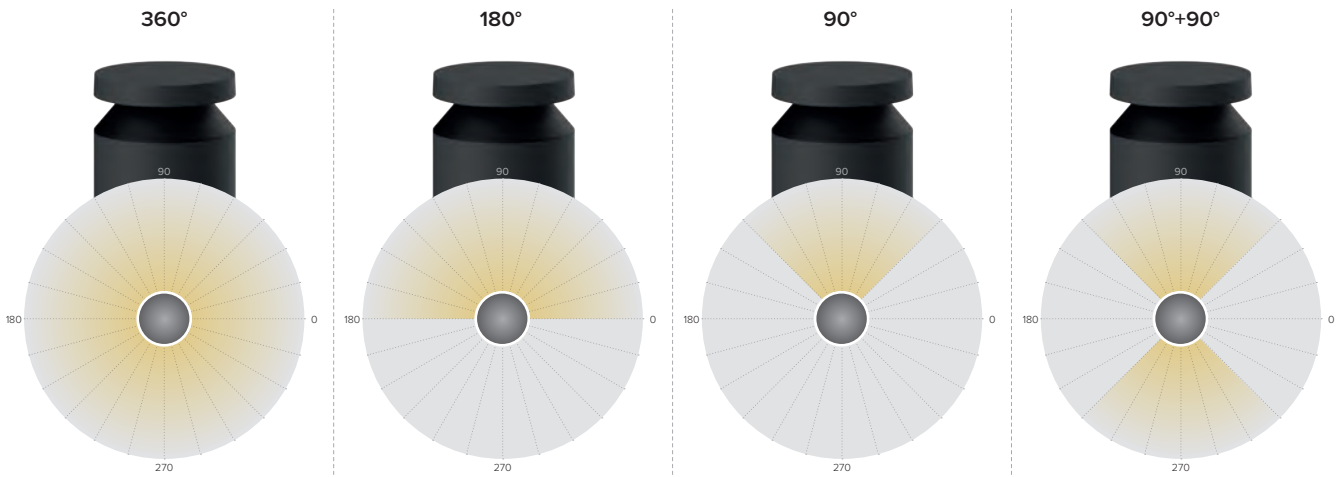

The fixture is made of three different elements

that combined together produce numerous combinations. Four different light heads for four radial emissions from 90° a 360° combine with stakes in three different heights of 334mm, 734mm and 934mm and with the mounting systems.

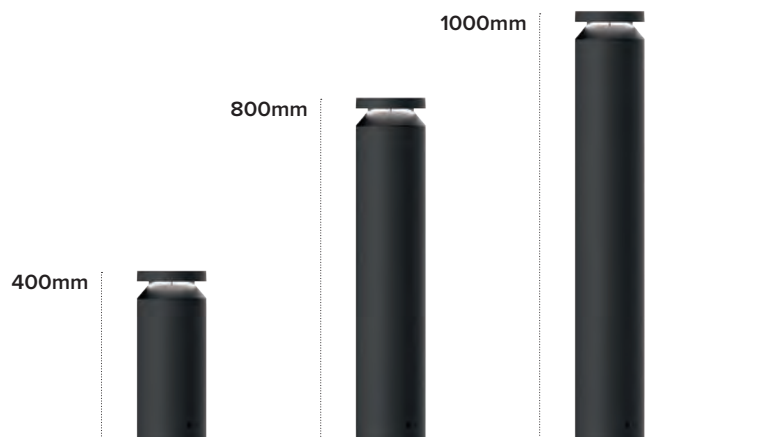
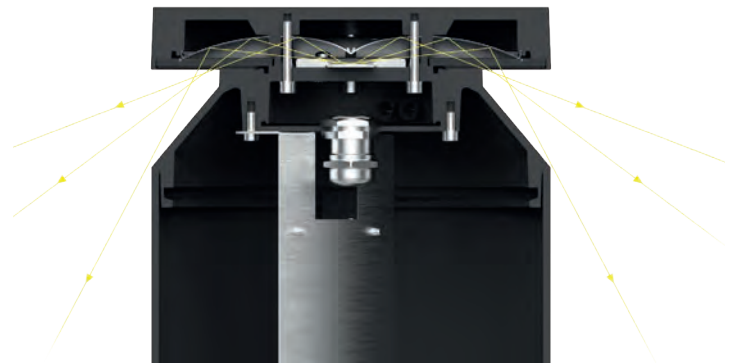



Optic head for bollard H. 334mm

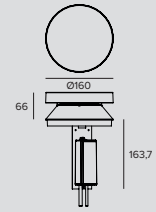

LED / 8W / 90° □ 1.4 IP66 IK10

	3000K	
	Ra84	
	Fixture Power	9W
	Source Flux	1488lm
	Fixture Flux	223lm
	Efficacy	26lm/W
TS1120	Imax=165cd/klm	Imax

Driver	Colour	2700K	3000K	4000K
EL.	●	1E3428EL	1E3429EL	1E3430EL
DALI	●	1E3428DA	1E3429DA	1E3430DA

LED / 12W / 90°+90° □ 1.4 IP66 IK10

	3000K	
	Ra84	
	Fixture Power	14W
	Source Flux	2034lm
	Fixture Flux	456lm
	Efficacy	34lm/W
TS1121	Imax=122cd/klm	Imax

Driver	Colour	2700K	3000K	4000K
EL.	●	1E3431EL	1E3432EL	1E3433EL
DALI	●	1E3431DA	1E3432DA	1E3433DA

LED / 12W / 180° □ 1.4 IP66 IK10

	3000K	H(m)	D1(m)	D2(m)	E _{max} (lx)		
	Ra84		43°	90°			
	Fixture Power	14W	1	3.07	13.22	76	
	Source Flux	2034lm	2	6.14	26.45	19	
	Fixture Flux	454lm	3	9.21	39.67	8	
	Efficacy	34lm/W	4	12.28	52.89	5	
TS1119	Imax=146cd/klm	Imax	297cd	5	15.35	66.11	3

Driver	Colour	2700K	3000K	4000K
EL.	●	1E3425EL	1E3426EL	1E3427EL
DALI	●	1E3425DA	1E3426DA	1E3427DA

LED / 17W / 360° □ 1.4 IP66 IK10

	3000K	H(m)	D(m)	E _{max} (lx)		
	Ra84		41°			
	Fixture Power	18W	1	2.58	79	
	Source Flux	2783lm	2	5.95	20	
	Fixture Flux	910lm	3	8.93	9	
	Efficacy	50lm/W	4	11.91	5	
TS1118	Imax=100cd/klm	Imax	278cd	5	14.88	3

Driver	Colour	2700K	3000K	4000K
EL.	●	1E3422EL	1E3423EL	1E3424EL
DALI	●	1E3422DA	1E3423DA	1E3424DA

Note

Available with three different height poles - 400, 800 and 1000mm - to be combined with the relative head available in four different versions - 60°, 180°, 90° and 90°+90° (the same code for the 800 and 1000mm, specific code for the 400mm). To be completed with a stainless steel anchoring system, available for the double version with a plate for installation with dowels or with fixing rods for installation in concrete.

MR.BO



Optic head for bollard H. 734/934mm

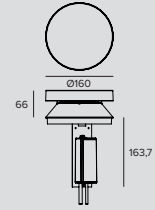

LED / 12W / 90°



	3000K		
	Ra84		
	Fixture Power 14W		
	Source Flux 2034lm		
	Fixture Flux 305lm		
Efficacy 23lm/W			
TS1120	Imax=165cd/klm	Imax	336cd

Driver	Colour	2700K	3000K	4000K
EL.	●	1E3416EL	1E3417EL	1E3418EL
DALI	●	1E3416DA	1E3417DA	1E3418DA

LED / 17W / 90°+90°



	3000K		
	Ra84		
	Fixture Power 18W		
	Source Flux 2783lm		
	Fixture Flux 623lm		
Efficacy 34lm/W			
TS1121	Imax=122cd/klm	Imax	338cd

Driver	Colour	2700K	3000K	4000K
EL.	●	1E3419EL	1E3420EL	1E3421EL
DALI	●	1E3419DA	1E3420DA	1E3421DA

LED / 17W / 180°

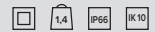

	3000K	H(m)	D1(m)	D2(m)	Emax(lx)		
	Ra84		43°	90°			
	Fixture Power 18W	1	3.07	13.22	104		
	Source Flux 2783lm	2	6.14	26.45	26		
	Fixture Flux 621lm	3	9.21	39.67	12		
Efficacy 34lm/W	4	12.28	52.89	6			
TS1119	Imax=146cd/klm	Imax	407cd	5	15.35	66.11	4

Driver	Colour	2700K	3000K	4000K
EL.	●	1E3413EL	1E3414EL	1E3415EL
DALI	●	1E3413DA	1E3414DA	1E3415DA

LED / 24W / 360°



	3000K	H(m)	D(m)	Emax(lx)		
	Ra84		41°			
	Fixture Power 26W	1	2.98	106		
	Source Flux 3723lm	2	5.95	26		
	Fixture Flux 1217lm	3	8.93	12		
Efficacy 47lm/W	4	11.91	7			
TS1118	Imax=100cd/klm	Imax	372cd	5	14.88	4

Driver	Colour	2700K	3000K	4000K
EL.	●	1E3410EL	1E3411EL	1E3412EL
DALI	●	1E3410DA	1E3411DA	1E3412DA

Note

Available with three different height poles - 400, 800 and 1000mm - to be combined with the relative head available in four different versions - 60°, 180°, 90° and 90°+90° (the same code for the 800 and 1000mm, specific code for the 400mm). To be completed with a stainless steel anchoring system, available for the double version with a plate for installation with dowels or with fixing rods for installation in concrete.

Related codes

Bollard

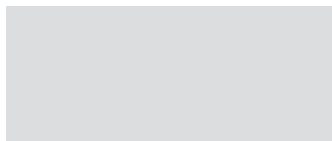
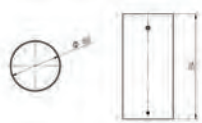

	Kg	H	Colour	Code
	1.34	334	●	1E3434
	2.95	734	●	1E3435
	3.8	934	●	1E3436

Powder coated anodised aluminium pole.

Mounting System

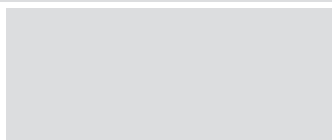

Code

1E3448

Plate with fixing rods for installation in concrete.
AISI 316 stainless steel.
0.335Kg.

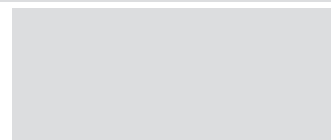

Code

1E3449

Plate for surface installation.
AISI 316 stainless steel compatible with dowels to be inserted into holes with 8.5mm diameter.
0.68Kg.

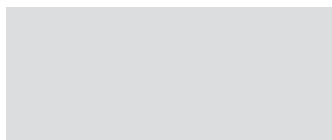

Code

1E3510

Plate for surface installation.
AISI 316 stainless steel compatible with dowels to be inserted into 4 holes with 22mm diameter.
1.104Kg.

Accessories

Control systems

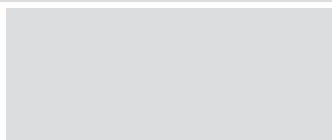

Code

1E3048

A IP67 Module for individual control of external devices equipped with DALI drivers.
The module needs to be positioned in order to receive radio signals.
The distance to the lighting fixtures can reach up to 50m.

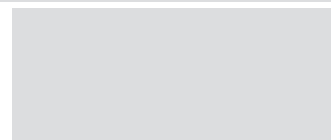

Code

1E3049

IP67 Extender for wireless control of DALI fixtures.
It generates a local DALI bus with the capacity to drive up to 64 fixtures.
Can control DALI fixtures in outdoor applications.

CHIODINO

GENERAL INFO

Radial-emission bollard.

Ø196mm

H 890mm

LED

Chip on board

From 2551lm to 2615lm

3000K – 4000K

Ra84

PRODUCT EFFICACY

Unitil 70lm/W

OPTICS

Radial

POWER SUPPLY

Electronic

MATERIAL

Tapered, anodized aluminium body and die-cast anodized head, both powder painted with a ferrite finish. Ultra flat transparent polycarbonate protective screen.

High performance bollard with sophisticated LED technology and an original design, ideal for public use thanks to its resistant sturdy construction, it is also a popular private option given its appealing design.

Already complete with stainless steel fixing rod.

Plate for surface installation available as an accessory.



01



Thanks to its special, perfectly flat emission screen

CHIODINO takes above horizon emissions to 0cd/klm in compliance with all national and international light pollution laws. This makes it the ideal bollard for public-urban contexts where antipollution regulations are particularly strict.

02

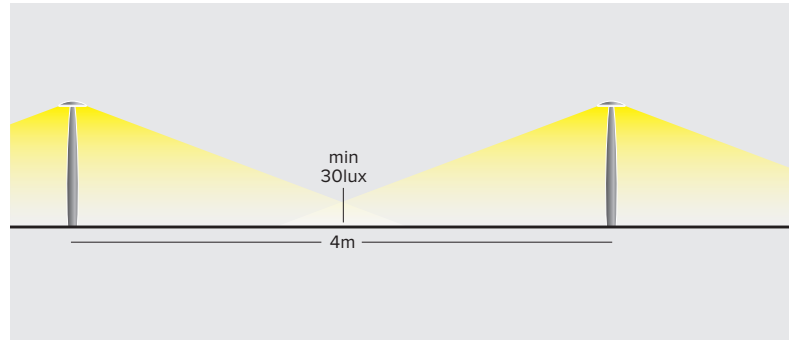

With an interval of three metres

between one fixtures and the next, the light never drops below 70lux to assure a perfectly uniform effect. With an interval of four metres between one fixtures and the next, the light never drops below 30lux.

CHIODINO

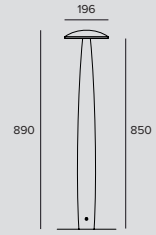

LED / 17W								
	3000K	H(m)	D(m)	Driver		Colour	3000K	4000K
	Ra84		66°	EL.			1E2967	1E2968
	Fixture Power	19W	1	2.70	210			
	Source Flux	2551lm	2	5.40	52			
	Fixture Flux	1310lm	3	8.11	23			
	Efficacy	68lm/W	4	10.81	13			
TS673	Imax=144cd/klm	Imax	367cd	5	13.51	8		

Accessories

Shutter

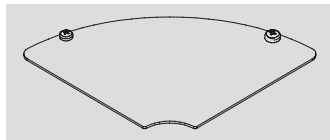

Code
1E2970

Shutter 90°.
Emission 2x90° or 270°

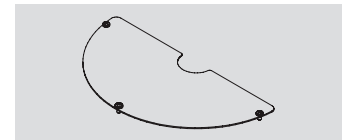

Code
1E2971

Shutter 180°.
Emission 180°

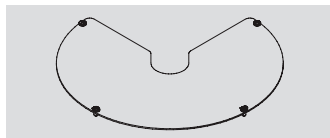

Code
1E2972

Shutter 270°.
Emission 90°

Mounting System

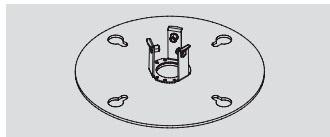

Code
1E2969

Plate for surface installation.
Powder coated ferrite finish 316L grade stainless steel. Compatible with 10mm up to 23mm fixing rods.

Tool

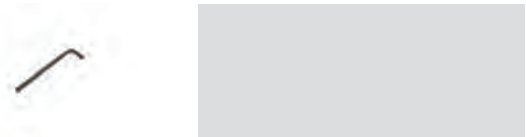

Code
1E2495

Features TORX HEAD, TX 30.

Connector

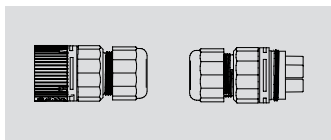

Code

1E2769

Connectors kit for 5 pole coaxial connections.



Code

1E2494

Non DALI looping connector.
1 IN - 3 OUT 4 poles max. wire section 2.5mm².
Cable diameter range from 8 to 12mm.
IP68

STILO

Bollard

GENERAL INFO

Direct or asymmetric emission bollard.
Raised Version H. 864mm
Path Version H. 800/1100mm

LED

Chip on board
From 1960lm to 4351lm
3000K – 4000K
Ra80 – Ra84

PRODUCT EFFICACY

Until 90lm/W

OPTICS

ASYM – FLOOR WASHER – WALL WASHER

POWER SUPPLY

Electronic

MATERIAL

Powder coated in ferrite finish anodized extruded aluminium body and die-cast aluminium optical unit. Transparent methacrylate protective screen or extra clear tempered safety glass.

A range of products with the same design but with different installation characteristics: from architectural lighting of building facades and porticos right up to pedestrian walkways. Different needs and effects with a unique family feeling; wall mounted versions, ceiling mounted and bollards that produce a myriad of lighting effects, from purely graphic and defined to wider beams that fill large spaces.

The Bollard version comes in two different types, Path and Raised.





Cantine Briziarelli

Photographer:
Antonino Ciddio



The bollard versions are available in two different types

The PATH version is ideal for lighting paths with its particular “size” that hides the optical system, shielding the source to obtain a well, distributed effect on pedestrian paths without the risk of glare.

The RAISED version is designed for architectural lighting and is available with different optical systems. A Floor Washer optic makes it possible to light horizontal surfaces in great depth to cover wide surfaces up to 6 metres; it is ideal to light parks, gardens and forecourts. There is also a Wall Washer optic that is ideal for lighting vertical surfaces in an extraordinary uniform way, such as facades, perimeter walls and vertical gardens.

STILO



Bollard Path H. 800mm

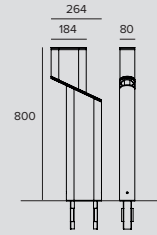

LED / 12W / ASYM □ 7 IP66 IP67 IK10

		3000K		H(m)		D1(m)		D2(m)		Emax(lx)	
		Ra84		93°		53°					
Fixture Power	14W	1	2.10	1.17	754						
Source Flux	1960lm	2	4.20	2.33	188						
Fixture Flux	1108lm	3	6.30	3.50	84						
Efficacy	82lm/W	4	8.40	4.66	47						
TS812	Imax=396cd/klm	Imax	776cd	5	10.50	5.83	30				

Driver	Colour	3000K	4000K
EL.	●	1E2863	1E2864



Bollard Path H. 1100mm

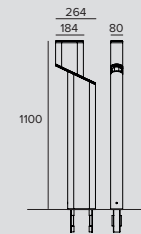

LED / 21W / ASYM □ 8 IP66 IP67 IK10

		3000K		H(m)		D1(m)		D2(m)		Emax(lx)	
		Ra84		93°		53°					
Fixture Power	23W	1	2.10	1.17	1225						
Source Flux	3187lm	2	4.20	2.33	306						
Fixture Flux	1802lm	3	6.30	3.50	136						
Efficacy	78lm/W	4	8.40	4.66	77						
TS812	Imax=396cd/klm	Imax	1261cd	5	10.50	5.83	49				

Driver	Colour	3000K	4000K
EL.	●	1E2861	1E2862

Accessories

Mounting System

Colour	Code
●	1E2564

Plate for surface installation.

Tool

Code
1E3185

T20 Torx insert.



Bollard Raised

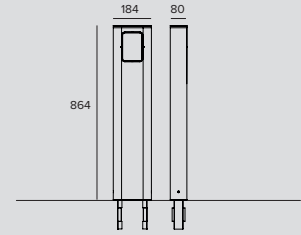

LED / 21W / FLOOR WASHER □ 7 IP66 IP67 IK09

	3000K	Driver	Colour	3000K	4000K	
	Ra84	EL.	●	1E2539		
	Fixture Power	23W	EL.	●	1E2540	1E2865
	Source Flux	3098lm				
	Fixture Flux	1403lm				
	Efficacy	61lm/W				

TS836 I_{max}=363cd/klm I_{max} 1125cd

LED / 33W / WALL WASHER □ 7 IP66 IP67 IK09

	3000K	Driver	Colour	3000K	4000K	
	Ra84	EL.	●	1E2541		
	Fixture Power	36W	EL.	●	1E2542	1E2866
	Source Flux	4244lm				
	Fixture Flux	3122lm				
	Efficacy	87lm/W				

TS813 I_{max}=661cd/klm I_{max} 2807cd

Accessories

Filter

Filter	Code
Red	1E3040
Green	1E3041
Blue	1E3042
Yellow	1E3043
Magenta	1E3044

Chromatic coloured PMMA filter, anodised powder coated frame (ferrite).

Mounting System

Colour	Code
●	1E2564
●	1E2563

Plate for surface installation.

Tool

Code
1E3185

T20 Torx insert.

ZEDGE

Bollard

GENERAL INFO

Pathlight bollard
64x64mm H.400mm

LED

Linear boards
From 570lm to 598lm
3000K – 4000K
Ra84

PRODUCT EFFICACY

Until 9lm/W

OPTICS

Floor washer

POWER SUPPLY

24Vdc

MATERIAL

The body of the fixture are made of powder coated die-cast anodised aluminium.

The Zedge range designed in collaboration with the firm Gensler to light passage ways.

Compact bollard step marker suitable for illuminating small path areas.

The floor washer optic allows to deeply illuminate with the maximum visual comfort.

Thanks to special accessories, the PRO version is available in a bollard model as well, for a high-performance solution, able to be suitable for your different needs.







BOLLARD

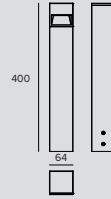

LED / 4W

	3000K	H(m) D1(m) D2(m) Emax(lx)					
		55°		86°			
Ra84							
Fixture Power	5W	1	2.62	2.11	23		
Source Flux	570lm	2	5.25	4.22	6		
Fixture Flux	40lm	3	7.87	6.33	3		
Efficacy	7lm/W	4	10.50	8.44	1		
TS1177	Imax=53cd/klm	Imax	30cd	5	13.12	10.55	1

Power supply	Colour	2700K	3000K	3500K	4000K
24Vdc		1E3736	1E3737	1E3738	1E3739

Related codes

Mounting System

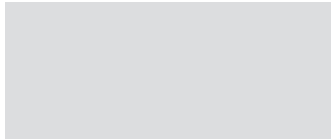

Code

1E3740

Plate with fixing rods for installation in concrete.

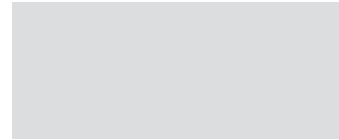

Code

1E3741

Plate for surface installation.

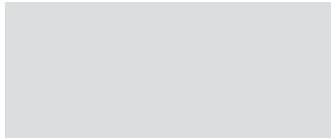

Code

1E3450

Fixing rods for installation in concrete.
AISI 316 stainless steel.
For Bollard installation.

Power Supply

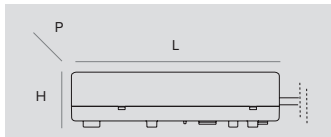

Code

1E3179

Electronic power supply 10W, LxHxP=79x24.5x38mm, 220/240V-AC, 24V-DC, IP67.

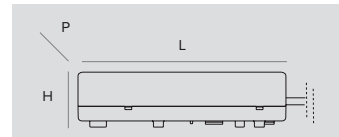

Code

1T3586

Electronic power supply 75W, LxHxP=130x32x80mm, 220-240V, 24V-DC, IP67.

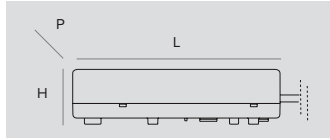

Code

1T3587

Electronic power supply 100W, LxHxP=230x87x43mm, 220-240V, 24V-DC, IP67.

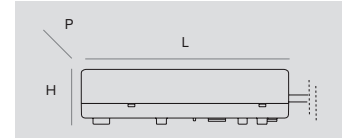

Code

1T3588

Electronic power supply 200W, LxHxP=238x42x67mm, 220-240V, 24V-DC, IP67.



Code

1E0993

Electronic power supply max 20W, Ø98 h78, 220/240V-AC, 24V-DC, IP68.
For Led.Y Multiled: up to 16 LED.Y connected in parallel.

Accessories

Connector

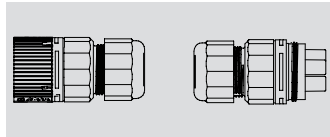

Code

1E2769

Connectors kit for 5 pole coaxial connections.
Remote mounting for the following products: Jupiter, Jupiter Mini, Saturn, Saturn Mini, and Led.Y.



Code

1E2494

Non DALI looping connector.
1 IN - 3 OUT 4 poles max. wire section 2.5mm².
Cable diameter range from 8 to 12mm.
IP68

Control systems

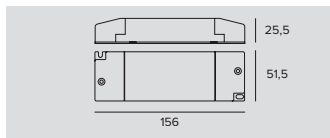

Code

1T6581

DALI/1-10V dimmer 12/24V.



Code

1E3048

A IP67 Module for individual control of external devices equipped with DALI drivers.
The module needs to be positioned in order to receive radio signals.
The distance to the lighting fixtures can reach up to 50m.



Code

1E3049

IP67 Extender for wireless control of DALI fixtures.
It generates a local DALI bus with the capacity to drive up to 64 fixtures.
Can control DALI fixtures in outdoor applications.

Control system

Control system



476
CONTROL
SYSTEM



488
PROGRAMMING
SYSTEM



488
LMS

CONTROL SYSTEMS

DYNAMIC LIGHT SOLUTIONS

FOR ARCHITECTURAL APPLICATIONS

LED with the best colour rendering and efficiency available on the market are the sources used for fixtures. By using these fixtures installation providing high emotional value can be created and, at the same time, the operative cost savings and eco-sustainability made available by LEDs are exploited.

To change the light colour a colour mixing system is used, this technique exploits the advantageous properties of LED lamps to generate enhanced colour saturation.

Targetti dynamic light fixtures are made using different kinds of technology:

- RGB: for typical dynamic coloured light applications;
- RGBW: with which it is possible to also have high quality white light;
- Tunable White: that produces a high quality white light with colour temperatures from 2700K to 5700K.

FIXTURE POWER SUPPLY

LED RGB and RGBW fixtures need special power supplies with PWM (Pulse Width Modulation) technology that makes it possible to regulate the light intensity separately of primary colours.

In larger RGB and RGBW products the electronic power supply is always combined with the one used for dynamic control (DMX); in this case the fixtures are self-sufficient and defined as "smart"; smaller fixtures on the other hand require an external device called a SECS BOX that can power and control several fixtures at the same time.

RGB fixtures and drivers are compatible with the DMX control protocol and are fitted with a dip-switch for address programming and operating modes. RGBW fixtures are compatible with the

DMX – RDM protocol that allows for remote programming via the data line.

AUTOMATIC OPERATION

To programme colour-changing light scenarios an external device is usually needed.

Thanks to the "Easy-Run-Menu" function the so called "intelligent" RGB fixtures and the SECS drivers can operate automatically performing dynamic colour sequences without any external controller. Through internal dip-switches it is possible to select among 16 different chromatic sequences:

- 8 static colour scenarios
- 8 dynamic colour sequences
- 5 different playback speed values (30sec, 80sec, 160sec, 320sec, 740sec).

MASTER/SLAVE" - CONFIGURATION

RGB Fixtures can be configured in a master/slave configuration where a virtually unlimited number of fixtures is controlled by a main one. In case of "non intelligent" fixture the master/slave configuration is achieved through a SECS BOX.

EXTERNAL CONTROL THROUGH

DMX 512 - PROTOCOL

For control and programming RGBW uses the standard DMX512 protocol, the most popular and well-tested protocol for intelligent lighting control. This feature provides a total compatibility with similar devices available on the market and a great variety of accessories at a reasonable cost.

DYNAMIC LIGHTING CONTROL

RGB and RGBW lines include digital devices for dynamic lighting control through DMX protocol. These devices are characterized by very intuitive user interfaces and by a very simple software.

My Scenario is suitable for the most different architectural applications, from the most simple to the most complex one.

SECS 75/36



Power supply and Control System SECS Scene Effect Control System

SECS 75 and SECS 36 drivers combine, in a single unit, the following 3 functions: power supply of RGB LED devices, playback of pre-set colour sequences and DMX interface for external control devices. The SECS "Easy-Run-Menu" function allows to playback of colour-changing light scenarios that are pre-stored into the driver, without the use of any external driver:

- 8 static colour scenarios;
- 8 dynamic colour sequences;
- 5 different playback speed values;
- Start/Stop of the selected scenario through a remote switch.

SECS 75 and SECS 36 drivers can also be controlled through DMX 512; in this case:

- DMX address (from 1 to 511) can be configured by using dip-switches;
- 3 channels mode: all R-G-B outputs are controlled simultaneously by 3 DMX channels only;
- 6 channels mode: the outputs are divided in 2 R-G-B groups, each one controlled by 3 different DMX channels;
- DMX line termination: SECS drivers contain a 120Ohm resistance which can be activated using a dip-switch;
- a DMX output is available for connection to other DMX devices.

SECS 75/36

SECS 75

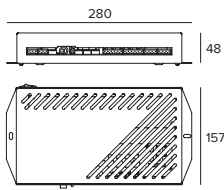

75W output

1T1827

SECS 75

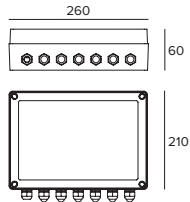

75W output

1E1401

TECHNICAL FEATURES

- Power supply: 100-240 VAC, 50-60 Hz with automatic adjustment and short circuit protection
- Max. output power: 75W
- Output voltage: maximum 24 VDC
- Driving current can be selected using dip-switches: 350 mA (for 1W leds) or 700 mA (for 3W leds)
- Controllable led devices: RGB led with common anode (+24 VDC, 4 wires) and power RGB led (1-3W, 6 wires)
- Led control mode: Pulse Width Modulation (PWM)
- Number of devices controlled: proportional to the wattage absorbed by the devices
- Resolution: 8 bytes with 256 levels equal to 16.770 million colours
- Digital interface: RS485 with opto-isolator and integrated buffer, compatible with USITT DMX 512 (1990) protocol
- Input: socket for DMX signal, over-voltage protection
- Outputs (modular terminal boards) that can be used simultaneously:
 - 2 outputs for constant voltage led devices
 - 2 outputs for constant current
 - 1 DMX output (over-voltage protection)
- Operating configuration: through dip-switches
- Internal diagnostics: led signalling correct or erroneous DMX connection,
- Firmware updates: by PC using DMX input
- Operating temperature: -20° +50°C.

SECS 36



35W output

1T2245

TECHNICAL FEATURES

- Power supply: 90-240 VAC, 50-60 Hz with automatic adjustment and short circuit protection
- Max. output power: 35W
- Power factor 0.9 (PFC)
- Led control mode: Pulse Width Modulation (PWM)
- Output voltage: maximum 30 VDC, SELV
- Driving current 350 mA
- Controllable devices: power RGB led (1-3W, 6 wires)
- Number of devices controlled: 9 LED for colour max
- Resolution: 8 bytes with 256 levels equal to 16.770 million colours
- Digital interface: RS485 with opto-isolator and integrated buffer, compatible with USITT DMX 512 (1990) protocol
- Input: socket for DMX signal, over-voltage protection
- Outputs:
 - 2 outputs for constant current LED devices
 - 1 DMX output with over-voltage protection
- Operating configuration: through dip-switches
- Internal diagnostics: led signalling correct or erratic DMX connection
- Operating temperature: -20° +50°C
- External control through DMX512 protocol.

OPTOSPLITTER

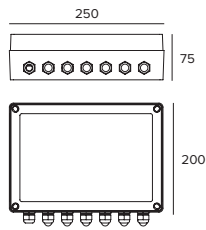

Device that has to be used for splitting a DMX 512 line to create up to four new branches, each fully optoisolated from the others. Optical isolation of each line increases transmission reliability, since it eliminates any possibility of ground looping. OptoSplitter 4ch also amplifies the DMX signals in output; this permits extending the transmission length to the maximum recommended by the DMX standards; each of the new DMX lines may be used as an independent line and each can handle up to 32 devices (not buffered). The fixture is not RDM compatible.

4 ch

1T2266

ELECTRICAL AND TECHNICAL FEATURES

- Power supply: 100-240 V AC, 50-60 Hz input (built-in)
- Power consumption: 5W
- Main switch for switching the device ON/OFF
- Input: 1 input for DMX 512 - USITT 1990 signal
- Outputs: 4 optoisolated, amplified DMX 512 outputs (3 kV)
- 1 amplified output for daisy-chain connection
- Connectors: modular terminal blocks inside the housing
- DIP switch: for inserting terminal resistor at end DMX line
- Protection classification: IP66
- Housing: Plastic material with input and output cable glands
- Complete with 1,5-meter power cord
- Ambient temperature for operation: -20°C to +50°C
- Dimensions: 250 x 200 x 75 mm.

FEEDING CABLE

6-pole cable for driver output connection to Constant Current LEDs	1E1713
Multifunction cable for outdoor use (DMX + power supply)	1E1715
Standard DMX cable (1 twisted pair + shield, 120Ohm)	1T1932

SCHEMA TIPICO DI COLLEGAMENTO / TYPICAL WIRING LAYOUT

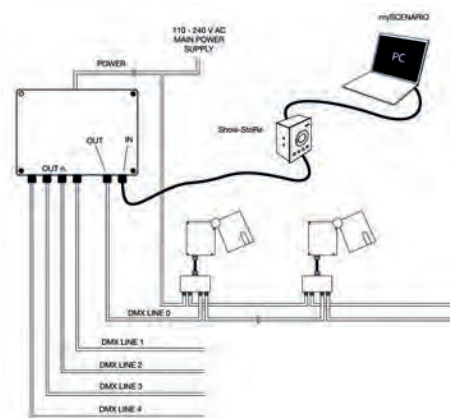

DMX 512 WIRELESS TECHNOLOGY

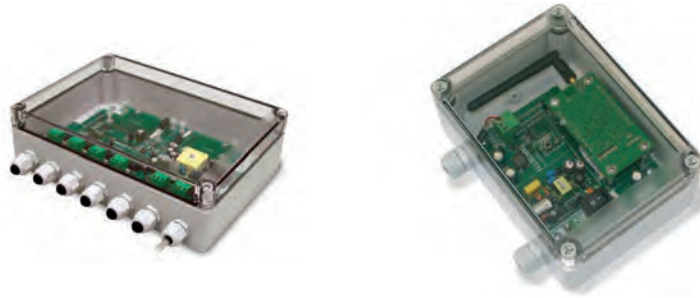

DMX Wireless technology can be transmitted the control signal to the lighting fixtures, without cables. Transmission is handled by a radio transmitter operating on a reserved frequency that is license-free worldwide.

It is able to transmit a signal:

- from one building to another;
- from a central control room to multiple installations in different positions, distant the ones from the others;
- from the inside of a building to the exterior, the facade, the roof, or a surrounding;
- in archaeological contexts in which digging trenches for laying.

A "DMX 512 Wireless" system requires that the control unit be equipped with a radio transmitter (external or built-in) and that a radio receiver is available in proximity to each DMX device or group of fixtures.

The product range includes a series of devices/fixture incorporating DMX 512 wireless technology, having the following characteristics in common:

- the signal is transmitted via radio, using a protocol and components derived from the GSM mobile telephony standard;
- the frequency used is FCC approved and is license-free throughout the world, including Japan and the USA;
- the devices apply FHSS (Frequency Hopping Spread Spectrum) technology;
- installation is the "plug-and-play" type; that is, there is no need to attribute IP addresses to the fixtures, which automatically recognize the transmitter by which they are controlled;
- the radio signal can be transmitted in a range up to 500 meters (1700 feet) in free space and through material such as walls, glass, and metals;
- multiple transmitters may be used in the same area because they can be individually to control a single group of fixtures without creating reciprocal interference;
- the fixtures are not RDM compatible.

WIRELESS OPTOSPLITTER

IP65

A device that operates as a radio receiver with up to 4 wired DMX lines in output.

4 ch with Wireless receiver **1E1906**

TECHNICAL FEATURES

Technical feature of this unit are identical to the ones of the normal Optosplitter with the following additional features:

- Built-in radio receiver module
- Built-in antenna
- RLS (Radio Link Status) monitoring system and LOG command (for transmitter linkage)
- Built-in power supply for all components, including radio section
- Protection grade: IP65
- Not RDM compatible

WIRELESS DMX - TRANSMITTER

0,2 IP65

This device receives a DMX-IN signal via cable. It can be installed at any point in a DMX line and from that point on it transmits the signal via radio. For example, connecting the device directly to the output of any DMX512 controller transforms it into a wireless controller. Not RDM compatible.

Transm. with 1 DMX input **1E1929**

TECHNICAL FEATURES

- Built-in radio module transmitting on the 2.45 GHz license-free radio frequency
- One radio output with external antenna
- Capability to control a DMX universe and to address individually 512 radio receivers
- RLS (Radio Link Status) LED system for monitoring quality of DMX transmission
- LOG key for secure receiver linkage
- Transmission range: 500 meters in open air
- Built-in power supply: 90-250V AC, 50/60 Hz
- Housing in plastic material, for outdoor use (IP65)
- Dimensions: 175 x 125 x 76 mm.

mySCENARIO

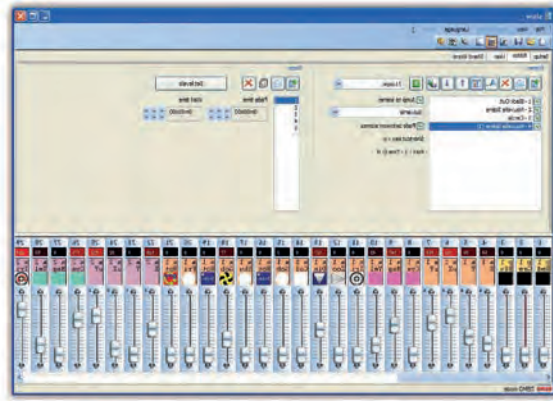

Systems of digital devices designed to control dynamic lighting fixtures and to programme dynamic light scenarios and sequences.

The system consists of an intuitive software, compatible with Windows operating systems, able to control different hardware devices having the following functions:

- recording colour-changing scenarios set by the operator;
- allowing the selection among the multiple scenarios recorded;
- transmitting the control signals to the lighting system.

The software is interfaced to the PC through a USB port; the interface with lighting fixtures is featured through a DMX 512 output.

The software provides a graphic simulation of the operating keys of lighting controller; the patching function allows to assign the DMX control channels to the fixtures by using the

internal library.

The Colour Manager function allows a quick and intuitive programming of a RGB light show, consisting of several steps with assigned duration and fading times. The built-in calendar allows a full time scheduling of show playback (month, day, hour, minutes, recurring events). The programmed light shows can be transferred to the different control interfaces.

mySCENARIO SHOW STORE

Software + USB interface **1T1898**

INTERFACE TECHNICAL FEATURES

- Storage, via USB, of light-shows created through mySCENARIO software
- Automatic stand-alone operation with non need of a PC or any other external driver
- Keys for scrolling through programmed sequences
- Digital display to show the number (1-99) of active scene
- Led indicators for ON/OFF status
- Three poles XLR output – DMX signal to lighting fixtures
- XLR input for daisy chain connection to other identical unit
- Management of 512 DMX channels (512 parameters to be programmed separately)
- Memory dedicated to light shows proportional to number of connected channels (2877 with 20 channels; 2877 with 60 channels; 355 with 512 channels);
- Internal clock for sequences triggering
- External power supply 100-240 VAC, 50-60 Hz in case of use without PC.



TYPICAL WIRING LAYOUT

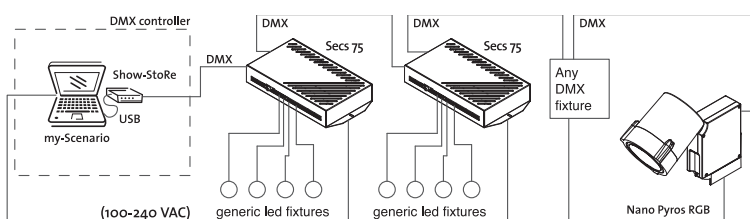

mySCENARIO WALL



DMX controller with a glass touch sensitive screen for architectural applications.

It can manage 10 different lighting zones and 50 scenarios per zone.

It can control two different DMX universes (2x 512 channels).

The touch keys on the front make it possible to modify and recall programmed scenarios.

Stand alone function or connected to a computer using a USB port.

Power supply adapter and USB cable included.

Software for creating scenarios (that can be downloaded from the Targetti website) is included.

To be used with all RGB and RGBW products.

mySCENARIO WALL

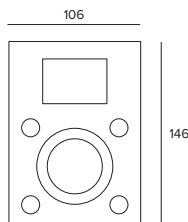

1T6499

INTEFACE TECHNICAL FEATURES

- 6 Vdc power supply
- 4W output
- SD memory card
- DMX 2x 512 channels
- Windows 32/64 bit operating system
- Dimensions 146 x 106 x 11 mm

USB-RDM PROGRAMMER CODE

DMX-RDM (Remote Device Management) address planner.

Used with the "RDM Targetti" software that can be downloaded for free from the Targetti website download section.

To be used with all RGBW products.



USB -RDM

1E2767

CASAMBI - LIGHTING MANAGEMENT SYSTEM

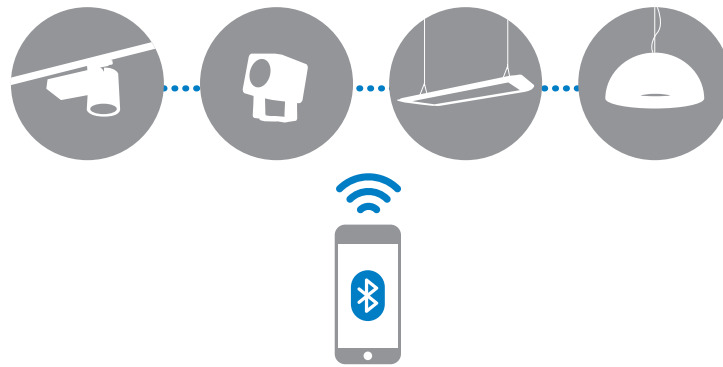

LMS is the Targetti wireless home automation system that can manage even the most complex lighting systems. Designed for the consumer and the professional market, LMS is the result of the combination of components from Casambi - a leading company producing wireless lighting control solutions - and Targetti light fixtures.

iOS AND ANDROID APPS

Thanks to the intuitive simplicity of the app developed by Casambi for iOS and Android, LMS ensures system operational readiness. You just need a phone or another mobile device and anyone can create and manage a lighting network singlehandedly by controlling every fixture individually or in groups depending on the needs and the functions required. Managing the system using a standard handset is also made possible with the use of specific accessories.

EXTREME USABILITY

The ease of use and programming of the system makes it easy to manage without the use of special control units or assistance from

specialised technicians. The application recognises and associates the Targetti fixtures that are installed in the space automatically by using the BLE (Casambi Bluetooth Low Energy) proprietary protocol to communicate with the various fixtures. No Internet connection is necessary except for synchronisation functions or remote access.

MESH SELF-HEALING NETWORK

LMS allows the final user to generate adaptive and multipoint networks: "adaptive" because every fixture can work as a buffer for all the others, adapting automatically to various contexts to optimise control signal propagation; "multipoint" because you can connect up to 127 fixtures on each network without any limit on the number of networks. The result is strong, reliable and affordable networks that manage the system, the profiles of individual fixtures and access rights.



1. Choose Targetti fixtures by opting for the Targetti Casambi Ready package or Casambi accessory components.



2. Install the fixtures without running more cables.



3. Download the Casambi iOS or Android App depending on the device used.



4. Activate the Bluetooth function on the device.



5. Turn on the installed fixtures.



6. Launch the App: the fixtures in operation will be detected automatically.



7. Create one or two networks depending on the characteristics of the environment.



8. Create groups of devices as needed.



9. Program scenes and/or sequences.



10. Set the level of network sharing by choosing one of the following possibilities:
 - a. No network sharing
 - b. Sharing with administrators only: access with an admin password
 - c. Sharing with visitors: the password in this case does not permit network programming
 - d. Open access without programming possibilities.Synchronisation between the different fixtures is ensured by the Cloud function.

WORK BETTER WITH LMS

For optimum system operation we recommend you follow the sequence of steps given below.

LIGHTING MANAGEMENT SYSTEM

LMS FUNCTIONS

Here is a list of the various functions of the system that can vary depending on the characteristics of the product and the degree of complexity of the system.

1. Create a network.

2. On/Off of the fixtures: touch the icon relating to the fixture once or twice.

3. Dimming: scroll to the right to increase the light intensity and to the left to reduce it.

4. Colour temperature control: scroll up or down for getting respectively warmer or colder colour temperatures.

5. Colour control: touch and hold the icon of the device to see the colour-options.

6. Create groups.



7. Function Gallery: capture/upload a photo or a render of the space to manage the device directly on the image.

8. Configure lighting scenes.

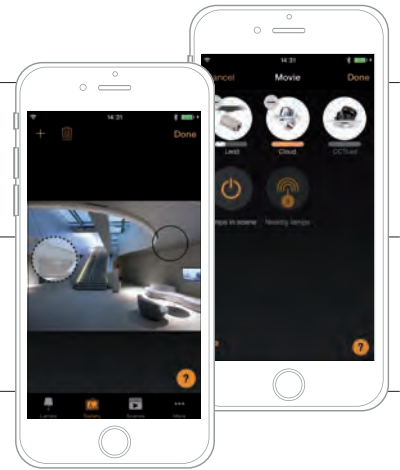

9. Configure sequences (dynamic scenes or sequences of different scenes).

10. Timer Function: set fade times between scenes and sequences and programme date and duration.



11. Geolocation: by activating this tool it is possible to programme on and off functions that can be automatically associated to sunrise and sunset irrespective of the period of the year (astronomical watch).

12. Cloud Function: makes it possible to share different devices and remote access to the network. In remote access a device acts as a gateway while the others are connected via the Cloud.

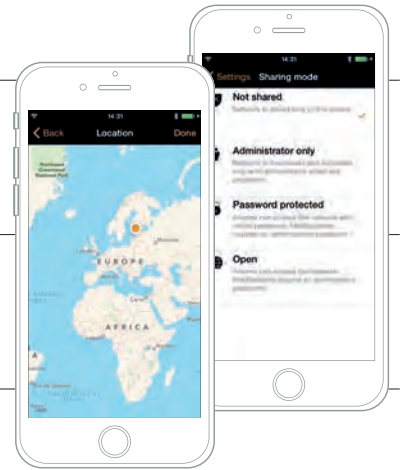

13. iBeacon technology (only for iOS): fixtures equipped with LMS modules are equipped to interact with iBeacon technology based retail or museum applications.



LIGHTING MANAGEMENT SYSTEM

CASAMBI ACCESSORIES

External accessories with simple electric cables make it possible to control Targetti fixtures in wireless mode.

For a clear and easy choice for the correct accessories, please refer to the explanatory table on page 794 that shows:

- An alphabetical list of the Targetti fixtures that are compatible with Casambi accessories
- Product variants that are compatible with Casambi accessories (only some variants of the same product can be controlled by the LMS system)
- Compatible accessories (descriptions and technical characteristics are listed below)
- Wiring diagram (the complete list is available on page 800)

Gateway DALI/Casambi available that allows fixtures fitted with mesh Bluetooth Casambi technology to interface with a traditional DALI system and to be adjusted by a DALI control unit. For further information see the website.

Control module IP20



A wireless control module with a DALI interface. It generates a local DALI bus which makes it possible to connect a LED driver directly to a DALI interface. The module can only be used in a closed system and cannot be connected to an existing DALI network. The module is wireless controlled using a CASAMBI app for smartphones and tablets using Bluetooth 4.0 technology. The devices create an adaptive, secure and reliable wireless mesh network that can control a large number of fixtures in a simple and efficient way. IP20.

	1T5349
Power supply	220-240 VAC
Power	1,1W - PF 0,6
Max current	0,6 Amp AC
Max n. DALI driver	1
Max n. 1-10v driver	1
Dimensions	37x41x14 mm
Exit	

Dimmer wireless Bluetooth



Wireless Bluetooth Dimmer capable of handling constant voltage loads of 12V or 24V subdivided into 4 channels with PWM output. This dimmer must be connected between the 12V or 24V power supply and the constant voltage LED module. The maximum total current that can be supplied by the control unit is 6A (equivalent to a total of 144W) that can be divided between the 4 outputs. Compatible with Minimercurie RGB and Micromercurie

	1T7944
Power supply	12/24 VDC
Power	144W (24V)
Max current	72W (12V)
Max n. DALI driver	
Max n. 1-10v driver	
Dimensions	72,6x18x30mm
Exit	PWM

Xpress



1T5350

Xpress is a wall mounted wireless user interface; it can be installed wherever the user chooses thanks to battery power with autonomy of 2-3 years providing direct access to all the most important CASAMBI system control functions. As well as switching the fixtures on and off, Xpress controls dimming, colour temperature change in fixtures equipped with this technology, and control of individual fixtures and lighting scene or sequence management.



Trailing Edge dimmer IP20



1T5351

A Wireless Trailing Edge / IGBT dimmer managed using Bluetooth 4.0 technology. It works with LED 230 V-AC modules, dimmable LED sources and halogen lamps. It can be installed inside a standard 503 wall switch box, lighting fixtures or ceiling canopies. It can manage systems with a maximum absorption of 150W. The module is wireless controlled using a CASAMBI app for smartphones and tablets or traditional wall switches. IP20.

Power supply	85-240 VAC
Power	0,3W - PF 0,35
PMax power fixtures*	
Dimensions	37x41x14 mm

*Consult the assembly instructions.

Extender IP20



1T5352

Extender IP20 allows for wireless control with a DALI interface. It generates a local DALI bus with the capacity to drive up to 64 fixtures and can control groups of fixtures in indoor applications. It is also equipped with a relay that can control non-dimmable fixtures up to a maximum of 6A. It prevents any change to the management features provided by the CASAMBI system.

Power supply	100-240 VAC
Power	2,7W - PF 0,6
Max current	6 Amp AC
Max n. DALI driver	64
Max n. 1-10v driver	30
Dimensions	100x42x30 mm

Control module IP67



1E3048

A IP67 Module for individual control of external devices equipped with DALI drivers. The module needs to be positioned in order to receive radio signals. The distance to the lighting fixtures can reach up to 50m.

Power supply	220-240 VAC
Power	1,1W - PF 0,6
Max current	0,6 Amp AC
Max n. DALI driver	1
Max n. 1-10v driver	1
Dimensions	120x65x30 mm

Extender IP67



1E3049

A IP67 Extender allows for wireless control with DALI interfaces. It generates a local DALI bus with the capacity to drive up to 64 fixtures and can control groups of fixtures in outdoor applications. It prevents any change to the management features provided by the CASAMBI system.

Power supply	100-240 VAC
Power	2,7W - PF 0,6
Max current	6 Amp AC
Max n. DALI driver	64
Max n. 1-10v driver	30
Dimensions	150x150x40 mm

LIGHTING MANAGEMENT SYSTEM

PRODUCT	VARIANT	1T5349	1T5351	1T5352	1E3048	1E3049	DIAGRAMS
		CONTROL MODULE IP20	TRAILING EDGE DIMMER IP20	EXTENDER IP20	CONTROL MODULE IP67	EXTENDER IP67	page 800/801
BEBOP RECESSED	DALI Version	●		●			01 - 04
BOTTONE	LED module 230Vac max 150W		●				03
BRAQUE	LED module 230Vac max 150W		●				03
	Rectangular suspension			●			04
CARTESIO	Square suspension DALI Version	●		●			01 - 04
	Square ceiling	●		●			01 - 04
CCT FLASH LED	DALI Version	●		●			01 - 04
CCTLED ARCHITECTURAL	DALI Version	●		●			01 - 04
CCTLED ARCHITECTURAL MICRO	DALI Version	●		●			01 - 04
CCTLED ARCHITECTURAL MINI	DALI Version	●		●			01 - 04
CCTLED DOWNLIGHT	DALI Version	●		●			01 - 04
CCTLED DOWNLIGHT MICRO	DALI Version	●		●			01 - 04
CCTLED DOWNLIGHT MINI	DALI Version	●		●			01 - 04
CCTLED PENDANT	DALI Version	●		●			01 - 04

ACCESSORIES



PRODUCT	VARIANT	1T5349	1T5351	1T5352	1E3048	1E3049	DIAGRAMS
		CONTROL MODULE IP20	TRAILING EDGE DIMMER IP20	EXTENDER IP20	CONTROL MODULE IP67	EXTENDER IP67	
CCTLED TUBE	DALI Version	●		●			01 - 04
CLOUD	DALI Version	●		●			01 - 04
CLOUD MINI	DALI Version	●		●			01 - 04
CORO	With DALI driver	●		●			01 - 04
COZY	With DALI driver	●		●			01 - 04
DART MAXI	DALI Version				●	●	05 - 06
DART MEDIUM	DALI Version				●	●	05 - 06
DART SMALL	With DALI driver				●	●	05 - 06
DIVA	DALI Version			●			04
FEBO EVO	DALI Version				●	●	05 - 06
FLOOD	DALI Version	●		●			01 - 04
FORTYEIGHT - LABEL 48V	DALI Version	●		●			01 - 04
FORTYEIGHT - LOGICO 30	DALI Version	●		●			01 - 04

LIGHTING MANAGEMENT SYSTEM

PRODUCT	VARIANT	1T5349	1T5351	1T5352	1E3048	1E3049	DIAGRAMS
		CONTROL MODULE IP20	TRAILING EDGE DIMMER IP20	EXTENDER IP20	CONTROL MODULE IP67	EXTENDER IP67	
GLOBO	Halogen max 150W		●				03
HALL	DALI Version	●		●			01 - 04
ISO		●		●			01 - 04
JEDI	DALI Version				●	●	05 - 06
JEDI INCASSO					●	●	05 - 06
JEDI COMPACT IP40	DALI Version	●		●			01 - 04
JEDI COMPACT IP67	DALI Version				●	●	05 - 06
JUPITER	With DALI controller				●	●	05 - 06
JUPITER PRO					●	●	05 - 06
LABEL 230V	DALI Version	●		●			01 - 04
LOGICO	DALI Version *For fixture with 1 driver	●		●			01 - 04
MONETA	LED module 230Vac max 150W		●				03
MR. BO	DALI Version				●	●	05 - 06



PRODUCT	VARIANT	1T5349	1T5351	1T5352	1E3048	1E3049	DIAGRAMS
		CONTROL MODULE IP20	TRAILING EDGE DIMMER IP20	EXTENDER IP20	CONTROL MODULE IP67	EXTENDER IP67	
MR. SMITH					●	●	05 - 06
MRS. SMITH					●	●	05 - 06
OMEGA		●		●			01 - 04
OSIRIDE LED	Version with LED module 230Vac max 150W		●				03
OZ STAND ALONE 230V		●		●			01 - 04
PANTHEON	LED module 230Vac max 150W		●				03
PROFESSIONAL LED	Version with LED module 230Vac max 150W		●				03
QUICKLED	DALI Version	●		●			01 - 04
SATURN	With DALI controller				●	●	05 - 06
STORE GIMBAL	DALI Version	●		●			01 - 04
STORE MINI GIMBAL	DALI Version	●		●			01 - 04
THREESIXTY	DALI Version *For fixture with 1 driver	●		●			01 - 04
VOLTA IP66	With DALI driver				●	●	05 - 06

LIGHTING MANAGEMENT SYSTEM



PRODUCT	VARIANT	1T5349	1T5351	1T5352	1E3048	1E3049	DIAGRAMS
		CONTROL MODULE IP20	TRAILING EDGE DIMMER IP20	EXTENDER IP20	CONTROL MODULE IP67	EXTENDER IP67	
WASABI	LED module 230Vac max 150W		●				03
ZEDGE	With DALI controller				●	●	05 - 06
ZEDGE LINE	DALI Version				●	●	05 - 06
ZEDGE PRO	DALI Version				●	●	05 - 06
ZENO APPLIQUE	DALI Version	●		●			01 - 04
ZENO SMALL	DALI Version	●		●			01 - 04

WIRING DIAGRAMS

01

Single DALI control IP20

1T5349

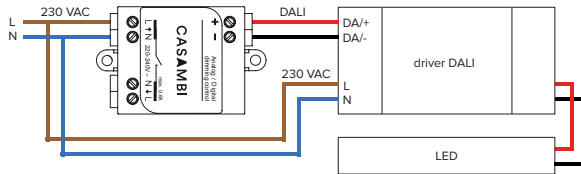

02

CASAMBI control, 1-4 channels IP20

1T7944

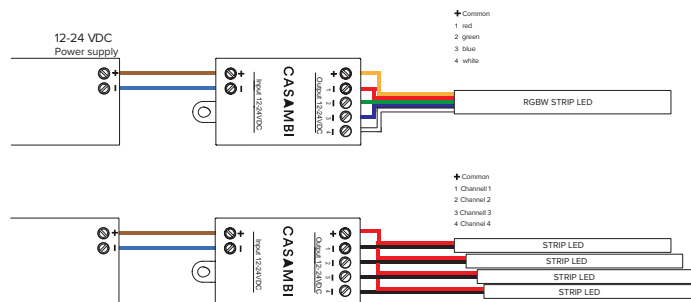

03

Single Trailing Edge control for LED 230 V-AC Modules, dimmable LED sources and halogen lamps - 12V and mains voltage (IP20)

1T5351

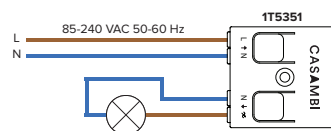

04

DALI multiple control IP20

1T5352

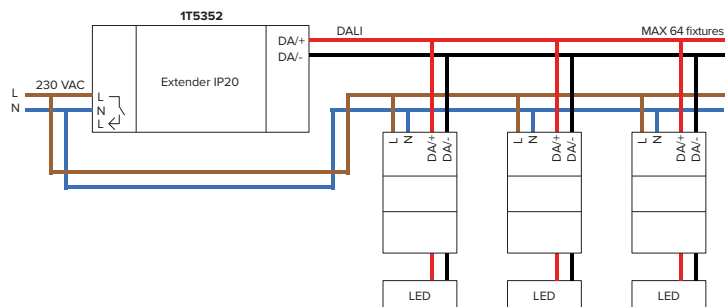

04

DALI multiple control with relay IP20

1T5352

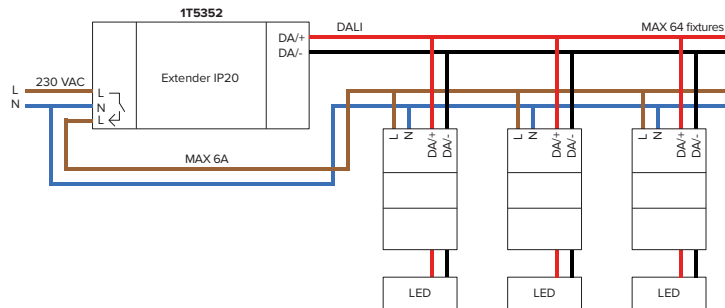

05

DALI single control IP67

1E3048

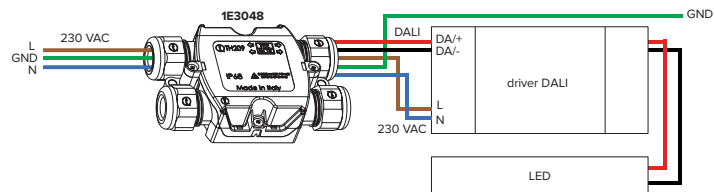

06

DALI multiple control IP67

1E3049

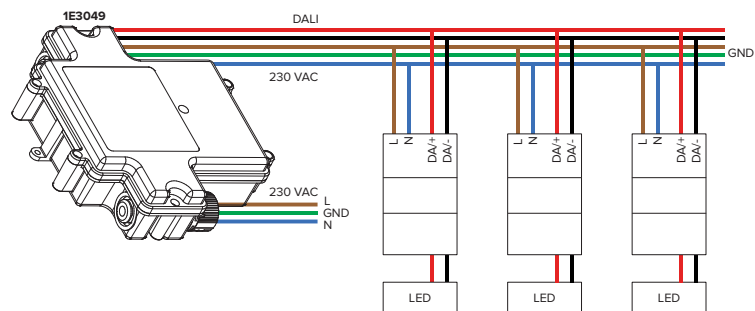

07

Diagram for use with wall mounted push button

normally closed

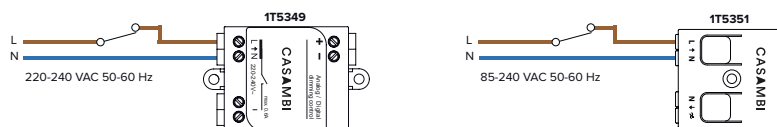

normally open

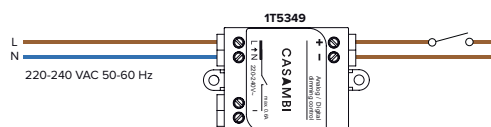

Technical data

POWER SUPPLY

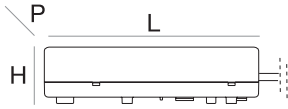

ELECTRONIC BALLAST/POWER SUPPLY FOR LED SOURCE

Power	LxHxP	Power supply	Output current	Output voltage	Dimming	Protection	
max 20W	Ø 98 H 78	220-240V		24V-DC		IP68	1E0993
17W	Ø 105 H 74	220-240V	700 mA				1E1385
12W	Ø 105 H 74	110-120V	700 mA				1E1385
70W	225x51x65	220-240V		48V-DC		IP67	1E2320
150W	225x51x65	220-240V		48V-DC		IP67	1E2321
480W	227x100x125	220-240V		48V-DC		IP20	1E2323
240W	125x100x125	220-240V		48V-DC		IP20	1E2533
max 43W	150x40x150	220-240V	600mA			IP68	1E2571
max 43W	150x40x148	220-240V	600mA		DALI	IP68	1E2572
max 50W	150x40x148	220-240V	900mA			IP68	1E2573
max 50W	150x40x148	220-240V	900mA		DALI	IP68	1E2574
20W	150x40x148	110-240V	400mA		1-10V	IP68	1E3033D
20W	150x40x148	110-240V	400mA		DALI	IP68	1E3033DA
20W	150x40x148	220-240V	400mA			IP68	1E3033EL
20W	150x40x148	110-240V	900mA		1-10V	IP68	1E3034D
20W	150x40x148	110-240V	700mA		DALI	IP68	1E3034DA
20W	150x40x148	110-240V	900mA			IP68	1E3034EL
10W	69x33x38	220-240V		24V-DC		IP67	1E3179
15W	119x22x52	220-240V	350mA			IP20	1T1757
29W	160x35x83	110-240V	700mA			IP20	1T2963
29W	160x35x83	110-240V	700mA		DALI	IP20	1T2965
max 50W	160x35x83	220-240V	900mA			IP20	1T2966
max 50W	160x35x83	110-240V	900mA		DALI	IP20	1T2968
75W	130x32x80	220-240V		24V-DC		IP67	1T3586
100W	230x87x43	220-240V		24V-DC		IP67	1T3587
200W	238x42x67	220-240V		24V-DC		IP67	1T3588
32W	160x35x83	110-240V	600mA			IP20	1T3625
32W	160x35x83	110-240V	600mA		DALI	IP20	1T3627
50W	185x22x63,5	220-240V		24V-DC		IP20	1T3726
42W	160x35x83	110-240V	1050mA			IP20	1T3781
42W	160x35x83	110-240V	1050mA		DALI	IP20	1T3783
max 22W	130x30x42	220-240V	500mA			IP20	1T3966
20W	118x22x52	110-240V	400mA		1-10V	IP20	1T4215D
20W	118x22x52	110-240V	400mA		DALI	IP20	1T4215DA
20W	118x22x52	220-240V	400mA			IP20	1T4215EL
max 15W	119x22x52	110-240V	350mA		DALI	IP20	1T4630
20W	119x22x52	220-240V	500mA		DALI	IP20	1T4631
15W	119x22x52	110-120V	500mA		DALI	IP20	1T4631
max 60W	129x30x76	220-240V	1050mA			IP20	1T4723
max 60W	129x30x76	220-240V	1050mA		DALI	IP20	1T4725
20W	118x22x52	110-240V	900mA		1-10V	IP20	1T5295D
20W	118x22x52	110-240V	700mA		DALI	IP20	1T5295DA
20W	118x22x52	110-240V	900mA			IP20	1T5295EL
12W	101,5x29,5x51	220-240V	350mA			IP20	1T6503
12W	67x103x21	220-240V	350mA		DALI	IP20	1T6504
12W	158x19x22	220-240V	350mA			IP20	1T6505
42W	129x30x42	220-240V	1050mA			IP20	1T6524
10W/20W	145x19x55	110-240V/220-240V		12V-DC		IP20	T1585
70W	225x51x65	220-240V		12V-DC		IP65	T1586

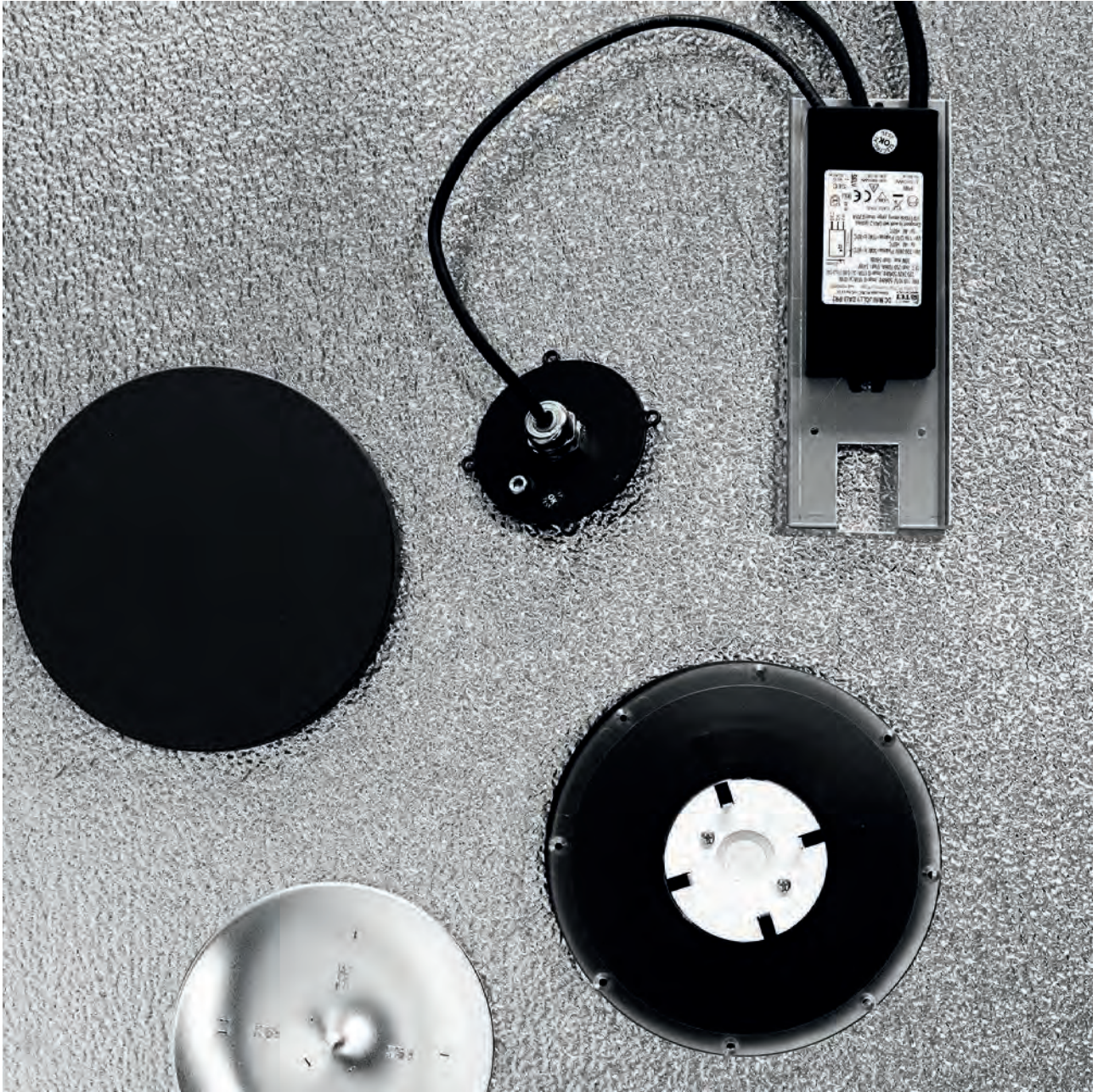

LED

CHARACTERISTICS OF THE LED LAMPS TARGETTI FIXTURES ARE FITTED WITH

Colour tolerance

The Targetti collection uses different LED lamps depending on the type of fixture. Nevertheless the hue of the light emitted is always the same from one fixture to another because only LED lamps produced by leading companies in the sector are used, with the same chromaticity identified by the methodology of MacAdam ellipse or SDCM (Standard Color Deviation Matching).

Light chromaticity is identified using a two-dimensional value within an ellipse that defines the maximum displacement of chromaticity from the point of reference (the centre of the ellipse).

A 3 SDCM value is generally considered the maximum value before an average observer perceives chromaticity differences.

The colour tolerance values used in Targetti are as follows:

1.5 SDCM (1 on request) for fixtures that use COB LED lamps

3 SDCM (2 on request) for fixtures that use LED COB High density and LED Mid-Power lamps

It is also important to consider colour tolerance throughout the life span lamps (long term color consistency). Targetti LED lamps ensure the declared colour tolerance for the entire life of all fixtures.

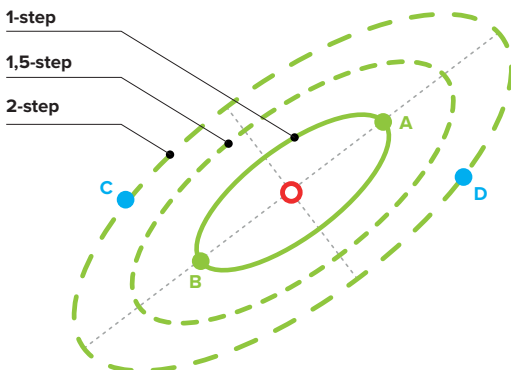
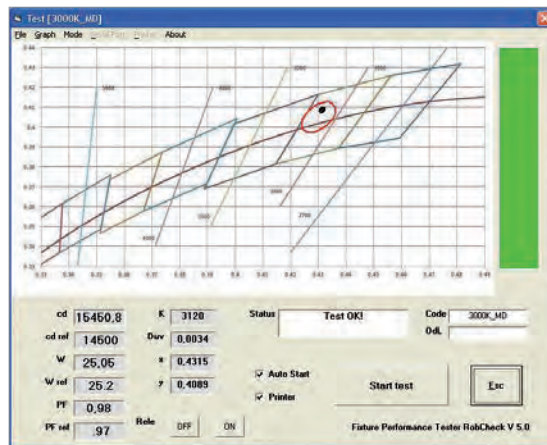
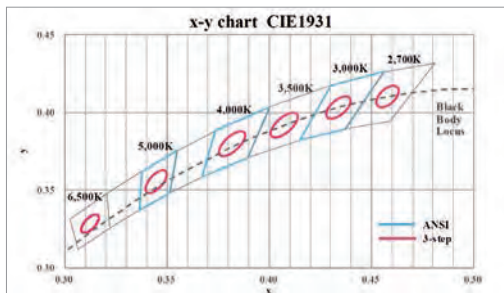
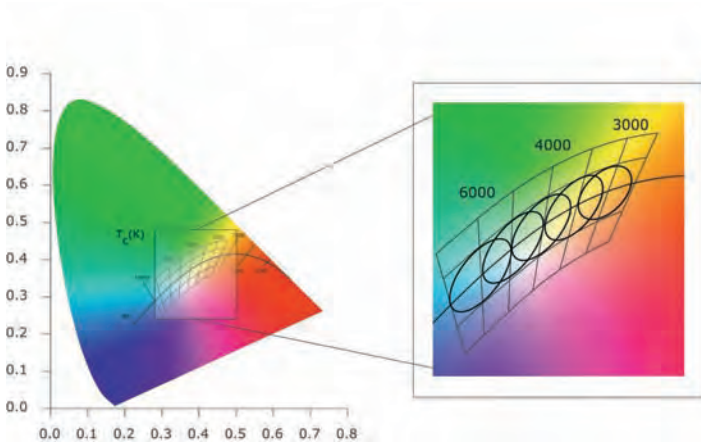

Colour rendering

The colour rendering index is the quantitative measure of the ability of a light source to reproduce colours faithfully . The method approved and currently used is the **CIE CRI (Color Rendering Index)** also known as **CIE Ra**. To determine it a comparison is carried out between the lamps to be evaluated and a reference light source with the same colour temperature.

It is based on a comparison of 15 “patches” of colour. The Ra index is the average of the 15 Patches, R9 is the rendering of the red patch.

A colour rendering index between 90 and 100 is considered excellent and a value between 80 and 90 is good. Among specialists in the field the CRI method is often contested given that it provides values that are sometimes inadequate especially for some LED sources.

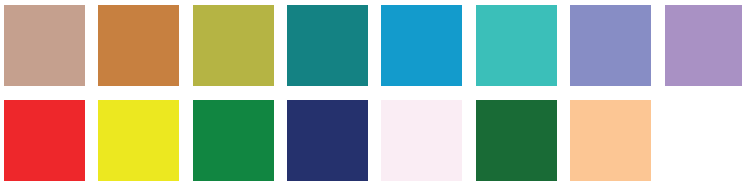

At meetings between the regulatory and standardisation committees various alternative methods have been put forward.

The one that is more popular and considered more reliable today is the **TM 30-15** method from the IES (Illuminating Engineering Society).

Most importantly is the IES TM-30-15 IES – the acronym for the Illuminating Engineering Society – the organisation that developed the scale as a new method for evaluating the colour rendering of a light source. It appears to be more reliable than the previous Ra because it is based on the colour rendering comparison of 99 “colour patches” rather than 8+6 like the CRI. In addition, where the CRI provides a single score, therefore it does not significantly express the narrow but broad relationship between light and colour, the TM-30 appears to be more complete because it is identified using three different parameters: an Rf Fidelity index, an Rg Gamut index and a colour vector graphic. These combine to provide a more accurate image of the colour fidelity of a light source and a better explanation of the exceptional colour rendering capabilities of LED sources.

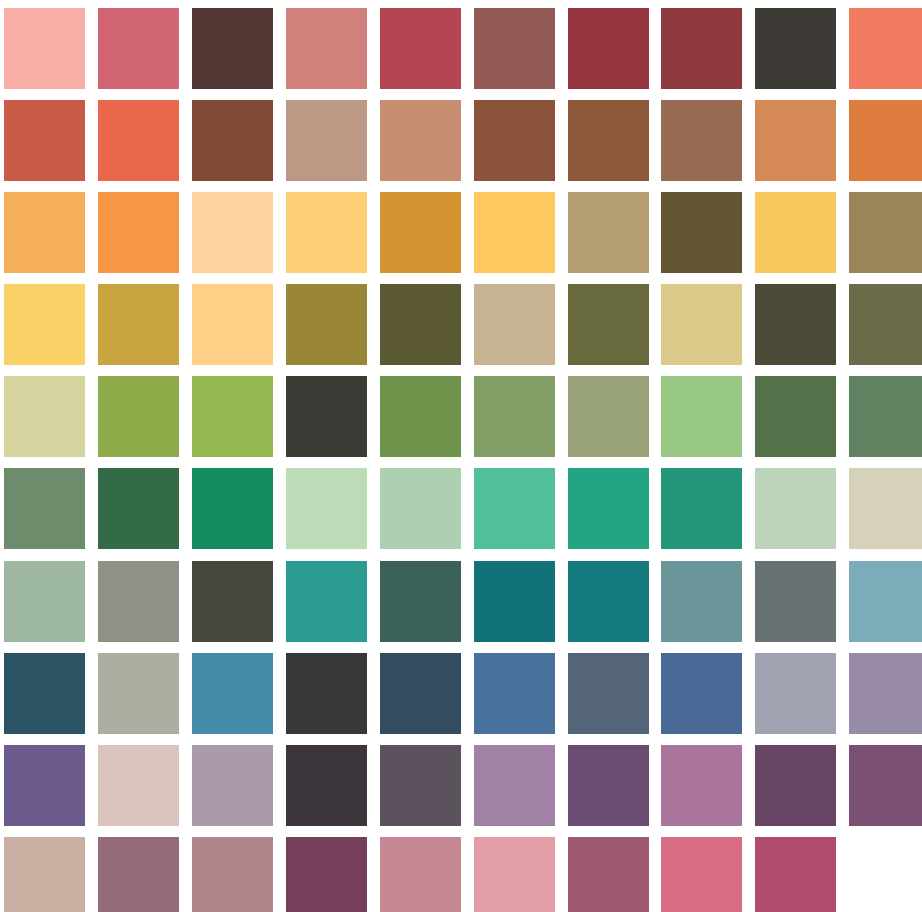

LED

Rf (Fidelity)

The TM-30 Fidelity index uses 99 colours, rather than 8+4 of the CRI, chosen from real world objects. Like the CRI the points of the Fidelity index go from 0 to 100. A score of less than 60 is too poor for indoor use and a 90+ score is ideal for an effect that is similar to daylight.

The TM-30, 99 "colour patches" are classified into seven groups (nature, skin tones, textiles, paints, plastics, printed material and colour systems). This categorisation helps because the light source can be tested on specific application areas.

Rg (Gamut)

Evaluates the intensity of colours under a certain light, therefore it provides indications of the source's ability to reproduce colour saturation (breadth of colour range).

A score range equal to 100 indicates that the light source does not change the hue or colour saturation that are reproduced in the same way as the sample source.

R>100 indicates an increase in colour saturation, therefore they appear more intense.

R<100 indicates a decrease in saturation.

TM-30 colour vector graphic

TM-30 colour vector graphic

Indicates which colours appear to be saturated and which desaturated.

In the TM-30 colour vector graphic the white circle represents the sample light, while the circle with the colored background is the light being tested. If the circles overlap perfectly the tested light corresponds to sunlight.

The areas that extend beyond the black circle indicate that the colours are more intense compared to the sample, however those that remain inside represent colours that appear desaturated.

Unlike the Fidelity and Gamut indexes which are numerical scores, the colour vector graphic is a visual representation that makes it possible to understand which colours are more and less intense.

This is particularly useful when it is necessary to highlight a particular colour, for example in retail applications.

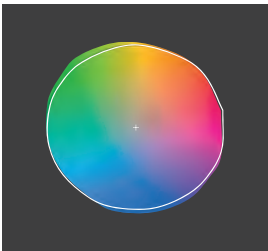

Life expectancy of LED sources and lumen maintenance

LED lamps emit light for an extremely long length of time with an almost insignificant failure rate.

The life expectancy of a LED lamp is based on the decreasing lumen rate and the percentage of fixtures are subject to this decrease in a certain period of time.

For example a LED source with a life expectancy of 80000 hours is identified with the code L80 B10 when lots of this type of source once they reach 80000 hours will have at least 90% (100% - B=10) of the LED with lumen of over 80% of the original (L=80).

The lifetime of LED lamps is measured using tests carried out according to the IES LM80 standard. A certain number of LED lamps are left working at different temperatures for at least 6000 hours. Every 1000 hours various parameters are measured: lumen, chromaticity, power etc. The results are then processed using the IES TM 21 procedure that makes it possible to extract the data and produce the lumen maintenance values in hours, L and B depending on the operating temperature.

Life span of LED fixtures

The life span of LED light fixtures depends mainly on two components: the LED lamp and the LED driver.

The life span of LED sources and LED drivers are heavily dependent on the temperature these components operate inside the fixture. Targetti fixtures are designed to have very low operating temperatures for LED sources and drivers compared to the limits indicated by producers to ensure excellent performance in terms of duration and lumen

maintenance.

Targetti fixture data

Since LED technology was applied to light fixtures we have always wanted to be completely transparent in publishing data relating to the performance of our fixtures.

For every fixture we have always indicated:

- The power of the LED source (Watt)
- The lumen of the LED source (lm)
- The power of the fixture (Watt)
- The lumen of the fixture (lm)
- Maximum intensity (cd)
- Typical colour rendering CIE Ra - TM30 Rf, Rg

Warnings on LED fixtures

Given the production process of LED lamps, typical values indicated by parameters only represent statistical magnitude. These values are affected by the manufacturing tolerances of producers of LED lamps, drivers (LED power feed) and also the operating temperature of the fixtures (LED voltage varies with temperature).

Targetti fixtures are designed, built and tested in compliance with current standard regulations and technical requirements. As required by regulation IEC 60598, technical checks are carried out at a room temperature of 25°C. Even lumen output and lighting data are based on a room temperature of 25°C. At different temperatures deviations from the values indicated in the catalogue are possible.

Manufacturing tolerance on data relating to declared output and performance is $\pm 10\%$

Then laboratory measurement uncertainties are then added:

Lumen 5%

Intensity 1%

Power 0.5%

Temperature 3%

PHOTOMETRIC DATA

Photometric measurements were taken at the "Photometric Laboratory Targetti. These measurements are performed at a room temperature equal to 25±1 °C as required by UNI EN 13032-1 - Light and lighting - Measurement and presentation of photometric data of lamps and luminaires - Part 1.

The photometric values quoted are dependent on the optical system to which they relate, and from the light source used. In order to improve its production, the Company reserves the right to change these optical systems and consequently relative photometric data without notice.

This catalog shows the only photometries for the 3000K color temperature version, to consult the photometric data of the other versions, please refer to the website www.targetti.com

For ease of use, the photometric curve present within this catalogue is shown and explained below.

Photometric data are available in the "download" section of www.targetti.com, in digital format.

The photometric curves shown in this catalogue are compiled according to the "C-γ" international reference system, where the C0-C180 plane is perpendicular to the fixtures and the C90-C270 plane is parallel to the fixtures, as depicted in the figure. For symmetrical and rotationally symmetric fixtures therefore, a single curve is used.

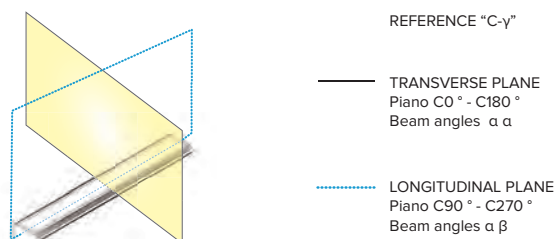

POLAR DIAGRAM

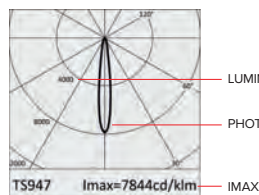

PHOTOMETRIC CODE

3000K Ra84		KELVIN - IRC
Fixture Power	23W	FIXTURE POWER
Source Flux	2886lm	LED FLUX
Fixture Flux	2453lm	FIXTURE FLUX
Efficacy	107lm/W	EFFICACY
Imax	22638cd	IMAX

H(m)	D(m)	E _{max} (lx)	
	14°		BEAM ANGLE
1	0.24	22638	DISTANCE FROM THE PLAN (m)
2	0.48	5659	
3	0.72	2515	Ø LUMINOUS CONE (m)
4	0.96	1415	
5	1.20	906	MAX ILLUMINATION (lx)

CIE FLUX CODE - The Commission Internationale de l'Eclairage (CIE) provides a classification of luminaires according to the distribution of the flux delivered within certain limits of solid angle. The first three numbers indicate the fluxes contained in the cones identified by solid angles equal to π/2, π, 3/2π. The fourth number gives the percentage of direct light compared to total emission. The fifth is the ratio between the total emission of the fixtures and total emission of the lamps (efficiency of the fixtures). The 5 codes are expressed in percentages.

FIXTURE PERFORMANCE - In accordance with EN 13032-2 - Light and lighting - Measurement and presentation of photometric data of lamps and luminaires - Part 2: Presentation of data for indoor and outdoor work places - the performance of lighting fixtures is indicated by the acronym "LOR" (Light Output Ratio) defined as the ratio of the luminous flux emitted by a fixture and the total flux of the sources used. For direct/indirect light fixtures appliances, the regulation introduces the components "DLOR" (Down Light Output

Ratio) and "ULOR" (Up Light Output Ratio). These components show the distribution of luminous flux of the fixtures in the lower and upper half-space. The 3 parameters are expressed as percentages.

UGR VALUES - The UGR (Unified Glare Rating) method was introduced by the CIE (Commission Internationale de l'Eclairage) with the CIE 117 – 1995 publication "Glare Discomfort in Interior Lighting" in order to have a unified method for evaluating glare. Unlike the previous method (Diagram of light or Söllner), the index of glare depends on both the characteristics of the fixtures, and the characteristics of the environment in which it is installed, taking into account the relative position of observer- fixtures.

The UGR glare index is calculated from the size of the room, the type of light fixtures, its size and the surface reflection properties of the environment. It is expressed by the formula:

$$UGR = 8 \log \left(\frac{0,25}{L_b} \sum \frac{L^2 \pi}{\rho^2} \right)$$

- UGR: A value that defines the class of the annoying glare (or glare that causes disruption without affecting the view of objects) directly produced by the fixtures of an indoor lighting system.
- Background luminance L_b : luminance of the visual field, in cd/sqm , with the exclusion of glaring sources.
- Fixtures luminance L : luminance of the luminous parts, in cd/sqm , of each appliance in the direction of observation.
- Solid angle π : solid angle, in steradian, of the luminous parts of each illumination fixture in the direction of the eye of the observer.
- Guth's position index p : a value that defines the offset angle to the axis of vision for each individual luminary.

- Y transverse dimension of the room equal to $8H$
 Reflectance index of the ceiling, walls and floor, respectively, equal to 0.7, 0.5, 0.2

To aid better understanding, the UGR values reported in the polar diagram of the lighting fixtures have been grouped into the following illustrative classes by type of application, as specified in UNI EN 12464-1:

- <16 maximum viewing comfort
- <19 comfort required in offices
- <22 comfort required in other work places
- <25 need for reduced visual comfort
- <28 extremely low visual comfort



Figura 1 / Figure 1

UGR glare index values are between 10 and 30, from minimum to maximum probability of distress.

- UGR C 0: refers to the transversal direction of observation of the fixtures
- UGR C 90: refers to the longitudinal direction of observation of the fixtures.

Glare ratio reported in polar diagrams are calculated in relation to a local standard, as provided for by regulation CIE 117, having the following characteristics (Figure 1):

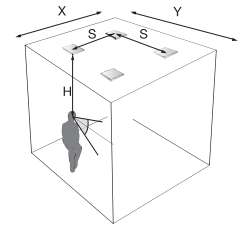
The size of the room as well as the distance between fixtures in both directions are specified in relation to the distance H between the fixture plane and the observer plane (usually assumed to be equal to 1.2 m):

- S Distance between fixtures in both directions equal to $0.25H$
- X longitudinal dimension of the room equal to $4H$

LUMINANCE VALUES - The UNI EN 12464-1 - Light and lighting - Lighting of workplaces - Part 1: internal workplaces - prescribes the boundary values of average luminance of the lighting equipment at elevation angles of 65° and above from the downward vertical, radially around the luminaires, for work stations where display screens which are vertical or inclined up to 15° tilt angle are used.

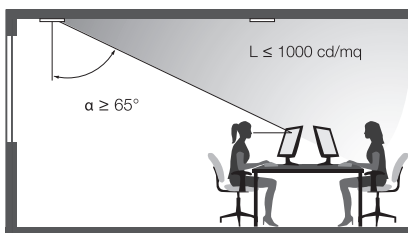

Screen high state luminance	High luminance screen >200cd/mq	Medium luminance screen ≤ 200cd/mq
Case A	≤ 3000 cd/mq	≤ 1500 cd/mq
Case B	≤ 1500 cd/mq	≤ 1000 cd/mq

- Case A: flat screens operating at positive polarity with normal requirements concerning colour and details of the shown information, as used in office, education, etc.
- Case B: to flat screens operating at negative polarity and/or with higher requirements concerning colour and details of the shown information, as used for CAD colour inspection, etc.

INDEX FOR CODE

COD.	PAG.	COD.	PAG.	COD.	PAG.
1E0388	573, 587, 589, 592, 599, 601	1E2394	585, 586, 588, 590, 591	1E2558	752
1E0990	622, 624, 627	1E2402	587, 589	1E2559	752
1E0993	608, 612, 616, 618, 622, 694, 696, 699, 720, 723, 735, 737, 779	1E2494	587, 589, 599, 601, 603, 609, 613, 617, 619, 622, 624, 665, 668, 673, 678, 683, 687, 695, 697, 700, 703, 721, 771, 779	1E2560	750
1E0994	622, 624, 626	1E2495	550, 554, 587, 589, 592, 599, 601, 770	1E2561	591
1E0995	703, 705	1E2496	587, 589, 592	1E2562	591
1E0995FE	700	1E2497	593	1E2563	775
1E0996	622, 624, 626	1E2498	593	1E2564	774, 775
1E1001	621	1E2499	593	1E2565	298
1E1002	621	1E2500	593	1E2566	298
1E1008	621	1E2501	595	1E2567	298
1E1011	621	1E2502	595	1E2568	298
1E1012	621	1E2503	595	1E2569	298
1E1018	621	1E2504	595	1E2570	298
1E1021	621	1E2505	595	1E2571	299
1E1022	621	1E2506	595	1E2572	299
1E1028	621	1E2507	595	1E2573	299
1E1385	623, 703	1E2508	595	1E2574	299
1E1401	575, 626, 704, 784	1E2509	597	1E2575	299, 752
1E1409	625	1E2510	597	1E2576	299, 752, 755, 757
1E1410	704	1E2511	597	1E2577	299, 753
1E1713	627, 705, 785	1E2512	597	1E2578	299, 753, 755, 757
1E1715	685, 785	1E2513	597	1E2579	299, 753
1E1854	625	1E2514	597	1E2580	299, 753, 757
1E1855	704	1E2515	597	1E2581	633
1E1906	786	1E2516	597	1E2582	633
1E1929	786	1E2517	597	1E2583	633
1E2264	573	1E2518	597	1E2584	633
1E2265	573	1E2519	597	1E2585	633
1E2266	573	1E2520	597	1E2586	633
1E2267	577	1E2521	593, 595, 597, 600	1E2587	633
1E2268	577	1E2522	593, 595, 597, 600	1E2588	633
1E2269	577	1E2523	599	1E2589	634
1E2272	572	1E2524	599, 601	1E2590	634
1E2274	572	1E2525	594, 596, 598, 600	1E2591	634
1E2275	572	1E2526	594, 596, 598, 600	1E2592	634
1E2320	594, 596, 598, 601	1E2533	594, 596, 598, 601	1E2593	634
1E2321	366, 594, 596, 598, 601	1E2539	775	1E2594	634
1E2323	594, 596, 598, 601	1E2540	775	1E2595	634
1E2367	623	1E2541	775	1E2596	634
1E2368	623	1E2542	775	1E2597	635
1E2369	623	1E2543	751	1E2598	635
1E2370	623	1E2544	751	1E2599	635
1E2371	703	1E2545	751	1E2600	635
1E2372	703	1E2546	751	1E2601	635
1E2373	703	1E2547	750	1E2602	635
1E2374	703	1E2548	752	1E2603	635
1E2381	575	1E2549	752	1E2604	635
1E2382	574, 575	1E2550	752	1E2605	632
1E2383	574, 575	1E2551	750	1E2606	632
1E2386	585	1E2552	751	1E2607	632
1E2387	585	1E2553	751	1E2608	632
1E2388	588	1E2554	751	1E2609	632
1E2389	588	1E2555	751	1E2610	632
1E2390	588	1E2556	750	1E2611	632
1E2391	588	1E2557	752	1E2612	632
1E2392	588			1E2613	633
1E2393	588			1E2614	633
				1E2615	633
				1E2616	633
				1E2617	633
				1E2618	633
				1E2619	633
				1E2620	633

COD.	PAG.	COD.	PAG.	COD.	PAG.
1E2621	635	1E2684	549	1E2747	548
1E2622	635	1E2685	549	1E2748	548
1E2623	635	1E2686	549	1E2752	636, 640
1E2624	635	1E2687	549	1E2753	636, 640
1E2625	635	1E2688	549	1E2754	636, 641
1E2626	635	1E2689	546	1E2755	637, 641
1E2627	635	1E2690	546	1E2756	637, 641
1E2628	635	1E2691	546	1E2757	637, 641
1E2629	632	1E2692	546	1E2758	637, 641
1E2630	632	1E2693	546	1E2759	637, 641
1E2631	632	1E2694	546	1E2760	637, 641
1E2632	632	1E2695	546	1E2761	636, 641
1E2633	632	1E2696	546	1E2762	550, 636
1E2634	632	1E2697	547	1E2763	550, 636
1E2635	632	1E2698	547	1E2764	550, 636
1E2636	632	1E2699	547	1E2765	550, 636
1E2637	634	1E2700	547	1E2766	683, 684
1E2638	634	1E2701	547	1E2767	554, 587, 592, 641, 680, 788
1E2639	634	1E2702	547	1E2768	586
1E2640	634	1E2703	547	1E2769	550, 554, 568, 587, 589, 599, 601, 603, 609, 613, 617, 619, 622, 624, 636, 641, 655, 665, 668, 673, 678, 683, 687, 695, 697, 700, 703, 718, 721, 771, 779
1E2641	634	1E2704	547	1E2770	603
1E2642	634	1E2705	549	1E2771	603
1E2643	634	1E2706	549	1E2772	603
1E2644	634	1E2707	549	1E2773	603
1E2645	635	1E2708	549	1E2774	603
1E2646	635	1E2709	549	1E2775	603
1E2647	635	1E2710	549	1E2779	676
1E2648	635	1E2711	549	1E2780	676
1E2649	635	1E2712	549	1E2781	676
1E2650	635	1E2713	547	1E2782	676
1E2651	635	1E2714	547	1E2783	676
1E2652	635	1E2715	547	1E2784	676
1E2653	632	1E2716	547	1E2785	676
1E2654	632	1E2717	547	1E2786	676
1E2655	632	1E2718	547	1E2806	677
1E2656	632	1E2719	547	1E2807	677
1E2657	633	1E2720	547	1E2816	678
1E2658	633	1E2721	548	1E2817	678
1E2659	633	1E2722	548	1E2818	678
1E2660	633	1E2723	548	1E2819	678
1E2661	634	1E2724	548	1E2820	678
1E2662	634	1E2725	548	1E2821	678
1E2663	634	1E2726	548	1E2822	678
1E2664	634	1E2727	548	1E2823	678, 680
1E2665	546	1E2728	548	1E2824	678, 680
1E2666	546	1E2729	549	1E2825	665, 668, 678, 680
1E2667	546	1E2730	549	1E2826	678, 680
1E2668	546	1E2731	549	1E2827	682
1E2669	546	1E2732	549	1E2828	682
1E2670	546	1E2733	549	1E2829	682
1E2671	546	1E2734	549	1E2830	682
1E2672	546	1E2735	549	1E2831	682
1E2673	548	1E2736	549	1E2832	682
1E2674	548	1E2737	546	1E2833	684
1E2675	548	1E2738	546	1E2834	684
1E2676	548	1E2739	546	1E2835	683, 685
1E2677	548	1E2740	546		
1E2678	548	1E2741	547		
1E2679	548	1E2742	547		
1E2680	548	1E2743	547		
1E2681	549	1E2744	547		
1E2682	549	1E2745	548		
1E2683	549	1E2746	548		

INDEX FOR CODE

COD.	PAG.	COD.	PAG.	COD.	PAG.
1E2846	683, 685	1E2953	729	1E3004EL	667
1E2847	683, 685	1E2954	729	1E3005D	667
1E2848	683, 685	1E2955	729	1E3005DA	667
1E2849	682	1E2956	729	1E3005EL	667
1E2850	682	1E2957	729	1E3006	672
1E2851	682	1E2958	729	1E3007	672
1E2852	682	1E2959	729	1E3008	672
1E2853	682	1E2960	729	1E3009	672
1E2854	683	1E2961	729	1E3010	672
1E2855	683, 684	1E2967	770	1E3011	672
1E2856	683, 685	1E2968	770	1E3012	672
1E2857	687	1E2969	770	1E3013	672
1E2858	687	1E2970	770	1E3014	672
1E2859	687	1E2971	770	1E3015	672
1E2860	687	1E2972	770	1E3016	672
1E2861	774	1E2978	676	1E3017	667
1E2862	774	1E2979	676	1E3018	667
1E2863	774	1E2980	677	1E3019	667
1E2864	774	1E2981	677	1E3020	667
1E2865	775	1E2982	677	1E3021	667
1E2866	775	1E2983	677	1E3022	668
1E2867	756	1E2984	677	1E3023	667
1E2868	756	1E2985	677	1E3024	667
1E2869	756	1E2986	670	1E3025	667
1E2870	756	1E2987	670	1E3026	664, 667
1E2871	756	1E2988	670	1E3027	668
1E2872	756	1E2989	670	1E3028	664, 667
1E2873	756	1E2990	670	1E3029	668
1E2874	756	1E2991	670	1E3033D	671
1E2875	756	1E2992	670	1E3033DA	671
1E2876	756	1E2993	670	1E3033EL	671
1E2877	751	1E2994D	666	1E3034D	671
1E2878	751	1E2994DA	666	1E3034DA	671
1E2879	751	1E2994EL	666	1E3034EL	671
1E2880	751	1E2995D	666	1E3035	752, 755, 757
1E2881	750	1E2995DA	666	1E3036	752, 755, 757
1E2882	750	1E2995EL	666	1E3037	752, 755, 757
1E2883	750	1E2996D	666	1E3038	752, 755, 757
1E2884	752	1E2996DA	666	1E3039	752, 755, 757
1E2885	752	1E2996EL	666	1E3040	775
1E2886	752	1E2997D	666	1E3041	775
1E2887	750	1E2997DA	666	1E3042	775
1E2888	750	1E2997EL	666	1E3043	775
1E2889	750	1E2998D	666	1E3044	775
1E2890	754	1E2998DA	666	1E3045	637, 641
1E2891	754	1E2998EL	666	1E3046	637, 641
1E2892	754	1E2999D	666	1E3047	637, 641
1E2893	754	1E2999DA	666		
1E2894	754	1E2999EL	666		
1E2895	754	1E3000D	666		
1E2896	754	1E3000DA	666	1E3048	300, 550, 568, 609, 613, 617, 619, 637, 655, 665, 668, 673, 695, 698, 700, 718, 721, 724, 735, 738, 745, 767, 779, 793
1E2897	754	1E3000EL	666		
1E2898	754	1E3001D	666		
1E2899	754	1E3001DA	666		
1E2900	755	1E3001EL	666		
1E2901	753	1E3002D	666	1E3049	300, 550, 568, 609, 613, 617, 619, 637, 655, 665, 668, 673, 695, 698, 700, 718, 721, 724, 735, 738, 745, 767, 779, 793
1E2902	753	1E3002DA	666		
1E2906	753, 755	1E3002EL	666		
1E2907	755	1E3003D	666		
1E2909	759	1E3003DA	666		
1E2910	759	1E3003EL	666		
1E2911	759	1E3004D	667		
1E2912	759	1E3004DA	667		

COD.	PAG.	COD.	PAG.	COD.	PAG.
1E3054	590	1E3081EL	664	1E3128	606
1E3055	590	1E3082D	662	1E3129	606
1E3056EL	669	1E3082DA	662	1E3130	606
1E3057EL	669	1E3082EL	662	1E3131	606
1E3058EL	669	1E3083D	662	1E3132	606
1E3059EL	669	1E3083DA	662	1E3133	606
1E3060EL	669	1E3083EL	662	1E3136	610
1E3061EL	669	1E3084D	663	1E3137	610
1E3062EL	669	1E3084DA	663	1E3138	610
1E3063EL	669	1E3084EL	663	1E3139	610
1E3064D	662	1E3085D	663	1E3140	610
1E3064DA	662	1E3085DA	663	1E3141	610
1E3064EL	662	1E3085EL	663	1E3144	616
1E3065D	662	1E3086D	663	1E3145	616
1E3065DA	662	1E3086DA	663	1E3146	618
1E3065EL	662	1E3086EL	663	1E3147	618
1E3066D	662	1E3087D	664	1E3148	722
1E3066DA	662	1E3087DA	664	1E3149	722
1E3066EL	662	1E3087EL	664	1E3150	722
1E3067D	663	1E3088	664	1E3151	722
1E3067DA	663	1E3089	664	1E3152	722
1E3067EL	663	1E3090	664	1E3153	722
1E3068D	663	1E3091	664	1E3154	722
1E3068DA	663	1E3092	664	1E3155	722
1E3068EL	663	1E3093	665	1E3156	722
1E3069D	663	1E3094	664	1E3157	722
1E3069DA	663	1E3095	664	1E3158	722
1E3069EL	663	1E3096	664	1E3159	722
1E3070D	662	1E3097	665	1E3160	722
1E3070DA	662	1E3098	665	1E3161	722
1E3070EL	662	1E3099	551	1E3162	722
1E3071D	662	1E3100	551	1E3163	722
1E3071DA	662	1E3101	551	1E3164	722
1E3071EL	662	1E3102	551	1E3165	722
1E3072D	662	1E3103	552	1E3166	723
1E3072DA	662	1E3104	552	1E3167	699
1E3072EL	662	1E3105	552	1E3168	699
1E3073D	663	1E3106	552	1E3169	699
1E3073DA	663	1E3107	553	1E3170	699
1E3073EL	663	1E3108	553	1E3171	699
1E3074D	663	1E3109	553	1E3172	699
1E3074DA	663	1E3110	553	1E3173	679
1E3074EL	663	1E3111	638	1E3174	679
1E3075D	663	1E3112	638	1E3175	609
1E3075DA	663	1E3113	638	1E3176	613
1E3075EL	663	1E3114	638	1E3177	617
1E3076D	662	1E3115	639	1E3178	619
1E3076DA	662	1E3116	639		
1E3076EL	662	1E3117	639		608, 612, 616, 618, 694, 696, 699, 720, 723, 735, 737, 778
1E3077D	662	1E3118	639	1E3179	
1E3077DA	662	1E3119	640		
1E3077EL	662	1E3120	640	1E3180	723
1E3078D	663	1E3121	640	1E3181	723
1E3078DA	663	1E3122	640	1E3184	554, 587, 592, 641
1E3078EL	663	1E3123	591	1E3185	774, 775
1E3079D	663	1E3124	679	1E3187	665
1E3079DA	663	1E3125	679	1E3188	664
1E3079EL	663	1E3126D	667	1E3189DA	745
1E3080D	663	1E3126DA	667	1E3189EL	745
1E3080DA	663	1E3126EL	667	1E3190DA	745
1E3080EL	663	1E3127D	667	1E3190EL	745
1E3081D	664	1E3127DA	667	1E3191DA	745
1E3081DA	664	1E3127EL	667	1E3191EL	745

INDEX FOR CODE

COD.	PAG.	COD.	PAG.	COD.	PAG.
1E3192DA	717	1E3264	649	1E3297EL	653
1E3192EL	717	1E3265	649	1E3298DA	653
1E3195DA	717	1E3266	649	1E3298EL	653
1E3195EL	717	1E3267	649	1E3299DA	653
1E3198DA	717	1E3268DA	650	1E3299EL	653
1E3198EL	717	1E3268EL	650	1E3300DA	653
1E3201DA	717	1E3269DA	650	1E3300EL	653
1E3201EL	717	1E3269EL	650	1E3301DA	653
1E3204DA	717	1E3270DA	650	1E3301EL	653
1E3204EL	717	1E3270EL	650	1E3302DA	653
1E3207DA	717	1E3271DA	650	1E3302EL	653
1E3207EL	717	1E3271EL	650	1E3303DA	653
1E3210DA	717	1E3272DA	650	1E3303EL	653
1E3210EL	717	1E3272EL	650	1E3304	654
1E3213DA	717	1E3273DA	650	1E3305	568, 655, 745
1E3213EL	717	1E3273EL	650	1E3306	654
1E3216DA	717	1E3274DA	650	1E3307	645
1E3216EL	717	1E3274EL	650	1E3308	645
1E3219	717	1E3275DA	650	1E3309	645
1E3220	645	1E3275EL	650	1E3310	645
1E3221	645	1E3276DA	650	1E3311	646
1E3222	645	1E3276EL	650	1E3312	646
1E3223	645	1E3277DA	650	1E3313	646
1E3224	645	1E3277EL	650	1E3314	646
1E3225	645	1E3278DA	650	1E3315	646
1E3226	645	1E3278EL	650	1E3316	646
1E3227	645	1E3279DA	650	1E3317	646
1E3228	645	1E3279EL	650	1E3318	646
1E3229	645	1E3280DA	651	1E3319	647
1E3230	645	1E3280EL	651	1E3320	647
1E3231	645	1E3281DA	651	1E3321	647
1E3232	646	1E3281EL	651	1E3322	647
1E3233	646	1E3282DA	651	1E3323	647
1E3234	646	1E3282EL	651	1E3324	647
1E3235	646	1E3283DA	651	1E3325	647
1E3236	646	1E3283EL	651	1E3326	647
1E3237	646	1E3284DA	652	1E3327	647
1E3238	646	1E3284EL	652	1E3328	647
1E3239	646	1E3285DA	652	1E3329	647
1E3240	646	1E3285EL	652	1E3330	647
1E3241	646	1E3286DA	652	1E3331	648
1E3242	646	1E3286EL	652	1E3332	648
1E3243	646	1E3287DA	652	1E3333	648
1E3244	647	1E3287EL	652	1E3334	648
1E3245	647	1E3288DA	652	1E3335	648
1E3246	647	1E3288EL	652	1E3336	648
1E3247	647	1E3289DA	652	1E3337	648
1E3248	648	1E3289EL	652	1E3338	648
1E3249	648	1E3290DA	652	1E3339	648
1E3250	648	1E3290EL	652	1E3340	648
1E3251	648	1E3291DA	652	1E3341	648
1E3252	648	1E3291EL	652	1E3342	648
1E3253	648	1E3292DA	653	1E3343	649
1E3254	648	1E3292EL	653	1E3344	649
1E3255	648	1E3293DA	653	1E3345	649
1E3256	649	1E3293EL	653	1E3346	649
1E3257	649	1E3294DA	653	1E3347	650
1E3258	649	1E3294EL	653	1E3348	650
1E3259	649	1E3295DA	653	1E3349	650
1E3260	649	1E3295EL	653	1E3350	650
1E3261	649	1E3296DA	653	1E3351	650
1E3262	649	1E3296EL	653	1E3352	650
1E3263	649	1E3297DA	653	1E3353	650

COD.	PAG.	COD.	PAG.	COD.	PAG.
1E3354	650	1E3386DA	654	1E3434	767
1E3355DA	651	1E3386EL	654	1E3435	767
1E3355EL	651	1E3387DA	654	1E3436	767
1E3356DA	651	1E3387EL	654	1E3437	717
1E3356EL	651	1E3388DA	654	1E3438	717
1E3357DA	651	1E3388EL	654	1E3439	717
1E3357EL	651	1E3389DA	654	1E3440	718
1E3358DA	651	1E3389EL	654	1E3441	719
1E3358EL	651	1E3390DA	654	1E3442DA	719
1E3359DA	651	1E3390EL	654	1E3442EL	719
1E3359EL	651	1E3399	745	1E3443DA	719
1E3360DA	651	1E3404	574	1E3443EL	719
1E3360EL	651	1E3405	574	1E3444DA	719
1E3361DA	651	1E3406	574	1E3444EL	719
1E3361EL	651	1E3407	574	1E3445	719
1E3362DA	651	1E3410DA	766	1E3446	719
1E3362EL	651	1E3410EL	766	1E3447	720
1E3363DA	651	1E3411DA	766	1E3448	767
1E3363EL	651	1E3411EL	766	1E3449	767
1E3364DA	651	1E3412DA	766	1E3450	718, 778
1E3364EL	651	1E3412EL	766	1E3451	606
1E3365DA	651	1E3413DA	766	1E3452	607
1E3365EL	651	1E3413EL	766	1E3453	607
1E3366DA	651	1E3414DA	766	1E3454	606
1E3366EL	651	1E3414EL	766	1E3455	607
1E3367DA	652	1E3415DA	766	1E3456	607
1E3367EL	652	1E3415EL	766	1E3457	606
1E3368DA	652	1E3416DA	766	1E3458	607
1E3368EL	652	1E3416EL	766	1E3459	607
1E3369DA	652	1E3417DA	766	1E3460	609
1E3369EL	652	1E3417EL	766	1E3461	610
1E3370DA	652	1E3418DA	766	1E3462	611
1E3370EL	652	1E3418EL	766	1E3463	611
1E3371DA	652	1E3419DA	766	1E3464	610
1E3371EL	652	1E3419EL	766	1E3465	611
1E3372DA	652	1E3420DA	766	1E3466	611
1E3372EL	652	1E3420EL	766	1E3467	610
1E3373DA	652	1E3421DA	766	1E3468	611
1E3373EL	652	1E3421EL	766	1E3469	611
1E3374DA	652	1E3422DA	765	1E3470	613
1E3374EL	652	1E3422EL	765	1E3471	607
1E3375DA	652	1E3423DA	765	1E3472	607
1E3375EL	652	1E3423EL	765	1E3473	607
1E3376DA	652	1E3424DA	765	1E3474	607
1E3376EL	652	1E3424EL	765	1E3475	607
1E3377DA	652	1E3425DA	765	1E3476	607
1E3377EL	652	1E3425EL	765	1E3477	607
1E3378DA	652	1E3426DA	765	1E3478	607
1E3378EL	652	1E3426EL	765	1E3479	607
1E3379DA	653	1E3427DA	765	1E3480	611
1E3379EL	653	1E3427EL	765	1E3481	611
1E3380DA	653	1E3428DA	765	1E3482	611
1E3380EL	653	1E3428EL	765	1E3483	611
1E3381DA	653	1E3429DA	765	1E3484	611
1E3381EL	653	1E3429EL	765	1E3485	611
1E3382DA	653	1E3430DA	765	1E3486	611
1E3382EL	653	1E3430EL	765	1E3487	611
1E3383DA	654	1E3431DA	765	1E3488	611
1E3383EL	654	1E3431EL	765	1E3489	608
1E3384DA	654	1E3432DA	765	1E3490	608
1E3384EL	654	1E3432EL	765	1E3491	608
1E3385DA	654	1E3433DA	765	1E3492	608
1E3385EL	654	1E3433EL	765	1E3493	608

INDEX FOR CODE

COD.	PAG.	COD.	PAG.	COD.	PAG.
1E3494	608	1E3543DA	736	1E3599	560
1E3495	608	1E3543EL	736	1E3600	560
1E3496	608	1E3544	736	1E3601	560
1E3497	608	1E3545DA	736	1E3602	560
1E3498	612	1E3545EL	736	1E3603	560
1E3499	612	1E3546	736	1E3604	560
1E3500	612	1E3547DA	736	1E3605	560
1E3501	612	1E3547EL	736	1E3606	560
1E3502	612	1E3548	736	1E3607	560
1E3503	612	1E3549DA	736	1E3608	560
1E3504	612	1E3549EL	736	1E3609	560
1E3505	612	1E3550	736	1E3610	560
1E3506	612	1E3551DA	737	1E3611	560
1E3507	550, 554	1E3551EL	737	1E3612	560
1E3508	550, 554	1E3552	737	1E3613	561
1E3509	550, 554	1E3553DA	737	1E3614	561
1E3510	767	1E3553EL	737	1E3615	561
1E3511	719	1E3554	737	1E3616	561
1E3512DA	719	1E3555DA	737	1E3617	561
1E3512EL	719	1E3555EL	737	1E3618	561
1E3513	719	1E3556	737	1E3619	561
1E3514DA	719	1E3557	567, 654	1E3620	561
1E3514EL	719	1E3558	567, 654	1E3621	561
1E3515	719	1E3559	568, 654	1E3622	561
1E3516DA	719	1E3560	568, 654	1E3623	561
1E3516EL	719	1E3561	558	1E3624	561
1E3517	600	1E3562	558	1E3625	561
1E3518	600	1E3563	558	1E3626	561
1E3519	600	1E3564	558	1E3627	561
1E3520	600	1E3565	558	1E3628	561
1E3521DA	734	1E3566	558	1E3629	561
1E3521EL	734	1E3567	558	1E3630	561
1E3522	734	1E3568	558	1E3631	561
1E3523DA	734	1E3569	558	1E3632	561
1E3523EL	734	1E3570	558	1E3633	562
1E3524	734	1E3571	558	1E3634	562
1E3525DA	734	1E3572	558	1E3635	562
1E3525EL	734	1E3573	558	1E3636	562
1E3526	734	1E3574	558	1E3637	562
1E3527DA	734	1E3575	558	1E3638	562
1E3527EL	734	1E3576	558	1E3639	562
1E3528	734	1E3577	559	1E3640	562
1E3529DA	734	1E3578	559	1E3641	562
1E3529EL	734	1E3579	559	1E3642	562
1E3530	734	1E3580	559	1E3643	562
1E3531DA	734	1E3581	559	1E3644	562
1E3531EL	734	1E3582	559	1E3645	562
1E3532	734	1E3583	559	1E3646	562
1E3533DA	735	1E3584	559	1E3647	562
1E3533EL	735	1E3585	559	1E3648	562
1E3534	735	1E3586	559	1E3649	563
1E3535DA	735	1E3587	559	1E3650	563
1E3535EL	735	1E3588	559	1E3651	563
1E3536	735	1E3589	559	1E3652	563
1E3537DA	735	1E3590	559	1E3653	563
1E3537EL	735	1E3591	559	1E3654	563
1E3538	735	1E3592	559	1E3655	563
1E3539DA	736	1E3593	559	1E3656	563
1E3539EL	736	1E3594	559	1E3657DA	563
1E3540	736	1E3595	559	1E3657EL	563
1E3541DA	736	1E3596	559	1E3658DA	563
1E3541EL	736	1E3597	560	1E3658EL	563
1E3542	736	1E3598	560	1E3659DA	563

COD.	PAG.	COD.	PAG.	COD.	PAG.
1E3659EL	563	1E3691DA	565	1E3722EL	567
1E3660DA	563	1E3691EL	565	1E3723DA	567
1E3660EL	563	1E3692DA	565	1E3723EL	567
1E3661DA	563	1E3692EL	565	1E3724DA	567
1E3661EL	563	1E3693DA	565	1E3724EL	567
1E3662DA	563	1E3693EL	565	1E3725DA	567
1E3662EL	563	1E3694DA	565	1E3725EL	567
1E3663DA	563	1E3694EL	565	1E3726DA	567
1E3663EL	563	1E3695DA	565	1E3726EL	567
1E3664DA	563	1E3695EL	565	1E3727DA	567
1E3664EL	563	1E3696DA	565	1E3727EL	567
1E3665DA	563	1E3696EL	565	1E3728DA	567
1E3665EL	563	1E3697DA	565	1E3728EL	567
1E3666DA	563	1E3697EL	565	1E3729	567
1E3666EL	563	1E3698DA	565	1E3730	567
1E3667DA	563	1E3698EL	565	1E3731	567
1E3667EL	563	1E3699DA	565	1E3732	567
1E3668DA	563	1E3699EL	565	1E3733	567
1E3668EL	563	1E3700DA	565	1E3734	567
1E3669DA	564	1E3700EL	565	1E3735	567
1E3669EL	564	1E3701DA	565	1E3736	778
1E3670DA	564	1E3701EL	565	1E3737	778
1E3670EL	564	1E3702DA	565	1E3738	778
1E3671DA	564	1E3702EL	565	1E3739	778
1E3671EL	564	1E3703DA	565	1E3740	778
1E3672DA	564	1E3703EL	565	1E3741	778
1E3672EL	564	1E3704DA	565	1E3742	722
1E3673DA	564	1E3704EL	565	1E3743	722
1E3673EL	564	1E3705DA	566	1E3744	722
1E3674DA	564	1E3705EL	566	1E3745	722
1E3674EL	564	1E3706DA	566	1E3746	722
1E3675DA	564	1E3706EL	566	1E3747	722
1E3675EL	564	1E3707DA	566	1E3748	722
1E3676DA	564	1E3707EL	566	1E3749	722
1E3676EL	564	1E3708DA	566	1E3750	722
1E3677DA	564	1E3708EL	566	1E3751	722
1E3677EL	564	1E3709DA	566	1E3752	722
1E3678DA	564	1E3709EL	566	1E3753	722
1E3678EL	564	1E3710DA	566	1E3754	722
1E3679DA	564	1E3710EL	566	1E3755	722
1E3679EL	564	1E3711DA	566	1E3756	722
1E3680DA	564	1E3711EL	566	1E3757	722
1E3680EL	564	1E3712DA	566	1E3758	722
1E3681DA	564	1E3712EL	566	1E3759	722
1E3681EL	564	1E3713DA	566	1E3760DA	717
1E3682DA	564	1E3713EL	566	1E3760EL	717
1E3682EL	564	1E3714DA	566	1E3761DA	717
1E3683DA	564	1E3714EL	566	1E3761EL	717
1E3683EL	564	1E3715DA	566	1E3762DA	717
1E3684DA	564	1E3715EL	566	1E3762EL	717
1E3684EL	564	1E3716DA	566	1E3763	719
1E3685DA	565	1E3716EL	566	1E3764DA	719
1E3685EL	565	1E3717DA	566	1E3764EL	719
1E3686DA	565	1E3717EL	566	1E3765	719
1E3686EL	565	1E3718DA	566	1E3766DA	719
1E3687DA	565	1E3718EL	566	1E3766EL	719
1E3687EL	565	1E3719DA	566	1E3767	696
1E3688DA	565	1E3719EL	566	1E3768	696
1E3688EL	565	1E3720DA	566	1E3769	696
1E3689DA	565	1E3720EL	566	1E3770	696
1E3689EL	565	1E3721DA	567	1E3771	696
1E3690DA	565	1E3721EL	567	1E3772	696
1E3690EL	565	1E3722DA	567	1E3773	693

INDEX FOR CODE

COD.	PAG.	COD.	PAG.	COD.	PAG.
1E3774	693	1T1716	184, 203, 247, 272, 598	1T2932DA	116
1E3775	693	1T1757	215, 216, 217, 321	1T2932EL	116
1E3776	693	1T1827	575, 626, 704, 784	1T2933	113, 115, 116, 117, 118, 138, 140, 141
1E3777	693	1T1898	576, 627, 685, 705, 787	1T2934	115
1E3778	693	1T1932	576, 685, 785	1T2935	113, 115, 116, 117, 118, 138, 140, 141
1E3779	693			1T2937	119, 143
1E3780	693	1T2219	228, 231, 232, 249, 262, 265, 270, 273, 277, 505	1T2939	113, 115, 116, 117
1E3781	693			1T2948D	121
1E3782	693	1T2220	228, 231, 232, 249, 262, 265, 270, 273, 277, 505	1T2948DA	121
1E3783	693			1T2948EL	121
1E3784	693	1T2221	228, 231, 232, 249, 262, 265, 270, 273, 277, 505	1T2949D	121
1E3785	693, 696			1T2949DA	121
1E3786	693, 696	1T2222	228, 231, 232, 249, 262, 265, 270, 274, 277, 505	1T2949EL	121
1E3787	697			1T2950D	121
1E3788	694	1T2223	228, 231, 232, 249, 262, 265, 270, 274, 277, 505	1T2950DA	121
1E3789	697			1T2950EL	121
1E3790	694	1T2224	228, 231, 232, 249, 262, 265, 270, 274, 277, 505	1T2951D	121
1E3791	697			1T2951DA	121
1E3792	694	1T2245	576, 626, 705, 784	1T2951EL	121
1E3793	697	1T2266	785	1T2952D	121
1E3794	697	1T2418	130	1T2952DA	121
1E3795	697	1T2833	143, 150	1T2952EL	121
1E3796	697	1T2921D	114	1T2953D	121
1E3797	697	1T2921DA	114	1T2953DA	121
1E3798	694	1T2921EL	114	1T2953EL	121
1E3799	694	1T2922D	114	1T2954D	121
1E3800	694	1T2922DA	114	1T2954DA	121
1E3801	694	1T2922EL	114	1T2954EL	121
1E3802	694	1T2923D	114	1T2955D	121
1E3803	693, 696	1T2923DA	114	1T2955DA	121
1E3804	693, 696	1T2923EL	114	1T2955EL	121
1E3805	697	1T2924D	114	1T2956D	122
1E3806	694	1T2924DA	114	1T2956DA	122
1T0123	503	1T2924EL	114	1T2956EL	122
1T0123DA	503	1T2925D	114	1T2957D	122
1T0124	503	1T2925DA	114	1T2957DA	122
1T0124DA	503	1T2925EL	114	1T2957EL	122
1T0130	504	1T2926D	114	1T2958D	122
1T0130DA	504	1T2926DA	114	1T2958DA	122
1T1173	129	1T2926EL	114	1T2958EL	122
1T1245	129	1T2927D	114	1T2959D	122
1T1463	130	1T2927DA	114	1T2959DA	122
1T1696	586, 589	1T2927EL	114	1T2959EL	122
1T1699	587, 589	1T2928D	114	1T2960	119
1T1700	586, 589	1T2928DA	114	1T2961	119
1T1701	586, 589	1T2928EL	114	1T2962	119
1T1702	586, 589	1T2929D	116	1T2963	314
1T1703	586, 589	1T2929DA	116	1T2965	314
1T1704	586, 589	1T2929EL	116	1T2966	299, 314, 321
1T1708	184, 203, 241, 247, 272, 598	1T2930D	116	1T2968	299, 314, 321
1T1709	184, 203, 241, 247, 272	1T2930DA	116	1T3035	113
1T1711	185, 204, 240, 248, 273, 599	1T2930EL	116	1T3076D	139
1T1712	184, 203, 247, 272, 598	1T2931D	116	1T3076DA	139
1T1713	184, 203, 247, 272, 598	1T2931DA	116	1T3076EL	139
1T1714	184, 203, 247, 272, 598	1T2931EL	116	1T3077D	139
1T1715	184, 203, 247, 272, 598	1T2932D	116	1T3077DA	139
				1T3077EL	139
				1T3080D	139
				1T3080DA	139
				1T3080EL	139
				1T3081D	139

COD.	PAG.	COD.	PAG.	COD.	PAG.
1T3081DA	139	1T3108DA	136	1T3135DA	144
1T3081EL	139	1T3108EL	136	1T3135EL	144
1T3082D	138	1T3109D	136	1T3136D	145
1T3082DA	138	1T3109DA	136	1T3136DA	145
1T3082EL	138	1T3109EL	136	1T3136EL	145
1T3083D	138	1T3112D	137	1T3137D	145
1T3083DA	138	1T3112DA	137	1T3137DA	145
1T3083EL	138	1T3112EL	137	1T3137EL	145
1T3084D	139	1T3113D	137	1T3138	142, 149
1T3084DA	139	1T3113DA	137	1T3139	142, 149
1T3084EL	139	1T3113EL	137	1T3140	142, 149, 261, 263, 314
1T3085D	139	1T3114D	136	1T3141	142, 149, 261, 263, 314
1T3085DA	139	1T3114DA	136	1T3142	143, 150, 185, 204, 241, 248, 262, 265, 273, 315
1T3085EL	139	1T3114EL	136	1T3143	185, 204, 248, 262, 265, 273, 315
1T3086D	139	1T3115D	136	1T3144	119, 123, 125, 126, 130, 143, 150, 155, 159, 186, 191, 204, 207, 209, 211, 213, 299, 316, 322
1T3086DA	139	1T3115DA	136	1T3157D	117
1T3086EL	139	1T3115EL	136	1T3157DA	117
1T3087D	139	1T3116D	137	1T3157EL	117
1T3087DA	139	1T3116DA	137	1T3158D	117
1T3087EL	139	1T3116EL	137	1T3158DA	117
1T3088D	140	1T3117D	137	1T3158EL	117
1T3088DA	140	1T3117DA	137	1T3159D	117
1T3088EL	140	1T3117EL	137	1T3159DA	117
1T3089D	140	1T3118D	136	1T3159EL	117
1T3089DA	140	1T3118DA	136	1T3160D	117
1T3089EL	140	1T3118EL	136	1T3160DA	117
1T3092D	146	1T3119D	136	1T3160EL	117
1T3092DA	146	1T3119DA	136	1T3162	500
1T3092EL	146	1T3119EL	136	1T3163	500
1T3093D	146	1T3120D	137	1T3164	500
1T3093DA	146	1T3120DA	137	1T3165	500
1T3093EL	146	1T3120EL	137	1T3166	501
1T3096D	147	1T3121D	137	1T3167	501
1T3096DA	147	1T3121DA	137	1T3168	501
1T3096EL	147	1T3121EL	137	1T3169	501
1T3097D	147	1T3124D	144	1T3170	502
1T3097DA	147	1T3124DA	144	1T3171	502
1T3097EL	147	1T3124EL	144	1T3172	502
1T3098D	146	1T3125D	144	1T3173	502
1T3098DA	146	1T3125DA	144	1T3174	500
1T3098EL	146	1T3125EL	144	1T3175	500
1T3099D	146	1T3128D	145	1T3176	500
1T3099DA	146	1T3128DA	145	1T3177	500
1T3099EL	146	1T3128EL	145	1T3178	501
1T3100D	147	1T3129D	145	1T3179	501
1T3100DA	147	1T3129DA	145	1T3180	501
1T3100EL	147	1T3129EL	145	1T3181	501
1T3101D	147	1T3130D	144	1T3182	500
1T3101DA	147	1T3130DA	144	1T3183	500
1T3101EL	147	1T3130EL	144	1T3184	500
1T3102D	146	1T3131D	144	1T3185	500
1T3102DA	146	1T3131DA	144	1T3186	501
1T3102EL	146	1T3131EL	144	1T3187	501
1T3103D	146	1T3132D	145	1T3188	501
1T3103DA	146	1T3132DA	145		
1T3103EL	146	1T3132EL	145		
1T3104D	147	1T3133D	145		
1T3104DA	147	1T3133DA	145		
1T3104EL	147	1T3133EL	145		
1T3105D	147	1T3134D	144		
1T3105DA	147	1T3134DA	144		
1T3105EL	147	1T3134EL	144		
1T3108D	136	1T3135D	144		

INDEX FOR CODE

COD.	PAG.	COD.	PAG.	COD.	PAG.
1T3189	501	1T3256D	114	1T3371EL	118
1T3190	502	1T3256DA	114	1T3372D	118
1T3191	502	1T3256EL	114	1T3372DA	118
1T3192	502	1T3257D	114	1T3372EL	118
1T3193	502	1T3257DA	114	1T3373D	118
1T3194	500	1T3257EL	114	1T3373DA	118
1T3195	500	1T3258D	114	1T3373EL	118
1T3196	500	1T3258DA	114	1T3374D	123
1T3197	500	1T3258EL	114	1T3374DA	123
1T3198	501	1T3259D	114	1T3374EL	123
1T3199	501	1T3259DA	114	1T3375D	123
1T3200	501	1T3259EL	114	1T3375DA	123
1T3201	501	1T3260D	116	1T3375EL	123
1T3202	500	1T3260DA	116	1T3376D	123
1T3203	500	1T3260EL	116	1T3376DA	123
1T3204	500	1T3261D	116	1T3376EL	123
1T3205	500	1T3261DA	116	1T3377D	123
1T3206	501	1T3261EL	116	1T3377DA	123
1T3207	501	1T3266D	121	1T3377EL	123
1T3208	501	1T3266DA	121	1T3378D	123
1T3209	501	1T3266EL	121	1T3378DA	123
1T3210	502	1T3267D	121	1T3378EL	123
1T3211	502	1T3267DA	121	1T3379D	123
1T3212	502	1T3267EL	121	1T3379DA	123
1T3213	502	1T3268D	121	1T3379EL	123
1T3214	500	1T3268DA	121	1T3422	142, 149
1T3215	500	1T3268EL	121	1T3423	142, 149, 261, 265, 315
1T3216	500	1T3269D	121	1T3424	142, 149, 261, 314
1T3217	500	1T3269DA	121	1T3425	142, 149, 261, 314
1T3218	501	1T3269EL	121	1T3426	142, 149, 261, 314
1T3219	501	1T3270D	122	1T3427	142, 149, 261, 314
1T3220	501	1T3270DA	122	1T3428	142, 149, 261, 314
1T3221	501	1T3270EL	122	1T3432	143, 150, 185, 204, 248, 262, 265, 273, 315
1T3222	500	1T3271D	122	1T3433	503
1T3223	500	1T3271DA	122	1T3434	503
1T3224	500	1T3271EL	122	1T3435	503
1T3225	500	1T3272	495	1T3436	503
1T3226	501	1T3273	495	1T3437	503
1T3227	501	1T3274	495	1T3438	503
1T3228	501	1T3275	495	1T3439	503
1T3229	501	1T3296	495	1T3440	503
1T3230	502	1T3297	495	1T3441	503
1T3231	502	1T3298	495	1T3442	503
1T3232	502	1T3299	495	1T3443	503
1T3233	502	1T3320	495	1T3444	503
1T3234	500	1T3321	495	1T3445	503
1T3235	500	1T3322	495	1T3446	503
1T3236	500	1T3323	495	1T3447	503
1T3237	500	1T3344	495	1T3448	503
1T3238	501	1T3345	495	1T3449	503
1T3239	501	1T3346	495	1T3450	503
1T3240	501	1T3347	495	1T3451	503
1T3241	501	1T3368D	118	1T3452	504
1T3242DA	504	1T3368DA	118	1T3453	504
1T3243	503	1T3368EL	118	1T3454	504
1T3244	503	1T3369D	118	1T3483	257
1T3245	503	1T3369DA	118	1T3484	257
1T3246	503	1T3369EL	118	1T3485	257
1T3247	503	1T3370D	118	1T3486	257
1T3248	505	1T3370DA	118	1T3491	257
1T3249	505	1T3370EL	118		
1T3250	505	1T3371D	118		
1T3251	505	1T3371DA	118		

COD.	PAG.	COD.	PAG.	COD.	PAG.
1T3492	257	1T3570D	145	1T3617EL	199
1T3493	257	1T3570DA	145	1T3618D	199
1T3494	257	1T3570EL	145	1T3618DA	199
1T3499	257	1T3572D	146	1T3618EL	199
1T3500	257	1T3572DA	146	1T3619D	199
1T3501	257	1T3572EL	146	1T3619DA	199
1T3502	257	1T3574D	147	1T3619EL	199
1T3529	113, 115, 116, 117, 118, 138, 140, 141	1T3574DA	147	1T3620D	200
1T3530	113, 115, 116, 117, 118, 138, 140, 141	1T3574EL	147	1T3620DA	200
1T3531	115	1T3575D	146	1T3620EL	200
1T3548D	136	1T3575DA	146	1T3621D	200
1T3548DA	136	1T3575EL	146	1T3621DA	200
1T3548EL	136	1T3576D	147	1T3621EL	200
1T3550D	137	1T3576DA	147	1T3622D	199
1T3550DA	137	1T3576EL	147	1T3622DA	199
1T3550EL	137	1T3577D	146	1T3622EL	199
1T3551D	136	1T3577DA	146	1T3623D	200
1T3551DA	136	1T3577EL	146	1T3623DA	200
1T3551EL	136	1T3578D	147	1T3623EL	200
1T3552D	137	1T3578DA	147	1T3624D	200
1T3552DA	137	1T3578EL	147	1T3624DA	200
1T3552EL	137	1T3586	574, 608, 612, 616, 618, 694, 696, 699, 720, 723, 735, 737, 778	1T3624EL	200
1T3553D	136	1T3587	608, 612, 616, 618, 694, 696, 699, 720, 723, 735, 737, 779	1T3625	299
1T3553DA	136	1T3588	608, 612, 616, 618, 694, 696, 699, 720, 723, 735, 737, 779	1T3627	299
1T3553EL	136	1T3607D	199	1T3684	268
1T3554D	137	1T3607DA	199	1T3684DA	268
1T3554DA	137	1T3607EL	199	1T3685	268
1T3554EL	137	1T3608D	199	1T3685DA	268
1T3556D	139	1T3608DA	199	1T3686	268
1T3556DA	139	1T3608EL	199	1T3686DA	268
1T3556EL	139	1T3609D	199	1T3687	268
1T3558D	139	1T3609DA	199	1T3687DA	268
1T3558DA	139	1T3609EL	199	1T3692	268
1T3558EL	139	1T3610D	199	1T3692DA	268
1T3559D	138	1T3610DA	199	1T3693	268
1T3559DA	138	1T3610EL	199	1T3693DA	268
1T3559EL	138	1T3611D	200	1T3694	269
1T3560D	139	1T3611DA	200	1T3694DA	269
1T3560DA	139	1T3611EL	200	1T3695	269
1T3560EL	139	1T3612D	200	1T3695DA	269
1T3561D	139	1T3612DA	200	1T3696	269
1T3561DA	139	1T3612EL	200	1T3697	217
1T3561EL	139	1T3613D	199	1T3698	217
1T3562D	140	1T3613DA	199	1T3699	215
1T3562DA	140	1T3613EL	199	1T3700	215
1T3562EL	140	1T3614D	200	1T3701	216
1T3564D	144	1T3614DA	200	1T3702	216
1T3564DA	144	1T3614EL	200	1T3725	119, 143
1T3564EL	144	1T3615D	200	1T3726	608, 612, 616, 618, 694, 696, 699, 720, 723, 735, 737
1T3566D	145	1T3615DA	200	1T3727	185, 204, 241, 248, 273, 599
1T3566DA	145	1T3615EL	200	1T3759	529
1T3566EL	145	1T3616D	199	1T3760	529
1T3567D	144	1T3616DA	199	1T3762	529
1T3567DA	144	1T3616EL	199	1T3763	529
1T3567EL	144	1T3617D	199	1T3765	515
1T3568D	145	1T3617DA	199	1T3766	515
1T3568DA	145			1T3768	515
1T3568EL	145			1T3769	515
1T3569D	144			1T3771	527
1T3569DA	144			1T3772	527
1T3569EL	144				

INDEX FOR CODE

COD.	PAG.	COD.	PAG.	COD.	PAG.
1T3781	314	1T4117DA	199	1T4195	523
1T3783	314	1T4117EL	199	1T4197	271
1T3935	217	1T4118D	200	1T4197DA	271
1T3936	217	1T4118DA	200	1T4198	271
1T3937	215	1T4118EL	200	1T4198DA	271
1T3938	215	1T4119D	200	1T4199	271
1T3939	216	1T4119DA	200	1T4199DA	271
1T3940	216	1T4119EL	200	1T4201	271
1T3966	321	1T4120D	199	1T4201DA	271
1T3978	491, 492, 511	1T4120DA	199	1T4202	271
1T3979	511	1T4120EL	199	1T4202DA	271
1T3980	511	1T4121D	199	1T4203	271
1T3985	511	1T4121DA	199	1T4203DA	271
1T3986	511	1T4121EL	199	1T4213	113, 115, 116, 117, 118, 138, 140, 141
1T3991	511	1T4122D	200	1T4215D	671
1T3992	511	1T4122DA	200	1T4215DA	671
1T3997	531	1T4122EL	200	1T4215EL	671
1T3998	531	1T4123D	200	1T4216DA	205
1T3999	531	1T4123DA	200	1T4216EL	205
1T4002	534	1T4123EL	200	1T4217DA	205
1T4003	535	1T4124D	199	1T4217EL	205
1T4004	535	1T4124DA	199	1T4218DA	205
1T4005	541	1T4124EL	199	1T4218EL	205
1T4006	541	1T4125D	200	1T4219DA	205
1T4049	490	1T4125DA	200	1T4219EL	205
1T4050	490	1T4125EL	200	1T4220DA	205
1T4051	490	1T4126D	200	1T4220EL	205
1T4052	490	1T4126DA	200	1T4221DA	205
1T4053	491	1T4126EL	200	1T4221EL	205
1T4054	491	1T4127D	199	1T4222DA	205
1T4055	492	1T4127DA	199	1T4222EL	205
1T4056	492	1T4127EL	199	1T4223DA	205
1T4061	495	1T4128D	200	1T4223EL	205
1T4062	495	1T4128DA	200	1T4224DA	206
1T4063	458	1T4128EL	200	1T4224EL	206
1T4065	458	1T4129D	200	1T4225DA	206
1T4067	458	1T4129DA	200	1T4225EL	206
1T4069	458	1T4129EL	200	1T4226DA	206
1T4071	458	1T4170	525	1T4226EL	206
1T4072	458	1T4171	525	1T4227DA	206
1T4075	458	1T4172	525	1T4227EL	206
1T4076	513	1T4173	525	1T4228DA	205
1T4077	513	1T4174	525	1T4228EL	205
1T4082	513	1T4175	525	1T4229DA	205
1T4083	513	1T4176	525	1T4229EL	205
1T4088	513	1T4177	525	1T4230DA	205
1T4089	513	1T4178	469	1T4230EL	205
1T4112D	199	1T4179	469	1T4231DA	205
1T4112DA	199	1T4180	469	1T4231EL	205
1T4112EL	199	1T4181	469	1T4232DA	205
1T4113D	199	1T4182	469	1T4232EL	205
1T4113DA	199	1T4183	469	1T4233DA	205
1T4113EL	199	1T4184	469	1T4233EL	205
1T4114D	199	1T4185	469	1T4234DA	205
1T4114DA	199	1T4186	465	1T4234EL	205
1T4114EL	199	1T4187	465	1T4235DA	205
1T4115D	199	1T4188	465	1T4235EL	205
1T4115DA	199	1T4189	466	1T4236DA	206
1T4115EL	199	1T4190	466	1T4236EL	206
1T4116D	199	1T4191	466	1T4237DA	206
1T4116DA	199	1T4192	523	1T4237EL	206
1T4116EL	199	1T4193	523	1T4238DA	206
1T4117D	199	1T4194	523		

COD.	PAG.
1T4238EL	206
1T4239DA	206
1T4239EL	206
1T4240	458
1T4241	458
1T4242	458
1T4243	458
1T4244	458
1T4245	459
1T4246	459
1T4247	459
1T4248	459
1T4249	268
1T4249DA	268
1T4250	268
1T4250DA	268
1T4251	268
1T4251DA	268
1T4252	268
1T4252DA	268
1T4253	269
1T4253DA	269
1T4254	269
1T4254DA	269
1T4255	269
1T4255DA	269
1T4256	269
1T4256DA	269
1T4257	271
1T4257DA	271
1T4258	271
1T4258DA	271
1T4259	272
1T4259DA	272
1T4260	271
1T4260DA	271
1T4261	271
1T4261DA	271
1T4262	272
1T4262DA	272
1T4264D	139
1T4264DA	139
1T4264EL	139
1T4266D	139
1T4266DA	139
1T4266EL	139
1T4268D	139
1T4268DA	139
1T4268EL	139
1T4270D	140
1T4270DA	140
1T4270EL	140
1T4272D	147
1T4272DA	147
1T4272EL	147
1T4274D	147
1T4274DA	147
1T4274EL	147
1T4276D	147
1T4276DA	147
1T4276EL	147
1T4278D	148
1T4278DA	148

COD.	PAG.
1T4278EL	148
1T4297D	200
1T4297DA	200
1T4297EL	200
1T4298D	201
1T4298DA	201
1T4298EL	201
1T4299D	201
1T4299DA	201
1T4299EL	201
1T4300D	201
1T4300DA	201
1T4300EL	201
1T4301D	201
1T4301DA	201
1T4301EL	201
1T4302D	201
1T4302DA	201
1T4302EL	201
1T4303D	202
1T4303DA	202
1T4303EL	202
1T4304	129
1T4304DA	129
1T4305	129
1T4305DA	129
1T4322	155, 191, 207, 239, 253, 277, 322, 375
1T4324	155, 191, 207, 253, 277, 322
1T4325	191, 207, 253, 277, 322
1T4369	257
1T4370	257
1T4373	257
1T4374	257
1T4377	257
1T4378	257
1T4381	257
1T4381CA	258
1T4382	257
1T4382CA	258
1T4385	257
1T4385CA	258
1T4386	257
1T4386CA	258
1T4389	257
1T4389CA	258
1T4390	257
1T4390CA	258
1T4439CA	263
1T4440CA	263
1T4441CA	263
1T4442CA	263
1T4443CA	263
1T4444CA	263
1T4445CA	263
1T4446CA	263
1T4447CA	263
1T4448CA	263
1T4449CA	263
1T4450CA	263
1T4451	503

COD.	PAG.
1T4452	503
1T4453	503
1T4454	503
1T4455	500
1T4456	500
1T4457	500
1T4458	500
1T4459	501
1T4460	501
1T4461	501
1T4462	501
1T4463	502
1T4464	502
1T4465	504
1T4466	503
1T4467	503
1T4469	503
1T4470	503
1T4472	503
1T4473	503
1T4475	503
1T4476	503
1T4478	504
1T4479	504
1T4499	521
1T4499CA	521
1T4506	521
1T4507	521
1T4512	519
1T4513	519
1T4514	519
1T4515	519
1T4522	462
1T4523	462
1T4524	462
1T4525	462
1T4526	319
1T4527	319
1T4528	317
1T4529	317
1T4530	319
1T4531	319
1T4532	317
1T4533	317
1T4538	319
1T4539	319
1T4540	320
1T4541	317
1T4542	318
1T4543	318
1T4544	319
1T4545	319
1T4546	320
1T4547	317
1T4548	318
1T4549	318
1T4550	319
1T4551	320
1T4552	318
1T4553	318
1T4554	319
1T4555	320
1T4556	318

INDEX FOR CODE

COD.	PAG.	COD.	PAG.	COD.	PAG.
1T4557	318	1T4616	313	1T4672EL	152
1T4558	310	1T4617	313	1T4673DA	152
1T4559	310	1T4617CA	313	1T4673EL	152
1T4560	306	1T4618	320	1T4676DA	152
1T4561	307	1T4619	320	1T4676EL	152
1T4562	310	1T4619CA	320	1T4677DA	152
1T4563	310	1T4620	320	1T4677EL	152
1T4564	306	1T4621	320	1T4680DA	152
1T4565	307	1T4621CA	320	1T4680EL	152
1T4566	310	1T4622	313	1T4681DA	152
1T4567	311	1T4623	313	1T4681EL	152
1T4568	311	1T4623CA	313	1T4684DA	152
1T4569	307	1T4624	313, 320	1T4684EL	152
1T4570	307	1T4625	313, 320	1T4685DA	152
1T4571	308	1T4625CA	313, 320	1T4685EL	152
1T4572	310	1T4626	313	1T4688DA	153
1T4573	311	1T4627	313	1T4688EL	153
1T4574	311	1T4627CA	313	1T4689DA	153
1T4575	307	1T4628	313, 320	1T4689EL	153
1T4576	307	1T4629	313, 320	1T4692DA	153
1T4577	308	1T4630	321	1T4692EL	153
1T4578	310	1T4631	321	1T4693DA	153
1T4579	311	1T4632	298	1T4693EL	153
1T4580	311	1T4633	298	1T4696	125, 153, 157
1T4581	307	1T4634	298	1T4697	125, 153, 157
1T4582	308	1T4635	298	1T4698	125, 153, 157
1T4583	308	1T4636	298	1T4699	125, 153, 157
1T4584	310	1T4637	298	1T4700	157
1T4585	311	1T4638	299	1T4701	157
1T4586	311	1T4639	299	1T4702	153, 157
1T4587	307	1T4640	299	1T4703	153, 157
1T4588	308	1T4641	299	1T4704	125, 153, 157
1T4589	308	1T4642	299	1T4705	125, 153, 157
1T4590	311	1T4643	299	1T4706	154, 157
1T4591	312	1T4644DA	151	1T4707	154, 157
1T4592	308	1T4644EL	151	1T4710	154, 157
1T4593	308	1T4645DA	151	1T4711	154, 157
1T4594	311	1T4645EL	151	1T4714	153, 157
1T4595	312	1T4648DA	151	1T4715	153, 157
1T4596	308	1T4648EL	151	1T4716	153, 157
1T4597	308	1T4649DA	151	1T4717	153, 157
1T4598	311	1T4649EL	151	1T4721	154, 190, 207, 240, 252, 276, 321, 375
1T4599	312	1T4652DA	151	1T4722	318
1T4600	308	1T4652EL	151	1T4723	314
1T4601	309	1T4653DA	151	1T4724	317
1T4602	311	1T4653EL	151	1T4725	314
1T4603	312	1T4656DA	151	1T4726	318
1T4604	308	1T4656EL	151	1T4728	317
1T4605	309	1T4657DA	151	1T4754DA	211
1T4606	313, 320	1T4657EL	151	1T4754EL	211
1T4607	313, 320	1T4660DA	151	1T4755DA	211
1T4608	320	1T4660EL	151	1T4755EL	211
1T4609	320	1T4661DA	151	1T4756DA	211
1T4609CA	320	1T4661EL	151	1T4756EL	211
1T4610	320	1T4664DA	151	1T4757DA	211
1T4611	320	1T4664EL	151	1T4757EL	211
1T4611CA	320	1T4665DA	151	1T4758DA	211
1T4612	313	1T4665EL	151	1T4758EL	211
1T4613	313	1T4668DA	152	1T4759DA	211
1T4613CA	313	1T4668EL	152	1T4759EL	211
1T4614	313, 320	1T4669DA	152	1T4760DA	211
1T4615	313, 320	1T4669EL	152	1T4760EL	211
1T4615CA	313, 320	1T4672DA	152		

COD.	PAG.	COD.	PAG.	COD.	PAG.
1T4761DA	211	1T4802D	136	1T4824DA	124
1T4761EL	211	1T4802DA	136	1T4824EL	124
1T4762EL	507	1T4802EL	136	1T4825DA	124
1T4763EL	507	1T4803D	144	1T4825EL	124
1T4764EL	507	1T4803DA	144	1T4826DA	124
1T4765EL	507	1T4803EL	144	1T4826EL	124
1T4766EL	507	1T4804D	144	1T4827DA	124
1T4767EL	507	1T4804DA	144	1T4827EL	124
1T4768EL	507	1T4804EL	144	1T4828DA	124
1T4769EL	507	1T4805D	136	1T4828EL	124
1T4770DA	213	1T4805DA	136	1T4838D	141
1T4770EL	213	1T4805EL	136	1T4838DA	141
1T4771DA	213	1T4806D	138	1T4838EL	141
1T4771EL	213	1T4806DA	138	1T4839D	141
1T4772DA	213	1T4806EL	138	1T4839DA	141
1T4772EL	213	1T4807D	144	1T4839EL	141
1T4773DA	213	1T4807DA	144	1T4840D	141
1T4773EL	213	1T4807EL	144	1T4840DA	141
1T4774DA	213	1T4808D	146	1T4840EL	141
1T4774EL	213	1T4808DA	146	1T4841D	141
1T4775DA	213	1T4808EL	146	1T4841DA	141
1T4775EL	213	1T4809D	146	1T4841EL	141
1T4776DA	213	1T4809DA	146	1T4878	257
1T4776EL	213	1T4809EL	146	1T4879	257
1T4777DA	213	1T4810D	146	1T4880	257
1T4777EL	213	1T4810DA	146	1T4881	257
1T4781	309	1T4810EL	146	1T4882	257
1T4782	309	1T4811D	136	1T4883	257
1T4783	309	1T4811DA	136	1T4884	257
1T4784	309	1T4811EL	136	1T4885	257
1T4785	306	1T4812D	136	1T4886	257
1T4786	306	1T4812DA	136	1T4887	257
1T4787	306	1T4812EL	136	1T4888	257
1T4788	306	1T4813D	144	1T4889	257
1T4791D	200	1T4813DA	144	1T4890	257
1T4791DA	200	1T4813EL	144	1T4891	257
1T4791EL	200	1T4814D	144	1T4892	257
1T4792D	201	1T4814DA	144	1T4893	257
1T4792DA	201	1T4814EL	144	1T4894	257
1T4792EL	201	1T4815D	136	1T4895	257
1T4793DA	205	1T4815DA	136	1T4896	257
1T4793EL	205	1T4815EL	136	1T4896CA	258
1T4794DA	205	1T4816D	138	1T4897	257
1T4794EL	205	1T4816DA	138	1T4897CA	258
1T4795DA	205	1T4816EL	138	1T4898	257
1T4795EL	205	1T4817D	144	1T4898CA	258
1T4796DA	205	1T4817DA	144	1T4899	257
1T4796EL	205	1T4817EL	144	1T4899CA	258
1T4797D	138	1T4818D	146	1T4900	257
1T4797DA	138	1T4818DA	146	1T4900CA	258
1T4797EL	138	1T4818EL	146	1T4901	257
1T4798D	138	1T4819D	138	1T4901CA	258
1T4798DA	138	1T4819DA	138	1T4926DA	187
1T4798EL	138	1T4819EL	138	1T4926EL	187
1T4799D	146	1T4820D	138	1T4927DA	187
1T4799DA	146	1T4820DA	138	1T4927EL	187
1T4799EL	146	1T4820EL	138	1T4928DA	187
1T4800D	146	1T4821DA	124	1T4928EL	187
1T4800DA	146	1T4821EL	124	1T4929DA	187
1T4800EL	146	1T4822DA	124	1T4929EL	187
1T4801D	136	1T4822EL	124	1T4930DA	187
1T4801DA	136	1T4823DA	124	1T4930EL	187
1T4801EL	136	1T4823EL	124	1T4931DA	187

INDEX FOR CODE

COD.	PAG.	COD.	PAG.	COD.	PAG.
1T4931EL	187	1T5019DA	251	1T5050EL	244
1T4932DA	187	1T5019EL	250	1T5051DA	244
1T4932EL	187	1T5020DA	251	1T5051EL	244
1T4933DA	187	1T5020EL	250	1T5052DA	244
1T4933EL	187	1T5021DA	251	1T5052EL	244
1T4934DA	187	1T5021EL	250	1T5053DA	244
1T4934EL	187	1T5022DA	251	1T5053EL	244
1T4935DA	187	1T5022EL	250	1T5054DA	244
1T4935EL	187	1T5023DA	251	1T5054EL	244
1T4936DA	187	1T5023EL	250	1T5055DA	244
1T4936EL	187	1T5024DA	252	1T5055EL	244
1T4937DA	187	1T5024EL	250	1T5056DA	244
1T4937EL	187	1T5025DA	252	1T5056EL	244
1T4938DA	187	1T5025EL	250	1T5057DA	244
1T4938EL	187	1T5026DA	252	1T5057EL	244
1T4939DA	187	1T5026EL	251	1T5058DA	244
1T4939EL	187	1T5027DA	252	1T5058EL	244
1T4940DA	187	1T5027EL	251	1T5059DA	245
1T4940EL	187	1T5028DA	251	1T5059EL	245
1T4941DA	187	1T5028EL	250	1T5060DA	244
1T4941EL	187	1T5029DA	251	1T5060EL	244
1T4942DA	187	1T5029EL	250	1T5061DA	245
1T4942EL	187	1T5030DA	252	1T5061EL	245
1T4943DA	187	1T5030EL	250	1T5062DA	245
1T4943EL	187	1T5031DA	252	1T5062EL	245
1T4944DA	188	1T5031EL	250	1T5063DA	245
1T4944EL	188	1T5032DA	252	1T5063EL	245
1T4945DA	188	1T5032EL	251	1T5064DA	245
1T4945EL	188	1T5033DA	252	1T5064EL	245
1T4946DA	188	1T5033EL	251	1T5065DA	245
1T4946EL	188	1T5034DA	244	1T5065EL	245
1T4947DA	188	1T5034EL	244	1T5066DA	245
1T4947EL	188	1T5035DA	244	1T5066EL	245
1T4948DA	187	1T5035EL	244	1T5067DA	245
1T4948EL	187	1T5036DA	244	1T5067EL	245
1T4949DA	187	1T5036EL	244	1T5068DA	245
1T4949EL	187	1T5037DA	244	1T5068EL	245
1T4950DA	188	1T5037EL	244	1T5069DA	245
1T4950EL	188	1T5038DA	244	1T5069EL	245
1T4951DA	188	1T5038EL	244	1T5070DA	245
1T4951EL	188	1T5039DA	244	1T5070EL	245
1T4952DA	188	1T5039EL	244	1T5071DA	246
1T4952EL	188	1T5040DA	244	1T5071EL	246
1T4953DA	188	1T5040EL	244	1T5072DA	245
1T4953EL	188	1T5041DA	244	1T5072EL	245
1T5010DA	251	1T5041EL	244	1T5073DA	246
1T5010EL	250	1T5042DA	244	1T5073EL	246
1T5011DA	251	1T5042EL	244	1T5074DA	246
1T5011EL	250	1T5043DA	245	1T5074EL	246
1T5012DA	251	1T5043EL	245	1T5075DA	246
1T5012EL	250	1T5044DA	244	1T5075EL	246
1T5013DA	251	1T5044EL	244	1T5076DA	246
1T5013EL	250	1T5045DA	245	1T5076EL	246
1T5014DA	251	1T5045EL	245	1T5077DA	246
1T5014EL	250	1T5046DA	245	1T5077EL	246
1T5015DA	251	1T5046EL	245	1T5078DA	246
1T5015EL	250	1T5047DA	245	1T5078EL	246
1T5016DA	251	1T5047EL	245	1T5079DA	246
1T5016EL	250	1T5048DA	245	1T5079EL	246
1T5017DA	251	1T5048EL	245	1T5080DA	246
1T5017EL	250	1T5049DA	245	1T5080EL	246
1T5018DA	251	1T5049EL	245	1T5081DA	246
1T5018EL	250	1T5050DA	244	1T5081EL	246

COD.	PAG.	COD.	PAG.	COD.	PAG.
1T5082DA	245	1T5113EL	179	1T5145DA	180
1T5082EL	245	1T5114DA	178	1T5145EL	180
1T5083DA	245	1T5114EL	178	1T5146DA	179
1T5083EL	245	1T5115DA	178	1T5146EL	179
1T5084DA	245	1T5115EL	178	1T5147DA	179
1T5084EL	245	1T5116DA	178	1T5147EL	179
1T5085DA	245	1T5116EL	178	1T5148DA	179
1T5085EL	245	1T5117DA	178	1T5148EL	179
1T5086DA	245	1T5117EL	178	1T5149DA	179
1T5086EL	245	1T5118DA	178	1T5149EL	179
1T5087DA	246	1T5118EL	178	1T5150DA	179
1T5087EL	246	1T5119DA	178	1T5150EL	179
1T5088DA	245	1T5119EL	178	1T5151DA	180
1T5088EL	245	1T5120DA	178	1T5151EL	180
1T5089DA	246	1T5120EL	178	1T5152DA	179
1T5089EL	246	1T5121DA	178	1T5152EL	179
1T5090DA	246	1T5121EL	178	1T5153DA	180
1T5090EL	246	1T5122DA	178	1T5153EL	180
1T5091DA	246	1T5122EL	178	1T5154DA	180
1T5091EL	246	1T5123DA	179	1T5154EL	180
1T5092DA	246	1T5123EL	179	1T5155DA	180
1T5092EL	246	1T5124DA	178	1T5155EL	180
1T5093DA	246	1T5124EL	178	1T5156DA	180
1T5093EL	246	1T5125DA	179	1T5156EL	180
1T5094DA	246	1T5125EL	179	1T5157DA	180
1T5094EL	246	1T5126DA	179	1T5157EL	180
1T5095DA	246	1T5126EL	179	1T5158DA	180
1T5095EL	246	1T5127DA	179	1T5158EL	180
1T5096DA	246	1T5127EL	179	1T5159DA	180
1T5096EL	246	1T5128DA	179	1T5159EL	180
1T5097DA	246	1T5128EL	179	1T5160DA	180
1T5097EL	246	1T5129DA	179	1T5160EL	180
1T5098DA	178	1T5129EL	179	1T5161DA	180
1T5098EL	178	1T5130DA	179	1T5161EL	180
1T5099DA	178	1T5130EL	179	1T5242	125, 155, 157
1T5099EL	178	1T5131DA	179	1T5243	125, 155, 157
1T5100DA	178	1T5131EL	179	1T5244	125, 155, 157
1T5100EL	178	1T5132DA	179	1T5295D	671
1T5101DA	178	1T5132EL	179	1T5295DA	671
1T5101EL	178	1T5133DA	179	1T5295EL	167, 172, 671
1T5102DA	178	1T5133EL	179	1T5296	319
1T5102EL	178	1T5134DA	179	1T5297	319
1T5103DA	178	1T5134EL	179	1T5298	317
1T5103EL	178	1T5135DA	180	1T5299	317
1T5104DA	178	1T5135EL	180	1T5300	310
1T5104EL	178	1T5136DA	179	1T5301	310
1T5105DA	178	1T5136EL	179	1T5302	307
1T5105EL	178	1T5137DA	180	1T5303	307
1T5106DA	178	1T5137EL	180	1T5304	310
1T5106EL	178	1T5138DA	180	1T5305	310
1T5107DA	179	1T5138EL	180	1T5306	307
1T5107EL	179	1T5139DA	180	1T5307	307
1T5108DA	178	1T5139EL	180	1T5308	309
1T5108EL	178	1T5140DA	180	1T5309	309
1T5109DA	179	1T5140EL	180	1T5310	309
1T5109EL	179	1T5141DA	180	1T5311	309
1T5110DA	179	1T5141EL	180	1T5312	306
1T5110EL	179	1T5142DA	180	1T5313	306
1T5111DA	179	1T5142EL	180	1T5314	306
1T5111EL	179	1T5143DA	180	1T5315	306
1T5112DA	179	1T5143EL	180	1T5321	268
1T5112EL	179	1T5144DA	180	1T5321DA	268
1T5113DA	179	1T5144EL	180	1T5322	268

INDEX FOR CODE

COD.	PAG.
1T5322DA	268
1T5323	268
1T5323DA	268
1T5324	268
1T5324DA	268
1T5325	268
1T5325DA	268
1T5326	268
1T5326DA	268
1T5327	269
1T5327DA	269
1T5328	269
1T5328DA	269
1T5329	268
1T5329DA	268
1T5330	268
1T5330DA	268
1T5331	268
1T5331DA	268
1T5332	268
1T5332DA	268
1T5333	269
1T5333DA	269
1T5334	269
1T5334DA	269
1T5335	269
1T5335DA	269
1T5336	269
1T5336DA	269
1T5337	271
1T5337DA	271
1T5338	271
1T5338DA	271
1T5339	271
1T5339DA	271
1T5340	271
1T5340DA	271
1T5341	271
1T5341DA	271
1T5342	271
1T5342DA	271
1T5343	271
1T5343DA	271
1T5344	271
1T5344DA	271
1T5345	272
1T5345DA	272
1T5346	271
1T5346DA	271
1T5347	271
1T5347DA	271
1T5348	272
1T5348DA	272
1T5349	88, 92, 103, 119, 123, 125, 127, 131, 143, 150, 155, 159, 167, 172, 186, 191, 195, 204, 207, 209, 213, 291, 294, 295, 300, 316, 322, 394, 399, 407, 412, 416, 420, 422, 424, 426, 441, 447, 455, 459, 474, 486, 495, 505, 519, 521, 792

COD.	PAG.
1T5350	792
1T5351	491, 492, 509, 515, 527, 529, 535, 541, 793
1T5352	88, 92, 103, 119, 123, 125, 127, 131, 143, 150, 155, 159, 167, 172, 186, 191, 195, 204, 207, 209, 213, 234, 240, 241, 291, 294, 295, 300, 316, 322, 367, 394, 399, 407, 412, 416, 420, 422, 424, 426, 441, 447, 455, 459, 462, 474, 486, 495, 505, 519, 521, 793
1T5353DA	229
1T5353DACA	229
1T5353EL	229
1T5354DA	229
1T5354DACA	229
1T5354EL	229
1T5355DA	229
1T5355DACA	229
1T5355EL	229
1T5356DA	229
1T5356DACA	229
1T5356EL	229
1T5357DA	229
1T5357DACA	229
1T5357EL	229
1T5358DA	229
1T5358DACA	229
1T5358EL	229
1T5359DA	229
1T5359DACA	229
1T5359EL	229
1T5360DA	229
1T5360DACA	229
1T5360EL	229
1T5361DA	229
1T5361DACA	229
1T5361EL	229
1T5362DA	229
1T5362DACA	229
1T5362EL	229
1T5363DA	229
1T5363DACA	229
1T5363EL	229
1T5364DA	229
1T5364DACA	229
1T5364EL	229
1T5365DA	229
1T5365DACA	229
1T5365EL	229
1T5366DA	229
1T5366DACA	229
1T5366EL	229
1T5367DA	229
1T5367DACA	229
1T5367EL	229
1T5368DA	229
1T5368DACA	229
1T5368EL	229

COD.	PAG.
1T5369DA	230
1T5369DACA	230
1T5369EL	230
1T5370DA	230
1T5370DACA	230
1T5370EL	230
1T5371DA	230
1T5371DACA	230
1T5371EL	230
1T5372DA	230
1T5372DACA	230
1T5372EL	230
1T5373DA	230
1T5373DACA	230
1T5373EL	230
1T5374DA	230
1T5374DACA	230
1T5374EL	230
1T5375DA	230
1T5375DACA	230
1T5375EL	230
1T5376DA	230
1T5376DACA	230
1T5376EL	230
1T5377DA	226
1T5377DACA	226
1T5377EL	226
1T5378DA	226
1T5378DACA	226
1T5378EL	226
1T5379DA	226
1T5379DACA	226
1T5379EL	226
1T5380DA	226
1T5380DACA	226
1T5380EL	226
1T5381DA	226
1T5381DACA	226
1T5381EL	226
1T5382DA	226
1T5382DACA	226
1T5382EL	226
1T5383DA	226
1T5383DACA	226
1T5383EL	226
1T5384DA	226
1T5384DACA	226
1T5384EL	226
1T5385DA	226
1T5385DACA	226
1T5385EL	226
1T5386DA	226
1T5386DACA	226
1T5386EL	226
1T5387DA	226
1T5387DACA	226
1T5387EL	226
1T5388DA	226
1T5388DACA	226
1T5388EL	226
1T5389DA	226
1T5389DACA	226
1T5389EL	226

COD.	PAG.	COD.	PAG.	COD.	PAG.
1T5390DA	226	1T5432EL	89	1T5464DA	402
1T5390DACA	226	1T5433DA	89	1T5464EL	402
1T5390EL	226	1T5433EL	89	1T5465DA	402
1T5391DA	226	1T5434DA	89	1T5465EL	402
1T5391DACA	226	1T5434EL	89	1T5466DA	402
1T5391EL	226	1T5435DA	89	1T5466EL	402
1T5392DA	226	1T5435EL	89	1T5467DA	402
1T5392DACA	226	1T5436DA	89	1T5467EL	402
1T5392EL	226	1T5436EL	89	1T5468DA	402
1T5393DA	227	1T5437DA	89	1T5468EL	402
1T5393DACA	227	1T5437EL	89	1T5469DA	402
1T5393EL	227	1T5438DA	89	1T5469EL	402
1T5394DA	227	1T5438EL	89	1T5470DA	402
1T5394DACA	227	1T5439DA	89	1T5470EL	402
1T5394EL	227	1T5439EL	89	1T5471DA	403
1T5395DA	227	1T5440DA	89	1T5471EL	403
1T5395DACA	227	1T5440EL	89	1T5472DA	403
1T5395EL	227	1T5441DA	90	1T5472EL	403
1T5396DA	227	1T5441EL	90	1T5473DA	403
1T5396DACA	227	1T5442DA	90	1T5473EL	403
1T5396EL	227	1T5442EL	90	1T5474DA	403
1T5397DA	227	1T5443DA	90	1T5474EL	403
1T5397DACA	227	1T5443EL	90	1T5475DA	403
1T5397EL	227	1T5444DA	90	1T5475EL	403
1T5398DA	227	1T5444EL	90	1T5476DA	403
1T5398DACA	227	1T5445DA	90	1T5476EL	403
1T5398EL	227	1T5445EL	90	1T5477DA	403
1T5399DA	227	1T5446DA	90	1T5477EL	403
1T5399DACA	227	1T5446EL	90	1T5478DA	403
1T5399EL	227	1T5447DA	90	1T5478EL	403
1T5400DA	227	1T5447EL	90	1T5479DA	403
1T5400DACA	227	1T5448DA	90	1T5479EL	403
1T5400EL	227	1T5448EL	90	1T5480DA	403
1T5406DA	211	1T5449DA	90	1T5480EL	403
1T5406EL	211	1T5449EL	90	1T5481DA	404
1T5407DA	211	1T5450DA	90	1T5481EL	404
1T5407EL	211	1T5450EL	90	1T5482DA	404
1T5408DA	211	1T5451DA	91	1T5482EL	404
1T5408EL	211	1T5451EL	91	1T5483DA	404
1T5409DA	211	1T5452DA	91	1T5483EL	404
1T5409EL	211	1T5452EL	91	1T5484DA	404
1T5410DA	211	1T5453DA	91	1T5484EL	404
1T5410EL	211	1T5453EL	91	1T5485DA	404
1T5411DA	211	1T5454DA	91	1T5485EL	404
1T5411EL	211	1T5454EL	91	1T5486DA	404
1T5412DA	211	1T5455DA	91	1T5486EL	404
1T5412EL	211	1T5455EL	91	1T5487DA	404
1T5413DA	211	1T5456DA	91	1T5487EL	404
1T5413EL	211	1T5456EL	91	1T5488DA	404
1T5414EL	507	1T5457DA	91	1T5488EL	404
1T5415EL	507	1T5457EL	91	1T5489DA	404
1T5416EL	507	1T5458DA	91	1T5489EL	404
1T5417EL	507	1T5458EL	91	1T5490DA	404
1T5418EL	507	1T5459DA	92	1T5490EL	404
1T5419EL	507	1T5459EL	92	1T5491DA	450
1T5420EL	507	1T5460DA	92	1T5491EL	450
1T5421EL	507	1T5460EL	92	1T5492DA	450
1T5422	217	1T5461DA	402	1T5492EL	450
1T5423	217	1T5461EL	402	1T5493DA	450
1T5430	492, 511	1T5462DA	402	1T5493EL	450
1T5431DA	89	1T5462EL	402	1T5494DA	450
1T5431EL	89	1T5463DA	402	1T5494EL	450
1T5432DA	89	1T5463EL	402	1T5495DA	450

INDEX FOR CODE

COD.	PAG.	COD.	PAG.	COD.	PAG.
1T5495EL	450	1T5527DA	450	1T5558EL	452
1T5496DA	450	1T5527EL	450	1T5559DA	452
1T5496EL	450	1T5528DA	450	1T5559EL	452
1T5497DA	450	1T5528EL	450	1T5560DA	452
1T5497EL	450	1T5529DA	450	1T5560EL	452
1T5498DA	450	1T5529EL	450	1T5561DA	452
1T5498EL	450	1T5530DA	450	1T5561EL	452
1T5499DA	450	1T5530EL	450	1T5562DA	452
1T5499EL	450	1T5531DA	450	1T5562EL	452
1T5500DA	450	1T5531EL	450	1T5563DA	452
1T5500EL	450	1T5532DA	450	1T5563EL	452
1T5501DA	450	1T5532EL	450	1T5564DA	452
1T5501EL	450	1T5533DA	450	1T5564EL	452
1T5502DA	450	1T5533EL	450	1T5565DA	452
1T5502EL	450	1T5534DA	450	1T5565EL	452
1T5503DA	451	1T5534EL	450	1T5566DA	452
1T5503EL	451	1T5535DA	450	1T5566EL	452
1T5504DA	451	1T5535EL	450	1T5567DA	452
1T5504EL	451	1T5536DA	450	1T5567EL	452
1T5505DA	451	1T5536EL	450	1T5568DA	452
1T5505EL	451	1T5537DA	450	1T5568EL	452
1T5506DA	451	1T5537EL	450	1T5569DA	452
1T5506EL	451	1T5538DA	450	1T5569EL	452
1T5507DA	451	1T5538EL	450	1T5570DA	452
1T5507EL	451	1T5539DA	451	1T5570EL	452
1T5508DA	451	1T5539EL	451	1T5571DA	452
1T5508EL	451	1T5540DA	451	1T5571EL	452
1T5509DA	451	1T5540EL	451	1T5572DA	452
1T5509EL	451	1T5541DA	451	1T5572EL	452
1T5510DA	451	1T5541EL	451	1T5573DA	452
1T5510EL	451	1T5542DA	451	1T5573EL	452
1T5511DA	451	1T5542EL	451	1T5574DA	452
1T5511EL	451	1T5543DA	451	1T5574EL	452
1T5512DA	451	1T5543EL	451	1T5575DA	452
1T5512EL	451	1T5544DA	451	1T5575EL	452
1T5513DA	451	1T5544EL	451	1T5576DA	452
1T5513EL	451	1T5545DA	451	1T5576EL	452
1T5514DA	451	1T5545EL	451	1T5577DA	452
1T5514EL	451	1T5546DA	451	1T5577EL	452
1T5515DA	450	1T5546EL	451	1T5578DA	452
1T5515EL	450	1T5547DA	451	1T5578EL	452
1T5516DA	450	1T5547EL	451	1T5579DA	452
1T5516EL	450	1T5548DA	451	1T5579EL	452
1T5517DA	450	1T5548EL	451	1T5580DA	452
1T5517EL	450	1T5549DA	451	1T5580EL	452
1T5518DA	450	1T5549EL	451	1T5581DA	452
1T5518EL	450	1T5550DA	451	1T5581EL	452
1T5519DA	450	1T5550EL	451	1T5582DA	452
1T5519EL	450	1T5551DA	452	1T5582EL	452
1T5520DA	450	1T5551EL	452	1T5583DA	452
1T5520EL	450	1T5552DA	452	1T5583EL	452
1T5521DA	451	1T5552EL	452	1T5584DA	452
1T5521EL	451	1T5553DA	452	1T5584EL	452
1T5522DA	451	1T5553EL	452	1T5585DA	452
1T5522EL	451	1T5554DA	452	1T5585EL	452
1T5523DA	451	1T5554EL	452	1T5586DA	452
1T5523EL	451	1T5555DA	452	1T5586EL	452
1T5524DA	451	1T5555EL	452	1T5587DA	453
1T5524EL	451	1T5556DA	452	1T5587EL	453
1T5525DA	451	1T5556EL	452	1T5588DA	453
1T5525EL	451	1T5557DA	452	1T5588EL	453
1T5526DA	451	1T5557EL	452	1T5589DA	453
1T5526EL	451	1T5558DA	452	1T5589EL	453

COD.	PAG.
1T5590DA	453
1T5590EL	453
1T5591DA	453
1T5591EL	453
1T5592DA	453
1T5592EL	453
1T5593DA	453
1T5593EL	453
1T5594DA	453
1T5594EL	453
1T5595DA	453
1T5595EL	453
1T5596DA	453
1T5596EL	453
1T5597DA	453
1T5597EL	453
1T5598DA	453
1T5598EL	453
1T5599DA	454
1T5599EL	454
1T5600DA	454
1T5600EL	454
1T5601DA	454
1T5601EL	454
1T5602DA	454
1T5602EL	454
1T5603DA	454
1T5603EL	454
1T5604DA	454
1T5604EL	454
1T5605DA	454
1T5605EL	454
1T5606DA	454
1T5606EL	454
1T5607DA	454
1T5607EL	454
1T5608DA	454
1T5608EL	454
1T5609DA	454
1T5609EL	454
1T5610DA	454
1T5610EL	454
1T5611DA	453
1T5611EL	453
1T5612DA	453
1T5612EL	453
1T5613DA	453
1T5613EL	453
1T5614DA	453
1T5614EL	453
1T5615DA	453
1T5615EL	453
1T5616DA	453
1T5616EL	453
1T5617DA	454
1T5617EL	454
1T5618DA	454
1T5618EL	454
1T5619DA	454
1T5619EL	454
1T5620DA	454
1T5620EL	454
1T5621DA	454

COD.	PAG.
1T5621EL	454
1T5622DA	454
1T5622EL	454
1T5623DA	453
1T5623EL	453
1T5624DA	453
1T5624EL	453
1T5625DA	453
1T5625EL	453
1T5626DA	453
1T5626EL	453
1T5627DA	453
1T5627EL	453
1T5628DA	453
1T5628EL	453
1T5629DA	453
1T5629EL	453
1T5630DA	453
1T5630EL	453
1T5631DA	453
1T5631EL	453
1T5632DA	453
1T5632EL	453
1T5633DA	453
1T5633EL	453
1T5634DA	453
1T5634EL	453
1T5635DA	385
1T5635EL	385
1T5636DA	385
1T5636EL	385
1T5637DA	385
1T5637EL	385
1T5638DA	385
1T5638EL	385
1T5639DA	385
1T5639EL	385
1T5640DA	385
1T5640EL	385
1T5641DA	385
1T5641EL	385
1T5642DA	385
1T5642EL	385
1T5643DA	385
1T5643EL	385
1T5644DA	385
1T5644EL	385
1T5645DA	385
1T5645EL	385
1T5646DA	385
1T5646EL	385
1T5647DA	386
1T5647EL	386
1T5648DA	386
1T5648EL	386
1T5649DA	386
1T5649EL	386
1T5650DA	386
1T5650EL	386
1T5651DA	386
1T5651EL	386
1T5652DA	386
1T5652EL	386

COD.	PAG.
1T5653DA	386
1T5653EL	386
1T5654DA	386
1T5654EL	386
1T5655DA	386
1T5655EL	386
1T5656DA	386
1T5656EL	386
1T5657DA	386
1T5657EL	386
1T5658DA	386
1T5658EL	386
1T5659DA	386
1T5659EL	386
1T5660DA	386
1T5660EL	386
1T5661DA	386
1T5661EL	386
1T5662DA	386
1T5662EL	386
1T5663DA	386
1T5663EL	386
1T5664DA	386
1T5664EL	386
1T5665DA	386
1T5665EL	386
1T5666DA	386
1T5666EL	386
1T5667DA	386
1T5667EL	386
1T5668DA	386
1T5668EL	386
1T5669DA	386
1T5669EL	386
1T5670DA	386
1T5670EL	386
1T5671DA	386
1T5671EL	386
1T5672DA	386
1T5672EL	386
1T5673DA	386
1T5673EL	386
1T5674DA	386
1T5674EL	386
1T5675DA	386
1T5675EL	386
1T5676DA	386
1T5676EL	386
1T5677DA	386
1T5677EL	386
1T5678DA	386
1T5678EL	386
1T5679DA	386
1T5679EL	386
1T5680DA	386
1T5680EL	386
1T5681DA	386
1T5681EL	386
1T5682DA	386
1T5682EL	386
1T5683DA	387
1T5683EL	387
1T5684DA	387

INDEX FOR CODE

COD.	PAG.	COD.	PAG.	COD.	PAG.
1T5684EL	387	1T5716DA	388	1T5747EL	389
1T5685DA	387	1T5716EL	388	1T5748DA	389
1T5685EL	387	1T5717DA	388	1T5748EL	389
1T5686DA	387	1T5717EL	388	1T5749DA	389
1T5686EL	387	1T5718DA	388	1T5749EL	389
1T5687DA	387	1T5718EL	388	1T5750DA	389
1T5687EL	387	1T5719DA	387	1T5750EL	389
1T5688DA	387	1T5719EL	387	1T5751DA	389
1T5688EL	387	1T5720DA	387	1T5751EL	389
1T5689DA	387	1T5720EL	387	1T5752DA	389
1T5689EL	387	1T5721DA	387	1T5752EL	389
1T5690DA	387	1T5721EL	387	1T5753DA	389
1T5690EL	387	1T5722DA	387	1T5753EL	389
1T5691DA	387	1T5722EL	387	1T5754DA	389
1T5691EL	387	1T5723DA	387	1T5754EL	389
1T5692DA	387	1T5723EL	387	1T5755DA	389
1T5692EL	387	1T5724DA	387	1T5755EL	389
1T5693DA	387	1T5724EL	387	1T5756DA	389
1T5693EL	387	1T5725DA	387	1T5756EL	389
1T5694DA	387	1T5725EL	387	1T5757DA	389
1T5694EL	387	1T5726DA	387	1T5757EL	389
1T5695DA	388	1T5726EL	387	1T5758DA	389
1T5695EL	388	1T5727DA	387	1T5758EL	389
1T5696DA	388	1T5727EL	387	1T5759DA	389
1T5696EL	388	1T5728DA	387	1T5759EL	389
1T5697DA	388	1T5728EL	387	1T5760DA	389
1T5697EL	388	1T5729DA	387	1T5760EL	389
1T5698DA	388	1T5729EL	387	1T5761DA	389
1T5698EL	388	1T5730DA	387	1T5761EL	389
1T5699DA	388	1T5730EL	387	1T5762DA	389
1T5699EL	388	1T5731DA	388	1T5762EL	389
1T5700DA	388	1T5731EL	388	1T5763DA	389
1T5700EL	388	1T5732DA	388	1T5763EL	389
1T5701DA	388	1T5732EL	388	1T5764DA	389
1T5701EL	388	1T5733DA	388	1T5764EL	389
1T5702DA	388	1T5733EL	388	1T5765DA	389
1T5702EL	388	1T5734DA	388	1T5765EL	389
1T5703DA	388	1T5734EL	388	1T5766DA	389
1T5703EL	388	1T5735DA	388	1T5766EL	389
1T5704DA	388	1T5735EL	388	1T5767DA	389
1T5704EL	388	1T5736DA	388	1T5767EL	389
1T5705DA	388	1T5736EL	388	1T5768DA	389
1T5705EL	388	1T5737DA	388	1T5768EL	389
1T5706DA	388	1T5737EL	388	1T5769DA	389
1T5706EL	388	1T5738DA	388	1T5769EL	389
1T5707DA	387	1T5738EL	388	1T5770DA	389
1T5707EL	387	1T5739DA	388	1T5770EL	389
1T5708DA	387	1T5739EL	388	1T5771DA	389
1T5708EL	387	1T5740DA	388	1T5771EL	389
1T5709DA	387	1T5740EL	388	1T5772DA	389
1T5709EL	387	1T5741DA	388	1T5772EL	389
1T5710DA	387	1T5741EL	388	1T5773DA	389
1T5710EL	387	1T5742DA	388	1T5773EL	389
1T5711DA	387	1T5742EL	388	1T5774DA	389
1T5711EL	387	1T5743DA	389	1T5774EL	389
1T5712DA	387	1T5743EL	389	1T5775DA	389
1T5712EL	387	1T5744DA	389	1T5775EL	389
1T5713DA	388	1T5744EL	389	1T5776DA	389
1T5713EL	388	1T5745DA	389	1T5776EL	389
1T5714DA	388	1T5745EL	389	1T5777DA	389
1T5714EL	388	1T5746DA	389	1T5777EL	389
1T5715DA	388	1T5746EL	389	1T5778DA	389
1T5715EL	388	1T5747DA	389	1T5778EL	389

COD.	PAG.	COD.	PAG.	COD.	PAG.
1T5779DA	85	1T5810EL	86	1T5842DA	396
1T5779EL	85	1T5811DA	86	1T5842EL	396
1T5780DA	85	1T5811EL	86	1T5843DA	396
1T5780EL	85	1T5812DA	86	1T5843EL	396
1T5781DA	85	1T5812EL	86	1T5844DA	396
1T5781EL	85	1T5813DA	86	1T5844EL	396
1T5782DA	85	1T5813EL	86	1T5845DA	396
1T5782EL	85	1T5814DA	86	1T5845EL	396
1T5783DA	85	1T5814EL	86	1T5846DA	396
1T5783EL	85	1T5815DA	86	1T5846EL	396
1T5784DA	85	1T5815EL	86	1T5847DA	396
1T5784EL	85	1T5816DA	86	1T5847EL	396
1T5785DA	85	1T5816EL	86	1T5848DA	396
1T5785EL	85	1T5817DA	86	1T5848EL	396
1T5786DA	85	1T5817EL	86	1T5849DA	396
1T5786EL	85	1T5818DA	86	1T5849EL	396
1T5787DA	85	1T5818EL	86	1T5850DA	396
1T5787EL	85	1T5819DA	87	1T5850EL	396
1T5788DA	85	1T5819EL	87	1T5851DA	396
1T5788EL	85	1T5820DA	87	1T5851EL	396
1T5789DA	85	1T5820EL	87	1T5852DA	396
1T5789EL	85	1T5821DA	87	1T5852EL	396
1T5790DA	85	1T5821EL	87	1T5853DA	396
1T5790EL	85	1T5822DA	87	1T5853EL	396
1T5791DA	85	1T5822EL	87	1T5854DA	396
1T5791EL	85	1T5823DA	87	1T5854EL	396
1T5792DA	85	1T5823EL	87	1T5855DA	396
1T5792EL	85	1T5824DA	87	1T5855EL	396
1T5793DA	85	1T5824EL	87	1T5856DA	396
1T5793EL	85	1T5825DA	87	1T5856EL	396
1T5794DA	85	1T5825EL	87	1T5857DA	396
1T5794EL	85	1T5826DA	87	1T5857EL	396
1T5795DA	85	1T5826EL	87	1T5858DA	396
1T5795EL	85	1T5827DA	87	1T5858EL	396
1T5796DA	85	1T5827EL	87	1T5859DA	397
1T5796EL	85	1T5828DA	87	1T5859EL	397
1T5797DA	85	1T5828EL	87	1T5860DA	397
1T5797EL	85	1T5829DA	87	1T5860EL	397
1T5798DA	85	1T5829EL	87	1T5861DA	397
1T5798EL	85	1T5830DA	87	1T5861EL	397
1T5799DA	86	1T5830EL	87	1T5862DA	397
1T5799EL	86	1T5831DA	87	1T5862EL	397
1T5800DA	86	1T5831EL	87	1T5863DA	397
1T5800EL	86	1T5832DA	87	1T5863EL	397
1T5801DA	86	1T5832EL	87	1T5864DA	397
1T5801EL	86	1T5833DA	87	1T5864EL	397
1T5802DA	86	1T5833EL	87	1T5865DA	397
1T5802EL	86	1T5834DA	87	1T5865EL	397
1T5803DA	86	1T5834EL	87	1T5866DA	397
1T5803EL	86	1T5835DA	88	1T5866EL	397
1T5804DA	86	1T5835EL	88	1T5867DA	397
1T5804EL	86	1T5836DA	88	1T5867EL	397
1T5805DA	86	1T5836EL	88	1T5868DA	397
1T5805EL	86	1T5837DA	88	1T5868EL	397
1T5806DA	86	1T5837EL	88	1T5869DA	397
1T5806EL	86	1T5838DA	88	1T5869EL	397
1T5807DA	86	1T5838EL	88	1T5870DA	397
1T5807EL	86	1T5839DA	396	1T5870EL	397
1T5808DA	86	1T5839EL	396	1T5871DA	397
1T5808EL	86	1T5840DA	396	1T5871EL	397
1T5809DA	86	1T5840EL	396	1T5872DA	397
1T5809EL	86	1T5841DA	396	1T5872EL	397
1T5810DA	86	1T5841EL	396	1T5873DA	397

INDEX FOR CODE

COD.	PAG.	COD.	PAG.	COD.	PAG.
1T5873EL	397	1T5905DA	393, 411, 422, 455	1T5956DA	189
1T5874DA	397	1T5905EL	393, 411, 422, 455	1T5956EL	189
1T5874EL	397	1T5906DA	393, 411, 422, 455	1T5957DA	189
1T5875DA	397	1T5906EL	393, 411, 422, 455	1T5957EL	189
1T5875EL	397	1T5907DA	393, 411, 422, 455	1T5958DA	189
1T5876DA	397	1T5907EL	393, 411, 422, 455	1T5958EL	189
1T5876EL	397	1T5908	407, 419, 425, 433	1T5959DA	189
1T5877DA	397			1T5959EL	189
1T5877EL	397	1T5911	394, 399, 407, 412, 416, 420, 422, 424, 426, 429, 431, 433	1T5960DA	188
1T5878DA	397			1T5960EL	188
1T5878EL	397	1T5912	393, 411, 422, 429, 454	1T5961DA	188
1T5879DA	398			1T5961EL	188
1T5879EL	398	1T5913	393, 411, 422, 429, 454	1T5962DA	188
1T5880DA	398			1T5962EL	188
1T5880EL	398	1T5914	393, 411, 422, 429, 454	1T5963DA	188
1T5881DA	398			1T5963EL	188
1T5881EL	398	1T5915	399, 416	1T5964DA	189
1T5882DA	398	1T5916	399, 416	1T5964EL	189
1T5882EL	398	1T5917	399, 416	1T5965DA	189
1T5883DA	398	1T5918	88	1T5965EL	189
1T5883EL	398	1T5919	88	1T5966DA	189
1T5884DA	398	1T5920	88	1T5966EL	189
1T5884EL	398	1T5921	399, 416	1T5967DA	189
1T5885DA	398	1T5925	156	1T5967EL	189
1T5885EL	398	1T5936	156	1T5968DA	188
1T5886DA	398			1T5968EL	188
1T5886EL	398	1T5937	393, 399, 411, 416, 421, 423, 428, 430	1T5969DA	188
1T5887DA	398			1T5969EL	188
1T5887EL	398	1T5938	393, 399, 411, 416, 421, 423, 428, 430	1T5970DA	189
1T5888DA	398			1T5970EL	189
1T5888EL	398	1T5939	393, 411, 416, 421, 428	1T5971DA	189
1T5889DA	398			1T5971EL	189
1T5889EL	398	1T5940DA	405	1T5972DA	189
1T5890DA	398	1T5940EL	405	1T5972EL	189
1T5890EL	398	1T5941DA	405	1T5973DA	189
1T5891DA	398	1T5941EL	405	1T5973EL	189
1T5891EL	398	1T5942DA	405	1T5974DA	188
1T5892DA	398	1T5942EL	405	1T5974EL	188
1T5892EL	398	1T5943DA	405	1T5975DA	188
1T5893DA	398	1T5943EL	405	1T5975EL	188
1T5893EL	398	1T5944DA	405	1T5976DA	390
1T5894DA	398	1T5944EL	405	1T5976EL	390
1T5894EL	398	1T5945DA	405	1T5977DA	390
1T5895DA	398	1T5945EL	405	1T5977EL	390
1T5895EL	398	1T5946DA	406	1T5978DA	390
1T5896DA	398	1T5946EL	406	1T5978EL	390
1T5896EL	398	1T5947DA	406	1T5979DA	390
1T5897DA	398	1T5947EL	406	1T5979EL	390
1T5897EL	398	1T5948DA	406	1T5980DA	390
1T5898DA	398	1T5948EL	406	1T5980EL	390
1T5898EL	398	1T5949DA	406	1T5981DA	390
1T5899	393, 411, 422, 429, 455	1T5949EL	406	1T5981EL	390
1T5900	393, 411, 422, 429, 455	1T5950DA	406	1T5982DA	390
1T5901	393, 411, 422, 429, 455	1T5950EL	406	1T5982EL	390
1T5902	393, 411, 422, 429, 455	1T5951DA	406	1T5983DA	390
1T5903	393, 411, 422, 429, 455	1T5951EL	406	1T5983EL	390
1T5904	393, 411, 422, 429, 455	1T5952DA	188	1T5984DA	390
		1T5952EL	188	1T5984EL	390
		1T5953DA	188	1T5985DA	390
		1T5953EL	188	1T5985EL	390
		1T5954DA	188	1T5986DA	390
		1T5954EL	188	1T5986EL	390
		1T5955DA	188	1T5987DA	390
		1T5955EL	188		

COD.	PAG.	COD.	PAG.	COD.	PAG.
1T5987EL	390	1T6020EL	395	1T6053	228
1T5988DA	391	1T6021DA	395	1T6054	227
1T5988EL	391	1T6021EL	395	1T6055	227
1T5989DA	391	1T6022DA	395	1T6056	227
1T5989EL	391	1T6022EL	395	1T6057	227
1T5990DA	391	1T6023DA	395	1T6058	228
1T5990EL	391	1T6023EL	395	1T6059	231
1T5991DA	391	1T6024DA	395	1T6060	231
1T5991EL	391	1T6024EL	395	1T6061	231
1T5992DA	391	1T6025DA	395	1T6062	231
1T5992EL	391	1T6025EL	395	1T6063	231
1T5993DA	391	1T6026DA	395	1T6064	231
1T5993EL	391	1T6026EL	395	1T6066DA	98, 480
1T5994DA	391	1T6027DA	384	1T6066EL	98, 480
1T5994EL	391	1T6027EL	384	1T6067DA	98, 480
1T5995DA	391	1T6028DA	384	1T6067EL	98, 480
1T5995EL	391	1T6028EL	384	1T6068DA	98, 480
1T5996DA	391	1T6029DA	384	1T6068EL	98, 480
1T5996EL	391	1T6029EL	384	1T6069DA	98, 480
1T5997DA	391	1T6030DA	384	1T6069EL	98, 480
1T5997EL	391	1T6030EL	384	1T6070DA	98, 480
1T5998DA	391	1T6031DA	384	1T6070EL	98, 480
1T5998EL	391	1T6031EL	384	1T6071DA	98, 480
1T5999DA	391	1T6032DA	384	1T6071EL	98, 480
1T5999EL	391	1T6032EL	384	1T6072DA	98, 480
1T6000DA	392	1T6033DA	384	1T6072EL	98, 480
1T6000EL	392	1T6033EL	384	1T6073DA	98, 480
1T6001DA	392	1T6034DA	384	1T6073EL	98, 480
1T6001EL	392	1T6034EL	384	1T6074DA	98, 480
1T6002DA	392	1T6035DA	384	1T6074EL	98, 480
1T6002EL	392	1T6035EL	384	1T6075DA	98, 480
1T6003DA	392	1T6036DA	384	1T6075EL	98, 480
1T6003EL	392	1T6036EL	384	1T6076DA	98, 480
1T6004DA	392	1T6037DA	384	1T6076EL	98, 480
1T6004EL	392	1T6037EL	384	1T6077DA	98, 480
1T6005DA	392	1T6038DA	384	1T6077EL	98, 480
1T6005EL	392	1T6038EL	384	1T6078DA	98, 481
1T6006DA	392	1T6039DA	385	1T6078EL	98, 481
1T6006EL	392	1T6039EL	385	1T6079DA	98, 481
1T6007DA	392	1T6040DA	385	1T6079EL	98, 481
1T6007EL	392	1T6040EL	385	1T6080DA	98, 481
1T6008DA	392	1T6041DA	385	1T6080EL	98, 481
1T6008EL	392	1T6041EL	385	1T6081DA	98, 481
1T6009DA	392	1T6042DA	385	1T6081EL	98, 481
1T6009EL	392	1T6042EL	385	1T6082DA	98, 481
1T6010DA	392	1T6043DA	385	1T6082EL	98, 481
1T6010EL	392	1T6043EL	385	1T6083DA	98, 481
1T6011DA	392	1T6044DA	385	1T6083EL	98, 481
1T6011EL	392	1T6044EL	385	1T6084DA	98, 481
1T6012	88	1T6045DA	385	1T6084EL	98, 481
1T6013	88	1T6045EL	385	1T6085DA	98, 481
1T6014	88	1T6046DA	385	1T6085EL	98, 481
1T6015DA	401	1T6046EL	385	1T6086DA	98, 481
1T6015EL	401	1T6047DA	385	1T6086EL	98, 481
1T6016DA	401	1T6047EL	385	1T6087DA	98, 481
1T6016EL	401	1T6048DA	385	1T6087EL	98, 481
1T6017DA	401	1T6048EL	385	1T6088DA	98, 481
1T6017EL	401	1T6049DA	385	1T6088EL	98, 481
1T6018DA	401	1T6049EL	385	1T6089DA	98, 481
1T6018EL	401	1T6050DA	385	1T6089EL	98, 481
1T6019DA	395	1T6050EL	385	1T6090DA	480
1T6019EL	395	1T6051	399, 416, 424, 431	1T6090EL	480
1T6020DA	395	1T6052	399, 416, 424, 431	1T6091DA	480

INDEX FOR CODE

COD.	PAG.	COD.	PAG.	COD.	PAG.
1T6091EL	480	1T6141DA	99, 481	1T6172EL	482
1T6092DA	480	1T6141EL	99, 481	1T6173DA	482
1T6092EL	480	1T6142DA	99, 481	1T6173EL	482
1T6093DA	480	1T6142EL	99, 481	1T6174DA	99, 482
1T6093EL	480	1T6143DA	99, 481	1T6174EL	99, 482
1T6094DA	480	1T6143EL	99, 481	1T6175DA	99, 482
1T6094EL	480	1T6144DA	99, 482	1T6175EL	99, 482
1T6095DA	480	1T6144EL	99, 482	1T6176DA	99, 482
1T6095EL	480	1T6145DA	99, 482	1T6176EL	99, 482
1T6096DA	480	1T6145EL	99, 482	1T6177DA	99, 482
1T6096EL	480	1T6146DA	99, 482	1T6177EL	99, 482
1T6097DA	480	1T6146EL	99, 482	1T6178DA	99, 482
1T6097EL	480	1T6147DA	99, 482	1T6178EL	99, 482
1T6098DA	480	1T6147EL	99, 482	1T6179DA	99, 482
1T6098EL	480	1T6148DA	99, 482	1T6179EL	99, 482
1T6099DA	480	1T6148EL	99, 482	1T6186DA	100, 483
1T6099EL	480	1T6149DA	99, 482	1T6186EL	100, 483
1T6100DA	480	1T6149EL	99, 482	1T6187DA	100, 483
1T6100EL	480	1T6150DA	100, 482	1T6187EL	100, 483
1T6101DA	480	1T6150EL	100, 482	1T6188DA	100, 483
1T6101EL	480	1T6151DA	100, 482	1T6188EL	100, 483
1T6102DA	98, 480	1T6151EL	100, 482	1T6189DA	100, 483
1T6102EL	98, 480	1T6152DA	100, 482	1T6189EL	100, 483
1T6103DA	98, 480	1T6152EL	100, 482	1T6190DA	100, 483
1T6103EL	98, 480	1T6153DA	100, 482	1T6190EL	100, 483
1T6104DA	98, 480	1T6153EL	100, 482	1T6191DA	100, 483
1T6104EL	98, 480	1T6154DA	100, 482	1T6191EL	100, 483
1T6105DA	98, 480	1T6154EL	100, 482	1T6198DA	482
1T6105EL	98, 480	1T6155DA	100, 482	1T6198EL	482
1T6106DA	98, 480	1T6155EL	100, 482	1T6199DA	482
1T6106EL	98, 480	1T6156DA	100, 483	1T6199EL	482
1T6107DA	98, 480	1T6156EL	100, 483	1T6200DA	482
1T6107EL	98, 480	1T6157DA	100, 483	1T6200EL	482
1T6114DA	99, 481	1T6157EL	100, 483	1T6201DA	482
1T6114EL	99, 481	1T6158DA	100, 483	1T6201EL	482
1T6115DA	99, 481	1T6158EL	100, 483	1T6202DA	482
1T6115EL	99, 481	1T6159DA	100, 483	1T6202EL	482
1T6116DA	99, 481	1T6159EL	100, 483	1T6203DA	482
1T6116EL	99, 481	1T6160DA	100, 483	1T6203EL	482
1T6117DA	99, 481	1T6160EL	100, 483	1T6210DA	100, 483
1T6117EL	99, 481	1T6161DA	100, 483	1T6210EL	100, 483
1T6118DA	99, 481	1T6161EL	100, 483	1T6211DA	100, 483
1T6118EL	99, 481	1T6162DA	482	1T6211EL	100, 483
1T6119DA	99, 481	1T6162EL	482	1T6212DA	100, 483
1T6119EL	99, 481	1T6163DA	482	1T6212EL	100, 483
1T6126DA	481	1T6163EL	482	1T6213DA	100, 483
1T6126EL	481	1T6164DA	482	1T6213EL	100, 483
1T6127DA	481	1T6164EL	482	1T6214DA	100, 483
1T6127EL	481	1T6165DA	482	1T6214EL	100, 483
1T6128DA	481	1T6165EL	482	1T6215DA	100, 483
1T6128EL	481	1T6166DA	482	1T6215EL	100, 483
1T6129DA	481	1T6166EL	482	1T6216DA	101, 483
1T6129EL	481	1T6167DA	482	1T6216EL	101, 483
1T6130DA	481	1T6167EL	482	1T6217DA	101, 483
1T6130EL	481	1T6168DA	482	1T6217EL	101, 483
1T6131DA	481	1T6168EL	482	1T6218DA	101, 483
1T6131EL	481	1T6169DA	482	1T6218EL	101, 483
1T6138DA	99, 481	1T6169EL	482	1T6219DA	101, 483
1T6138EL	99, 481	1T6170DA	482	1T6219EL	101, 483
1T6139DA	99, 481	1T6170EL	482	1T6220DA	101, 483
1T6139EL	99, 481	1T6171DA	482	1T6220EL	101, 483
1T6140DA	99, 481	1T6171EL	482	1T6221DA	101, 483
1T6140EL	99, 481	1T6172DA	482	1T6221EL	101, 483

COD.	PAG.
1T6222DA	101, 484
1T6222EL	101, 484
1T6223DA	101, 484
1T6223EL	101, 484
1T6224DA	101, 484
1T6224EL	101, 484
1T6225DA	101, 484
1T6225EL	101, 484
1T6226DA	101, 484
1T6226EL	101, 484
1T6227DA	101, 484
1T6227EL	101, 484
1T6228DA	101, 484
1T6228EL	101, 484
1T6229DA	101, 484
1T6229EL	101, 484
1T6230DA	101, 484
1T6230EL	101, 484
1T6231DA	101, 484
1T6231EL	101, 484
1T6232DA	101, 484
1T6232EL	101, 484
1T6233DA	101, 484
1T6233EL	101, 484
1T6234DA	484
1T6234EL	484
1T6235DA	484
1T6235EL	484
1T6236DA	484
1T6236EL	484
1T6237DA	484
1T6237EL	484
1T6238DA	484
1T6238EL	484
1T6239DA	484
1T6239EL	484
1T6240DA	484
1T6240EL	484
1T6241DA	484
1T6241EL	484
1T6242DA	484
1T6242EL	484
1T6243DA	484
1T6243EL	484
1T6244DA	484
1T6244EL	484
1T6245DA	484
1T6245EL	484
1T6246DA	101, 484
1T6246EL	101, 484
1T6247DA	101, 484
1T6247EL	101, 484
1T6248DA	101, 484
1T6248EL	101, 484
1T6249DA	101, 484
1T6249EL	101, 484
1T6250DA	101, 484
1T6250EL	101, 484
1T6251DA	101, 484
1T6251EL	101, 484
1T6252DA	102, 485
1T6252EL	102, 485
1T6253DA	102, 485

COD.	PAG.
1T6253EL	102, 485
1T6254DA	102, 485
1T6254EL	102, 485
1T6255DA	102, 485
1T6255EL	102, 485
1T6256DA	102, 485
1T6256EL	102, 485
1T6257DA	102, 485
1T6257EL	102, 485
1T6258DA	102, 485
1T6258EL	102, 485
1T6259DA	102, 485
1T6259EL	102, 485
1T6260DA	102, 485
1T6260EL	102, 485
1T6261DA	102, 485
1T6261EL	102, 485
1T6262DA	102, 485
1T6262EL	102, 485
1T6263DA	102, 485
1T6263EL	102, 485
1T6264DA	102, 485
1T6264EL	102, 485
1T6265DA	102, 485
1T6265EL	102, 485
1T6266DA	102, 485
1T6266EL	102, 485
1T6267DA	102, 485
1T6267EL	102, 485
1T6268DA	102, 485
1T6268EL	102, 485
1T6269DA	102, 485
1T6269EL	102, 485
1T6270DA	485
1T6270EL	485
1T6271DA	485
1T6271EL	485
1T6272DA	485
1T6272EL	485
1T6273DA	485
1T6273EL	485
1T6274DA	485
1T6274EL	485
1T6275DA	485
1T6275EL	485
1T6276DA	485
1T6276EL	485
1T6277DA	485
1T6277EL	485
1T6278DA	485
1T6278EL	485
1T6279DA	485
1T6279EL	485
1T6280DA	485
1T6280EL	485
1T6281DA	485
1T6281EL	485
1T6282	486
1T6285	486
1T6288DA	486
1T6288EL	486
1T6289DA	486
1T6289EL	486

COD.	PAG.
1T6290DA	486
1T6290EL	486
1T6291	103
1T6292	103
1T6293	103
1T6294	103
1T6295	103
1T6296	103
1T6297	103
1T6298	103
1T6299	103
1T6300	103
1T6301	103
1T6302	103
1T6303	103
1T6304	103
1T6305	103
1T6306	103
1T6307	103
1T6308	103
1T6309DA	295
1T6309EL	295
1T6310DA	295
1T6310EL	295
1T6311DA	295
1T6311EL	295
1T6312DA	295
1T6312EL	295
1T6313DA	294
1T6313EL	294
1T6314DA	294
1T6314EL	294
1T6315DA	294
1T6315EL	294
1T6316DA	294
1T6316EL	294
1T6317	276
1T6318	276
1T6319	276
1T6320	276
1T6321	276
1T6322	276
1T6323	276
1T6324	276
1T6325	328
1T6326	328
1T6327	328
1T6328	328
1T6329	329
1T6330	329
1T6331	327
1T6332	327
1T6333	219
1T6334	219
1T6335	219
1T6336	219
1T6337	328
1T6338	328
1T6339	328
1T6340	328
1T6341	329
1T6342	329
1T6343	327

INDEX FOR CODE

COD.	PAG.	COD.	PAG.	COD.	PAG.
1T6344	327	1T6406	103	1T6450DA	181
1T6345	219	1T6407	159	1T6450EL	181
1T6346	219	1T6408	159	1T6451DA	181
1T6347	219	1T6415	215	1T6451EL	181
1T6348	219	1T6416	215	1T6452DA	181
1T6349	328	1T6417	216	1T6452EL	181
1T6350	328	1T6418	216	1T6453DA	181
1T6351	328	1T6419DA	189	1T6453EL	181
1T6352	328	1T6419EL	189	1T6454DA	182
1T6353	329	1T6420DA	189	1T6454EL	182
1T6354	329	1T6420EL	189	1T6455DA	181
1T6355	327	1T6421DA	189	1T6455EL	181
1T6356	327	1T6421EL	189	1T6456DA	182
1T6357	219	1T6422DA	189	1T6456EL	182
1T6358	219	1T6422EL	189	1T6457DA	182
1T6359	219	1T6423	189	1T6457EL	182
1T6360	219	1T6424	189	1T6458DA	182
1T6361	158	1T6425	189	1T6458EL	182
1T6362	158	1T6426	189	1T6459DA	182
1T6363	158	1T6427	189	1T6459EL	182
1T6364	158	1T6428	189	1T6460DA	182
1T6365	158	1T6429DA	181	1T6460EL	182
1T6366	158	1T6429EL	181	1T6461DA	182
1T6367	158	1T6430DA	181	1T6461EL	182
1T6368	158	1T6430EL	181	1T6462DA	182
1T6369	158	1T6431DA	181	1T6462EL	182
1T6370	158	1T6431EL	181	1T6463DA	182
1T6371	158	1T6432DA	181	1T6463EL	182
1T6372	158	1T6432EL	181	1T6464DA	182
1T6373	126	1T6433DA	181	1T6464EL	182
1T6374	126	1T6433EL	181	1T6465DA	182
1T6375	126	1T6434DA	181	1T6465EL	182
1T6376	126	1T6434EL	181	1T6466DA	183
1T6377	209	1T6435DA	181	1T6466EL	183
1T6378	209	1T6435EL	181	1T6467DA	182
1T6379	209	1T6436DA	181	1T6467EL	182
1T6380	209	1T6436EL	181	1T6468DA	183
1T6381	154, 190, 206, 240, 252, 276, 321, 375	1T6437DA	181	1T6468EL	183
1T6382	142, 149, 261, 314	1T6437EL	181	1T6469DA	183
1T6383	154, 190, 206, 240, 252, 276, 321, 375	1T6438DA	182	1T6469EL	183
1T6384	142, 149, 261, 314	1T6438EL	182	1T6470DA	183
1T6385	154, 190, 206, 240, 252, 276, 321, 375	1T6439DA	181	1T6470EL	183
1T6386	142, 149, 261, 315	1T6439EL	181	1T6471DA	183
1T6387	154, 190, 206, 240, 252, 276, 321, 375	1T6440DA	182	1T6471EL	183
1T6388	142, 149, 261, 315	1T6440EL	182	1T6472DA	183
1T6389	154, 190, 206, 240, 252, 276, 321, 375	1T6441DA	182	1T6472EL	183
1T6390	142, 149, 261, 315	1T6441EL	182	1T6473DA	183
1T6391	154, 190, 206, 240, 252, 276, 321, 375	1T6442DA	182	1T6473EL	183
1T6392	142, 149, 261, 315	1T6442EL	182	1T6474DA	183
1T6393	154, 190, 206, 240, 253, 277, 322, 375	1T6443DA	182	1T6474EL	183
1T6394	142, 149, 261, 315	1T6443EL	182	1T6475DA	183
1T6401	103	1T6444DA	182	1T6475EL	183
1T6402	103	1T6444EL	182	1T6476DA	183
1T6403	103	1T6445DA	181	1T6476EL	183
1T6404	103	1T6445EL	181	1T6477DA	182
1T6405	103	1T6446DA	181	1T6477EL	182
		1T6446EL	181	1T6478DA	182
		1T6447DA	181	1T6478EL	182
		1T6447EL	181	1T6479DA	182
		1T6448DA	181	1T6479EL	182
		1T6448EL	181	1T6480DA	182
		1T6449DA	181	1T6480EL	182
		1T6449EL	181	1T6481DA	182

COD.	PAG.
1T6481EL	182
1T6482DA	183
1T6482EL	183
1T6483DA	182
1T6483EL	182
1T6484DA	183
1T6484EL	183
1T6485DA	183
1T6485EL	183
1T6486DA	183
1T6486EL	183
1T6487DA	183
1T6487EL	183
1T6488DA	183
1T6488EL	183
1T6489DA	183
1T6489EL	183
1T6490DA	183
1T6490EL	183
1T6491DA	183
1T6491EL	183
1T6492DA	183
1T6492EL	183
1T6493	183
1T6494	183
1T6495	184
1T6496	183
1T6497	183
1T6498	184
1T6499	788
1T6500	228
1T6501	231
1T6502	88, 92, 394, 399, 407, 455
1T6503	126, 158
1T6504	126, 158, 209
1T6505	209
1T6506	184, 203, 241, 247, 272
1T6507	184, 203, 241, 247, 272
1T6508	185, 203, 241, 247, 272
1T6509	185, 203, 241, 247, 272
1T6510	185, 203, 241, 247, 272
1T6511	185, 203, 241, 247, 272
1T6512	185, 203, 241, 247, 272
1T6521	191, 207, 239, 253, 277, 375
1T6522	185, 203, 248, 261, 265, 273
1T6523	269
1T6524	219, 327, 329
1T6525	329
1T6526	329
1T6527	329
1T6528	327
1T6529	327
1T6530	327

COD.	PAG.
1T6531DA	233
1T6531EL	233
1T6532DA	233
1T6532EL	233
1T6533DA	233
1T6533EL	233
1T6534DA	233
1T6534EL	233
1T6535DA	233
1T6535EL	233
1T6536DA	233
1T6536EL	233
1T6537DA	233
1T6537EL	233
1T6538DA	233
1T6538EL	233
1T6539DA	233
1T6539EL	233
1T6540DA	233
1T6540EL	233
1T6541DA	233
1T6541EL	233
1T6542DA	233
1T6542EL	233
1T6543DA	233
1T6543EL	233
1T6544DA	233
1T6544EL	233
1T6545DA	233
1T6545EL	233
1T6546DA	233
1T6546EL	233
1T6547DA	233
1T6547EL	233
1T6548DA	233
1T6548EL	233
1T6549DA	233
1T6549EL	233
1T6550DA	233
1T6550EL	233
1T6551DA	194
1T6551EL	194
1T6552DA	194
1T6552EL	194
1T6553DA	194
1T6553EL	194
1T6554DA	194
1T6554EL	194
1T6555DA	194
1T6555EL	194
1T6556DA	194
1T6556EL	194
1T6557DA	194
1T6557EL	194
1T6558DA	194
1T6558EL	194
1T6559DA	194
1T6559EL	194
1T6560DA	194
1T6560EL	194
1T6561DA	194
1T6561EL	194
1T6562DA	194

COD.	PAG.
1T6562EL	194
1T6563DA	194
1T6563EL	194
1T6564DA	194
1T6564EL	194
1T6565DA	194
1T6565EL	194
1T6566DA	194
1T6566EL	194
1T6567DA	194
1T6567EL	194
1T6568DA	194
1T6568EL	194
1T6569DA	194
1T6569EL	194
1T6570DA	194
1T6570EL	194
1T6571	195, 234
1T6572	195, 234
1T6573	195, 234
1T6574	195, 234
1T6575	195, 234
1T6576	195, 234
1T6579	195
1T6580	195
1T6581	609, 613, 617, 619, 695, 698, 700, 721, 723, 735, 738, 779
1T6582DA	238
1T6582EL	238
1T6583DA	238
1T6583EL	238
1T6584DA	238
1T6584EL	238
1T6585DA	238
1T6585EL	238
1T6586DA	238
1T6586EL	238
1T6587DA	238
1T6587EL	238
1T6588DA	238
1T6588EL	238
1T6589DA	238
1T6589EL	238
1T6590DA	238
1T6590EL	238
1T6591DA	238
1T6591EL	238
1T6592DA	238
1T6592EL	238
1T6593DA	238
1T6593EL	238
1T6594DA	238
1T6594EL	238
1T6595DA	238
1T6595EL	238
1T6596DA	238
1T6596EL	238
1T6597DA	238
1T6597EL	238
1T6598DA	238
1T6598EL	238
1T6599DA	238

INDEX FOR CODE

COD.	PAG.	COD.	PAG.	COD.	PAG.
1T6599EL	238	1T6631EL	369	1T6663DA	371
1T6600DA	239	1T6632DA	369	1T6663EL	371
1T6600EL	238	1T6632EL	369	1T6664DA	371
1T6601DA	239	1T6633DA	369	1T6664EL	371
1T6601EL	238	1T6633EL	369	1T6665DA	371
1T6602DA	239	1T6634DA	369	1T6665EL	371
1T6602EL	238	1T6634EL	369	1T6666DA	371
1T6603DA	239	1T6635DA	369	1T6666EL	371
1T6603EL	238	1T6635EL	369	1T6667DA	371
1T6604DA	239	1T6636DA	369	1T6667EL	371
1T6604EL	238	1T6636EL	369	1T6668DA	371
1T6605DA	239	1T6637DA	369	1T6668EL	371
1T6605EL	238	1T6637EL	369	1T6669DA	371
1T6606DA	239	1T6638DA	369	1T6669EL	371
1T6606EL	239	1T6638EL	369	1T6670DA	371
1T6607DA	239	1T6639DA	370	1T6670EL	371
1T6607EL	239	1T6639EL	370	1T6671DA	371
1T6608DA	239	1T6640DA	370	1T6671EL	371
1T6608EL	239	1T6640EL	370	1T6672DA	371
1T6609DA	239	1T6641DA	370	1T6672EL	371
1T6609EL	239	1T6641EL	370	1T6673DA	371
1T6610DA	239	1T6642DA	370	1T6673EL	371
1T6610EL	239	1T6642EL	370	1T6674DA	371
1T6611DA	239	1T6643DA	370	1T6674EL	371
1T6611EL	239	1T6643EL	370	1T6675DA	372
1T6612DA	239	1T6644DA	370	1T6675EL	372
1T6612EL	239	1T6644EL	370	1T6676DA	372
1T6613DA	239	1T6645DA	370	1T6676EL	372
1T6613EL	239	1T6645EL	370	1T6677DA	372
1T6614DA	239	1T6646DA	370	1T6677EL	372
1T6614EL	239	1T6646EL	370	1T6678DA	372
1T6615DA	239	1T6647DA	370	1T6678EL	372
1T6615EL	239	1T6647EL	370	1T6679DA	372
1T6616DA	239	1T6648DA	370	1T6679EL	372
1T6616EL	239	1T6648EL	370	1T6680DA	372
1T6617DA	239	1T6649DA	370	1T6680EL	372
1T6617EL	239	1T6649EL	370	1T6681DA	373
1T6618	240	1T6650DA	370	1T6681EL	373
1T6619DA	368	1T6650EL	370	1T6682DA	373
1T6619EL	368	1T6651DA	370	1T6682EL	373
1T6620DA	368	1T6651EL	370	1T6683DA	373
1T6620EL	368	1T6652DA	370	1T6683EL	373
1T6621DA	368	1T6652EL	370	1T6684DA	373
1T6621EL	368	1T6653DA	370	1T6684EL	373
1T6622DA	368	1T6653EL	370	1T6685DA	373
1T6622EL	368	1T6654DA	370	1T6685EL	373
1T6623DA	368	1T6654EL	370	1T6686DA	373
1T6623EL	368	1T6655DA	370	1T6686EL	373
1T6624DA	368	1T6655EL	370	1T6687DA	373
1T6624EL	368	1T6656DA	370	1T6687EL	373
1T6625DA	368	1T6656EL	370	1T6688DA	373
1T6625EL	368	1T6657DA	371	1T6688EL	373
1T6626DA	368	1T6657EL	371	1T6689DA	373
1T6626EL	368	1T6658DA	371	1T6689EL	373
1T6627DA	368	1T6658EL	371	1T6690DA	373
1T6627EL	368	1T6659DA	371	1T6690EL	373
1T6628DA	368	1T6659EL	371	1T6691DA	373
1T6628EL	368	1T6660DA	371	1T6691EL	373
1T6629DA	368	1T6660EL	371	1T6692DA	373
1T6629EL	368	1T6661DA	371	1T6692EL	373
1T6630DA	368	1T6661EL	371	1T6693DA	370
1T6630EL	368	1T6662DA	371	1T6693EL	370
1T6631DA	369	1T6662EL	371	1T6694DA	370

COD.	PAG.
1T6694EL	370
1T6695DA	370
1T6695EL	370
1T6696DA	370
1T6696EL	370
1T6697DA	370
1T6697EL	370
1T6698DA	370
1T6698EL	370
1T6699DA	371
1T6699EL	371
1T6700DA	371
1T6700EL	371
1T6701DA	371
1T6701EL	371
1T6702DA	371
1T6702EL	371
1T6703DA	371
1T6703EL	371
1T6704DA	371
1T6704EL	371
1T6705DA	371
1T6705EL	371
1T6706DA	371
1T6706EL	371
1T6707DA	371
1T6707EL	371
1T6708DA	371
1T6708EL	371
1T6709DA	371
1T6709EL	371
1T6710DA	371
1T6710EL	371
1T6711DA	372
1T6711EL	372
1T6712DA	372
1T6712EL	372
1T6713DA	372
1T6713EL	372
1T6714DA	372
1T6714EL	372
1T6715DA	372
1T6715EL	372
1T6716DA	372
1T6716EL	372
1T6717DA	372
1T6717EL	372
1T6718DA	372
1T6718EL	372
1T6719DA	372
1T6719EL	372
1T6720DA	372
1T6720EL	372
1T6721DA	372
1T6721EL	372
1T6722DA	372
1T6722EL	372
1T6723DA	372
1T6723EL	372
1T6724DA	372
1T6724EL	372
1T6725DA	372
1T6725EL	372

COD.	PAG.
1T6726DA	372
1T6726EL	372
1T6727DA	372
1T6727EL	372
1T6728DA	372
1T6728EL	372
1T6729DA	373
1T6729EL	373
1T6730DA	373
1T6730EL	373
1T6731DA	373
1T6731EL	373
1T6732DA	373
1T6732EL	373
1T6733DA	373
1T6733EL	373
1T6734DA	373
1T6734EL	373
1T6735DA	373
1T6735EL	373
1T6736DA	373
1T6736EL	373
1T6737DA	373
1T6737EL	373
1T6738DA	373
1T6738EL	373
1T6739DA	373
1T6739EL	373
1T6740DA	373
1T6740EL	373
1T6741DA	373
1T6741EL	373
1T6742DA	373
1T6742EL	373
1T6743DA	373
1T6743EL	373
1T6744DA	373
1T6744EL	373
1T6745DA	373
1T6745EL	373
1T6746DA	373
1T6746EL	373
1T6747	288
1T6748	288
1T6749	288
1T6750	288
1T6751	288
1T6752	288
1T6753	288
1T6754	288
1T6755	288
1T6756	288
1T6757	288
1T6758	288
1T6759DA	288
1T6759EL	288
1T6760DA	288
1T6760EL	288
1T6761DA	288
1T6761EL	288
1T6762DA	288
1T6762EL	288
1T6763DA	289

COD.	PAG.
1T6763EL	289
1T6764DA	289
1T6764EL	289
1T6765DA	289
1T6765EL	289
1T6766DA	289
1T6766EL	289
1T6767DA	289
1T6767EL	289
1T6768DA	289
1T6768EL	289
1T6769DA	289
1T6769EL	289
1T6770DA	289
1T6770EL	289
1T6771DA	289
1T6771EL	289
1T6772DA	289
1T6772EL	289
1T6773DA	289
1T6773EL	289
1T6774DA	289
1T6774EL	289
1T6775DA	289
1T6775EL	289
1T6776DA	289
1T6776EL	289
1T6777DA	289
1T6777EL	289
1T6778DA	289
1T6778EL	289
1T6779DA	289
1T6779EL	289
1T6780DA	289
1T6780EL	289
1T6781DA	289
1T6781EL	289
1T6782DA	289
1T6782EL	289
1T6783DA	290
1T6783EL	290
1T6784DA	290
1T6784EL	290
1T6785DA	290
1T6785EL	290
1T6786DA	290
1T6786EL	290
1T6787DA	290
1T6787EL	290
1T6788DA	290
1T6788EL	290
1T6789DA	290
1T6789EL	290
1T6790DA	290
1T6790EL	290
1T6791DA	290
1T6791EL	290
1T6792DA	290
1T6792EL	290
1T6793DA	290
1T6793EL	290
1T6794DA	290
1T6794EL	290

INDEX FOR CODE

COD.	PAG.	COD.	PAG.	COD.	PAG.
1T6795	291	1T6831EL	385	1T6863DA	391
1T6796	291	1T6832DA	385	1T6863EL	391
1T6797DA	291	1T6832EL	385	1T6864DA	391
1T6797EL	291	1T6833DA	385	1T6864EL	391
1T6798DA	291	1T6833EL	385	1T6865DA	391
1T6798EL	291	1T6834DA	385	1T6865EL	391
1T6799	290	1T6834EL	385	1T6866DA	391
1T6800	290	1T6835DA	385	1T6866EL	391
1T6801	366	1T6835EL	385	1T6867DA	392
1T6802	366	1T6836DA	385	1T6867EL	392
1T6803	366	1T6836EL	385	1T6868DA	392
1T6804	366	1T6837DA	384	1T6868EL	392
1T6805	366	1T6837EL	384	1T6869DA	392
1T6806	291	1T6838DA	384	1T6869EL	392
1T6807DA	401	1T6838EL	384	1T6870DA	392
1T6807EL	401	1T6839DA	384	1T6870EL	392
1T6808DA	401	1T6839EL	384	1T6871DA	392
1T6808EL	401	1T6840DA	384	1T6871EL	392
1T6809DA	401	1T6840EL	384	1T6872DA	392
1T6809EL	401	1T6841DA	384	1T6872EL	392
1T6810DA	401	1T6841EL	384	1T6873DA	390
1T6810EL	401	1T6842DA	384	1T6873EL	390
1T6811DA	401	1T6842EL	384	1T6874DA	390
1T6811EL	401	1T6843DA	384	1T6874EL	390
1T6812DA	401	1T6843EL	384	1T6875DA	390
1T6812EL	401	1T6844DA	384	1T6875EL	390
1T6813DA	395	1T6844EL	384	1T6876DA	390
1T6813EL	395	1T6845DA	384	1T6876EL	390
1T6814DA	395	1T6845EL	384	1T6877DA	390
1T6814EL	395	1T6846DA	384	1T6877EL	390
1T6815DA	395	1T6846EL	384	1T6878DA	390
1T6815EL	395	1T6847DA	384	1T6878EL	390
1T6816DA	395	1T6847EL	384	1T6879DA	391
1T6816EL	395	1T6848DA	384	1T6879EL	391
1T6817DA	395	1T6848EL	384	1T6880DA	391
1T6817EL	395	1T6849DA	405	1T6880EL	391
1T6818DA	395	1T6849EL	405	1T6881DA	391
1T6818EL	395	1T6850DA	405	1T6881EL	391
1T6819DA	395	1T6850EL	405	1T6882DA	391
1T6819EL	395	1T6851DA	406	1T6882EL	391
1T6820DA	395	1T6851EL	406	1T6883DA	391
1T6820EL	395	1T6852DA	406	1T6883EL	391
1T6821DA	395	1T6852EL	406	1T6884DA	391
1T6821EL	395	1T6853DA	406	1T6884EL	391
1T6822DA	395	1T6853EL	406	1T6885DA	392
1T6822EL	395	1T6854DA	406	1T6885EL	392
1T6823DA	395	1T6854EL	406	1T6886DA	392
1T6823EL	395	1T6855DA	390	1T6886EL	392
1T6824DA	395	1T6855EL	390	1T6887DA	392
1T6824EL	395	1T6856DA	390	1T6887EL	392
1T6825DA	384	1T6856EL	390	1T6888DA	392
1T6825EL	384	1T6857DA	390	1T6888EL	392
1T6826DA	384	1T6857EL	390	1T6889DA	392
1T6826EL	384	1T6858DA	390	1T6889EL	392
1T6827DA	384	1T6858EL	390	1T6890DA	392
1T6827EL	384	1T6859DA	390	1T6890EL	392
1T6828DA	384	1T6859EL	390	1T6891DA	390
1T6828EL	384	1T6860DA	390	1T6891EL	390
1T6829DA	384	1T6860EL	390	1T6892DA	390
1T6829EL	384	1T6861DA	391	1T6892EL	390
1T6830DA	384	1T6861EL	391	1T6893DA	390
1T6830EL	384	1T6862DA	391	1T6893EL	390
1T6831DA	385	1T6862EL	391	1T6894DA	390

COD.	PAG.	COD.	PAG.	COD.	PAG.
1T6894EL	390	1T6948CA	313	1T6991DA	120
1T6895DA	390	1T6950CA	202	1T6991EL	120
1T6895EL	390	1T6955CA	259	1T6992D	120
1T6896DA	390	1T6956CA	259	1T6992DA	120
1T6896EL	390	1T6957CA	259	1T6992EL	120
1T6897DA	391	1T6958CA	259	1T6993D	120
1T6897EL	391	1T6959CA	259	1T6993DA	120
1T6898DA	391	1T6960CA	259	1T6993EL	120
1T6898EL	391	1T6961CA	259	1T6994D	120
1T6899DA	391	1T6962CA	259	1T6994DA	120
1T6899EL	391	1T6963CA	259	1T6994EL	120
1T6900DA	391	1T6964CA	259	1T6995D	112
1T6900EL	391	1T6965CA	259	1T6995DA	112
1T6901DA	391	1T6966CA	259	1T6995EL	112
1T6901EL	391	1T6967CA	259	1T6996D	112
1T6902DA	391	1T6968CA	259	1T6996DA	112
1T6902EL	391	1T6969CA	259	1T6996EL	112
1T6903DA	392	1T6970CA	259	1T6997D	112
1T6903EL	392	1T6971CA	137	1T6997DA	112
1T6904DA	392	1T6972CA	137	1T6997EL	112
1T6904EL	392	1T6973CA	145	1T6998D	112
1T6905DA	392	1T6974CA	145	1T6998DA	112
1T6905EL	392	1T6975CA	140	1T6998EL	112
1T6906DA	392	1T6976CA	140	1T6999D	120
1T6906EL	392	1T6977CA	148	1T6999DA	120
1T6907DA	392	1T6978CA	148	1T6999EL	120
1T6907EL	392	1T6979D	112	1T7000D	120
1T6908DA	392	1T6979DA	112	1T7000DA	120
1T6908EL	392	1T6979EL	112	1T7000EL	120
1T6916EL	367	1T6980D	112	1T7001D	120
1T6917EL	366	1T6980DA	112	1T7001DA	120
1T6918	269	1T6980EL	112	1T7001EL	120
1T6919	393, 411, 422, 429, 454	1T6981D	112	1T7002D	120
1T6920	393, 411, 422, 429, 454	1T6981DA	112	1T7002DA	120
1T6921	393, 411, 422, 429, 454	1T6981EL	112	1T7002EL	120
1T6922	374	1T6982D	112	1T7003	720
1T6923	374	1T6982DA	112	1T7004	280
1T6924	374	1T6982EL	112	1T7005	280
1T6925	374	1T6983D	112	1T7006	280
1T6926	374	1T6983DA	112	1T7007	280
1T6927	374	1T6983EL	112	1T7008	280
1T6928	374	1T6984D	112	1T7009	280
1T6930	375	1T6984DA	112	1T7016	344
1T6931	374	1T6984EL	112	1T7017	344
1T6932	374	1T6985D	112	1T7018	344
1T6933	374	1T6985DA	112	1T7019	344
1T6934	374	1T6985EL	112	1T7020	344
1T6935	374	1T6986D	112	1T7021	344
1T6936	374	1T6986DA	112	1T7022	344
1T6937	374	1T6986EL	112	1T7023	344
1T6938	374	1T6987D	120	1T7024	343
1T6939	374	1T6987DA	120	1T7025	343
1T6940	290	1T6987EL	120	1T7026	343
1T6941CA	230	1T6988D	120	1T7027	343
1T6942CA	230	1T6988DA	120	1T7028EL	343
1T6943CA	230	1T6988EL	120	1T7029EL	343
1T6944CA	230	1T6989D	120	1T7030EL	343
1T6945CA	312	1T6989DA	120	1T7031	352
1T6946CA	312	1T6989EL	120	1T7032	352
1T6947CA	313	1T6990D	120	1T7033	352
		1T6990DA	120	1T7034	352
		1T6990EL	120	1T7035	352
		1T6991D	120	1T7036	352

INDEX FOR CODE

COD.	PAG.	COD.	PAG.	COD.	PAG.
1T7037	353	1T7100CA	345	1T7132	347
1T7038	353	1T7101	345	1T7132CA	346
1T7039	353	1T7101CA	345	1T7133	347
1T7040	353	1T7102	345	1T7133CA	346
1T7041	353	1T7102CA	345	1T7134	347
1T7043	352	1T7103	345	1T7134CA	346
1T7044	354	1T7103CA	345	1T7135	346
1T7045	354	1T7104	345	1T7135CA	346
1T7046	354	1T7104CA	345	1T7136	346
1T7047	354	1T7105	345	1T7136CA	346
1T7048	354	1T7105CA	345	1T7137	346
1T7049	354	1T7106	345	1T7137CA	346
1T7050	354	1T7106CA	345	1T7138	346
1T7051	354	1T7107	346	1T7138CA	346
1T7052	354	1T7107CA	345	1T7139	347
1T7053	354	1T7108	346	1T7139CA	346
1T7054	354	1T7108CA	345	1T7140	347
1T7055	354	1T7109	346	1T7140CA	346
1T7056	355	1T7109CA	345	1T7141	347
1T7057	356	1T7110	346	1T7141CA	346
1T7058	356	1T7110CA	345	1T7142	347
1T7059	355	1T7111	345	1T7142CA	346
1T7060	356	1T7111CA	345	1T7143	347
1T7061	356	1T7112	345	1T7143CA	346
1T7062	355	1T7112CA	345	1T7144	347
1T7063	355	1T7113	345	1T7144CA	346
1T7064	356	1T7113CA	345	1T7145	347
1T7065	355	1T7114	345	1T7145CA	346
1T7066	355	1T7114CA	345	1T7146	347
1T7067	352	1T7115	345	1T7146CA	346
1T7068	352	1T7115CA	345	1T7147	348
1T7069	352	1T7116	345	1T7147CA	347
1T7070	352	1T7116CA	345	1T7148	348
1T7071	352	1T7117	345	1T7148CA	347
1T7072	352	1T7117CA	345	1T7149	348
1T7073	353	1T7118	345	1T7149CA	347
1T7074	353	1T7118CA	345	1T7150	348
1T7076	352	1T7119	346	1T7150CA	347
1T7077	355	1T7119CA	345	1T7151	348
1T7078	355	1T7120	346	1T7151CA	347
1T7079	355	1T7120CA	345	1T7152	348
1T7080	355	1T7121	346	1T7152CA	347
1T7081	355	1T7121CA	345	1T7153	348
1T7082	355	1T7122	346	1T7153CA	347
1T7083	354	1T7122CA	345	1T7154	348
1T7084	354	1T7123	346	1T7154CA	347
1T7085	354	1T7123CA	346	1T7155	348
1T7086	354	1T7124	346	1T7155CA	347
1T7087	354	1T7124CA	346	1T7156	348
1T7088	354	1T7125	346	1T7156CA	347
1T7089	355	1T7125CA	346	1T7157	348
1T7090	356	1T7126	346	1T7157CA	347
1T7091	356	1T7126CA	346	1T7158	348
1T7092	355	1T7127	347	1T7158CA	347
1T7093	356	1T7127CA	346	1T7159	348
1T7094	356	1T7128	347	1T7159CA	347
1T7095	355	1T7128CA	346	1T7160	348
1T7096	355	1T7129	347	1T7160CA	347
1T7097	356	1T7129CA	346	1T7161	348
1T7098	344	1T7130	347	1T7161CA	347
1T7099	345	1T7130CA	346	1T7162	348
1T7099CA	345	1T7131	347	1T7162CA	347
1T7100	345	1T7131CA	346	1T7163	348

COD.	PAG.	COD.	PAG.	COD.	PAG.
1T7163CA	347	1T7196DA	440	1T7227EL	408
1T7164	348	1T7196EL	440	1T7228DA	408
1T7164CA	347	1T7197DA	413	1T7228EL	408
1T7165	348	1T7197EL	413	1T7229DA	408
1T7165CA	347	1T7198DA	413	1T7229EL	408
1T7166	348	1T7198EL	413	1T7230DA	408
1T7166CA	347	1T7199DA	413	1T7230EL	408
1T7167	348	1T7199EL	413	1T7231DA	408
1T7167CA	347	1T7200DA	413	1T7231EL	408
1T7168	348	1T7200EL	413	1T7232DA	408
1T7168CA	347	1T7201DA	413	1T7232EL	408
1T7169	348	1T7201EL	413	1T7233DA	408
1T7169CA	347	1T7202DA	413	1T7233EL	408
1T7170	348	1T7202EL	413	1T7234DA	408
1T7170CA	347	1T7203DA	413	1T7234EL	408
1T7171	366	1T7203EL	413	1T7235DA	408
1T7172EL	343	1T7204DA	413	1T7235EL	408
1T7173DA	417	1T7204EL	413	1T7236DA	408
1T7173EL	417	1T7205DA	413	1T7236EL	408
1T7174DA	417	1T7205EL	413	1T7237DA	408
1T7174EL	417	1T7206DA	413	1T7237EL	408
1T7175DA	417	1T7206EL	413	1T7238DA	408
1T7175EL	417	1T7207DA	413	1T7238EL	408
1T7176DA	417	1T7207EL	413	1T7239DA	408
1T7176EL	417	1T7208DA	413	1T7239EL	408
1T7177DA	417	1T7208EL	413	1T7240DA	409
1T7177EL	417	1T7209DA	413	1T7240EL	409
1T7178DA	417	1T7209EL	413	1T7241DA	409
1T7178EL	417	1T7210DA	414	1T7241EL	409
1T7179DA	440	1T7210EL	414	1T7242DA	408
1T7179EL	440	1T7211DA	414	1T7242EL	408
1T7180DA	440	1T7211EL	414	1T7243DA	409
1T7180EL	440	1T7212DA	413	1T7243EL	409
1T7181DA	440	1T7212EL	413	1T7244DA	409
1T7181EL	440	1T7213DA	414	1T7244EL	409
1T7182DA	440	1T7213EL	414	1T7245DA	408
1T7182EL	440	1T7214DA	414	1T7245EL	408
1T7183DA	440	1T7214EL	414	1T7246DA	409
1T7183EL	440	1T7215DA	413	1T7246EL	409
1T7184DA	440	1T7215EL	413	1T7247DA	409
1T7184EL	440	1T7216DA	414	1T7247EL	409
1T7185DA	417	1T7216EL	414	1T7248DA	408
1T7185EL	417	1T7217DA	414	1T7248EL	408
1T7186DA	418	1T7217EL	414	1T7249DA	409
1T7186EL	418	1T7218DA	413	1T7249EL	409
1T7187DA	418	1T7218EL	413	1T7250DA	409
1T7187EL	418	1T7219DA	414	1T7250EL	409
1T7188DA	417	1T7219EL	414	1T7251DA	408
1T7188EL	417	1T7220DA	414	1T7251EL	408
1T7189DA	418	1T7220EL	414	1T7252DA	409
1T7189EL	418	1T7221DA	408	1T7252EL	409
1T7190DA	418	1T7221EL	408	1T7253DA	409
1T7190EL	418	1T7222DA	408	1T7253EL	409
1T7191DA	440	1T7222EL	408	1T7254DA	408
1T7191EL	440	1T7223DA	408	1T7254EL	408
1T7192DA	440	1T7223EL	408	1T7255DA	409
1T7192EL	440	1T7224DA	408	1T7255EL	409
1T7193DA	440	1T7224EL	408	1T7256DA	409
1T7193EL	440	1T7225DA	408	1T7256EL	409
1T7194DA	440	1T7225EL	408	1T7257DA	418
1T7194EL	440	1T7226DA	408	1T7257EL	418
1T7195DA	440	1T7226EL	408	1T7258DA	418
1T7195EL	440	1T7227DA	408	1T7258EL	418

INDEX FOR CODE

COD.	PAG.	COD.	PAG.	COD.	PAG.
1T7259DA	418	1T7290EL	414	1T7322DA	409
1T7259EL	418	1T7291DA	414	1T7322EL	409
1T7260DA	418	1T7291EL	414	1T7323DA	410
1T7260EL	418	1T7292DA	414	1T7323EL	410
1T7261DA	418	1T7292EL	414	1T7324DA	410
1T7261EL	418	1T7293DA	415	1T7324EL	410
1T7262DA	418	1T7293EL	415	1T7325DA	410
1T7262EL	418	1T7294DA	415	1T7325EL	410
1T7263DA	440	1T7294EL	415	1T7326DA	410
1T7263EL	440	1T7295DA	415	1T7326EL	410
1T7264DA	440	1T7295EL	415	1T7327DA	410
1T7264EL	440	1T7296DA	415	1T7327EL	410
1T7265DA	440	1T7296EL	415	1T7328DA	410
1T7265EL	440	1T7297DA	415	1T7328EL	410
1T7266DA	440	1T7297EL	415	1T7329DA	410
1T7266EL	440	1T7298DA	415	1T7329EL	410
1T7267DA	446	1T7298EL	415	1T7330DA	410
1T7267EL	446	1T7299DA	415	1T7330EL	410
1T7268DA	446	1T7299EL	415	1T7331DA	410
1T7268EL	446	1T7300DA	415	1T7331EL	410
1T7269DA	419	1T7300EL	415	1T7332DA	410
1T7269EL	419	1T7301DA	415	1T7332EL	410
1T7270DA	419	1T7301EL	415	1T7333DA	410
1T7270EL	419	1T7302DA	415	1T7333EL	410
1T7271DA	419	1T7302EL	415	1T7334DA	410
1T7271EL	419	1T7303DA	415	1T7334EL	410
1T7272DA	419	1T7303EL	415	1T7335DA	410
1T7272EL	419	1T7304DA	415	1T7335EL	410
1T7273DA	419	1T7304EL	415	1T7336DA	410
1T7273EL	419	1T7305DA	409	1T7336EL	410
1T7274DA	419	1T7305EL	409	1T7337DA	410
1T7274EL	419	1T7306DA	409	1T7337EL	410
1T7275DA	446	1T7306EL	409	1T7338DA	410
1T7275EL	446	1T7307DA	409	1T7338EL	410
1T7276DA	446	1T7307EL	409	1T7339DA	410
1T7276EL	446	1T7308DA	409	1T7339EL	410
1T7277DA	446	1T7308EL	409	1T7340DA	410
1T7277EL	446	1T7309DA	409	1T7340EL	410
1T7278DA	446	1T7309EL	409	1T7341DA	425
1T7278EL	446	1T7310DA	409	1T7341EL	425
1T7279DA	446	1T7310EL	409	1T7342DA	425
1T7279EL	446	1T7311DA	409	1T7342EL	425
1T7280DA	446	1T7311EL	409	1T7343DA	446
1T7280EL	446	1T7312DA	409	1T7343EL	446
1T7281DA	414	1T7312EL	409	1T7344DA	446
1T7281EL	414	1T7313DA	409	1T7344EL	446
1T7282DA	414	1T7313EL	409	1T7345DA	423
1T7282EL	414	1T7314DA	409	1T7345EL	423
1T7283DA	414	1T7314EL	409	1T7346DA	423
1T7283EL	414	1T7315DA	409	1T7346EL	423
1T7284DA	414	1T7315EL	409	1T7347DA	423
1T7284EL	414	1T7316DA	409	1T7347EL	423
1T7285DA	414	1T7316EL	409	1T7348DA	423
1T7285EL	414	1T7317DA	409	1T7348EL	423
1T7286DA	414	1T7317EL	409	1T7349DA	421
1T7286EL	414	1T7318DA	409	1T7349EL	421
1T7287DA	414	1T7318EL	409	1T7350DA	421
1T7287EL	414	1T7319DA	409	1T7350EL	421
1T7288DA	414	1T7319EL	409	1T7351DA	421
1T7288EL	414	1T7320DA	409	1T7351EL	421
1T7289DA	414	1T7320EL	409	1T7352DA	421
1T7289EL	414	1T7321DA	409	1T7352EL	421
1T7290DA	414	1T7321EL	409	1T7353DA	421

COD.	PAG.	COD.	PAG.	COD.	PAG.
1T7353EL	421	1T7406	190	1T7443	350
1T7354DA	421	1T7407	349	1T7443CA	350
1T7354EL	421	1T7407CA	348	1T7444	350
1T7355DA	425	1T7408	349	1T7444CA	350
1T7355EL	425	1T7408CA	348	1T7445	350
1T7356DA	425	1T7409	349	1T7445CA	350
1T7356EL	425	1T7409CA	348	1T7446	350
1T7357DA	446	1T7410	349	1T7446CA	350
1T7357EL	446	1T7410CA	348	1T7447	350
1T7358DA	446	1T7411	349	1T7447CA	350
1T7358EL	446	1T7411CA	348	1T7448	350
1T7359DA	423	1T7412	349	1T7448CA	350
1T7359EL	423	1T7412CA	348	1T7449	350
1T7360DA	423	1T7413	349	1T7449CA	350
1T7360EL	423	1T7413CA	348	1T7450	350
1T7361DA	423	1T7414	349	1T7450CA	350
1T7361EL	423	1T7414CA	348	1T7451	350
1T7362DA	423	1T7415	349	1T7451CA	350
1T7362EL	423	1T7415CA	349	1T7452	350
1T7363DA	421	1T7416	349	1T7452CA	350
1T7363EL	421	1T7416CA	349	1T7453	350
1T7364DA	421	1T7417	349	1T7453CA	350
1T7364EL	421	1T7417CA	349	1T7454	350
1T7365DA	421	1T7418	349	1T7454CA	350
1T7365EL	421	1T7418CA	349	1T7455	350
1T7366DA	421	1T7419	349	1T7455CA	350
1T7366EL	421	1T7419CA	348	1T7456	350
1T7367DA	421	1T7420	349	1T7456CA	350
1T7367EL	421	1T7420CA	348	1T7457	350
1T7368DA	421	1T7421	349	1T7457CA	350
1T7368EL	421	1T7421CA	348	1T7458	350
1T7369	399, 416, 424, 431	1T7422	349	1T7458CA	350
1T7370	399, 416, 424, 431	1T7422CA	348	1T7459	350
1T7371	432	1T7423	349	1T7459CA	350
1T7372	432	1T7423CA	348	1T7460	350
1T7373	432	1T7424	349	1T7460CA	350
1T7374	433	1T7424CA	348	1T7461	350
1T7375	433	1T7425	349	1T7461CA	350
1T7381	430	1T7425CA	348	1T7462	350
1T7382	430	1T7426	349	1T7462CA	350
1T7383	430	1T7426CA	348	1T7463	350
1T7384	430	1T7427	349	1T7463CA	350
1T7385	427	1T7427CA	349	1T7464	350
1T7386	427	1T7428	349	1T7464CA	350
1T7387	427	1T7428CA	349	1T7465	351
1T7388	428	1T7429	349	1T7465CA	351
1T7389	428	1T7429CA	349	1T7466	351
1T7390	427	1T7430	349	1T7466CA	351
1T7391	427	1T7430CA	349	1T7467	351
1T7392	427	1T7431	343	1T7467CA	351
1T7393	428	1T7432	343	1T7468	351
1T7394	428	1T7433	343	1T7468CA	351
1T7395	427	1T7434	343	1T7469	351
1T7396	427	1T7435	343	1T7469CA	351
1T7397	427	1T7436	343	1T7470	351
1T7398	428	1T7437	353	1T7470CA	351
1T7399	428	1T7438	353	1T7471	351
1T7400	209	1T7439	344	1T7471CA	351
1T7401	209	1T7440	344	1T7472	351
1T7402	504	1T7441	350	1T7472CA	351
1T7403EL	343	1T7441CA	350	1T7473	351
1T7404	189	1T7442	350	1T7473CA	351
1T7405	190	1T7442CA	350	1T7474	351

INDEX FOR CODE

COD.	PAG.	COD.	PAG.	COD.	PAG.
1T7474CA	351	1T7515	345	1T7578	348
1T7475	351	1T7516	345	1T7579	348
1T7475CA	351	1T7517	345	1T7580	348
1T7476	351	1T7518	345	1T7581	348
1T7476CA	351	1T7519	345	1T7582	348
1T7477	351	1T7520	345	1T7583	348
1T7477CA	351	1T7521	345	1T7584	348
1T7478	351	1T7522	345	1T7585	348
1T7478CA	351	1T7523	345	1T7586	349
1T7479	351	1T7524	345	1T7587	349
1T7479CA	351	1T7525	345	1T7588	349
1T7480	351	1T7526	345	1T7589	349
1T7480CA	351	1T7527	345	1T7590	348
1T7481	351	1T7528	345	1T7591	348
1T7481CA	351	1T7529	345	1T7592	348
1T7482	351	1T7530	346	1T7593	348
1T7482CA	351	1T7531	346	1T7594	348
1T7483	351	1T7532	346	1T7595	348
1T7483CA	351	1T7533	346	1T7596	348
1T7484	351	1T7534	346	1T7597	348
1T7484CA	351	1T7535	346	1T7598	349
1T7485	351	1T7536	346	1T7599	349
1T7485CA	351	1T7537	346	1T7600	349
1T7486	351	1T7538	346	1T7601	349
1T7486CA	351	1T7539	346	1T7602	165
1T7487	351	1T7540	346	1T7603	165
1T7487CA	351	1T7541	346	1T7604	165
1T7488	351	1T7542	346	1T7605	165
1T7488CA	351	1T7543	346	1T7606	165
1T7489	357	1T7544	346	1T7607	165
1T7490	357	1T7545	346	1T7608	165
1T7491	357	1T7546	346	1T7609	165
1T7492	357	1T7547	346	1T7610	165
1T7493	357	1T7548	346	1T7611	165
1T7494	357	1T7549	346	1T7612	165
1T7495	357	1T7550	346	1T7613	165
1T7496	357	1T7551	346	1T7614	165
1T7497	357	1T7552	346	1T7615	165
1T7498	357	1T7553	346	1T7616	165
1T7499	357	1T7554	347	1T7617	165
1T7500	357	1T7555	347	1T7618	165
1T7501	357	1T7556	347	1T7619	165
1T7502DA	232	1T7557	347	1T7620	165
1T7502DACA	232	1T7558	347	1T7621	165
1T7502EL	232	1T7559	347	1T7622	165
1T7503DA	232	1T7560	347	1T7623	165
1T7503DACA	232	1T7561	347	1T7624	165
1T7503EL	232	1T7562	347	1T7625	165
1T7504DA	232	1T7563	347	1T7626	165
1T7504DACA	232	1T7564	347	1T7627	165
1T7504EL	232	1T7565	347	1T7628	165
1T7505DA	232	1T7566	347	1T7629	165
1T7505DACA	232	1T7567	347	1T7630	166
1T7505EL	232	1T7568	347	1T7631	166
1T7506	345	1T7569	347	1T7632	166
1T7507	345	1T7570	347	1T7633	166
1T7508	345	1T7571	347	1T7634	166
1T7509	345	1T7572	347	1T7635	166
1T7510	345	1T7573	347	1T7636	166
1T7511	345	1T7574	347	1T7637	166
1T7512	345	1T7575	347	1T7638	165
1T7513	345	1T7576	347	1T7639	165
1T7514	345	1T7577	347	1T7640	165

COD.	PAG.	COD.	PAG.	COD.	PAG.
1T7641	165	1T7727	171	1T7774DA	169
1T7642	166	1T7728	171	1T7774EL	169
1T7643	166	1T7729	171	1T7775DA	169
1T7644	166	1T7730	171	1T7775EL	169
1T7645	166	1T7731	171	1T7776DA	169
1T7646	166	1T7732	171	1T7776EL	169
1T7647	166	1T7733	171	1T7777DA	169
1T7648	166	1T7746DA	168	1T7777EL	169
1T7649	166	1T7746EL	168	1T7778DA	169
1T7650	166	1T7747DA	168	1T7778EL	169
1T7651	166	1T7747EL	168	1T7779DA	169
1T7652	166	1T7748DA	168	1T7779EL	169
1T7653	166	1T7748EL	168	1T7780DA	169
1T7654	166	1T7749DA	168	1T7780EL	169
1T7655	166	1T7749EL	168	1T7781DA	169
1T7656	166	1T7750DA	168	1T7781EL	169
1T7657	166	1T7750EL	168	1T7782DA	168
1T7658	166	1T7751DA	168	1T7782EL	168
1T7659	166	1T7751EL	168	1T7783DA	168
1T7660	166	1T7752DA	168	1T7783EL	168
1T7661	166	1T7752EL	168	1T7784DA	168
1T7662	166	1T7753DA	168	1T7784EL	168
1T7663	166	1T7753EL	168	1T7785DA	168
1T7664	166	1T7754DA	168	1T7785EL	168
1T7665	166	1T7754EL	168	1T7786DA	169
1T7666	166	1T7755DA	168	1T7786EL	169
1T7667	166	1T7755EL	168	1T7787DA	169
1T7668	166	1T7756DA	168	1T7787EL	169
1T7669	166	1T7756EL	168	1T7788DA	169
1T7670	166	1T7757DA	168	1T7788EL	169
1T7671	166	1T7757EL	168	1T7789DA	169
1T7672	166	1T7758DA	168	1T7789EL	169
1T7673	166	1T7758EL	168	1T7790DA	169
1T7674	170	1T7759DA	168	1T7790EL	169
1T7675	170	1T7759EL	168	1T7791DA	169
1T7676	170	1T7760DA	168	1T7791EL	169
1T7677	170	1T7760EL	168	1T7792DA	169
1T7678	170	1T7761DA	168	1T7792EL	169
1T7679	170	1T7761EL	168	1T7793DA	169
1T7680	170	1T7762DA	168	1T7793EL	169
1T7681	170	1T7762EL	168	1T7794DA	169
1T7682	170	1T7763DA	168	1T7794EL	169
1T7683	170	1T7763EL	168	1T7795DA	169
1T7684	170	1T7764DA	168	1T7795EL	169
1T7685	170	1T7764EL	168	1T7796DA	169
1T7686DA	167, 172	1T7765DA	168	1T7796EL	169
1T7698	170	1T7765EL	168	1T7797DA	169
1T7699	170	1T7766DA	168	1T7797EL	169
1T7700	170	1T7766EL	168	1T7798DA	169
1T7701	170	1T7767DA	168	1T7798EL	169
1T7702	171	1T7767EL	168	1T7799DA	169
1T7703	171	1T7768DA	168	1T7799EL	169
1T7704	171	1T7768EL	168	1T7800DA	169
1T7705	171	1T7769DA	168	1T7800EL	169
1T7706	171	1T7769EL	168	1T7801DA	169
1T7707	171	1T7770DA	168	1T7801EL	169
1T7708	171	1T7770EL	168	1T7802DA	169
1T7709	171	1T7771DA	168	1T7802EL	169
1T7722	171	1T7771EL	168	1T7803DA	169
1T7723	171	1T7772DA	168	1T7803EL	169
1T7724	171	1T7772EL	168	1T7804DA	169
1T7725	171	1T7773DA	168	1T7804EL	169
1T7726	171	1T7773EL	168	1T7805DA	169

INDEX FOR CODE

COD.	PAG.	COD.	PAG.	COD.	PAG.
1T7805EL	169	1T7849DA	174	1T7904EL	473
1T7806DA	169	1T7849EL	174	1T7905DA	473
1T7806EL	169	1T7850DA	174	1T7905EL	473
1T7807DA	169	1T7850EL	174	1T7906DA	473
1T7807EL	169	1T7851DA	174	1T7906EL	473
1T7808DA	169	1T7851EL	174	1T7907DA	473
1T7808EL	169	1T7852DA	174	1T7907EL	473
1T7809DA	169	1T7852EL	174	1T7908DA	473
1T7809EL	169	1T7853DA	174	1T7908EL	473
1T7810DA	169	1T7853EL	174	1T7909DA	473
1T7810EL	169	1T7866DA	174	1T7909EL	473
1T7811DA	169	1T7866EL	174	1T7910DA	473
1T7811EL	169	1T7867DA	174	1T7910EL	473
1T7812DA	169	1T7867EL	174	1T7911DA	473
1T7812EL	169	1T7868DA	174	1T7911EL	473
1T7813DA	169	1T7868EL	174	1T7912DA	473
1T7813EL	169	1T7869DA	174	1T7912EL	473
1T7814DA	169	1T7869EL	174	1T7913DA	473
1T7814EL	169	1T7870DA	174	1T7913EL	473
1T7815DA	169	1T7870EL	174	1T7914DA	473
1T7815EL	169	1T7871DA	174	1T7914EL	473
1T7816DA	169	1T7871EL	174	1T7915DA	473
1T7816EL	169	1T7872DA	174	1T7915EL	473
1T7817DA	169	1T7872EL	174	1T7916DA	473
1T7817EL	169	1T7873DA	174	1T7916EL	473
1T7818DA	173	1T7873EL	174	1T7917DA	473
1T7818EL	173	1T7874DA	174	1T7917EL	473
1T7819DA	173	1T7874EL	174	1T7918DA	474
1T7819EL	173	1T7875DA	174	1T7918EL	474
1T7820DA	173	1T7875EL	174	1T7919DA	474
1T7820EL	173	1T7876DA	174	1T7919EL	474
1T7821DA	173	1T7876EL	174	1T7920DA	474
1T7821EL	173	1T7877DA	174	1T7920EL	474
1T7822DA	173	1T7877EL	174	1T7921DA	474
1T7822EL	173	1T7890DA	473	1T7921EL	474
1T7823DA	173	1T7890EL	473	1T7922DA	474
1T7823EL	173	1T7891DA	473	1T7922EL	474
1T7824DA	173	1T7891EL	473	1T7923DA	474
1T7824EL	173	1T7892DA	473	1T7923EL	474
1T7825DA	173	1T7892EL	473	1T7924DA	474
1T7825EL	173	1T7893DA	473	1T7924EL	474
1T7826DA	173	1T7893EL	473	1T7925DA	474
1T7826EL	173	1T7894DA	473	1T7925EL	474
1T7827DA	173	1T7894EL	473	1T7926DA	473
1T7827EL	173	1T7895DA	473	1T7926EL	473
1T7828DA	173	1T7895EL	473	1T7927DA	473
1T7828EL	173	1T7896DA	473	1T7927EL	473
1T7829DA	173	1T7896EL	473	1T7928DA	473
1T7829EL	173	1T7897DA	473	1T7928EL	473
1T7842DA	173	1T7897EL	473	1T7929DA	473
1T7842EL	173	1T7898DA	473	1T7929EL	473
1T7843DA	173	1T7898EL	473	1T7930DA	474
1T7843EL	173	1T7899DA	473	1T7930EL	474
1T7844DA	173	1T7899EL	473	1T7931DA	474
1T7844EL	173	1T7900DA	473	1T7931EL	474
1T7845DA	173	1T7900EL	473	1T7932DA	474
1T7845EL	173	1T7901DA	473	1T7932EL	474
1T7846DA	174	1T7901EL	473	1T7933DA	474
1T7846EL	174	1T7902DA	473	1T7933EL	474
1T7847DA	174	1T7902EL	473	1T7934DA	474
1T7847EL	174	1T7903DA	473	1T7934EL	474
1T7848DA	174	1T7903EL	473	1T7935DA	474
1T7848EL	174	1T7904DA	473	1T7935EL	474

COD.	PAG.
1T7936DA	474
1T7936EL	474
1T7937DA	474
1T7937EL	474
1T7938	344
1T7939	344
1T7940	344
1T7941	344
1T7942	344
1T7943	344
1T7944	792
1T8172DA	167, 172
1T8172EL	167, 172
1V7213	466
1V7213AB	467
1V7262	467
1V7263	467
1V7264	467
1V7343	467
1V7344	467
1V7345	467
1V7523	466
1V7524	467
323404IP	533
323414IP	533
323424IP	534
323434IP	534
323494IP	533
323900	535
344540	509
349400IP	536
349410IP	536
349420IP	537
349430IP	537
349490IP	536
374404E	539
374404IP	539
374414E	540
374414IP	540
374424E	540
374424IP	540
374604IP	539
38630P	156
38640P	156
47274	130, 130
47282	129, 129
47291	130
47292	130
47293	129
47294	129
47382	130
47385	130
49881	154, 190, 206, 252, 276, 321
49882	154, 190, 206, 252, 252, 276, 276, 321
49886	154, 190, 206, 252, 276, 321
49887	154, 190, 206, 252, 276, 321
49959	154, 190, 206, 252, 276, 321
54091	130

COD.	PAG.
54091L	130
9000-1/B-R	279
9000-1/B-ST	279
9000-1/G-R	279
9000-1/G-ST	279
9000-1/W-R	279
9000-1/W-ST	279
9000-2/B-R	279
9000-2/B-ST	279
9000-2/G-R	279
9000-2/G-ST	279
9000-2/W-R	279
9000-2/W-ST	279
9000-3/B-R	279
9000-3/B-ST	279
9000-3/G-R	279
9000-3/G-ST	279
9000-3/W-R	279
9000-3/W-ST	279
9000/BPU-D-B	228, 231, 232, 249, 262, 270, 273, 505
9000/BPU-D-G	228, 231, 232, 249, 262, 270, 273, 505
9000/BPU-D-W	228, 231, 232, 249, 262, 270, 273, 505
9000/BRU-B	228, 231, 232, 249, 262, 270, 274, 505
9000/BRU-G	228, 231, 232, 249, 262, 270, 274, 505
9000/BRU-W	228, 231, 232, 249, 262, 270, 274, 505
9001/B	280
9001/G	280
9001/W	280
9002/B	280
9002/G	280
9002/W	280
9003/B	281
9003/G	281
9003/W	281
9004-R/B	279
9004-R/G	279
9004-R/W	279
9004/B	279
9004/G	279
9004/W	279
9009/B	282
9009/G	282
9009/W	282
9010/B	281
9010/G	281
9010/W	281
9011/B	281
9011/G	281
9011/W	281
9012/B	281
9012/G	281
9012/W	281
9013/B	281
9013/G	281
9013/W	281
9014/B	281
9014/G	281

COD.	PAG.
9014/W	281
9015/B	281
9015/G	281
9015/W	281
9016/B	281
9016/G	281
9016/W	281
9017/B	282
9017/G	282
9017/W	282
9018/B	281
9018/G	281
9018/W	281
9500-1/B-ST1	365
9500-1/B-ST3	365
9500-1/B-TA1	365
9500-1/W2-ST1	365
9500-1/W2-ST3	365
9500-1/W2-TA1	365
9500-2/B-ST1	365
9500-2/B-ST3	365
9500-2/B-TA1	365
9500-2/W2-ST1	365
9500-2/W2-ST3	365
9500-2/W2-TA1	365
9500-3/B-ST1	365
9500-3/B-ST3	365
9500-3/B-TA1	365
9500-3/W2-ST1	365
9500-3/W2-ST3	365
9500-3/W2-TA1	365
9501-S/B	367
9501-S/W	367
9503-S/B	367
9503-S/W	367
9504/ST1-B	366
9504/ST1-B-F	366
9504/ST1-W2	366
9504/ST1-W2-F	366
9504/ST3-B	366
9504/ST3-W2	366
9511/B	367
9511/W2	367
S-9000/111	280
S-9000/123	280
S-9000/GP-B	282
S-9000/GP-G	282
S-9000/GP-W	282
S-9000/M-B-KIT	282
S-9000/M-G-KIT	282
S-9000/M-W-KIT	282
S-9000/T	281, 367
S-9000KIT	280
S-9001-R/6-B	282
S-9001-R/6-G	282
S-9001-R/6-W	282
S-9001/115-B	280
S-9001/115-W	280
S-9010-R/6-B	282
S-9010-R/6-G	282
S-9010-R/6-W	282
S-9011-R/6-B	282
S-9011-R/6-G	282

INDEX FOR CODE

S-9011-R/6-W	282
S-9013-R/6-B	282
S-9013-R/6-G	282
S-9013-R/6-W	282
S-9017-R/6-B	282
S-9017-R/6-G	282
S-9017-R/6-W	282
S-9500/314-B	367
S-9500/314-W2	367
S-9500/315	366
T1585	577
T1586	577

REQUISITES AND INFORMATION

All fixtures of the Targetti collection have been designed and produced to comply with European Standard EN60598-1 relative to the safety requisite of light fixtures.



DIRECTIVES EUROPEAN COUNCIL

All fixtures comply with the following directives:

- EMC Directive 2014/30/EU
- LV Directive 2014/35/EU
- RoHS Directive 2011/65/EU

UNLESS SPECIFIED OTHERWISE

- all fixtures are supplied without lamps;
- all fixtures are sold separately;
- all measurements are expressed in millimeters;
- all fixtures at low voltage are supplied without transformer;
- **all fixtures can be supplied, on request, with nominal voltage of 110V and/or 240V.**

The colors of the products illustrated are reproduced as faithfully as possible compatibly with the technical limitations of the printed medium. The company reserves the right to make changes

to the production without notice. Reproduction of this catalogue or any part of it is prohibited. The products illustrated in this catalogue are covered by one or more Italian or international patents. The company will take legal action against any imitators.

CONSORZIO ECOLIGHT

Targetti Sankey Spa is a member of the Ecolight consortium that was set up in 2004 (D.Lgs. 49/2014) to comply with the provisions of the European Directive that was adopted in Italy as the European Directive 2012/19/EU for WEEE on managing, recovering and treating waste electrical and electronic equipment, used batteries and accumulators in compliance with all applicable legislation.



TARGETTI SANKEY SpA

Certificated ISO 9001 n° 9130. TAR1

The EneC mark, awarding of the ISO9001 certificate and the CE brand all guarantee that the activities carried out internally in the company are governed and controlled by procedures which assure constant level of quality.

Accredited laboratory in accordance with ISO 17025.

LIGHT BEAM APERTURES

from	to	beam	
5°	10°	Narrow Spot	NSP
11°	25°	Spot	SP
26°	40°	Flood	FL
41°	50°	Medium Wide Flood	MWFL
51°	70°	Wide Flood	WFL
71°	120°	Very Wide Flood	VWFL
		Wall Washer	WW

SYMBOLS

INSULATION CLASS

Class I luminaire in which the protection against electrical shock is guaranteed by the connections of the conductive elements accessible to a protective conductor (earth connection). 

Luminaire in which the connection to a protective conductor (earth connection) guarantees the immunity to radio noises. 

Class II luminaire (double insulation), protected against the accidental contact with parts under tension from the user. 

Class III luminaire, suitable for connection to very low voltage circuits. 

PARTICULAR SYMBOLS

Weight of the single fixture. 

Cable length. 

DEGREE OF PROTECTION

Protective screen, keeps out solids exceeding 50 mm in size. 

Protective screen, keeps out rain and solids exceeding 12 mm in size. 

Protective screen, keeps out solids exceeding 1 mm in size. 

Protective screen, keeps out rain and solids exceeding 1 mm in size. 

Protective screen, keeps out water spray and solids exceeding 1mm in size. 

Protective screen, keeps out dust and water spray. 

Protected against powerful water jets. 

Protected against the effects of temporary immersion in water. 

Protected against the effects of continuum immersion. 

NOTE

Housing degree of protection. 

Optic degree of protection. 

SAFETY STANDARDS

ENEC
European Norms Electrical Certification. 

SUITABLE FOR INFLAMMABLE

SURFACE MOUNTING

Luminaire not suitable for direct mounting on normally inflammable surface. 

ICONS

Walk-over 

Driver-over safe 

TARGETTI IN THE WORLD

TARGETTI SANKEY S.p.A.

Via Pratese, 164
50145 Firenze - Italia

Phone 055 3791.1
Fax 055 3791.266
targetti@targetti.com
www.targetti.com

Customer Care
customer@targetti.com

Customer Service
technical@targetti.com

Lighting Consulting
project@targetti.com

China

TARGETTI LIGHTING (BEIJING) CO. LTD
Room 921 Unit 3 Guanghualu SOHO
1, n.22 Guanghai Road, Chaoyang
District, Beijing China 100020.
+86 10 65388956
teresa.yan@targetti.cn

France

TARGETTI FRANCE S.A.S.
2 Rue de la Renaissance, Bâtiment A -
92160 Antony
Paris 75008
+33 (1) 44 29 09 09
targetti.fr@targetti.com

India

TARGETTI INDIA
2nd floor, Teamwork building 18 Chin-
naswamy Mudaliar road Tasker town,
off Queens road - 560051 Bangalore
+91 80 41120016
s.karthik@targetti.com

Italy

TARGETTI SANKEY S.P.A.
Via Pratese, 164
Firenze 50145
+39 055 37911
targetti@targetti.com

Spain

TARGETTI SPAIN S.A.U
Avda. de Roma, n°69,
Barcelona 08029
+34 93 474 61 71
targetti.es@targetti.com

U.A.E.

TARGETTI SANKEY S.P.A. (BRANCH)
Dubai Airport Free Zone Authority -
Bldg.
6 West A - Office 731
Dubai P.O. Box 54744
+9714 6091033
jcoll@targetti.com

UK

TARGETTI UK LIMITED
Coppergate House
Unit 504 10 White's Row
London E1 7NF
+44 (0) 203 051 4650
m.allen@targetti.com

U.S.A.

TARGETTI USA INC.
750-A West 17th Street
Costa Mesa, CA 92626
+1 714 513 1991
targetti.usa@targetti.com

Latin America

TARGETTI LATIN AMERICA
Cra 2 Oeste # 5-262,
Edificio Av. Belalcazar, Apt. 901
Cali, Colombia
+57 3128 317174
l.valdrighi@targetti.com

Other countries www.targetti.com