

Professional Lighting 2020



DURA
LAMP
by **TARGETTI**



INDEX

DURALAMP 8

HIGHLIGHTS 16

Indoor

DOWNLIGHTS 26

TRACKLIGHT 62

LED PANELS 80

SURFACE MOUNTED FIXTURES 110

Industrial

BATTEN 116

HIGH BAY 124

Outdoor

FLOODLIGHT PROJECTORS 134

FACADE PROJECTORS 144

PROJECTORS 152

DECORATIVE FIXTURES 158

DRIVERS 169

Info Tech 171

Photometrics 177

Index 188

General Sales Conditions 192

Indoor

DOWNLIGHTS

NEW



28 BASIC

LESELI CCT



30 BASIC

LESELI



32 BASIC

LESELI
HIGH POWER



34 BASIC

LESELI
REFLECTOR

NEW



38 BASIC

LESELI DS
SLIM



40 BASIC

LESELI
SLIM



44 PLUS

RTF

NEW



46 PRO

HELIOS IP65 CCT



48 PRO

HELIOS IP65

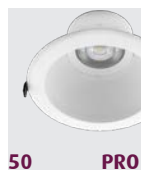

50 PRO

HELIOS UGR

NEW



52 PRO

LESELI Q PRO

MINI DOWNLIGHTS

NEW



54 PRO

LESELI MINI PRO



55 BASIC

LESELI MINI

DOWNLIGHTS WITHOUT LAMP



58 BASIC

MULTI-OPTIC
RECESSED FIXTURE



59 BASIC

ZKRR RECESSABLE
RING: ADJUSTABLE
WITH OPTIONAL
OPTICS



60 BASIC

ZK RECESSABLE
RINGS: FIXED IP65
AND ORIENTABLE
IP20



61 BASIC

ZK RECESSABLE RING:
IP20 FIXED

Indoor

TRACKLIGHT

62



64 PLUS

DURA BEAM
TRACK LIGHT



68 PRO

PROJECTOR
DURA TL



72 BASIC

TRACK PROJECTOR
FOR REPLACEABLE
LAMP



74

EUROSTANDARD
PLUS

LED PANELS

80

LED PANELS - SIDELIGHT

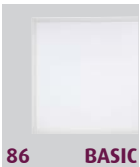

86 BASIC

SLIMFLUX NWB3
+ UGR



NEW
87 BASIC

SLIMFLUX NWB4
+ UGR

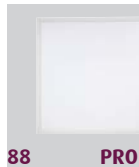

88 PRO

SLIMFLUX
IP65

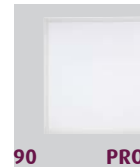

90 PRO

SLIMFLUX MULTI
CURRENT PANEL
ON/OFF

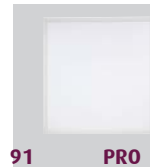

91 PRO

SLIMFLUX DALI
MULTI CURRENT
PANEL

LED PANELS - BACKLIGHT



NEW
92 PLUS

CEILING-MOUNTED
SLIMFLUX BACKLIT
PANEL

SLIMFLUX 60X60 BASIC + UGR PANELS



NEW
93 PLUS

SLIMFLUX BACKLIT
PANEL



NEW
94 PRO

SLIMFLUX BACKLIT
PANEL
UGR CCT

EVO SLIMFLUX 60X60 BASIC + UGR PANELS

SPECIAL AND DECORATIVE LED PANELS



96 PLUS

SLIMFLUX Q4



NEW
98 PLUS-PRO

VINTAGE RECESSED
PANEL + DALI



102

SLIMFLUX
ACCESSORIES



106 PRO

SLIMFLUX PANEL
ROUND 60
DIMMABLE



108 PRO

SLIMFLUX PANEL
UP&DOWN
TRANSLUCENT
DIMMABLE PANEL

Indoor

SURFACE MOUNTED FIXTURES

110

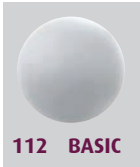

PLAF0 T2



FILINO T5

Industrial

BATTEN

116



BATTEN BT3
IP65



WATERTIGHT S1
LED
IP65



WATERTIGHT S2
IP65

HIGH BAY

124



HB3
IP65



HBL BEATRIX
IP65



PANTH SL2
IP65



HB2 PRO
IP65



HBL BEATRIX
IP65

Outdoor

FLOODLIGHT PROJECTORS

134



PANTH ST
IP65



PANTH - ST HP
IP65



PANTH EVO
IP65



PANTH EVO
PIR SENSOR
IP54



PANTH
SL2

FACADE PROJECTORS

144



MINILINI
IP65

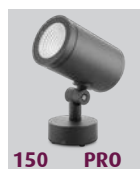

JAZZ
IP65

PROJECTORS

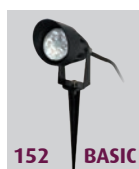

SPIKE LED
IP65



UNDERWATER
PROJECTORS
SUBAQ
IP68



INGROUND WALK-ON
FITTING IP67

DECORATIVE FIXTURES

158



BULKHEAD
T&O IP65



BULKHEAD
T&O2 - IP54



SEGNASENTIERO
IP65



ZOE
IP54

3F Filippi

TARGETTI

DURA
LAMP

Since 1952, 3F Filippi S.p.A has been a benchmark in the field of efficient technical lighting fixture design and manufacturing.

The products, which are designed and created exclusively in the Pian di Macina - Pianoro (Bologna) facilities, are an expression of the company's ability to combine the traditional and the modern, craftsmanship and technology, appearance and functionality, and efficiency and sustainability.



Targetti has been designing and producing indoor and outdoor architectural lighting fixtures since 1928.

For over ninety years, its products have been illuminating prized artistic and architectural works throughout the world and are the expression of innovation, research, and attention to detail. The company has always placed its experience and expertise at the disposal of architects, designers, and professionals in the lighting world.



With decades of experience and solid technical skill, Duralamp offers a wide range of high quality and efficient products.

Thanks to its expertise, it selects the latest generation components, engineering reliable products, with an offer that includes sources, LED strips, and lighting fixtures.



An Italian company open to the world

Founded in Florence at the beginning of the 1980s as the Luminous Springs division of Targetti Sankey s.p.a., in 1982 Duralamp became independent and began to develop in the manner most congenial to it, with an emphasis on product engineering and the improvement of technologies and production processes.

The implementation of these processes and methodologies took shape at the beginning of the 2000s, on the one hand with the acquisition, in Joint-Venture, of a production site in China, and on the other hand with the development of reliable and long-lasting partnerships with other leading production realities both in Europe and in the East.

Duralamp is part of the 3F Filippi Group | TARGETTI. The recent acquisition by 3F Filippi has made it possible to develop synergies of great interest, and allowed the Group to structure an extremely varied product portfolio. The breadth of range, production capacity and customer response has now multiplied and is able to meet both the needs of Electrical Equipment Distribution and those of Specifiers and Buyers, Architects and Lighting Designers, at a global level.





Mission and Vision

We believe that by providing the best products at the best prices it is possible to build a relationship of trust with customers that lasts over time.

Why do we believe we can do it? Because restructuring Standardised commodity products and finding the right balance of quality or even 'forging' light to meet the particular needs of an installation to us is a source of great professional satisfaction that turns into customer service.

In a wider **Vision** we work to make a positive impact on people's lives with lighting environments that have never been seen before in terms of quality and usability. While paying attention to containing both design and production costs, we are committed to using cutting-edge technology to create a new dimension of light quality and control to place users at the centre of their choices.



Technological evolution

The entire world of mass produced “light fixtures” has changed: today the request is for “lighting solutions” that are differentiated according to uses and areas of application. Duralamp is able to provide both a range of retrofitting fixtures and commodity lighting fixtures (Panels, Led, Hi Bay, Batten, Projectors etc.) as well as LED strips and power supply systems and intelligent control systems (Smart Building).

Our product improvements are dedicated to making a difference to the lifespan, emission stability over time and full compliance with requested parameters: they may not be visible but it is their effectiveness that interests us. In a world in continuous evolution we manage to maintain control over production and the choice of components to produce products with a quality/price ratio that can meet the different needs of the market.

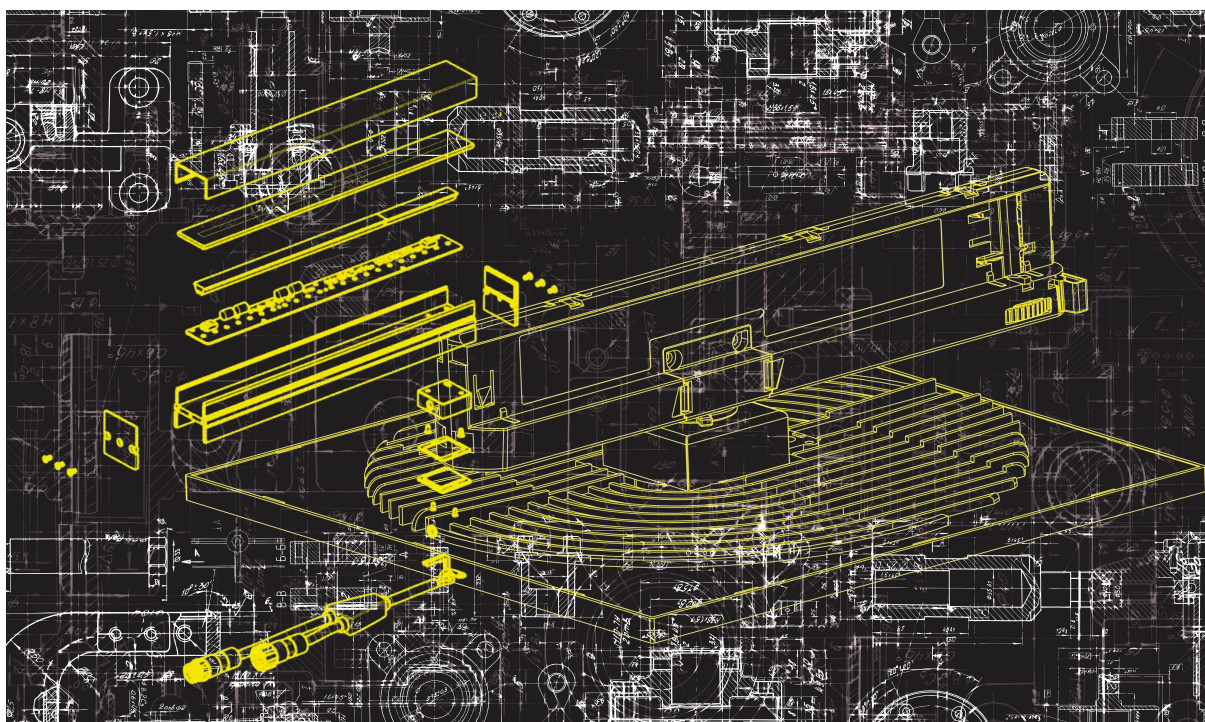



Custom-made products

The majority of products distributed worldwide are those that appear in catalogues that are differentiated according to reference markets. Yet it is custom-made products that give us the most satisfaction and allow us to put into practice all our expertise and technical ability... To satisfy particular requests from specifiers, lighting designers and architects we are able to provide 'custom-made' products, engineered, designed and built with the care a tailor puts into a made to measure shirt...

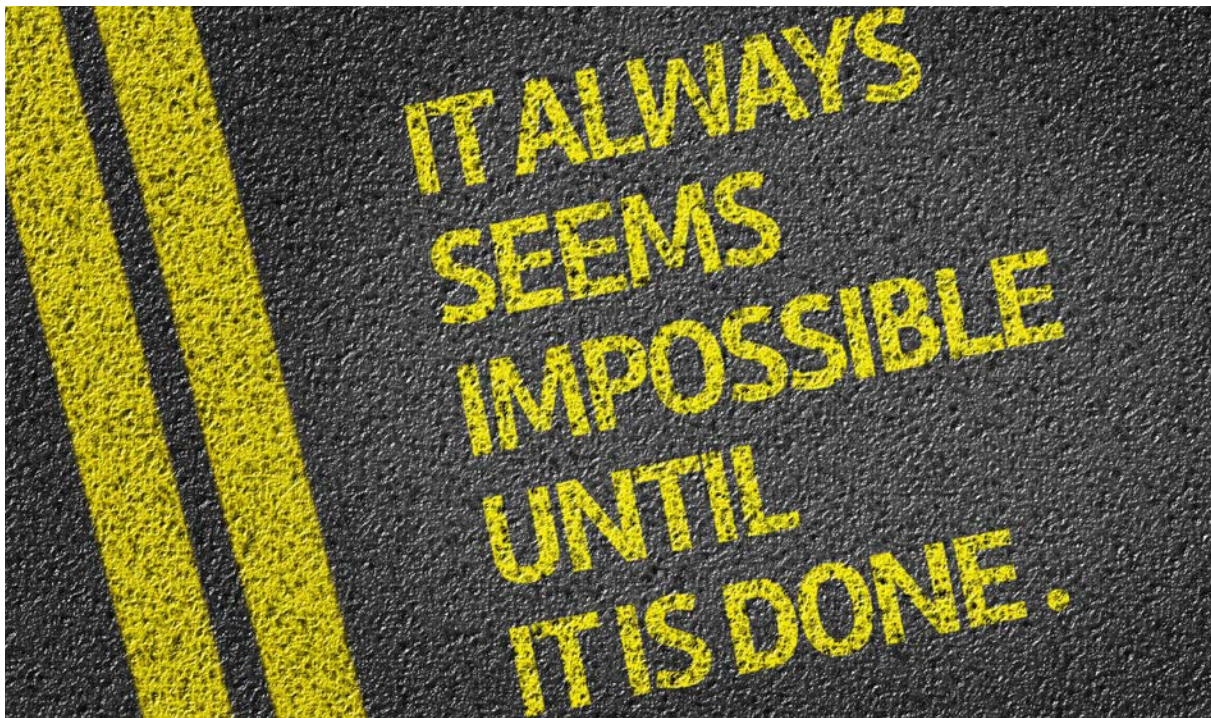

Where can you find us?

In many areas Duralamp is present with direct sales representatives able to propose solutions and provide technical support for the choices made by Specifiers. The company can also rely on a network of Distributors who manage their respective local markets with stock and pre-sales and after-sales services. This extensive and varied commercial network is a real asset that complements the international structure of the various branches in the Group. The network Duralamp operates through is really extensive and allows them to participate actively and effectively in projects in different countries around the world, in Europe, the USA, South America and the Far East.



More details on www.duralamp.it



Why choose Duralamp

Duralamp has a great advantage: a streamlined and flexible structure ready to study technology to improve existing solutions or discover new ones. Four decades of first-hand experience in production sites in China, an onsite engineering team, constant research into the most suitable materials, the most effective industrial processes, monitoring and controlling all production processes and cutting edge technology in our production sites both in Italy and abroad... all allow us to provide the expertise that has allowed us to successfully conclude high-level projects around the world. Of course in addition to daily operations that are subject to ISO 9001 Certification Quality Standards.



All Duralamp products conform to all European Directives and where required have obtained Quality and Safety marks from other countries:





Highlights



LESELI CCT

25000H L70 B20 G3 IP65 Ra>80
A range of downlights with a colour temperature selection switch as standard. A single order code will satisfy 3K, 4K or 6K requirements!



LESELI SLIM DS

15000H G2
Extremely thin recessed fixture with a body made entirely of metal to favour heat dissipation. Available in round and square versions with 3 different power supplies and colour temperatures.



HELIOS IP65

50000H G5 IP65 Ra>90
Robust and reliable aluminium body with high efficiency heat sink technology. Available with a colour temperature selection switch allowing 3K, 4K or 6K to be selected on installation.



LESELI Q PRO

50000H L70 Ra>85
A super-low profile luminaire for surface or recessed installations. Options include a version for mounting onto Eurostandard 3 Circuit Track.



LESELI Q PRO

50000H L70 Ra>85
A super-thin recessed fixture that can also be ceiling mounted and a mini-panel for track installation!



LESELI Q PRO

50000H L70 Ra>85
A super-thin recessed fixture that can also be ceiling mounted and a mini-panel for track installation!

Highlights

NEW

p. 54



LESELI MINI PRO

50000H G5h24

Miniature recessed downlight with an integrated power supply, multi-faceted reflector and a die-cast aluminium body.

NEW

p. 80



SLIMFLUX PANEL

A comprehensive range back or edge-Lit LED panels to provide uniformed and highly efficient lighting solutions for many varied ceiling & application types. Options include UGR<19 glare control, on-site colour temperature selection for 3K, 4K & 6K along with Multi Current Drivers allowing the lighting designer or installer to easily select the desired lumen requirements.

NEW

p. 118

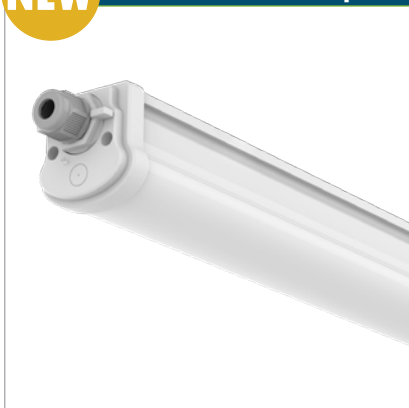

BATTEN

50000h G5h24

IP65, IK08 linear LED luminaire for surface or suspended installation. Highly efficient and robust for many varied types of industrial, commercial or residential applications.

PREVIEW

p. 120



PREVIEW ONLY

Available Autumn 2020

PREVIEW

p. 122



PREVIEW ONLY

Available Autumn 2020

Highlights

NEW

p. 126

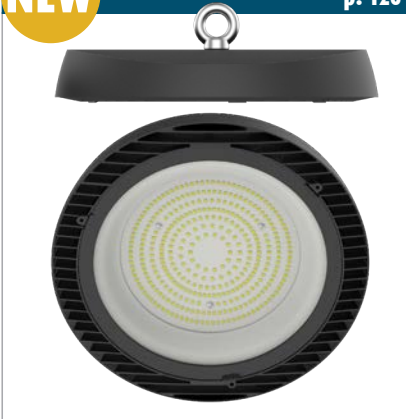

HIGH BAY - HB3

30000H G3

A new generation of professional IP65 ultra-low profile High Bay luminaires available in 100W, 150W and 200W versions. A robust IK06 fixture which is suitable for many varied industrial or commercial applications.

NEW

p. 128



HIGH BAY - BEATRIX

30000H L70 G3 50000H L70 G5

Non corrosive, IP65 Lightweight graceful body allowing for high level installation where attention to aesthetics is key. Available in two different versions with different technology and finishes.

NEW

p. 132



HIGH BAY HB2

50000h G5h24

Professional HB2 High Bay fixture now available in 100W and 150W versions with DALI options. Accessories includes the new PC transparent reflectors.

NEW

p. 138



PANTH ST HP

25000h G2

An extension of the range of high power LED projectors. Available in 100W, 150W and 200W outputs whilst utilising SMD array technology.

NEW

p. 146



MINILINI

50000h G5h24

Mains voltage linear projector for surface installation, IP65; made of extruded aluminium with an opal polycarbonate cover. Linear outdoor lighting, facades, architectural details...

NEW

p. 166



ZOE STEP MARKER

15000H G2 IP54

Compact mini recessed wall mounted luminaire with aluminium construction. Available in 3 colour options for interior and exterior use.

KEY

EXCELLENT COLOUR RENDERING

Good colour rendering improves the perception of an environment and makes it pleasant. Yet it is what is 'behind' a simple "Ra" value that really creates a good reading of the colours in an environment: modulation of the light spectrum and centring of the colour point on the McAdam ellipse are all elements that Duralamp work intensely on to keep production quality levels high.

LED LIFESPAN

LED lamps, unlike traditional lamps do not suddenly stop working but gradually decrease their initial flow unless there are defects or electric shocks. A LED lamp is considered to be no longer functioning it reaches 70% of their initial flow (L70). For example 50'000h L80B10, meaning the period of time (50'000h) in which 10% (B10) of the LED products of the same type has gradually fallen below 80% of the initial nominal flux.

The working temperature of a LED source has a significant effect on its useful life, maintenance of luminous flux and efficiency. Correct temperature management, i.e. thermal management of the power in use is a crucial factor in ensuring the performance and reliability of products.

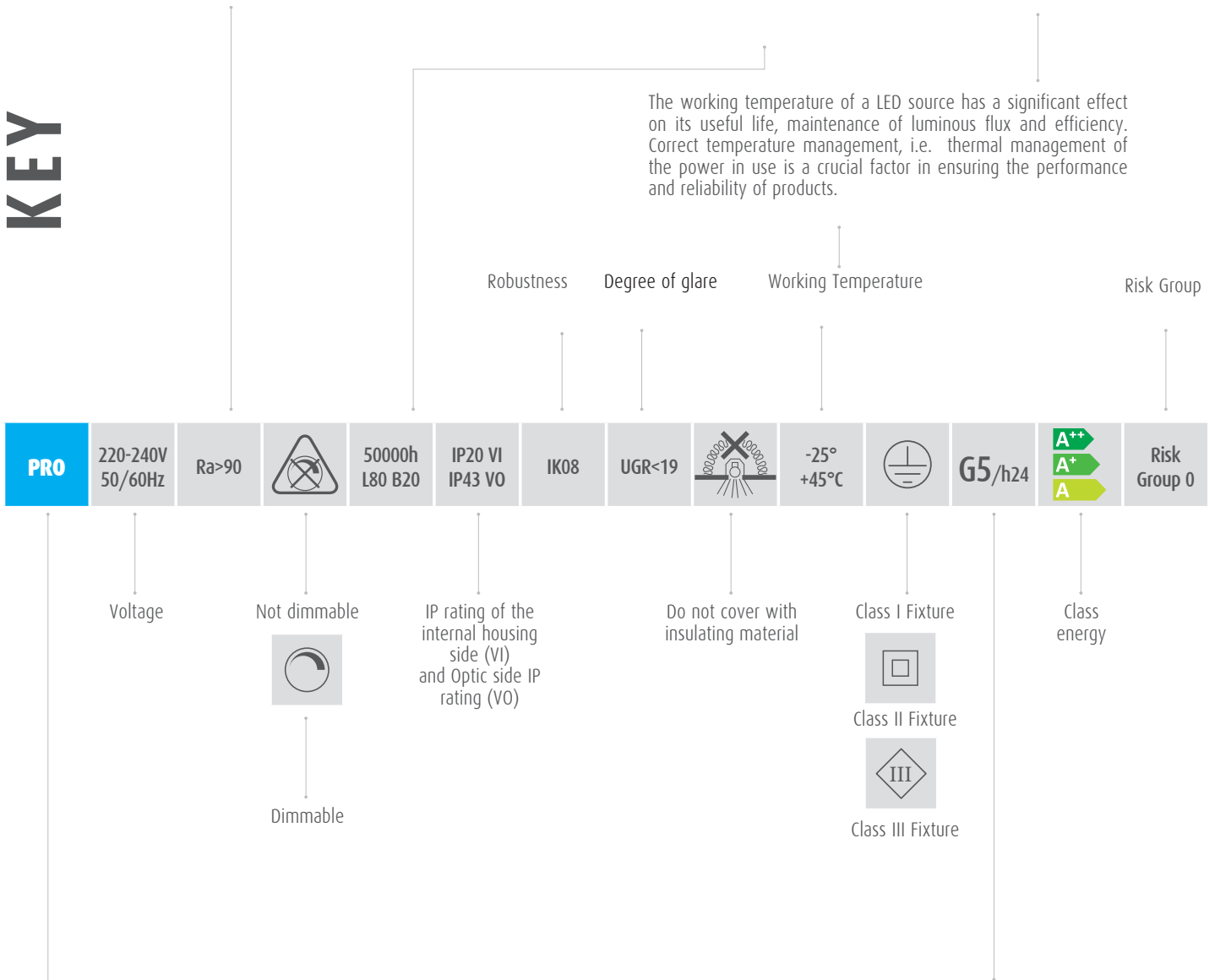

- BASIC** Ideal products for markets of consumers
- PLUS** outstanding performance and the best quality-price ratio
- PRO** specific applications and top-level features
- PROJECT** production on project specification

LED WARRANTY SPECIFICATIONS KEY











G2	Up to 2 years (4000h/year)*	*4000h = 11h a day x 365 days. Without limitations on the duration of use for the first year, provided the observance of the installation conditions.
G3	Up to 3 years (4000h/year)*	*4000h = 11h a day x 365 days. Without limitations on the duration of use for the first year, provided the observance of the installation conditions.
G4/h24	Full Guarantee 4 years (24h/24h)	h24, provides Total Warranty! The winning element for great projects.
G5/h24	Full Guarantee 5 years (24h/24h)	h24, Total Warranty up to 5 years use!

REALISTIC LUMEN

Data on luminous flux shown on the tables of Duralamp is REALISTIC and measured on the fixture after one hour of continuous use in actual conditions of use. Duralamp does not show nominal values of sources that, being higher than those emitted by fixtures are misleading for lighting considerations and for performance evaluation.

EXCELLENT COLOUR RENDERING

Good colour rendering improves the perception of the environment and makes it more pleasant. Yet it is what is really 'behind' a simple "Ra" data that really creates good colour rendering in an environment: modulation of the light spectrum and centring of the colour point on the McAdam ellipse are all elements that Duralamp work intensely on to keep production quality levels high.

art.	W	lm	K	PF	L	L1	L2		 Barcode	 Minimum Order Quantity
LP6060UGR-XXXA	40	3000	3000	0,95	595	595	9	2200	 8011905	5
 Code	 Rated watts					 Dimensions in mm		 Weight in grams		 Packing unit multiple

PF 0,9

A Power factor (PF) over 0.9 ensures fixtures that minimise the normal repercussions of losses on the network. With PF 0,9 it is not necessary to correct the electrical system which brings significant benefits in terms of cost and ease of installation in industrial plants.

FLICKER FREE

Providing greater visual comfort, improved definition of detail and reduction of stress.

COLOUR RENDERING

TM30

The Colour Rendering Index **Ra** or **CRI**, is a dimensionless index that ranges from 0 to 100 and partially describes the capacity of a light source to faithfully render the colour of a consistently lit object in line with what a reference source would do. It is based on the adherence of a source to the light emitted by a tungsten filament evaluated on a panel of 14 colour samples, of which only the first 8 are taken into consideration, none with saturated hues.

The **TM-30** 30 index allows for a more complete reading on the way a source is able to render colour. It introduces the concept of saturation, uses a balanced mixture of incandescent lamps and sunlight as a reference and extends colour samples to 99 subdivided into 7 reference areas with colours from nature for example flowers and leaves, skin tones, colours of paintings, textiles, plastics, printed material and 14 CRI colour samples.

CRI COLOUR RANGE

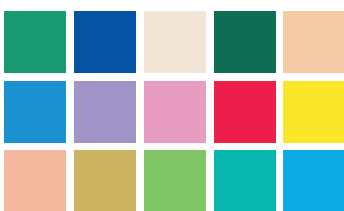

TM-30 COLOUR RANGE



The additional information that TM30 can give is provided by two graphs that summarise the values relating to Rf, Rg and Hue Shift (a shift in the colour hue, or the perception of a false colour compared to what we would see in sunlight), and the second how the source works for groups of materials (99CES) for immediate understanding:

The “rendering” of the source is expressed with a series of explanatory graphics of the colorimetric and qualitative characteristics and 2 distinct indexes.

The fidelity index Rf, which describes the ability of the source to render colours.

It varies on a scale of 0 to 100 where 100 is perfect adherence. It is also possible to have Rf targeted on one of the seven reference areas. For example “Rf skin” refers to the ability of the source to express the colours relating to the reference area concerning skin tone. It is similar to Ra but can be lower given that the reference colours range from 14 to 99.

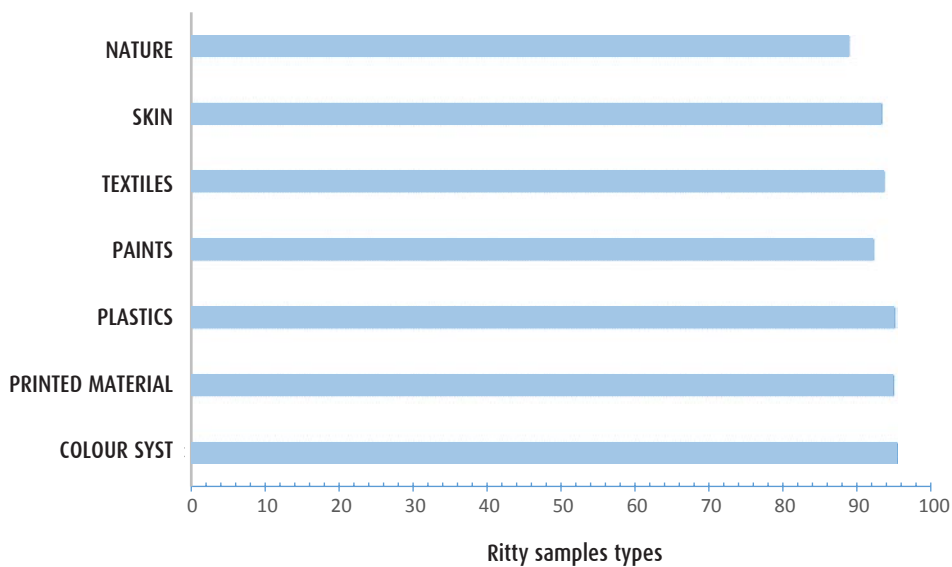

DURALAMP is able to provide TM-30 values for all ranges in the catalogue on request.

COLOUR RENDERING

TM30

The **Gamut index R_g** , which expresses the saturation level of the colours lit by the source. It varies on a scale from 60 to 140. Values lower than 100 indicate a decrease in saturation, higher values indicate an increase in saturation therefore more vivid colours.

Colours will be more or less saturated depending on whether they are inside or outside the reference circle.

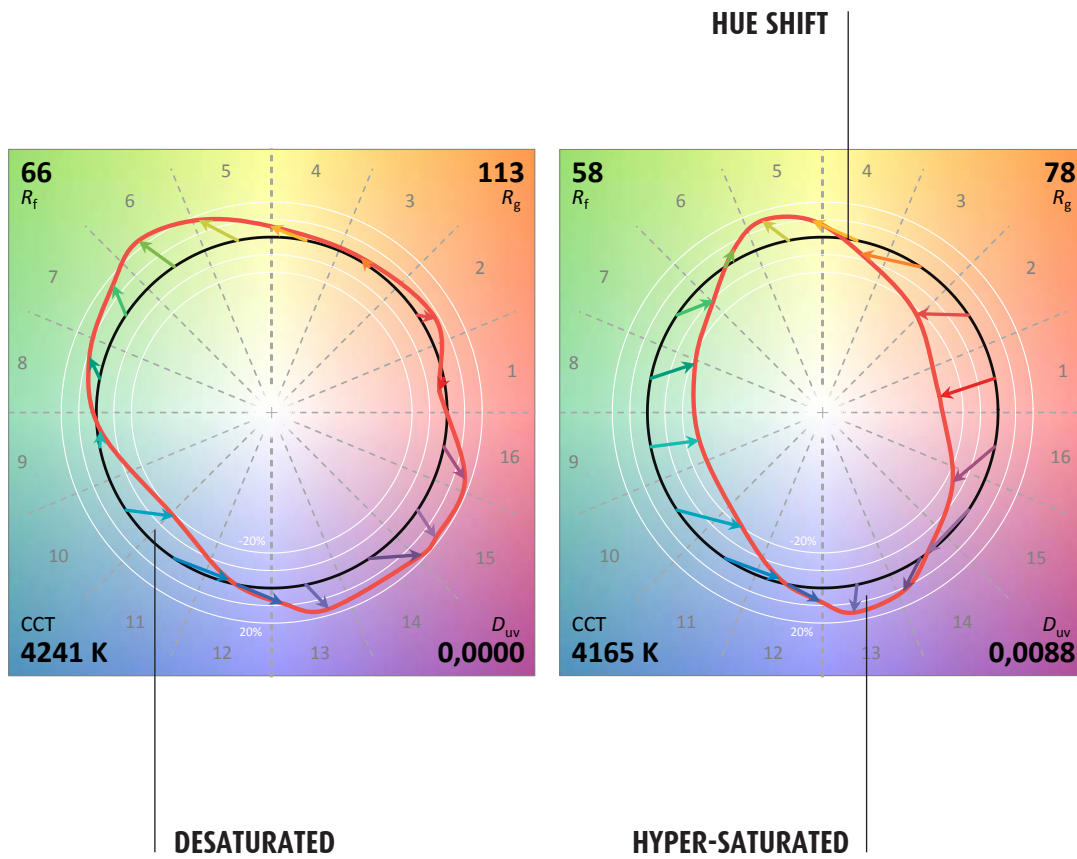

The last in-depth graph is the detail of the deviation and rendering of semitones compared to the reference source that is represented by the following diagram:

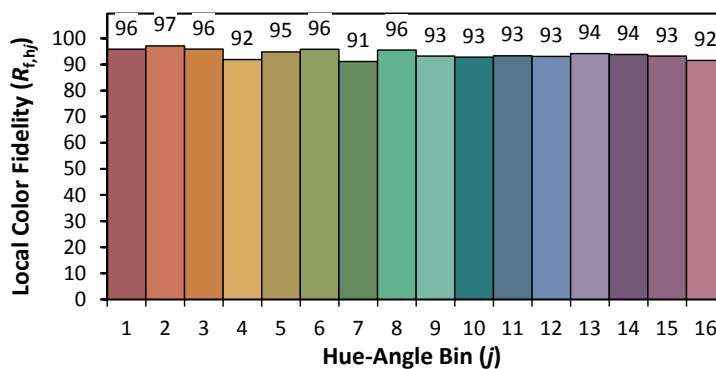



DESATURATED



HYPER-SATURATED



HUE-SHIFT

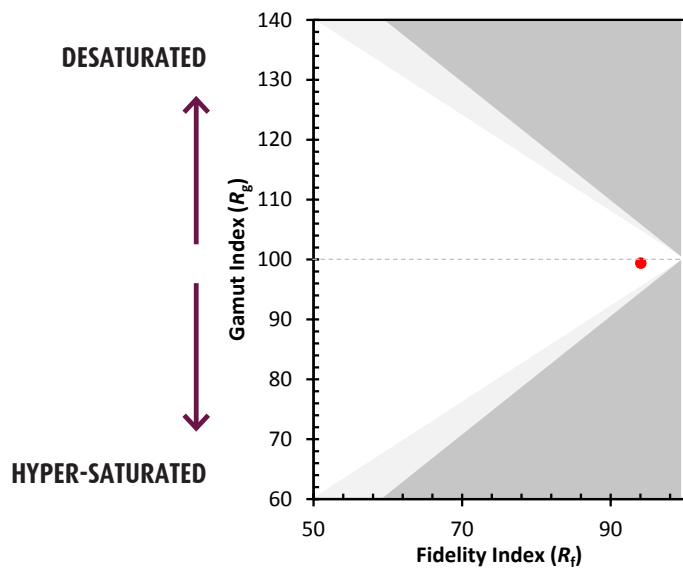

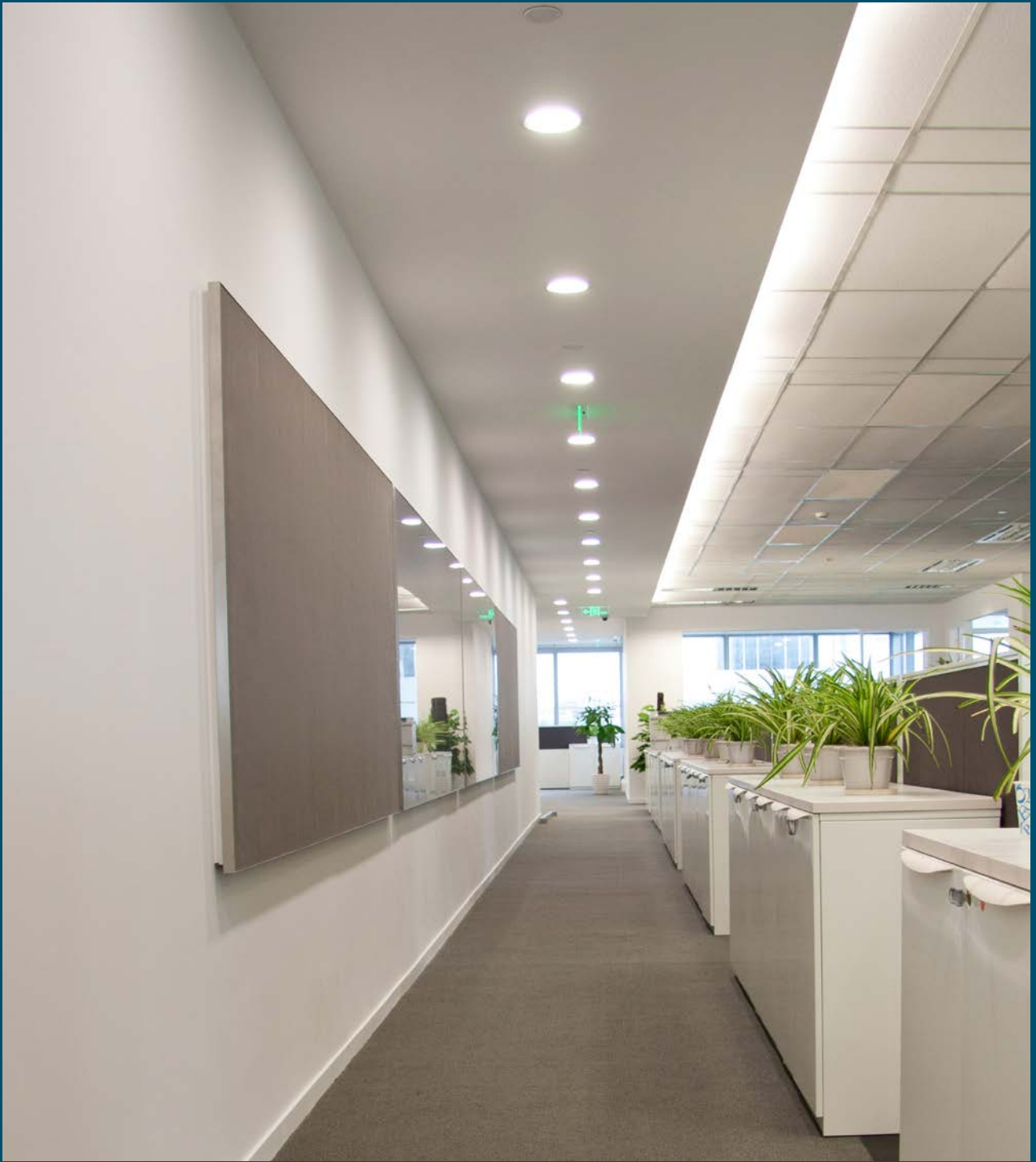

Indoor

DOWNLIGHTS

NEW



28 BASIC

LESELI CCT



30 BASIC

LESELI



32 BASIC

LESELI
HIGH POWER



34 BASIC

LESELI
REFLECTOR

NEW



38 BASIC

LESELI DS
SLIM



40 BASIC

LESELI
SLIM



44 PLUS

RTF

NEW



46 PRO

HELIOS IP65 CCT



48 PRO

HELIOS IP65

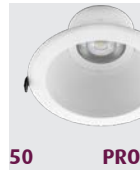

50 PRO

HELIOS UGR

NEW



52 PRO

LESELI Q PRO

MINI DOWNLIGHTS

NEW



54 PRO

LESELI MINI PRO

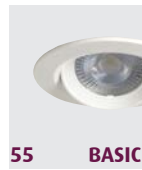

55 BASIC

LESELI MINI

LESELI DOWNLIGHT CCT



110°



12W
Ø125mm



22W/30W
Ø200mm

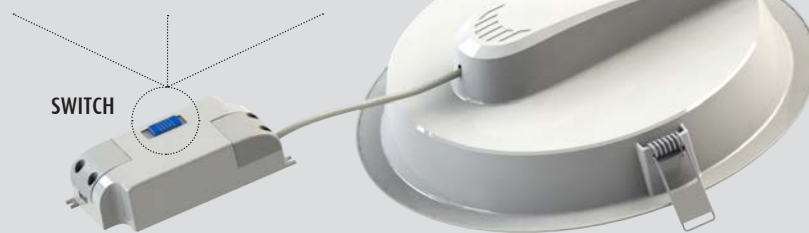
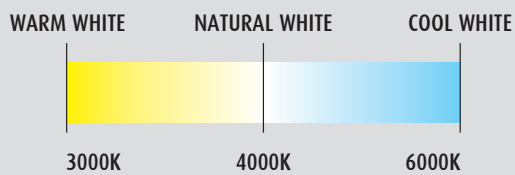

SWITCH

REAL LUMENS

Luminous Flux Data is REAL. Values are measured on actual use conditions. Nominal values of the LED source are not stated.

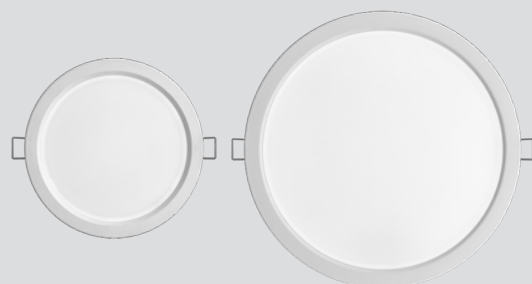

Ø 140 MM

Ø 216MM

LESELI DOWNLIGHT CCT

TYPE

LED source with SMD technology and high efficiency chip integrated into a recessed luminaire. Remote power supply equipped with a dip-switch to select the colour temperature.

CHARACTERISTICS

The deep recess of the light source combined with the advanced lens technology ensures glare ratings from UGR<11 to UGR<19. Applications include offices or places of work where computer screens are used and low glare is essential. A sealed light source provides easy maintenance and cleaning.

MOUNTING

Complete with springs for easy fastening into false ceilings. Cable (1 m) with IP65 quick connector.

MATERIALS

Thermally conductive body; extremely light and manageable.

FLICKER FREE

Providing greater visual comfort, improved definition of detail and reduction of stress.

BASIC	220-240V 50/60Hz	Ra>80		25000h L70 B20	IP20 VI IP43 VO		-25° +35°C		G3		A++ A+ A	Risk Group 1
--------------	---------------------	-------	--	-------------------	--------------------	--	---------------	--	-----------	--	----------------	-----------------

	art.	W	lm	cd	K	PF		Ø	L			
New	DT40L1CCT	12	1200*	430	3000-4000-6000	0,5	110°	140	54	96	8011905	955441 30
New	DT80L1CCT	22	2200*	770	3000-4000-6000	0,5	110°	216	58	214	953133	10
New	DT80L1CCTHP	30	3000*	1050	3000-4000-6000	0,9	110°	216	58	214	953126	10

*the lumen and power data indicated refers to the 4000K colour temperature.

• Minimum Order Quantity

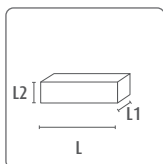
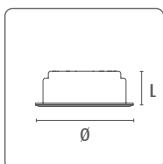

DRIVER:
L= 97.9 mm
L1= 45 mm
L2= 24 mm



Cut hole

12W = Ø 125 mm ± 2 mm
22W = Ø 200 mm ± 2 mm
30W = Ø 200 mm ± 2 mm

For the photometrics see the special section or consult the web site.

LESELI DOWNLIGHT



8W
Ø70mm



15W
Ø120mm



24W
Ø200mm

REAL LUMENS

Luminous Flux Data is REAL. Values are measured on actual use conditions. Nominal values of the LED source are not stated.



Ø 230 MM



Ø 150 MM



Ø 85 MM

LESELI DOWNLIGHT

TYPE

LED source with SMD technology and high efficiency chip integrated into a recessed luminaire.

CHARACTERISTICS

Soft satin effect polycarbonate anti-glare diffuser. Non-removable internal power supply.

MOUNTING

Complete with springs for easy fastening into false ceilings. Cable (1 m) with IP65 quick connector.

MATERIALS

Thermally conductive body; extremely light and manageable.

BASIC	220-240V 50/60Hz	Ra>80		25000h L70 B20	IP20 VI IP43 VO		-25° +35°C		G3		A++ A+ A	Risk Group 1
--------------	---------------------	-------	--	-------------------	--------------------	--	---------------	--	-----------	--	----------------	-----------------

art.	W	lm	cd	K	PF		Ø	L				
D30730*	8	600	230	3000	0,5	120°	85	30	75	80119058	46374	6
D30740	8	600	230	4000	0,5	120°	85	30	75		43182	6
D30760*	8	600	230	6000	0,5	120°	85	30	75		62770	6
D41530*	15	1400	630	3000	0,90	90°	150	60	350		46404	6
D41540	15	1400	630	4000	0,90	90°	150	60	350		43199	6
D41560*	15	1400	630	6000	0,90	90°	150	60	350		63104	6
D82530*	24	2200	1010	3000	0,94	90°	230	61	455		46435	6
D82540	24	2200	1010	4000	0,94	90°	230	61	455		43205	6
D82560*	24	2200	1010	6000	0,94	90°	230	61	455		62794	6

* To be discontinued

• Minimum Order Quantity

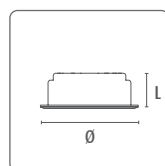

Cut hole

8W = Ø 70 mm ± 2 mm
15W = Ø 120 mm ± 2 mm
24W = Ø 200 mm ± 2 mm

For the photometrics see the special section or consult the web site.

LESELI HIGH POWER

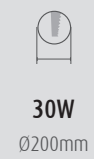

REAL LUMENS

Luminous Flux Data is REAL. Values are measured on actual use conditions. Nominal values of the LED source are not stated.



Ø 230 MM



L= 230 MM

LESELI HIGH POWER

TYPE

LED source with SMD technology and high efficiency chip integrated into a recessed luminaire.

CHARACTERISTICS

High power source. Soft satin effect polycarbonate anti-glare diffuser. Non-removable internal power supply.

MOUNTING

Complete with springs for easy fastening into false ceilings. Cable (1 m) with IP65 quick connector.

MATERIALS

Thermally conductive body; extremely light and manageable.

BASIC	220-240V 50/60Hz	Ra>80	25000h L70 B20	IP20 VI IP43 VO		-25° +35°C		G3		Risk Group 1
--------------	---------------------	-------	-------------------	--------------------	--	---------------	--	-----------	--	-----------------



art.	W	lm	cd	K	PF		L	L1	L2			
D3040HPQ*	30	3100	1400	4000	0,95	90°	60	230	230	455	80119058	6

* To be discontinued



art.	W	lm	cd	K	PF		L	L1	L2			
D3030HPQ-D*	30	2700	930	3000	0,95	90°	60	230	230	455	80119058	6

Dimmable (TRIAC, LEADING EDGE). List of Dimmers on www.duralamp.it

* To be discontinued



art.	W	lm	cd	K	PF		L	L1	L2			
D83040HPT	30	3100	1400	4000	0,95	90°	230	60		455	80119058	6



art.	W	lm	cd	K	PF		L	L1	L2			
D83030HPT-D	30	2900	1200	3000	0,95	90°	230	60		455	80119058	6

Dimmable (TRIAC, LEADING EDGE). List of Dimmers on www.duralamp.it

• Minimum Order Quantity

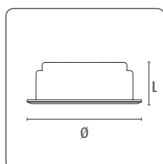
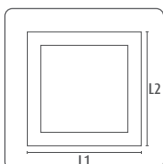

Cut hole

30W = Ø 200x200 mm ± 2 mm
30W = Ø 200 mm ± 2 mm

For the photometrics see the special section or consult the web site.

LESELI REFLECTOR



15W
Ø125mm



25W/30W
Ø200/215mm



APPLICATIONS

Common areas, receptions, corridors,
meeting rooms, offices, shops,
shopping areas

REAL LUMENS

Luminous Flux Data is REAL. Values are measured on actual use conditions. Nominal values of the LED source are not stated.

LESELI REFLECTOR

TYPE

LED source integrated into a recessed fixture equipped with a reflector.

CHARACTERISTICS

Reduced glare for better visual comfort.
Non-removable internal power supply.
Controlled light emission, ideal for general lighting of environments.

MATERIALS

Heat conducting plastic body; extremely light and easy to handle. White ring.

MOUNTING

Complete with springs for easy fastening into false ceilings. Cable (1 m) with IP65 quick connector.

NB

Luminaire is Non-Dimming. Connection to mains is with a screw terminal



BASIC	220-240V 50/60Hz	Ra 80		25000h L70 B20	IP20 VI IP43 VO		-25° +35°C			A++ A+ A	Risk Group 1
--------------	---------------------	-------	--	-------------------	--------------------	--	---------------	--	--	----------------	-----------------

art.	W	lm	cd	K		PF	Ø	L			
D41530A*	15	1300	900	3000	70°	0,95	150	81	255	8011905	6
D41540A	15	1300	900	4000	70°	0,95	150	81	255	854959	6
D41560A*	15	1300	900	6000	70°	0,95	150	81	255	863104	6
D82530A*	25	1900	1300	3000	70°	0,95	230	102	450	854935	6
D82540A	25	1900	1300	4000	70°	0,95	230	102	450	854928	6
D82560A*	25	1900	1300	6000	70°	0,95	230	102	450	863111	6
D83030A*	30	2400	1850	3000	70°	0,94	230	102	450	860899	6
D83040A	30	2400	1850	4000	70°	0,94	230	102	450	860905	6
D83060A*	30	2400	1850	6000	70°	0,94	230	102	450	903268	6

• Minimum Order Quantity

* To be discontinued

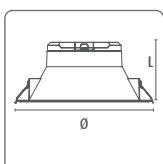

Cut hole

15W = Ø 125 mm ± 2 mm
25W/30W = Ø 200/215 mm ± 2 mm

For the photometrics see the special section or consult the web site.





LESELI REFLECTOR

4000K

LESELI SLIM DS



120°



105x105mm
203x203mm
277x277mm



Diecast aluminium body



Ø105
Ø203
Ø280



REAL LUMENS

Luminous Flux Data is REAL. Values are measured on actual use conditions. Nominal values of the LED source are not stated.

LESELI SLIM DS

TYPE

Ultra slim LED downlights with SMD technology and a high-efficiency chip.

CHARACTERISTICS

Downlights with extremely limited width and remote driver.

MOUNTING

Complete with springs for easy fastening into false ceilings. Surface/ceiling mounting options available with frame accessories.

MATERIALS

High dissipation die-cast aluminum body with anti-yellowing PC screen. Extremely lightweight for use in any false ceilings.



BASIC	110-240V 50/60Hz	Ra>80		15000h L70 B20	IP20 VI IP43 VO		-25° +35°C		G2		Risk Group 0
--------------	---------------------	-------	--	-------------------	--------------------	--	---------------	--	-----------	--	-----------------

	art.	Photo	W	lm	cd	K	PF		Ø	L2			8011905	
New	DS04L130T	1	6	310	88	3000	0,5	120°	120	8,5	110		954871	40
New	DS04L140T	1	6	330	93	4000	0,5	120°	120	8,5	110		954888	40
New	DS04L160T	1	6	350	99	6000	0,5	120°	120	8,5	110		954895	40
New	DS08L130T	1	18	1230	340	3000	0,5	120°	225	8,5	280		954901	20
New	DS08L140T	1	18	1300	360	4000	0,5	120°	225	8,5	280		954918	20
New	DS08L160T	1	18	1360	378	6000	0,5	120°	225	8,5	280		954925	20
New	DS10L130T	1	24	1710	475	3000	0,5	120°	295	8,5	480		954932	10
New	DS10L140T	1	24	1800	500	4000	0,5	120°	295	8,5	480		954949	10
New	DS10L160T	1	24	1890	525	6000	0,5	120°	295	8,5	480		954956	10

	art.	Photo	W	lm	cd	K	PF		L	L1	L2			8011905	
New	DS04L130Q	2	6	310	88	3000	0,5	120°	120	120	8,5	130		954963	40
New	DS04L140Q	2	6	330	93	4000	0,5	120°	120	120	8,5	130		954970	40
New	DS04L160Q	2	6	350	99	6000	0,5	120°	120	120	8,5	130		954987	40
New	DS08L130Q	2	18	1230	340	3000	0,5	120°	225	225	8,5	340		954994	20
New	DS08L140Q	2	18	1300	360	4000	0,5	120°	225	225	8,5	340		955007	20
New	DS08L160Q	2	18	1360	378	6000	0,5	120°	225	225	8,5	340		955014	20
New	DS10L130Q	2	24	1710	475	3000	0,5	120°	290	290	8,5	610		955021	10
New	DS10L140Q	2	24	1800	500	4000	0,5	120°	290	290	8,5	610		955038	10
New	DS10L160Q	2	24	1890	525	6000	0,5	120°	290	290	8,5	610		955045	10

DIMMABILITY: LESELI SLIM DS can be used with multi-current dimming power supply, code DELT400-M.
3 HOUR STANDBY LIGHTING. Can be used with Kit: KTEMRO3

Available from September

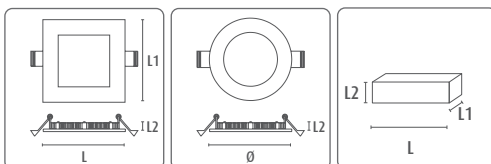

DRIVER 6W-18W:

L= 88 mm
L1= 38 mm
L2= 22 mm

DRIVER 24W:

L= 99 mm
L1= 40 mm
L2= 24 mm



Cut hole

6W = Ø 105 mm ± 2 mm
6W = 105x105 mm ± 2 mm
18W = Ø 203 mm ± 2 mm
18W = 203x203 mm ± 2 mm
22W = Ø 280 mm ± 2 mm
22W = 277x277 mm ± 2 mm

• Minimum Order Quantity

For the photometrics see the special section or consult the web site.

LESELI SLIM



120°



Ø113



114x109mm



Ø208



188x183mm

ACCESSORIES FOR CEILING/SURFACE INSTALLATION



REAL LUMENS

Luminous Flux Data is REAL. Values are measured on actual use conditions. Nominal values of the LED source are not stated.

LESELI SLIM

TYPE

Ultra slim LED downlights with SMD technology and a high-efficiency chip.

CHARACTERISTICS

Downlights with extremely limited width and remote driver.

MOUNTING

Complete with springs for easy fastening into false ceilings. Surface/ceiling mounting options available with frame accessories.

MATERIALS

Heat resistant plastic with high dissipation body. Extremely lightweight for use in any false ceilings.



BASIC	220-240V 50/60Hz	Ra>80		25000h L70 B20	IP20 VI IP43 VO		-25° +35°C		G3	A++ A+ A	Risk Group 0
--------------	---------------------	-------	--	-------------------	--------------------	--	---------------	--	-----------	-------------------------------------	-----------------



art.	W	lm	cd	K	PF		Ø	L			
D41540SL2	6	420	120	4000	0,52	120°	128	26	128	80119058	60912 10
D82540SL2	18	1400	390	4000	0,52	120°	228	26	290	80119058	60936 10



art.	W	lm	cd	K	PF		L	L1	L2			
D41540QSL2	6	420	120	4000	0,52	120°	128	128	26	140	80119058	60929 10
D82540QSL2	18	1400	390	4000	0,52	120°	202	202	26	300	80119058	60943 10

• Minimum Order Quantity

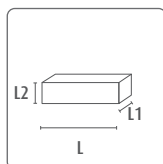
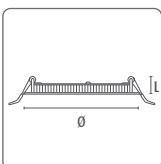

DRIVER:

L= 68 mm
L1= 34 mm
L2= 22 mm



Cut hole



6W = Ø 113 mm ± 2 mm
6W = 114x109 mm ± 2 mm
18W = Ø 208 mm ± 2 mm
18W = 188x183 mm ± 2 mm

For the photometrics see the special section or consult the web site.



LESELI SLIM ACCESSORIES

IP40

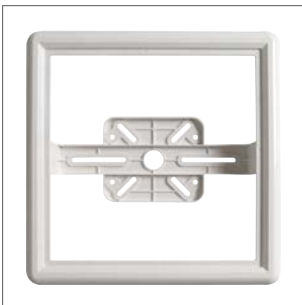

art		Ø	h	 80119058	
KTSL2	Accessory for surface mounting	168	36	60967	1
KT8SL2	Accessory for surface mounting	265	36	61544	1



art		L	h	 80119058	
KTQSL2	Accessory for surface mounting Q128	168x168	36	60950	1
KTQ8SL2	Accessory for surface mounting Q202	242x242	36	61551	1



LESELI
4000K

RTF DOWNLIGHTS



15W
Ø125mm



24W
Ø215mm



15W = REPLACES 2X11W FLUORESCENT
24W = REPLACES 2X26W FLUORESCENT

REAL LUMENS

Luminous Flux Data is REAL. Values are measured on actual use conditions. Nominal values of the LED source are not stated.

RTF DOWNLIGHTS

TYPE

High efficiency SMD LED sources LED source integrated in downlight luminaries.

CHARACTERISTICS

Line of fixtures in continuous technological evolution.

MOUNTING

Complete with springs for easy fastening into false ceilings.

MATERIALS

Aluminium finned dissipation body. White ring with a chrome flux recuperator

NB

Connection to mains with free wires. RTF 15W and 24W: the power supply can be separated from the body and moved to reduce the width of the fixture.

PLUS	100-240V 50/60Hz	Ra>80		30000h L70 B20	IP20 VI IP43 VO		-25° +35°C			A++ A+ A	Risk Group 0	
art.	W	lm	cd	K	PF		Ø	L				
D407830	15	1400	700	3000	0,90	120°	135	80*	0,276	80119058	18	
D407840	15	1400	730	4000	0,90	120°	135	80°	0,276	33534	18	
D815830	24	2500	700	3000	0,90	120°	236	97	0,780	33305	12	
D815840	24	2600	1100	4000	0,90	120°	236	97*	0,780	33527	12	

The height may be reduced by 30mm by installing the power supply sideways.

DIMMABILITY: RTF can be used with multi-current dimming power supply, code DELT40D-M.
3 HOUR STANDBY LIGHTING. Can be used with Kit: KTEMRO3

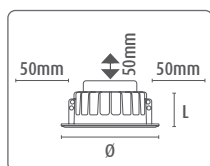

Cut hole

15W = Ø 125 mm ± 2 mm
24W = Ø 215 mm ± 2 mm

For the photometrics see the special section or consult the web site.

HELIOS IP65 CCT



Die-cast aluminium body

Remote driver

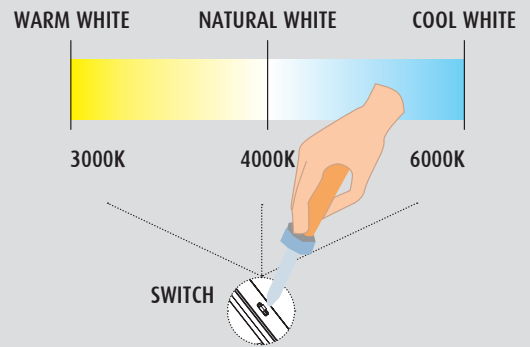

REAL LUMENS
Luminous Flux Data is REAL. Values are measured on actual use conditions. Nominal values of the LED source are not stated.

Ø 230MM
8"

Ø 140MM
4"

Ø 100MM
3"

HELIOS IP65 CCT

TYPE

High efficiency SMD LED sources LED source integrated in a Class III IP65 downlight fixture, Ra90, 50000 hours. Remote power supply equipped with a dip-switch to select the colour temperature.

CHARACTERISTICS

IP65 fixture both optical/front side and the back/component side; IP20 remote driver included in the package. Remote power supply equipped with a dip-switch to select the colour temperature. Flicker free.

MOUNTING

Complete with springs for easy fastening into false ceilings. Cable (1 m) with IP65 quick connector.

MATERIALS

Aluminium finned dissipation body.

FLICKER FREE

Providing greater visual comfort, improved definition of detail and reduction of stress.

PRO	220-240V 50/60Hz	Ra>90		50000h L70 B20	IP65		-25° +45°C		G5/h24	A++ A+ A	Risk Group 1
------------	---------------------	-------	--	-------------------	------	--	---------------	--	--------	----------------	--------------

art.	W	lm	cd	K	PF		Ø	L			8011905	
New DH30L2EXCCT	7	560*	250	3000-4000-6000	0,55	90°	100	51	240		941260	36
New DH40L2EXCCT	12	960*	420	3000-4000-6000	0,55	90°	140	64	440		941277	27
New DH80L2EXCCT	40	3200*	1400	3000-4000-6000	0,94	90°	230	73	1040		941284	12

*the lumen and power data indicated refers to the 4000K colour temperature.

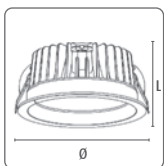

Cut hole
 7W = 85mm ± 2 mm
 12W = 125mm ± 2 mm
 40W = 210mm ± 2 mm

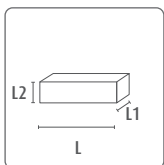

DRIVER 3": DRIVER 4": DRIVER 8":
 L= 69,8 mm L= 88 mm L= 132 mm
 L1= 32,8 mm L1= 38 mm L1= 45 mm
 L2= 20,5 mm L2= 22,5 mm L2= 27 mm

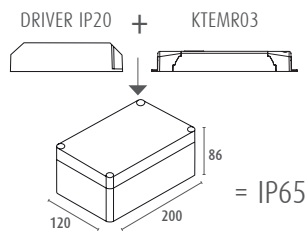

See the accessories page:

Anti-fall safety wire kit



For the photometrics see the special section or consult the web site.

HELIOS IP65



Die-cast aluminium body

Remote driver

REAL LUMENS

Luminous Flux Data is REAL. Values are measured on actual use conditions. Nominal values of the LED source are not stated.

Ø 230MM
8"

Ø 140MM
4"

Ø 100MM
3"

HELIOS IP65

TYPE

High efficiency SMD LED source integrated into a Class III IP65 downlight fixture.

CHARACTERISTICS

IP65 fixture both optical/front side and the back/component side; IP20 remote driver included in the package.

MOUNTING

Complete with springs for easy fastening into false ceilings. Cable (1 m) with IP65 quick connector.

MATERIALS

Aluminium finned dissipation body.

FLICKER FREE

Providing greater visual comfort, improved definition of detail and reduction of stress.

PRO	220-240V 50/60Hz	Ra>90		50000h L70 B20	IP65		-25° +45°C		G5/h24	A++ A+ A	Risk Group 1
------------	---------------------	-------	--	-------------------	------	--	---------------	--	--------	----------------	-----------------

art.	W	lm	cd	K	PF		Ø	L			
DH30L130EX	7	590	250	3000	0,9	90°	100	51	240	8011905	36
DH30L140EX	7	590	250	4000	0,9	90°	100	51	240	937461	36
DH40L130EX	12	960	420	3000	0,9	90°	140	64	440	937454	27
DH40L140EX	12	960	420	4000	0,9	90°	140	64	440	937447	27
DH80L130EX	40	3200	1400	3000	0,94	90°	230	73	1040	937430	12
DH80L140EX	40	3200	1400	4000	0,94	90°	230	73	1040	937423	12

DIMMABILITY: HELIOS IP65 12W can be used with multi-current dimming power supply, code DELT40D-M; HELIOS IP65 40W can be used with multi-current dimming power supply, code DELT40D-M or DELT40C-M.
3 HOUR STANDBY LIGHTING. Can be used with Kit: KTEMRO3

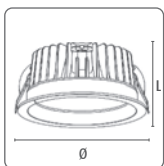

Cut hole

7W = 85mm ± 2 mm
12W = 125mm ± 2 mm
40W = 210mm ± 2 mm

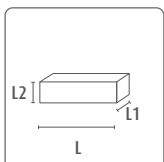

DRIVER 3": DRIVER 4": DRIVER 8":

L= 69.8 mm L= 88 mm L= 132 mm
L1= 32.8 mm L1= 38 mm L1= 45 mm
L2= 20.5 mm L2= 22.5 mm L2= 27 mm

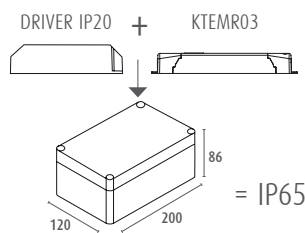

See the accessories page:

Anti-fall safety wire kit



For the photometrics see the special section or consult the web site.

HELIOS UGR RECESSED FIXTURES



UGR, LOW GLARE, ALUMINIUM BODY, RA >90

Ideal replacement for existing fittings using halogen lamps.

9W
Ø65mm



UGR<19

14W
Ø100mm



UGR<15

28W
Ø150mm



UGR<11

37W
Ø200mm



UGR<13



Ø 230 MM
8"



Ø 172MM
6"



Ø 118MM
4"



Ø 82MM
2,5"

HELIOS UGR RECESSED FIXTURES

TYPE

LED source with COB technology and an integrated high efficiency chip in a low glare UGR recessed light fixture.

CHARACTERISTICS

The deep recess of the light source combined with the advanced lens technology ensures glare ratings from UGR<11 to UGR<19. Applications include offices or places of work where computer screens are used and low glare is essential. A sealed light source provides easy maintenance and cleaning.

MOUNTING

Quick coupling system to false ceilings using springs.

MATERIALS

Aluminium body; extremely light and easy to manoeuvre.

FLICKER FREE

Providing greater visual comfort, improved definition of detail and reduction of stress.

PRO	220-240V 50/60Hz	Ra>90		50000h L80 B20	IP20 VI IP43 VO	UGR<11 UGR<13 UGR<15 UGR<19		-25° +45°C		G5/h24	A++ A+ A	Risk Group 1
------------	---------------------	-------	--	-------------------	--------------------	--------------------------------------	--	---------------	--	--------	----------------	-----------------

art.	W	lm	cd	K	PF	UGR		Ø	L			
DH25L130	9	850	1820	3000	0,95	19	36°	82	67	100	8011905	50
DH25L140	9	850	1820	4000	0,95	19	36°	82	67	100	936808	50
DH40L130	14	1450	3800	3000	0,95	15	36°	118	78	80	936815	50
DH40L140	14	1450	3800	4000	0,95	15	36°	118	78	80	936822	50
DH60L130	28	2800	7250	3000	0,95	11	36°	172	106	220	936839	4
DH60L140	28	2800	7250	4000	0,95	11	36°	172	106	220	936846	4
DH80L130	37	3700	10300	3000	0,95	13	36°	230	140	400	936853	4
DH80L140	37	3700	10300	4000	0,95	13	36°	230	140	400	936860	4

DIMMABILITY: HELIOS UGR 14W can be dimmed using multi-current dimming power supply, code DELT40D-M; HELIOS UGR 28W and 37W can use code DELT40D-M or DELT40C-M.

3 HOUR STANDBY LIGHTING. Can be used with Kit: KTEMRO3

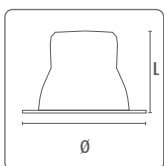

Cut hole
 9W = Ø 65 mm ± 2 mm
 14W = Ø 100 mm ± 2 mm
 28W = Ø 150 mm ± 2 mm
 37W = Ø 200 mm ± 2 mm

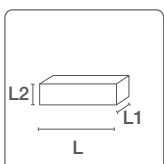

DRIVER 2,5":	DRIVER 4":	DRIVER 6":	DRIVER 8":
L= 100 mm	L= 88 mm	L= 117 mm	L= 117 mm
L1= 40 mm	L1= 40 mm	L1= 43 mm	L1= 43 mm
L2= 25 mm	L2= 23 mm	L2= 24 mm	L2= 24 mm

REAL LUMENS

Luminous Flux Data is REAL. Values are measured on actual use conditions. Nominal values of the LED source are not stated.

For the photometrics see the special section or consult the web site.

LESELI-Q PRO



Ø205mm

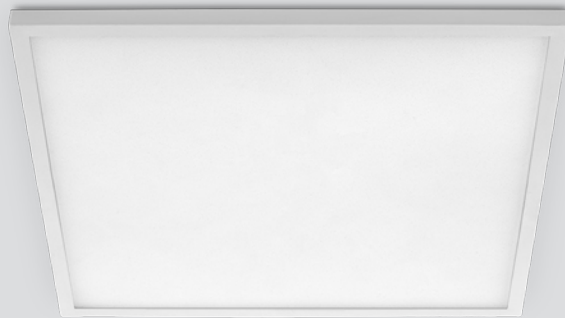

Recessed version
W1SQ30-W



TRACK version
W1SQT30-W

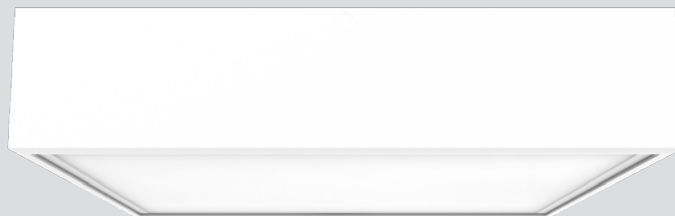

Ceiling mounted version:
W1SQ30-W + PLAFOW1SQ-W

REAL LUMENS

Luminous Flux Data is REAL. Values are measured on actual use conditions. Nominal values of the LED source are not stated.

LESELI-Q PRO

TYPE

High efficiency SMD LED sources integrated into the body of the light fixture available in 3 different versions: recessed, ceiling for surface installation and with a track attachment.

CHARACTERISTICS

The possibility to use the same fixture with different installation types makes it possible to maintain a uniform aesthetic in different areas of the same space.

MOUNTING

Recessed: with a rapid fixing system to attach to the plasterboard ceiling using springs. Electrical connection and free wires.

Ceiling mounted: order the frame with separate code.

Electrical connection and free wires.

Track version: using its eurostandard compatible adapter.

MATERIALS

High dissipation die-cast aluminum body with anti-yellowing PC screen. Extremely lightweight for use in any false ceilings. White painted aluminum frame.

FLICKER FREE

Providing greater visual comfort, improved definition of detail and reduction of stress.

Back panel in finned aluminium for excellent heat dissipation



PRO	220-240V 50/60Hz	Ra>85		50000h L70	IP20 VI IP43 VO		-25° +45°C		G5/h24		A++ A+ A	Risk Group 0
------------	---------------------	-------	--	---------------	--------------------	--	---------------	--	---------------	--	-------------------------------------	-----------------

art.	W	lm	cd	K	PF		L	L1	L2			
New W1SQ30-W	26	2000	600	3000	0,9	120	223	223	34	700	8011905	1

art.	W	lm	cd	K	PF		L	L1	L2	L3			
New W1SQ30-W	26	2000	600	3000	0,9	120	223	223	43	71	740	955601	1



art.	L	L1	L4				
New PLAFOW1SQ-W	Surface mounting frame for W1SQ30 - white	229	229	50	420	959203	1

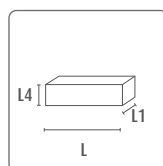
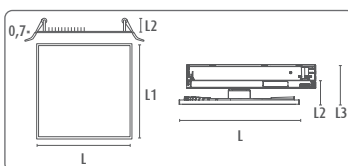

DRIVER:

L= 110 mm
L1= 48 mm
L2= 28 mm



Cut hole
26W = Ø 205 mm ± 2 mm

For the photometrics see the special section or consult the web site.

LESELI MINI PRO

TYPE

Recessed LED fixtures with integrated drivers.

CHARACTERISTICS

A fixed optic with a dichroic effect. The particular design of the lens ensures excellent diffusion of the light beam. Compact and easy to use. Flicker free.

MOUNTING

Complete with springs to affix easily into ceilings.

MATERIALS

Extruded powder coated aluminium body.



FLICKER FREE

Providing greater visual comfort, improved definition of detail and reduction of stress.

PRO	100-240V 50/60Hz	Ra>80		50000h L70 B20	IP20 VI IP23 VO		-25° +35°C		G5/h24	A++ A+ A	Risk Group 1
------------	---------------------	-------	--	-------------------	--------------------	--	---------------	--	--------	----------------	-----------------

art.	W	lm	cd	K		Ø	L			
New D306TWW	8	650	1740	3000	36°	85	55	182	80119058	20
New D306TNW	8	680	1820	4000	36°	85	55	182	941376	20

• Minimum Order Quantity

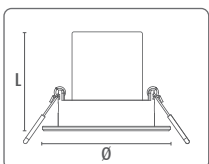

Cut hole

8W = Ø 68 mm ± 2 mm

For the photometrics see the special section or consult the web site.

LESELI MINI

TYPE

Low thickness, small size LED downlights.

CHARACTERISTICS

Compact and easy to install. Tilt Adjustability 30°. Special design of the lens ensures excellent light beam diffusion. Non removable internal power supply.

MOUNTING

Complete with springs for easy fastening into false ceilings.

MATERIALS

Heat resistant, anti-yellowing plastic body.



BASIC	100-240V 50/60Hz	Ra>80		15000h L70 B30	IP20 VI IP23 VO		-25° +35°C		G2		A++ A+ A	Risk Group 0
--------------	---------------------	-------	--	-------------------	--------------------	--	---------------	--	----	--	----------------	-----------------



art.	W	lm	cd	K		L	L1	L2			80119058	
D307QWW	7	620	700	3000	40°	90	90	45	83	62756	10	
D307QNW	7	650	735	4000	40°	90	90	45	83	60882	10	



art.	W	lm	cd	K		Ø	L2			80119058	
D307TWW	7	620	700	3000	40°	90	45	80	62763	10	
D307TNW	7	650	735	4000	40°	90	45	80	60875	10	

• Minimum Order Quantity

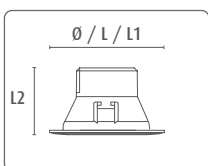

Cut hole

7W = Ø 72 mm ± 2 mm



For the photometrics see the special section or consult the web site.



Indoor

DOWNLIGHTS WITHOUT LAMP



58 **BASIC**

MULTI-OPTIC
RECESSED FIXTURE



59 **BASIC**

ZKRR RECESSABLE
RING: ADJUSTABLE
AND
WITH OPTIONAL
OPTICS

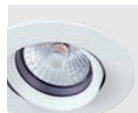

60 **BASIC**

ZK RECESSABLE
RINGS: FIXED IP65
AND ORIENTABLE
IP20



61 **BASIC**

ZK RECESSABLE RING:
IP20 FIXED

MULTI-OPTIC RECESSED FIXTURE

TYPE

Rectangular recessed fixture for two adjustable GU10 lamps.

CHARACTERISTICS

Widely used in retail installations, it meets the needs of those who prefer a recessed ceiling luminaire with replaceable lamps. It offers the advantage of having both multidirectional and adjustable light beams from + 15 ° to -15 ° in the vertical plane. Houses PAR16 lamps; compatible with all GU10 lamps in the Duralamp catalogue.

Max 30W.

MATERIALS

Body in black painted aluminium with silver colour frame.

MOUNTING

Recessed with the special galvanised aluminium springs. Complete with GU10 lamp holder

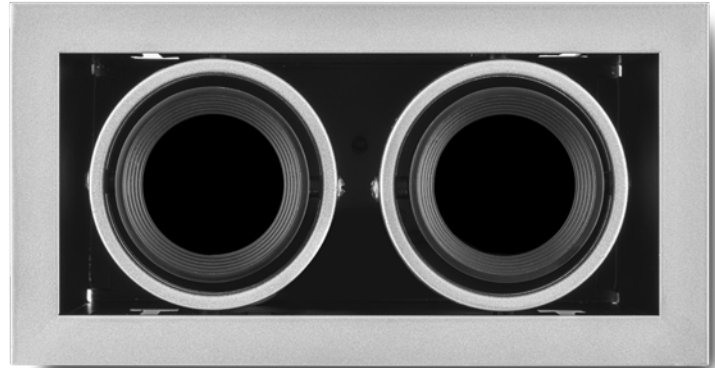

Lamps not included: Picture shows fitted with MULTI100 GU10.

BASIC	220-240V 50/60Hz	IP20 VI IP23 VO		-25° +45°C	G5/h24
--------------	---------------------	--------------------	---	---------------	--------

art.	L1	L2	L3	 8011905	
ZKR2-ST	108	210	125	935269	1

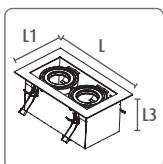

95x190mm

ZKRR RECESSABLE RING: ADJUSTABLE AND WITH OPTIONAL OPTICS

TYPE

Recessed orientable ring with interchangeable optional optics for MR16, PAR16 lamps and Module.

CHARACTERISTICS

The recessed ring, that allows an orientation of the source of 20°, can be fitted (snap on) with metal optics that can modify the lighting output by offering accent or antiglare solutions.

MATERIALS

Body and optics in painted metal body.

MOUNTING

Equipped with springs for quick installation.



The possibility to easily change the beam using the beam shapers, allows to obtain different effects with the same fixture: ideal in retail spaces.

The ZKRR ring mounts the lamp in a recessed position of 4 cm.

BASIC G5/h24

art.		Ø	L	8011905	10
ZKRR	Adjustable recessed ring - White colour	90	53	844059	10

To be completed with the wired lampholders code T053 and T010.

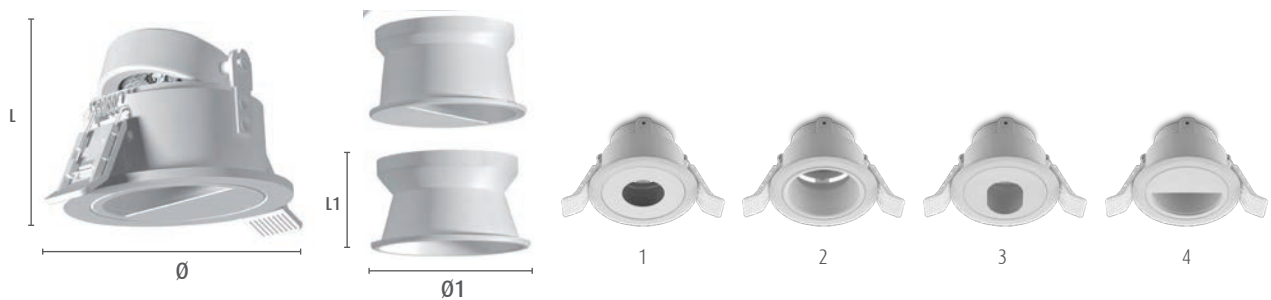

art.		Photo	Ø	Ø1	L	L1	8011905	10
ZK001	Spot effect beam shaper	1	90	68,5	53	36,7	844066	10
ZK002	Wide beam shaper	2	90	68,5	53	36,7	844073	10
ZK003	Side beam shaper	3	90	68,5	53	36,7	844080	10
ZK004	Wall washer	4	90	68,5	53	36,7	844097	10

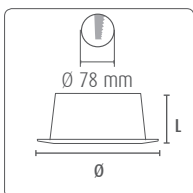

Cut hole

Ø 78 mm ± 2 mm

ZK RECESSABLE RINGS: FIXED IP65 AND ORIENTABLE IP20

TYPE

Recessed orientable ring with interchangeable optional optics for MR16, PAR16 lamps and Module. IP20 orientable version and IP65 fixed version.

CHARACTERISTICS

The same ring declined in two versions to fulfill different installation needs in the same environments. Ring for recessed installation of MR16 / PAR16 lamps complete with front screen.

MATERIALS

Painted metal body.

MOUNTING

Equipped with springs for quick installation.



IP65

ADJUSTABLE 30° IP20

BASIC G5/h24

IP20

art.		Ø/L1	L	80119058	
ZKRTB	Round white ring	90	33	36801	10
ZKRTG	Round grey ring	90	33	36818	10
ZKRQB	Square white ring	90	33	36825	10
ZKRQG	Square gray ring	90	33	36832	10



IP65

art.		Ø/L1	L	80119058	
ZKR65TB	IP65 Round white ring	90	33	36849	10
ZKR65TG	IP65 Round gray ring	90	33	36856	10
ZKR65QB	IP65 Square white ring	90	33	36863	10
ZKR65QG	IP65 Square gray ring	90	33	36870	10

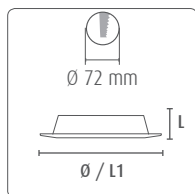

Ø 72 mm ± 2 mm

ZK RECESSABLE RING: IP20 FIXED

TYPE

Ring for recessed installation of MR16/PAR16 lamps, IP20.

CHARACTERISTICS

The spring type lamp holder allows this recessed mounting ring to be used with any type of lamp fitted with a front closure.

MATERIALS



White painted metal body.

MOUNTING

Equipped with springs for quick installation. To be completed with the wired lampholders code T053 and T010.



BASIC	IP20	G5/h24
--------------	------	--------

art.	Ø1	Ø	L	 80119058	
ZKRTB2	51	78	26	61483	10

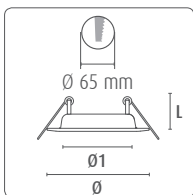

 Cut hole
Ø 65 mm ± 2 mm



Kit lampholder

art.		 80119058	
T053	Kit lampholder GU5,3 + terminal block	34388	4



art.		 80119058	
T010	Kit lampholder GU10 + terminal block	34371	4

• Minimum Order Quantity



Stand Vinality Cantine Briziarelli
Arch.: Studio architettura Miidesign

Indoor

TRACKLIGHT



64 PLUS

DURA BEAM
TRACK LIGHT



68 PRO

PROJECTOR
DURA TL



72 BASIC

TRACK PROJECTOR
FOR REPLACEABLE
LAMP



74

EUROSTANDARD
PLUS

DURA BEAM - TRACK LIGHT



Die-cast painted aluminium body.
Integrated electronic driver.

The graduated ring opens by unscrewing and the lens can be replaced with a click.

Optimised optics for power.

The essential design can be used everywhere

Minimum footprint with effectiveness of up to 90 lm/W

Ra >90

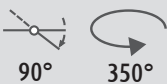

The centre of gravity always remains in axis with the track irrespective of where the projector is aimed.

Cylindrical section and very small diameter:
50 mm 60 mm 80 mm

12W 20W 30W

Can be equipped with several 'beam-cutting' accessories to meet different project needs:

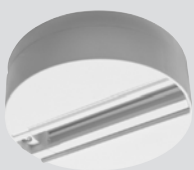

ADAPTER FOR SURFACE INSTALLATIONS



OPTIONAL LENSES

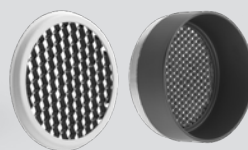

ANTI-GLARE LOUVRES

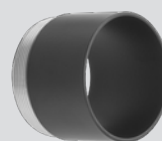

CUT OFF



ASYMMETRICAL CUT OFF

DURA BEAM - TRACK LIGHT

TYPE

Professional LED projectors for track mounting.

CHARACTERISTICS

Same shape with 3 different dimensions and power choices to cover all requirements. Can be used with Euro-standard Plus tracks as well as with other brands': Staff, Nordlux, Nordic, Global, etc.

OPTIC

High efficiency Ra>90 LED Chip on Board. Precision optics with dichroic effect lens. Adjustable from 0° to -90° on the vertical plane and 350° on the horizontal plane.

MATERIALS

Die-cast painted aluminium body; black or white colour.

MOUNTING

Onto an electrical track in 3 phases; fixtures equipped with a safety lock to fix to the tracks.

NB

Non Dimmable.

POWER SUPPLY

Electronic driver integrated in the fixture body.



PLUS	220-240V 50/60Hz	Ra>90		35000h L70 B20	IP20	-25° +35°C		G4		Risk Group 1
-------------	---------------------	-------	--	-------------------	------	---------------	--	----	--	-----------------

art.	W		lm	cd	K		∅	L	L1			
TB50L130-W	12		920	6100	3000	15°	50	136	136	305	936884	20
TB50L140-W	12		990	6600	4000	15°	50	136	136	305	936907	20
TB50L130-B	12		920	6100	3000	15°	50	136	136	305	936891	20
TB50L140-B	12		990	6600	4000	15°	50	136	136	305	936914	20
TB60L130-W	20		1700	3496	3000	36°	60	148	146	394	936921	20
TB60L140-W	20		1800	3700	4000	36°	60	148	146	394	936945	20
TB60L130-B	20		1700	3496	3000	36°	60	148	146	394	936938	20
TB60L140-B	20		1800	3700	4000	36°	60	148	146	394	936952	20
TB80L130-W	30		2500	5140	3000	36°	80	189	166	673	936969	10
TB80L140-W	30		2700	5550	4000	36°	80	189	166	673	936983	10
TB80L130-B	30		2500	5140	3000	36°	80	189	166	673	936976	10
TB80L140-B	30		2700	5550	4000	36°	80	189	166	673	936990	10

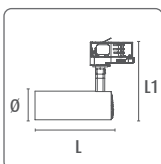

For the photometrics see the special section or consult the web site.

DURA BEAM - TRACK LIGHT ACCESSORIES

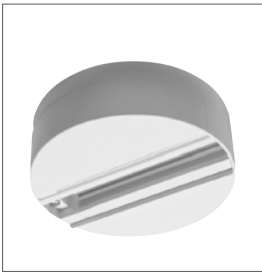

Adapter for surface installations

art		8007753		
1T2220	■	309284		1
1T2221	□	309277		1



Optional lenses

art		8011905		
KTB60LENS	∅ 60 - 24° - 10 pcs	937249		1
KTB80LENS	∅ 80 - 24° - 10 pcs	937256		1



Anti-glare grid

art		8011905	8011905		
KTB50AGL-B	■ 937010	KTB50AGL-W	□ 937003	∅ 50 - 5 pcs	1
KTB60AGL-B	■ 937034	KTB60AGL-W	□ 937027	∅ 60 - 5 pcs	1
KTB80AGL-B	■ 937058	KTB80AGL-W	□ 937041	∅ 80 - 5 pcs	1



'High' anti-glare grid

art		8011905	8011905		
KTB50AGL1-B	■ 937072	KTB50AGL1-W	□ 937065	∅ 50 - 5 pcs	1
KTB60AGL1-B	■ 937096	KTB60AGL1-W	□ 937089	∅ 60 - 5 pcs	1
KTB80AGL1-B	■ 937119	KTB80AGL1-W	□ 937102	∅ 80 - 5 pcs	1



Asymmetric cut off

art		8011905	8011905		
KTB50ACO-B	■ 937133	KTB50ACO-W	□ 937126	∅ 50 - 5 pcs	1
KTB60ACO-B	■ 937157	KTB60ACO-W	□ 937140	∅ 60 - 5 pcs	1
KTB80ACO-B	■ 937171	KTB80ACO-W	□ 937164	∅ 80 - 5 pcs	1

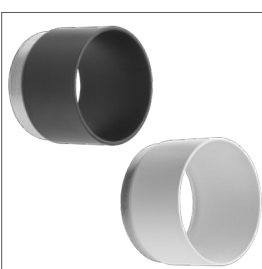

Cut off

art		8011905	8011905		
KTB50ACO1-B	■ 937195	KTB50ACO1-W	□ 937188	∅ 50 - 5 pcs	1
KTB60ACO1-B	■ 937218	KTB60ACO1-W	□ 937201	∅ 60 - 5 pcs	1
KTB80ACO1-B	■ 937232	KTB80ACO1-W	□ 937225	∅ 80 - 5 pcs	1



DURA BEAM

4000K

DURA TL - TRACK LIGHT



10W
SMALL



15W
MEDIUM



22W
MEDIUM



38W
LARGE

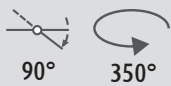

The centre of gravity
always remains in
axis with the track
irrespective of where the
projector is aimed.

ACCESSORIES FOR MEDIUM AND LARGE BODIES

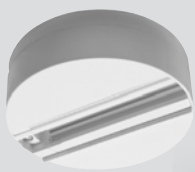

ADAPTER FOR
SURFACE
INSTALLATIONS



OPTIONAL LENSES



ANTI-GLARE LOUVRE



BARN DOOR
FLAPS



ASYMMETRICAL

DURA TL - TRACK LIGHT

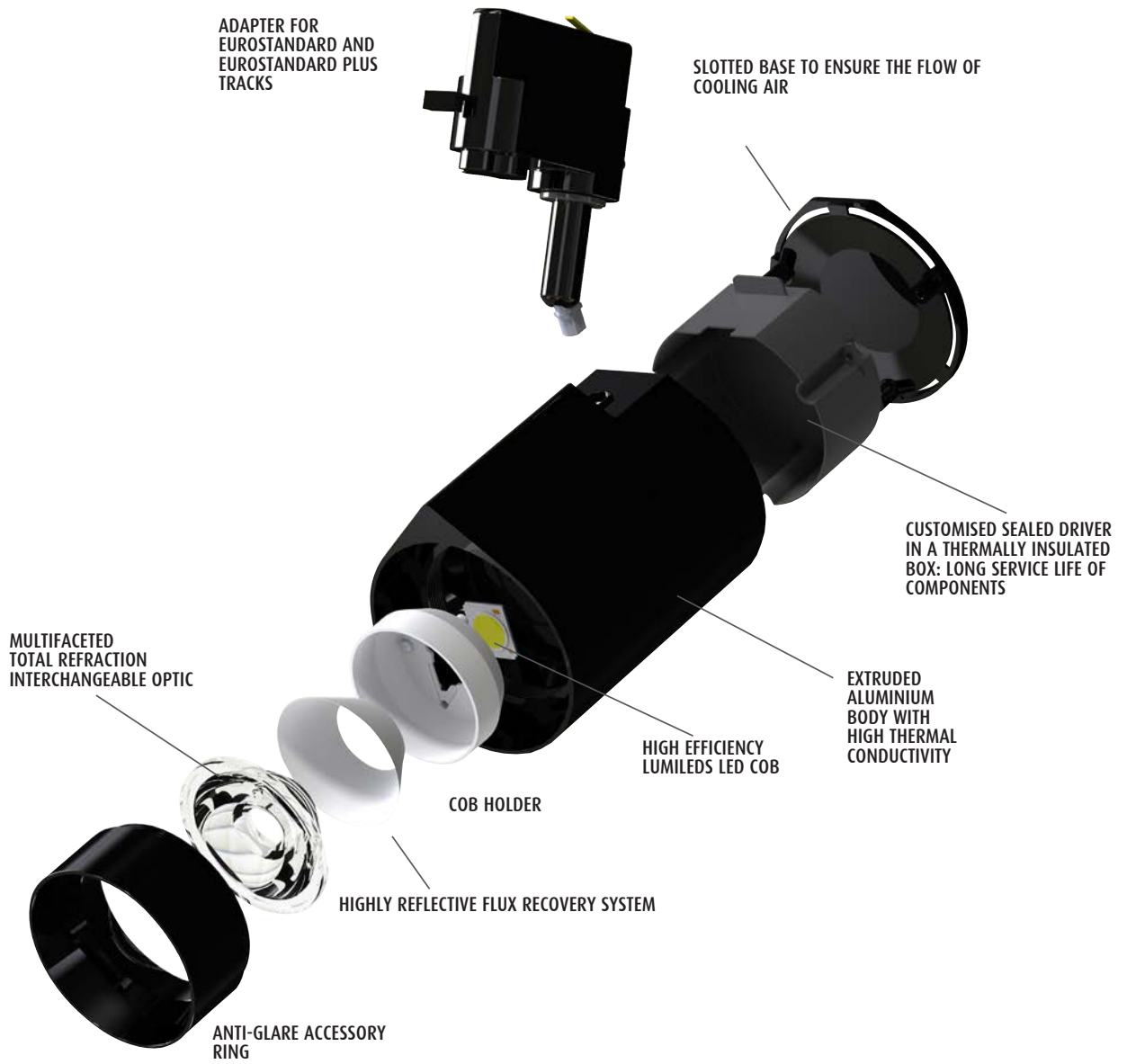

DURA TL - TRACK LIGHT

TYPE

Professional LED projectors for track mounting.

CHARACTERISTICS

Same shape with 3 different dimensions and power choices to cover all requirements. Can be used with Eurostandard Plus tracks as well as with other brands': Staff, Nordlux, Nordic, Global, etc.

OPTIC

High efficiency Ra>90 LED Chip on Board. Precision optics with dichroic effect lens. Adjustable from 0° to -90° on the vertical plane and 350° on the horizontal plane.

MATERIALS

Die-cast painted aluminium body; black or white colour.

MOUNTING

Onto an electrical track in 3 phases; fixtures equipped with a safety lock to fix to the tracks.



NB

Non Dimmable.
TRIAC (200-250V) dimmable version on request.

POWER SUPPLY

Electronic driver integrated in the fixture body.

PRO	110-240V 50/60Hz	Ra>85		50000h L70 B20	IP20	-25° +35°C		G5/h24		Risk Group 1
------------	---------------------	-------	--	-------------------	------	---------------	--	--------	--	-----------------

art.	W		lm	cd	K		Ø	L	L1			
TD10S-3K8L-MSP-W	10		855	2090	3000	24°	60	95	167	370	902674	20
TD10S-4K8L-MSP-W	10		900	2200	4000	24°	60	95	167	370	863173	20
TD10S-3K8L-MSP-B	10		855	2090	3000	24°	60	95	167	370	902667	20
TD10S-4K8L-MSP-B	10		900	2200	4000	24°	60	95	167	370	861865	20
TD15M-3K8L-FL-W	15		1235	1890	3000	40°	100	108	184	648	902681	10
TD15M-4K8L-FL-W	15		1300	1990	4000	40°	100	108	184	648	851699	10
TD15M-3K8L-FL-B	15		1235	1890	3000	40°	100	108	184	648	902698	10
TD15M-4K8L-FL-B	15		1300	1990	4000	40°	100	108	184	648	851705	10
TD22M-3K8L-FL-W	22		2185	3135	3000	40°	100	108	184	648	902711	10
TD22M-4K8L-FL-W	22		2300	3300	4000	40°	100	108	184	648	863241	10
TD22M-3K8L-FL-B	22		2185	3135	3000	40°	100	108	184	648	902704	10
TD22M-4K8L-FL-B	22		2300	3300	4000	40°	100	108	184	648	861872	10
TD38L-3K8L-FL-W	38		3800	5795	3000	40°	111	141	189	927	851668	10
TD38L-4K8L-FL-W	38		4000	6100	4000	40°	111	141	189	927	863197	10
TD38L-3K8L-FL-B	38		3800	5795	3000	40°	111	141	189	927	851682	10
TD38L-4K8L-FL-B	38		4000	6100	4000	40°	111	141	189	927	861896	10

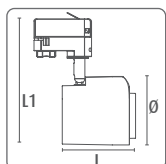

For the photometrics see the special section or consult the web site.

ACCESSORIES DURA TL - TRACK LIGHT



Adapter for surface installations

art		8007753	
1T2220		309284	1
1T2221		309277	1



Optional lenses

art			80119058	
TDM-LENS24	24° lens for MEDIUM BODY	24°	61254	10
TDM-LENS60	60° lens for MEDIUM BODY	60°	61261	10
TDL-LENS24	24° lens for LARGE BODY	24°	61308	10
TDL-LENS60	60° lens for LARGE BODY	60°	61315	10



Anti-glare louvre

art		80119058	
TDM-AGL	Anti-glare louvre for MEDIUM BODY	61278	6
TDL-AGL	Anti-glare louvre for LARGE BODY	61322	6

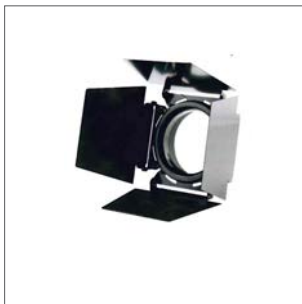

Barn door flaps

art		80119058	
TDM-BDF	Barn door flaps for MEDIUM BODY	61285	6
TDL-BDF	Barn door flaps for LARGE BODY	61339	6



Asymmetrical

art		80119058	
TDM-ACO	Asymmetric cut-off for MEDIUM BODY	61292	6
TDL-ACO	Asymmetric cut-off for LARGE BODY	61346	6

TRACK MOUNTING PROJECTOR FOR REPLACEABLE LAMP



CAN BE USED WITH



PAR20
L7105, L7105W



PAR30
L7106W, L7106



PAR38
L868W, L868



REFLECTED
L758WB



REFLECTED
L915WB



A60
DA6020W



A60
A6024W

TRACK MOUNTING PROJECTOR FOR REPLACEABLE LAMP

TYPE

Adjustable fitting complete with adaptor for track mounting and E27 lampholder.

CHARACTERISTICS

Satisfies the needs of those who prefer a track-mounted luminaire for replaceable lamps.
 Can be used with Eurostandard Plus tracks as well as with other brands': Staff, Nordlux, Nordic, Global, Nuco etc.
 Adjustable from +90° to -90° on the vertical plane and 350° on the horizontal plane.
 Suitable for PAR38 lamps: see the list of lamps that can be fitted. Max 30W.

MATERIALS

Die-cast painted aluminium body, white colour; steel adjustable arm.

MOUNTING

Mounting on an electrical track in 3 phases; fixtures equipped with a safety lock to fix to the tracks.

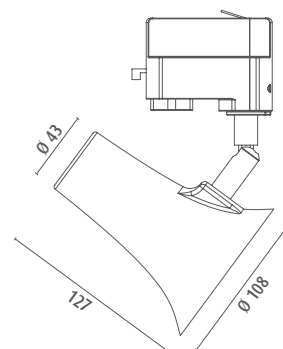

BASIC	IP20	-25° +35°C	G3
--------------	------	---------------	-----------

art.	MAX	Ø	L			
SP01-W	30W	108	127	277	8011905 935252	1



Adapter for surface installations

art			
1T2220		8007753 309284	1
1T2221		309277	1

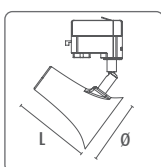

EUROSTANDARD PLUS

TYPE

Eurostandard Plus track from the Targetti collection. System is a 3 phase mixed system with two additional conductors intended to manage a general data signal (for example DALI, DMX). Electrified track in three lengths in extruded anodized aluminum or in extruded painted aluminium. Conductors in copper insulated in PVC.

MOUNTING

There are three possible installation systems: directly on false ceiling (using the needlepoints on the track and the suspension kit), on ceiling using a metal clip or hanging by a mounting kit.

POWER SUPPLY

Frequency: 50Hz.

Rated current and voltage: L1/L2/L3/N/ground 16A/440V + D+/D- 2x1A/50V FELV AC (DALI). Phase / phases power: 3,6kVA / 10,8kVA.

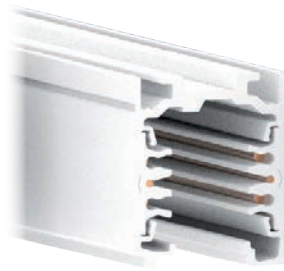

EUROSTANDARD
PLUS



TRACKS

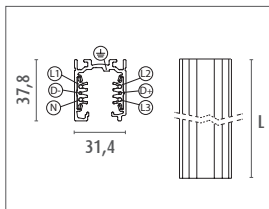

Standard

art.		L		
9000-1/B-ST	9000-1/W-ST	1000	1100	1
9000-2/B-ST	9000-2/W-ST	2000	2100	1
9000-3/B-ST	9000-3/W-ST	3000	3100	1

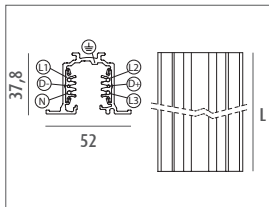

Recessed

art.		L		
9000-1/B-R	9000-1/W-R	1000	1100	1
9000-2/B-R	9000-2/W-R	2000	2200	1
9000-3/B-R	9000-3/W-R	3000	3400	1

END CAPS

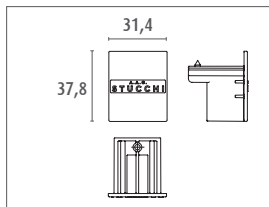

Dead end

art.			
9004/B	9004/W	1	

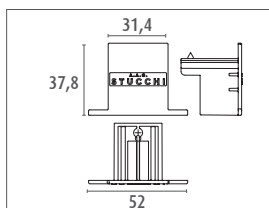

Dead end - recessed

art.			
9004-R/B	9004-R/W	1	

MOUNTING SYSTEMS

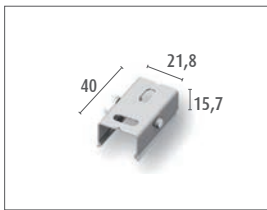

Ceiling mounting bracket

art.

S-9000/111



1

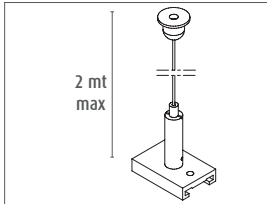

Mounting systems suspension

art.

S-9000KIT



1

POWER SUPPLY



Power supplies lateral polarity on the right

art.

9001/B



9001/W



1



Power supplies lateral polarity on the left

art.

9002/B



9002/W



1



Power supplies central

art.

9010/B



9010/W



1

LATERAL FEEDING SYSTEMS ACCESSORIES



Seal for lateral power supply

art.

S-9001/115-B



S-9001/115-W



1

PVC. for: 9001...; 9002...

ELECTRICAL CONNECTOR

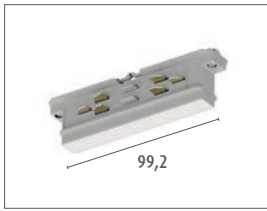

Connectors straight

art.



9003/B



9003/W



1

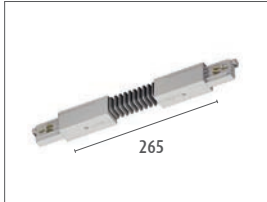

Connectors flexible

art.



9018/B



9018/W



1

Cannot be used for the recessed track

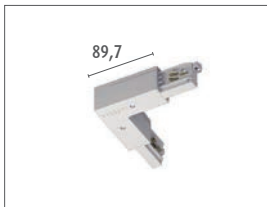

"L" joint internal polarity

art.



9011/B



9011/W



1



"L" joint external polarity

art.



9012/B



9012/W



1

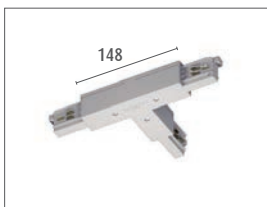

"T" joint external polarity

art.



9013/B



9013/W



SX

1

9014/B



9014/W



DX

1



"T" joint internal polarity

art.



9015/B



9015/W



SX

1

9016/B



9016/W



DX

1

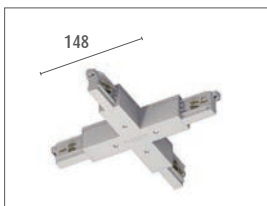

"X" joint

art.



9017/B



9017/W



1

Note: All joints except the linear joint can be used as power supply.

COVER PANELS FOR RECESSED TRACK

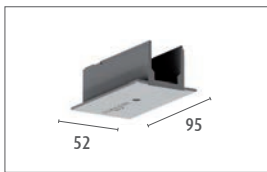

COVER false ceiling cover for lateral power supply.

art.



S-9001-R/6-B **S-9001-R/6-W**

1

Polycarbonate body for: 9001/...; 9002/...

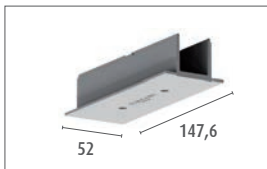

COVER false ceiling cover for central power supply

art.



S-9010-R/6-B **S-9010-R/6-W**

1

Polycarbonate body for: 9010/...;

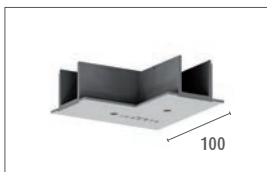

COVER "L" connector for false ceiling

art.



S-9011-R/6-B **S-9011-R/6-W**

1

Polycarbonate body for: 9011/...; 9012/...;

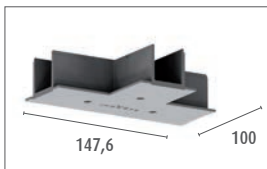

COVER "T" connector for false ceiling

art.



S-9013-R/6-B **S-9013-R/6-W**

1

Polycarbonate body for: 9013/...; 9014/...; 9015/...; 9016/...

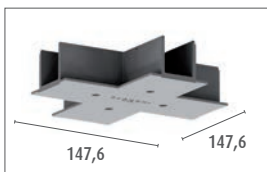

COVER "X" connector for false ceiling

art.



S-9017-R/6-B **S-9017-R/6-W**

1

Polycarbonate body for: 9017

ACCESSORIES

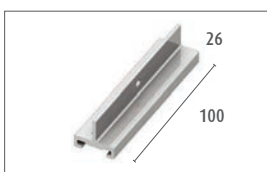

Rigid support bracket

art.



S-9000/123

1

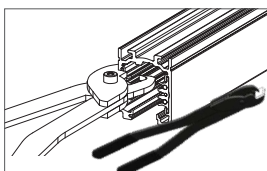

Tool for shearing conductors, to be used if it's necessary to cut the track during the installation.

art.



S-9000/T

1

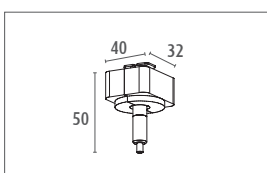

Suspension bracket

art.



S-9000/M-B-KIT **S-9000/M-W-KIT**

1

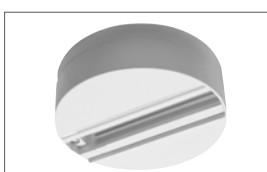

Adapter for surface installations

art



1T2220

309284

1

1T2221

309277

1

EUROSTANDARD PLUS

ELECTRICAL SCHEME

During the wiring the electrical scheme of picture must be followed.

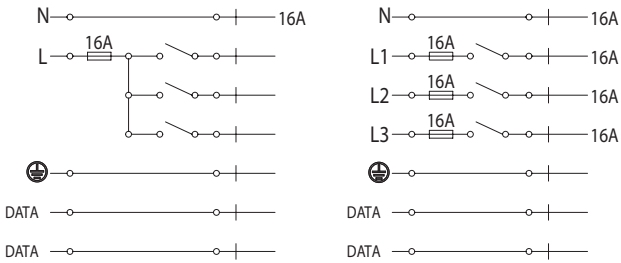

LOAD SCHEME

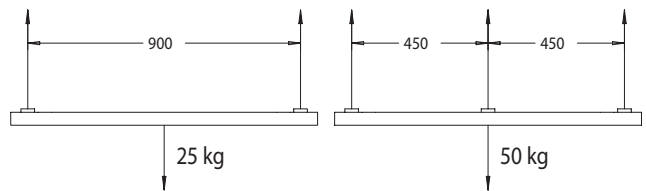

INSTALLATION

There is a polarity on the lighting track to guarantee the right connection of the multiple pieces of the track. Also end-feeds and connection joints have a polarity that must be taken into account in order to choose the right component. In the catalogue sketches of these articles, the position of the polarity is highlighted with a red line.

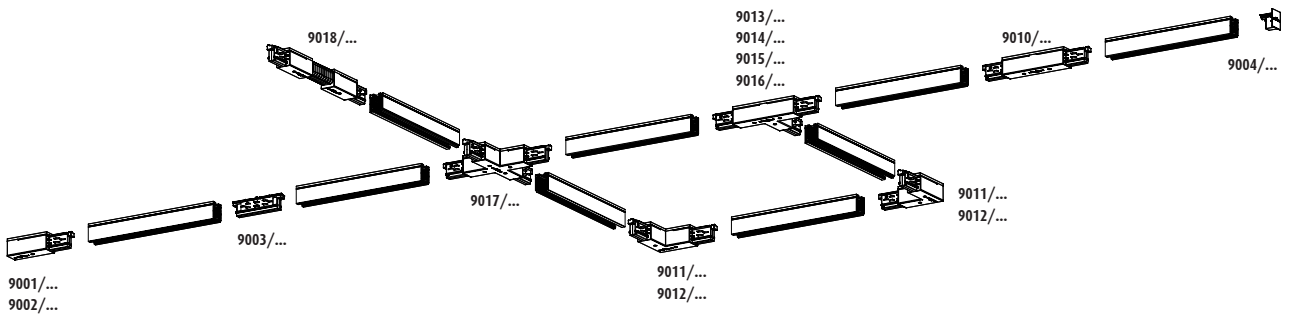

Lateral power supplies

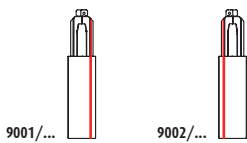

Central power supplies



"L" Joint

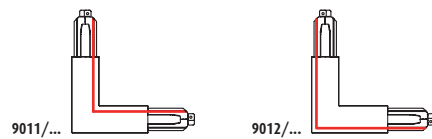

"T" Joint

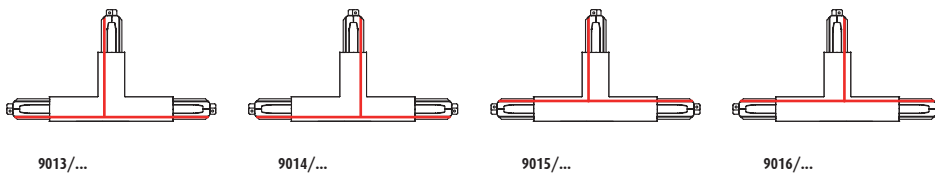

"X" Joint

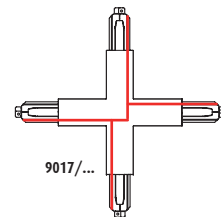

Top view



TL TRACK

3000K and 4000K



Indoor

LED PANELS

LED PANELS - SIDELIGHT



87 BASIC

SLIMFLUX NWB3
+ UGR

NEW



88 BASIC

SLIMFLUX NWB4
+ UGR



89 PRO

SLIMFLUX
IP65



90 PRO

SLIMFLUX MULTI
CURRENT PANEL
ON/OFF



91 PRO

SLIMFLUX DALI
MULTI CURRENT
PANEL

LED PANELS - BACKLIT

NEW



92 PLUS

CEILING-MOUNTED
SLIMFLUX BACKLIT
PANEL

NEW



93 PLUS

SLIMFLUX BACKLIT
PANEL

NEW

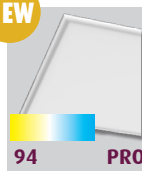

94 PRO

SLIMFLUX BACKLIT
PANEL
UGR CCT

SPECIAL AND DECORATIVE LED PANELS

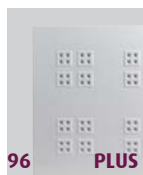

96 PLUS

SLIMFLUX Q4

NEW



98 PLUS-PRO

VINTAGE RECESSED
PANEL + DALI



102

SLIMFLUX
ACCESSORIES



106 PRO

SLIMFLUX PANEL
ROUND 60
DIMMABLE



106 PRO

SLIMFLUX PANEL
UP&DOWN
TRANSLUCENT
DIMMABLE PANEL

PANEL RANGE

SLIMFLUX NWB

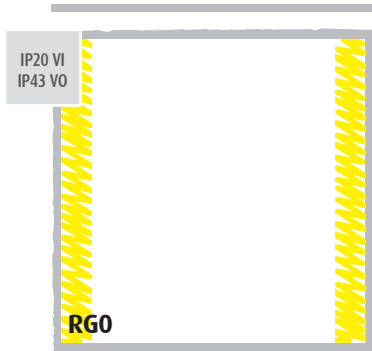

SIDELIGHT
Indirect lighting from both sides of the frame

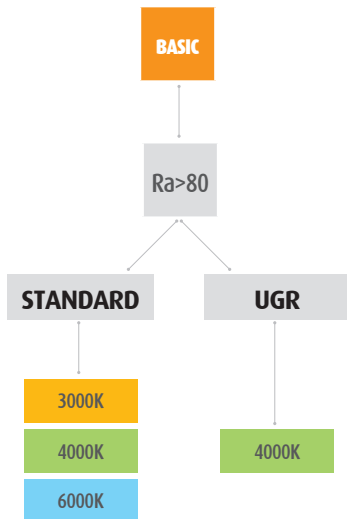

SLIMFLUX IP65

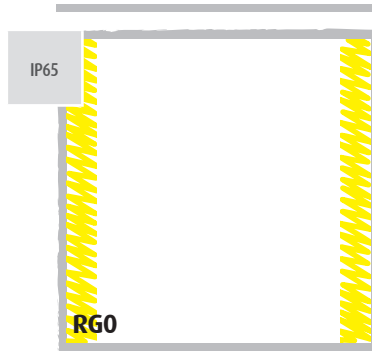

SIDELIGHT
Indirect lighting from both sides of the frame

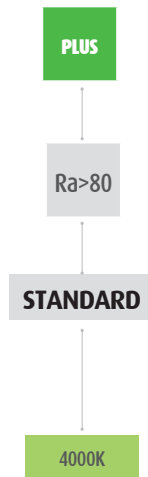

SLIMFLUX MULTI

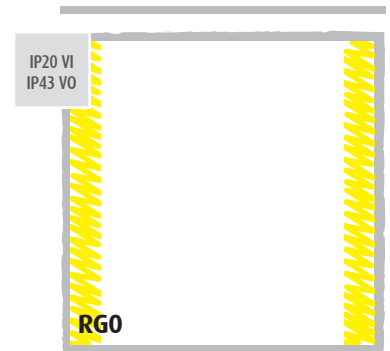

SIDELIGHT
Indirect lighting from both sides of the frame

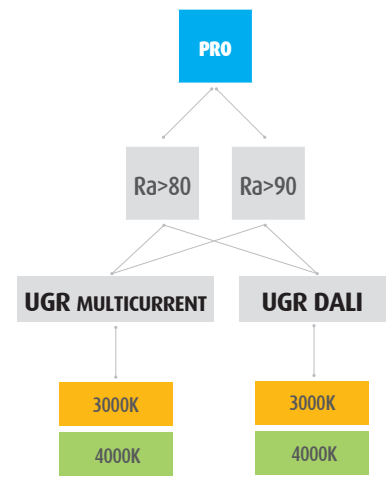

MODEL	MODEL	MODEL
STANDARD/UGR	STANDARD	UGR: MULTICURRENT/DALI
DURATION	DURATION	DURATION
25000H L70 B20	50000H L70 B20	50000H L80 B20
WARRANTY	WARRANTY	WARRANTY
G3	G5 h24	G5 h24
DIFFUSER - LGP*	DIFFUSER - LGP*	DIFFUSER - LGP*
PS anti-yellowing - PS anti-yellowing	PMMA - PMMA	PMMA - PMMA
DRIVER	DRIVER	DRIVER
NWB4: FLICKER FREE NWB3: LOW FLICKER	FLICKER FREE	FLICKER FREE MULTICURRENT + DALI DRIVER ENEC
CHARACTERISTICS AND DIMENSIONS	CHARACTERISTICS AND DIMENSIONS	CHARACTERISTICS AND DIMENSIONS
GAMMA BASE	GORE-TEX® compensation and anti-condensation valve	Anti-fall cable Terminal block for cascade connection

60X60
30X120
60X120

60X60

60X60
62X62
30X120
60X120

SLIMFLUX PLAFO

PLAFONATO

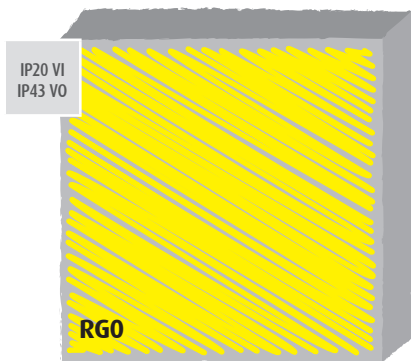

BACKLIT

Direct lighting from a front diffuser

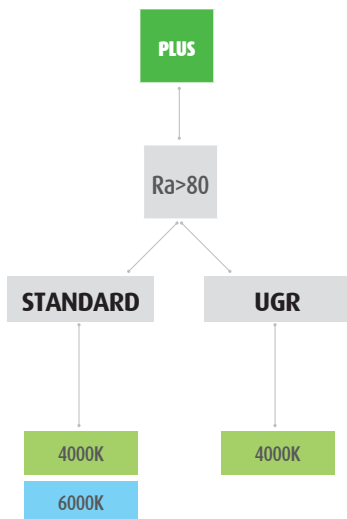

SLIMFLUX B1-B2

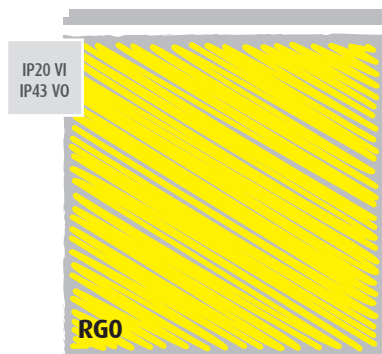

BACKLIT

Direct lighting from a front diffuser

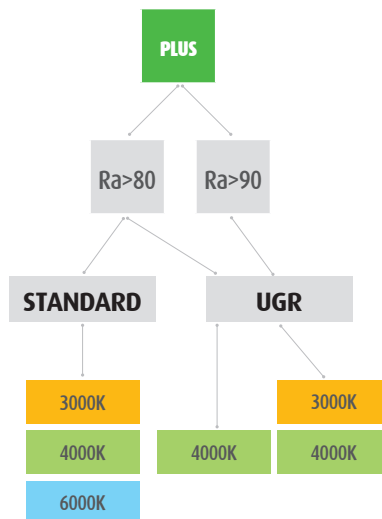

SLIMFLUX CCT

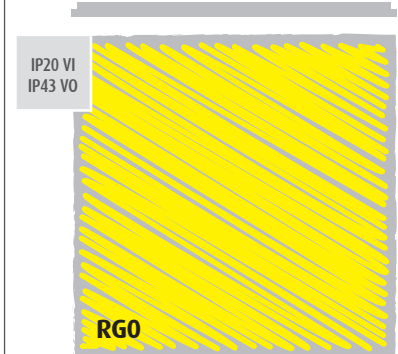

BACKLIT

Direct lighting from a front diffuser

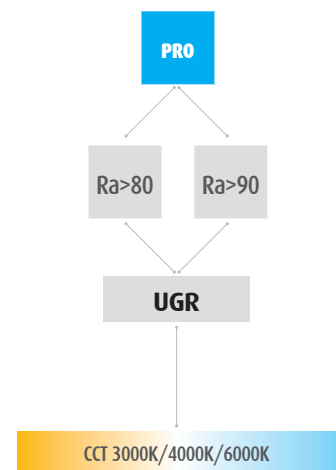

MODEL	MODEL	MODEL
STANDARD/UGR	STANDARD/UGR	UGR
DURATION	DURATION	DURATION
35000H L70 B20	35000H L70 B20	50000H L80 B20
WARRANTY	WARRANTY	WARRANTY
G3	G3	G5 h24
DIFFUSER - LENSES	DIFFUSER - LENSES	DIFFUSER - LENSES
PS anti-yellowing - PMMA	PS anti-yellowing - PMMA	PS anti-yellowing - PMMA
DRIVER	DRIVER	DRIVER
FLICKER FREE	FLICKER FREE	FLICKER FREE

D R

CHARACTERISTICS AND DIMENSIONS

Integrated ceiling mounted
high power version

60X60
30X120
60X120

D R

CHARACTERISTICS AND DIMENSIONS

Low Power version

60X60
30X120
60X120

CHARACTERISTICS AND DIMENSIONS

Change temperature with
an easy switch

60X60
30X120
60X120

NOTE: the graphics of the panels are only examples: in both models Sidelight and Backlit, the light is diffused on the screen in a uniform way.

PROFESSIONAL PANEL RANGE

SLIMFLUX Q4 DIRECTIONAL OPTICS

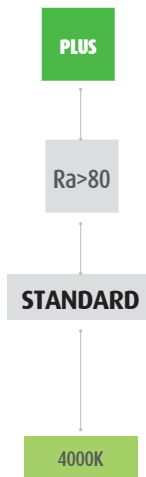
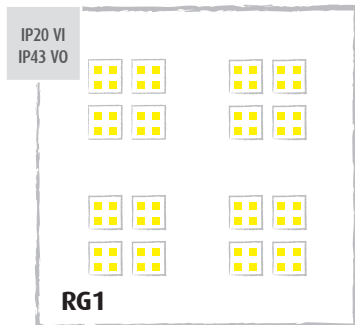

SLIMFLUX VINTAGE

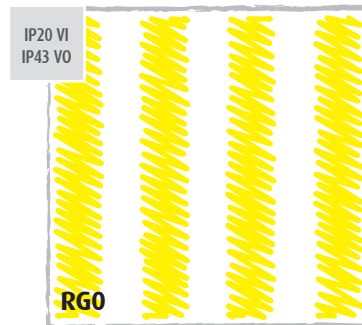

BACKLIT
Direct lighting from a front diffuser

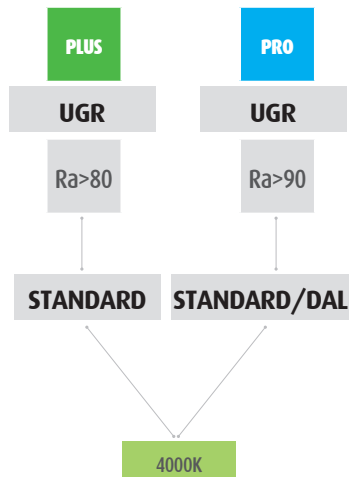

SLIMFLUX ROUND 60

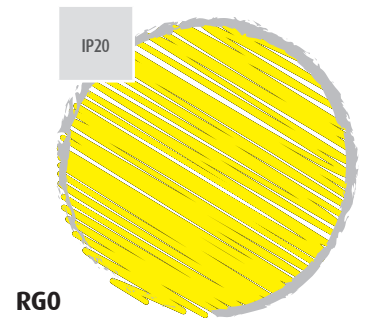

SIDELIGHT
Indirect lighting from the frame

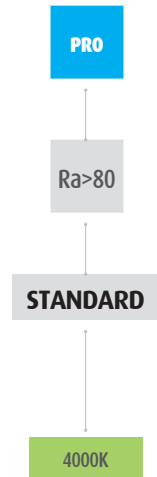

MODEL	MODEL	MODEL
UGR>13!	UGR: STANDARD/DALI	STANDARD/UGR
DURATION	DURATION	DURATION
50000H L70 B20	35000H L70 B20 - 50000H L70 B20	40000H L70
WARRANTY	WARRANTY	WARRANTY
G5 H24	G3 (PLUS) - G5 H24 (PRO)	G3
DIFFUSER - LENSES	DIFFUSER	DIFFUSER - LENSES
- - PMMA	PS anti-yellowing	SCREEN PMMA
DRIVER	DRIVER	DRIVER
Remote	On board	Recessed dimmable Surface mounted dimmable Suspension mounted dimmable
CHARACTERISTICS AND DIMENSIONS	CHARACTERISTICS AND DIMENSIONS	
Directional optics low glare	Dark light appearance	
60X60	60X60 30X120	Ø 60

SLIMFLUX UP&DOWN

UP&DOWN TRANSLUCENT

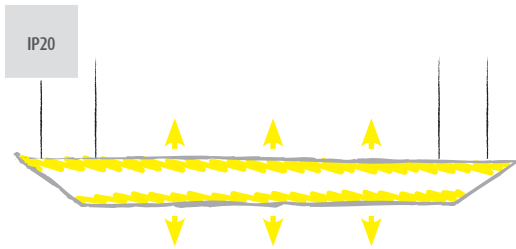

RG0

SIDELIGHT
Indirect lighting from both
sides of the frame

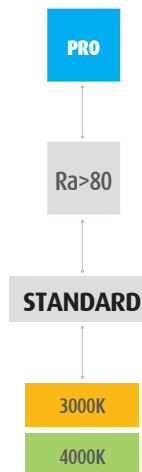

MODEL

TRANSLUCENT

DURATION

30000h I70 B20

WARRANTY

G3

LGP

PMMA

DRIVER

DIMMABLE 1-10V

CHARACTERISTICS AND DIMENSIONS

TRANSLUCENT

30X120

ACCESSORIES

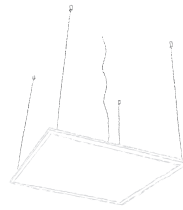

Adjustable steel suspension wires

RG0



Plus model for 120x30 panels
Plus model for 60x60 panels

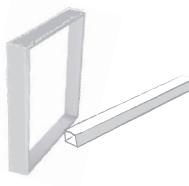

Basic model for 60x60 panels - Assembly Kit
Basic model for 120x30 panels - Assembly Kit



Metal springs kit for recessed installation



Anti-fall safety wire and terminal block



Terminal block

D DIMMABILITY: SLIMFLUX panels can be used with multi-current dimming power supply, code DELT40D-M or DELT65D.M

R STANDBY LIGHTING: SLIMFLUX panels can be used with standby emergency kit, code KTEMRO3.

SLIMFLUX 60X60 BASIC + UGR PANELS

TYPE

Ultra-flat LED fixtures with lateral lighting

CHARACTERISTICS

Side heat dissipation. Immediate switch-on. High colour rendering: Ra>80. Remote power supply included. Do not use with dimmer. If you want to dim or use the multi-current power supply dimmer, see the relevant page of the catalogue. UGR version also available. Class II fittings.

MOUNTING

Possibilities include: recessed, suspended, ceiling/wall. Surface mounting & adjustable suspension wire kits are available as accessories.

MATERIALS

White painted metal body.

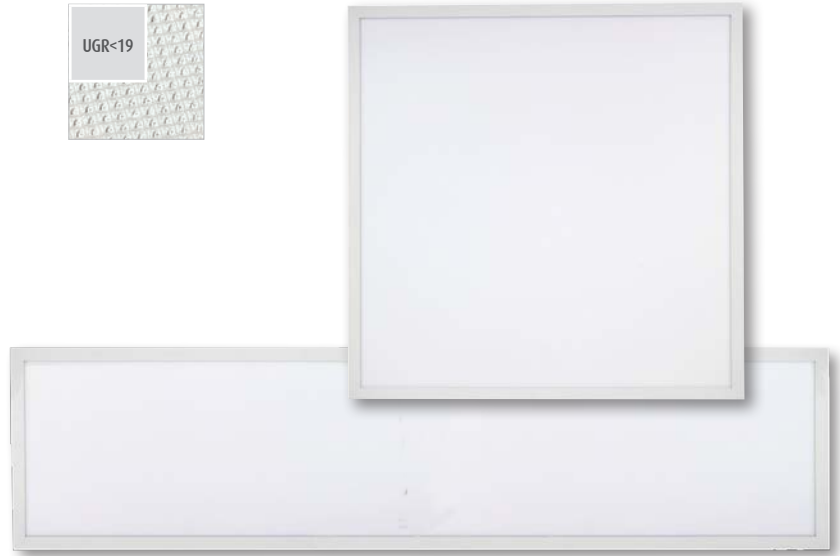

BASIC	220-240V 50/60Hz	Ra>80		25000h L70B20	IP20 VI IP43 VO		-25° +35°C		G3		A++ A+ A	Risk Group 0
art.	W	lm	K	PF	L	L1	L2			8011905		
LP6060WWB3	40	3400	3000	0,9	595	595	10	2300	934415	5		
LP6060NB3	40	3600	4000	0,9	595	595	10	2300	855567	5		
LP6060CWB3	40	3600	6000	0,9	595	595	10	2300	863203	5		
LP30120NB3	40	3400	4000	0,9	1195	295	10	3800	934262	5		

UGR<19	art.	W	lm	K	PF	L	L1	L2			8011905	
LP6060NB3-UGR	40	3400	4000	0,9	595	595	10	2300	862800	5		

DIMMABILITY: SLIMFLUX panels can be used with multi-current dimming power supply, code DELT40D-M.
STANDBY LIGHTING: SLIMFLUX panels can be used with standby emergency kit, code KTEMRO3.

• Minimum Order Quantity

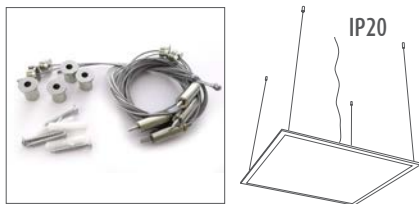

art.	L		80119058	
KTLP-SPU Adjustable suspension wires kit	1500	61193	1	

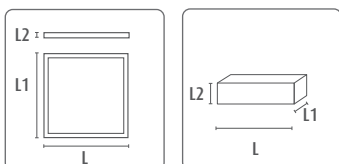

DRIVER:
L= 145 mm
L1= 50 mm
L2= 33 mm

See the accessories page:



EVO SLIMFLUX 60X60 BASIC + UGR PANELS

TYPE

Ultra-flat LED fixtures with lateral lighting

CHARACTERISTICS

Side heat dissipation. Immediate switch-on. High colour rendering: Ra>80. Remote power supply included. Do not use with dimmer. If you want to dim or use the multi-current power supply dimmer, see the relevant page of the catalogue. UGR version also available. Class II fittings.

MOUNTING

Possibilities include: recessed, suspended, ceiling/wall. Surface mounting & adjustable suspension wire kits are available as accessories.

MATERIALS

White painted metal body.



FLICKER FREE

Providing greater visual comfort, improved definition of detail and reduction of stress.

BASIC	220-240V 50/60Hz	Ra>80		25000h L70	IP20 VI IP43 VO		-25° +35°C		G3		A++ A+ A	Risk Group 0
--------------	---------------------	-------	--	---------------	--------------------	--	---------------	--	-----------	--	----------------	-----------------

	art.	W	lm	K	PF	L	L1	L2			
New	LP6060WWB4	40	4000	3000	0,95	595	595	10	1700	8011905	5
New	LP6060NWB4	40	4000	4000	0,95	595	595	10	1700	8011905	5
New	LP6060CWB4	40	4000	6000	0,95	595	595	10	1700	8011905	5

• Minimum Order Quantity



	art.	W	lm	K	PF	L	L1	L2			
New	LP6060NWB4-UGR	40	3600	4000	0,95	595	595	10	2050	8011905	5

• Minimum Order Quantity

DIMMABILITY: SLIMFLUX panels can be used with multi-current dimming power supply, code DELT40D-M.

STANDBY LIGHTING: SLIMFLUX panels can be used with standby emergency kit, code KTEMR03.



art.	L		
KTLP-SPU Adjustable suspension wires kit	1500	80119058	1

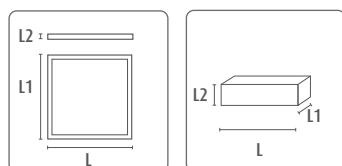

DRIVER:
L= 115 mm
L1= 45 mm
L2= 29,5 mm

See the accessories page:



SLIMFLUX PANEL IP65

TYPE

Very thin LED panel with IP65 protection rating.

CHARACTERISTICS

Panel equipped with a resin coated power supply providing an IP65 connection to both the panel and exposed wiring: May be used in installations that are exposed to particularly difficult environmental conditions without the need for precautions to protect the driver. Panel suitable for outdoor installations and in places such as bathrooms, kitchens, plant areas etc. Equipped with a GORE-TEX® valve to compensate for pressure variations due to thermal changes and to prevent the formation of condensation in the fixture.

MATERIALS

Painted white aluminium body; PMMA screen.

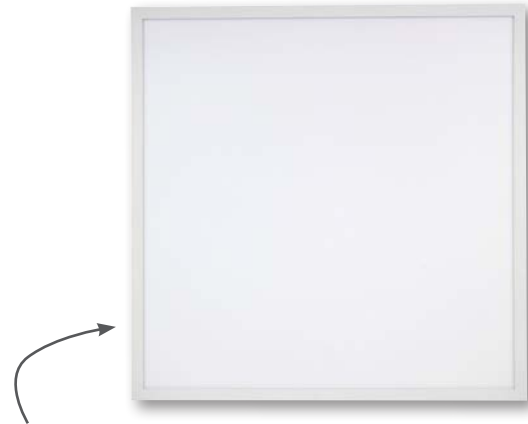

Equipped with a GORE-TEX® valve to compensate for pressure variations

FLICKER FREE

Providing greater visual comfort, improved definition of detail and reduction of stress.

PRO	220-240V 50/60Hz	Ra>80		50000h L70 B20	IP65		-20° +40°C		G5/h24	A++ A+ A	Risk Group 0
------------	---------------------	-------	--	-------------------	------	--	---------------	--	--------	----------------	-----------------

art.	W	lm	K	PF	L	L1	L2			
LP6060NEX	36	3300	4000	0,95	595	595	11,5	4100	8011905	929442 4

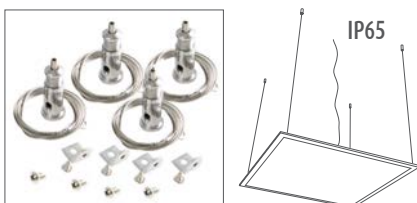

art.	L		
KTLP-SPU Adjustable suspension wires kit	1500	80119058 61193	1

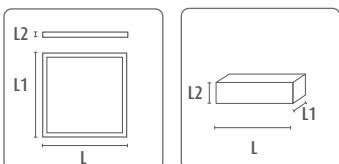

DRIVER:
L= 131,5mm
L1= 44 mm
L2= 30 mm

See the accessories page:



SLIMFLUX PANEL

Version:
Ra>80 or Ra>90



Very thin LED panel with UGR<19 and multi current power supply.

Laterally positioned LED sources: the light spreads from the frame to the screen.

Version:
 - Non-Dimmable
 - DALI Dimmable



DALI PUSH

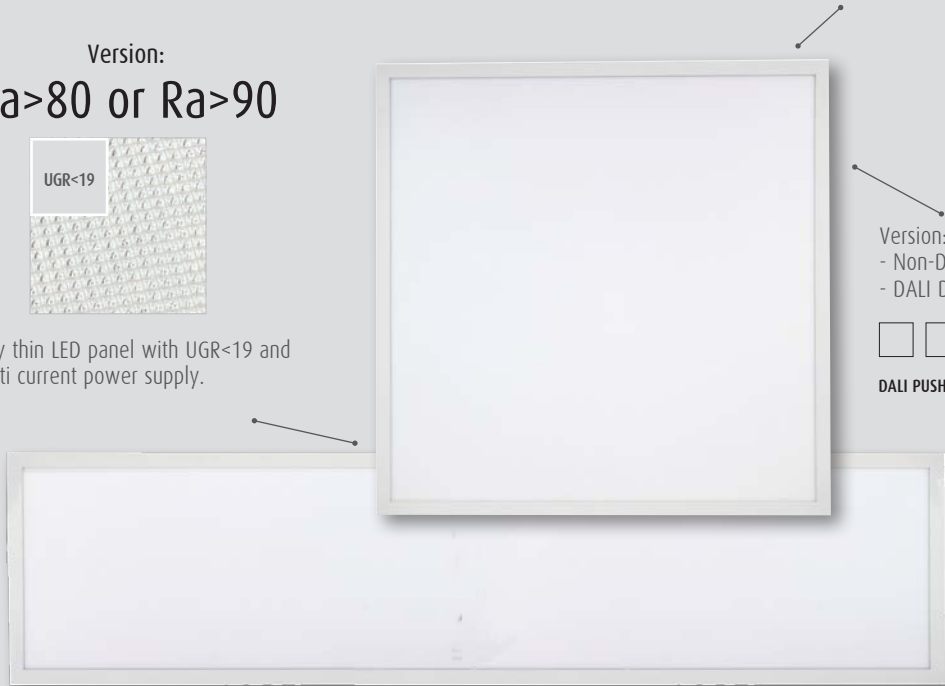

Equipped with a fall arrest system and a terminal board for cascade connections.

High transmittance PMMA optical screen.

FLICKER FREE

for greater visual comfort, stress reduction and better definition of details

REAL LUMENS

Luminous Flux Data is REAL. Values are measured on actual use conditions. Nominal values of the LED source are not stated.

SLIMFLUX MULTI CURRENT PANEL RA>80 AND RA>90 - PRO

TYPE

Very thin LED panel with UGR<19 Lateral lighting, and multi current power supply.

CHARACTERISTICS

The multi current power supply unit makes it possible to choose the drive current of the fixture upon installation depending on the required illumination. This type of panel allows for installation of the same product in different areas to obtain the most suitable amount of light in each space while maximising energy savings. Luminaire is equipped with a fall arrest system and a terminal board for cascade connections. Driver ENEC. Colour rendering >80 and >90.

MATERIALS

Painted white aluminium body; High transmittance PMMA optical screen.



Luminous emission table and total power of the panel according to the setting of the power supply switch.

Total power	Driver SET mA	Ra>80			Ra>90		
		LP6060UGR-830A LP6262UGR-830A	LP6060UGR-840A LP6262UGR-840A	LP30120UGR-840A	LP6060UGR-930A LP6262UGR-930A	LP6060UGR-940A LP6262UGR-940A	LP30120UGR-940A
37W	900mA	4010 lumen	4350 lumen	3920 lumen	3370 lumen	3660 lumen	3300 lumen
34W	850mA	3830 lumen	4160 lumen	3740 lumen	3220 lumen	3500 lumen	3150 lumen
33W	800mA	3640 lumen	3950 lumen	3550 lumen	3060 lumen	3320 lumen	2990 lumen
31W	750mA	3440 lumen	3730 lumen	3360 lumen	2890 lumen	3140 lumen	2830 lumen

PRO	220-240V 50/60Hz		50000h L80 B20	IP20 VI IP43 VO	UGR<19		-20° +45°C		G5/h24	A++ A+ A	Risk Group 0
------------	---------------------	--	-------------------	--------------------	--------	--	---------------	--	--------	----------------	-----------------

Ra>80											
art.	W	lm	K	PF	L	L1	L2			8011905	
LP6060UGR-830A	31/37	3440/4010	3000	0,95	595	595	9	2200		931810	5
LP6060UGR-840A	31/37	3730/4350	4000	0,95	595	595	9	2200		931735	5
LP6262UGR-830A *	31/37	3440/4010	3000	0,95	620	620	9	2700	- -	- -	5
LP6262UGR-840A	31/37	3730/4350	4000	0,95	620	620	9	2700		933302	5
LP30120UGR-840A *	31/37	3360/3920	4000	0,95	295	1195	9	3800		931896	5
Ra>90											
art.	W	lm	K	PF	L	L1	L2			8011905	
LP6060UGR-930A	31/37	2890/3370	3000	0,95	595	595	9	2200		931858	5
LP6060UGR-940A	31/37	3140/3660	4000	0,95	595	595	9	2200		931773	5
LP6262UGR-930A *	31/37	2890/3370	3000	0,95	620	620	9	2700	- -	- -	5
LP6262UGR-940A *	31/37	3140/3660	4000	0,95	620	620	9	2700	- -	- -	5
LP30120UGR-940A	31/37	2830/3300	4000	0,95	295	1195	9	3800		933272	5

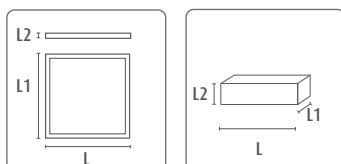

* Subject to minimum order.

DRIVER:
L= 97 mm
L1= 44 mm
L2= 30 mm

STANDBY LIGHTING: SLIMFLUX panels can be used with standby emergency kit, code KTEMR03.

SLIMFLUX DALI MULTI CURRENT PANEL RA>80 AND RA>90 - PRO

Luminous emission table and total power of the panel according to the setting of the power supply switch.

DALI		Ra>80			Ra>90		
Total power		LP6060UGR-830D LP6262UGR-830D	LP6060UGR-840D LP6262UGR-840D	LP30120UGR-840D	LP6060UGR-930D LP6262UGR-930D	LP6060UGR-940D LP6262UGR-940D	LP30120UGR-940D
37W	900mA	4010 lumen	4350 lumen	3920 lumen	3370 lumen	3660 lumen	3300 lumen
34W	850mA	3830 lumen	4160 lumen	3740 lumen	3220 lumen	3500 lumen	3150 lumen
33W	800mA	3640 lumen	3950 lumen	3550 lumen	3060 lumen	3320 lumen	2990 lumen
31W	750mA	3440 lumen	3730 lumen	3360 lumen	2890 lumen	3140 lumen	2830 lumen
29W	700mA	3210 lumen	3480 lumen	3130 lumen	2700 lumen	2930 lumen	2640 lumen
24W	600mA	2760 lumen	2990 lumen	2690 lumen	2320 lumen	2520 lumen	2270 lumen

PRO 220-240V 50/60Hz 50000h L80 B20 UGR<19 -20° +45°C **A++** **A+** **A** Risk Group 0

Ra>80

art.	W	lm	K	PF	L	L1	L2		8011905	
LP6060UGR-830D	24/37	2760/4010	3000	0,95	595	595	9	2200	931841	5
LP6060UGR-840D	24/37	2990/4350	4000	0,95	595	595	9	2200	931766	5
LP6262UGR-830D *	24/37	2760/4010	3000	0,95	620	620	9	2700	--	5
LP6262UGR-840D	24/37	3730/4350	4000	0,95	620	620	9	2700	933296	5
LP30120UGR-840D *	24/37	2690/3920	4000	0,95	295	1195	9	3800	931926	5

Ra>90

art.	W	lm	K	PF	L	L1	L2		8011905	
LP6060UGR-930D	24/37	2320/3370	3000	0,95	595	595	9	2200	931889	5
LP6060UGR-940D	24/37	2520/3660	4000	0,95	595	595	9	2200	931803	5
LP6262UGR-930D *	24/37	2320/3370	3000	0,95	620	620	9	2400	--	5
LP6262UGR-940D *	24/37	2520/3660	4000	0,95	620	620	9	2400	--	5
LP30120UGR-940D	24/37	2270/3300	4000	0,95	295	1195	9	2400	933258	5

* Subject to minimum order.

STANDBY LIGHTING: SLIMFLUX panels can be used with standby emergency kit, code KTEMRO3.

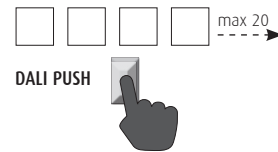

SLIMFLUX ACCESSORY

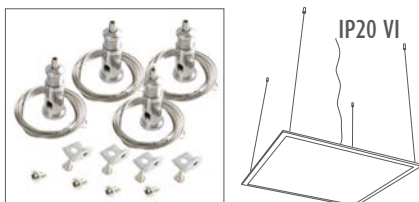

art.	L	80119058	
KTLP-SPU Adjustable suspension wires kit	1500	61193	1

See the accessories page:



CEILING-MOUNTED SLIMFLUX BACKLIT PANEL RA>80

TYPE

LED panel or direct lighting complete with a ceiling-mounted frame for surface installation. Also available in a UGR version.

CHARACTERISTICS

Fixtures can be also be surface mounted both vertically and horizontally. The positioning of the LED sources on a horizontal plate ensures lighting uniformity on the screen surface and excellent efficiency levels. If a dimmable version is needed, please use the multi-current dimming power supply
Colour rendering >80.

MATERIALS

White painted aluminium body; high transmittance optical PMMA screen.



FLICKER FREE III

Providing greater visual comfort, improved definition of detail and reduction of stress.

PLUS	220-240V 50/60Hz	Ra>80		35000h L70 B20	IP20 VI IP43 VO		-25° +35°C		G3		Risk Group 0
-------------	---------------------	-------	--	-------------------	--------------------	--	---------------	--	-----------	--	-----------------

	art.	W	lm	K	PF	L	L1	L2			
New	LP6060P1-840	40	4000	4000	0,95	600	600	40	2000		5
New	LP6060P2-860	60	6000	6000	0,95	600	600	40	2100		5
New	LP30120P1-840	40	4000	4000	0,95	300	1200	40	2400		5
New	LP60120P1-840	60	6000	4000	0,95	600	1200	40	4500		5

• Minimum Order Quantity



	art.	W	lm	K	PF	L	L1	L2			
New	LP6060P1UGR-840	40	4000	4000	0,95	600	600	40	2300		5

• Minimum Order Quantity

DIMMABILITY: SLIMFLUX panels can be used with multi-current dimming power supply, code DELT40D-M.
STANDBY LIGHTING: SLIMFLUX panels can be used with standby emergency kit, code KTEMR03.

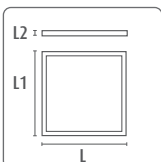

SLIMFLUX BACKLIT PANEL + UGR

TYPE

Direct lighting LED panel.

CHARACTERISTICS

Remote power supply equipped with a dip-switch to select the colour temperature. The backlit panel is composed of a metal material back compartment providing a heat sink function. The LED sources positioned on a horizontal plate ensure lighting uniformity on the diffuser surface and ensure excellent efficiency levels. >80

MOUNTING

Consider more depth for recessed installations.

MATERIALS

Painted white aluminium body; anti-yellowing PS screen.

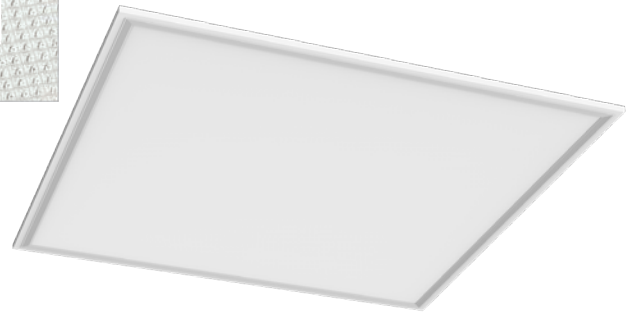

Direct lighting

FLICKER FREE

Providing greater visual comfort, improved definition of detail and reduction of stress.

PLUS	220-240V 50/60Hz	Ra>80		35000h L70 B20	IP20 VI IP43 VO		-25° +40°C		G3		A++ A+ A	Risk Group 0
-------------	---------------------	-------	--	-------------------	--------------------	--	---------------	--	-----------	--	----------------	-----------------

	art.	W	lm	K	PF	L	L1	L2			
New	LP6060B1-830	40	4000	3000	0,9	595	595	30	1700	951160	6
New	LP6060B1-840	40	4000	4000	0,9	595	595	30	1700	951177	6
New	LP6060B1-860	40	4000	6000	0,9	595	595	30	1700	951184	6
New	LP6060B2-840	32	3200	4000	0,9	595	595	30	1700	951191	6
New	LP30120B1-840	40	4000	4000	0,9	295	1195	30	1800	951207	6
New	LP60120B1-840	50	5000	4000	0,9	595	1195	30	4150	951214	4

• Minimum Order Quantity

UGR<19	Ra>80
--------	-------

	art.	W	lm	K	PF	L	L1	L2			
New	LP6060B1UGR-840	40	4000	4000	0,9	595	595	30	2050	951153	6

• Minimum Order Quantity

UGR<19	Ra>90
--------	-------

	art.	W	lm	K	PF	L	L1	L2			
New	LP6060B1UGR-930	40	4000	3000	0,9	595	595	30	2050	959944	6
New	LP6060B1UGR-940	40	4000	4000	0,9	595	595	30	2050	959531	6

• Minimum Order Quantity

DIMMABILITY: SLIMFLUX panels can be used with multi-current dimming power supply, code DELT40D-M.

STANDBY LIGHTING: SLIMFLUX panels can be used with standby emergency kit, code KTEMR03.

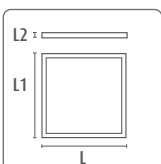

See the accessories page:



CEILING-MOUNTED SLIMFLUX BACKLIT PANEL

TYPE

LED panel for direct lighting. Luminaire with facility to select the colour temperature on installation.

CHARACTERISTICS

Remote power supply equipped with a dip-switch to select the colour temperature. The backlit panel is composed of a metal material back compartment providing a heat sink function. The LED sources positioned on a horizontal plate ensure lighting uniformity on the diffuser surface and ensure excellent efficiency levels. >80 or Ra>90 colour rendering. Flicker free.

MOUNTING

Consider more depth for recessed installations.

MATERIALS

Painted white aluminium body; anti-yellowing PS screen.

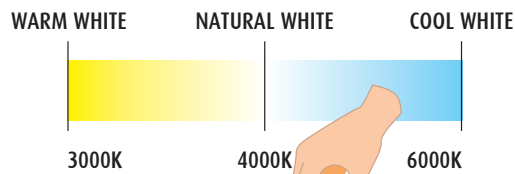
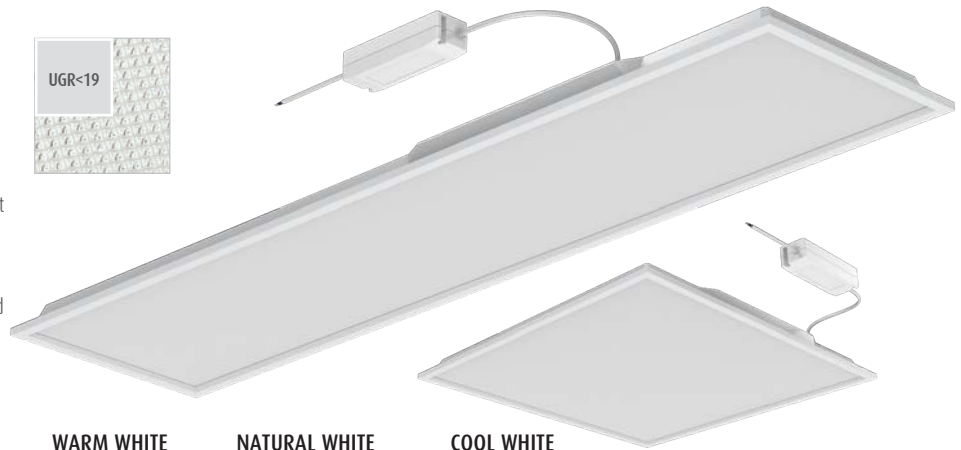
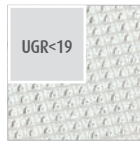

SWITCH

FLICKER FREE

Providing greater visual comfort, improved definition of detail and reduction of stress.

PRO	220-240V 50/60Hz		50000h L80 B20	IP20 VI IP43 VO		-25° +40°C		G5/h24	A++ A+ A	Risk Group 0
------------	---------------------	--	-------------------	--------------------	--	---------------	--	--------	----------------	-----------------

Ra>80

art.	W	lm	K	PF	L	L1	L2			
New LP6060B1UGR-8CCT	38	4500*	3000/4000/6000	0,95	595	595	40	2230	8011905	4
New LP6060B2UGR-8CCT	47	5500*	3000/4000/6000	0,95	595	1195	40	2230	951351	4

* Lumen and power data are referred to 4000K colour temperature.

• Minimum Order Quantity

Ra>90

art.	W	lm	K	PF	L	L1	L2			
New LP6060B1UGR-9CCT	38	4000*	3000/4000/6000	0,95	595	595	40	2230	8011905	4
New LP30120B1UGR-9CCT	38	4000*	3000/4000/6000	0,95	295	1195	40	2950	951337	4
New LP60120B1UGR-9CCT	50	5200*	3000/4000/6000	0,95	595	1195	40	3960	951344	4

* Lumen and power data are referred to 4000K colour temperature.

• Minimum Order Quantity

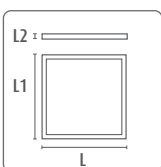

See the accessories page:

Surface mounting LPLAF060
LPLAF030120





SLIMFLUX PANEL

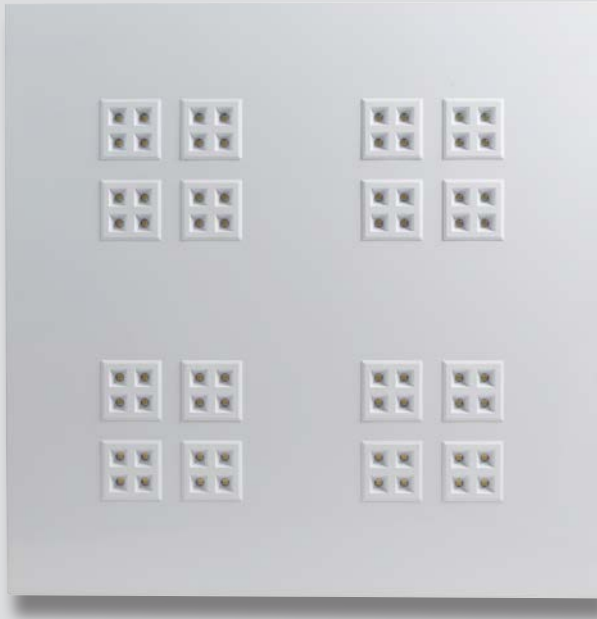

The peculiar shape of each reflector, together with the set back source positioning, allow for precise control of the light emission and the reduction of glare, obtaining $UGR < 13$.

SLIMFLUX 60x60 Q4: mounting with the KTLQ4-SP accessory.



Thickness only 15 mm

For the photometrics see the special section or consult the web site.



SLIMFLUX PANEL 60X60 Q4

TYPE

LED panel with dedicated micro modular optics for better beam control.

CHARACTERISTICS

The primary lens, coupled with a special reflector dedicated to managing every LED beam allows for precise light distribution and total glare control, ensuring UGR<13.

MATERIALS

White painted metal body.

NB

Remote driver included.



PLUS	220-240V 50/60Hz	Ra>80		50000h L70 B20	IP20 VI IP43 VO	UGR<13		-25° +35°C		G5/h24		A++ A+ A	Risk Group 1
art.	W	lm	K	PF	cd		L	L1	L2			80119058	
LP6060NWQ4	35	4500	4000	0,9	5000	60°	595	595	23	3000	61957		5

DIMMABILITY: SLIMFLUX panels can be used with multi-current dimming power supply, code DELT40D-M.
STANDBY LIGHTING: SLIMFLUX panels can be used with standby emergency kit, code KTEMR03.

SLIMFLUX 60X60 Q4 ACCESSORIES

TYPE

SLIMFLUX 60X60 Q4 LED panels accessories for recessed, surface or suspension installation.



art	L	L1			
KTLPQ4-MS	55	26	10396	1	
Metal springs kit for recessed installation - 4 pieces					
art	L				
KTLPQ4-SP	1500	10402	1		
Cables kit for suspension installation					
art	L	L1	L2		
KTLPQ4-SM	565	565	14,6	10419	1
Surface installation kit					

See the accessories page:

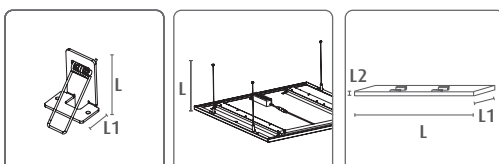

DRIVER:
L= 135 cm
L1= 36 cm
L2= 26 cm

VINTAGE RECESSED PANEL



UGR<19

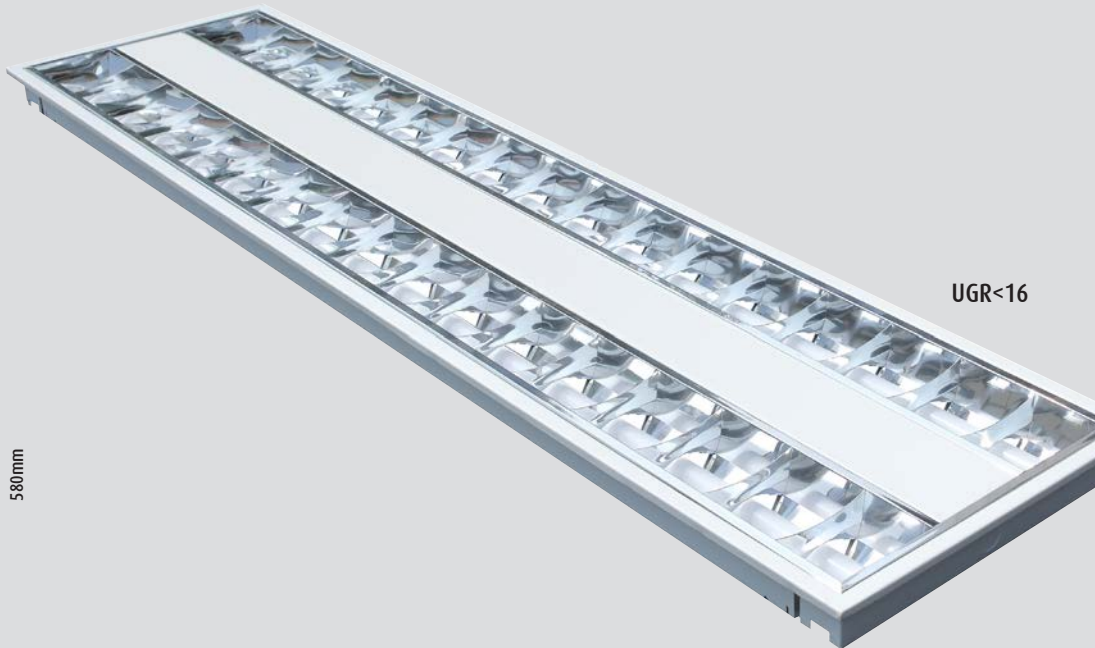

UGR<16

38W
580mm
580mm

33W
1180mm
280mm

For the photometrics see the special section or consult the web site.



For ceiling installation see the accessory page

APPLICATIONS

Offices, laboratories, school environments, surgeries...



OPTICS DETAIL

VINTAGE RECESSED PANEL

TYPE

Recessed panel 'vintage' style, with integrated non replaceable high efficiency LED source.

CHARACTERISTICS

'Vintage' recessed panel ideal to maintain existing aesthetics and provide significant energy savings and lower maintenance costs.

60x60= UGR<19

30x120= UGR<16

MATERIALS

Steel body treated with UV resistant polymers; anti-glare louvre high reflectancy aluminized polycarbonate with 83% efficacy.

POWER SUPPLY

Integrated power supply. Integrated light source not replaceable.

PLUS	220-240V 50/60Hz	Ra>80		25000h L70 B20	IP20 VI IP40 VO	UGR<16 UGR<19		-25° +35°C		G3	A++ A+ A	Risk Group 0
-------------	---------------------	-------	--	-------------------	--------------------	------------------	--	---------------	--	-----------	----------------	-----------------

art.	W	lm	K	PF	cd		L1	L2	L3			
PV6060NW	38	3900	4000	0,9	2330	100°x80°	595	595	43	3500	80119058	5
PV30120NW	33	4300	4000	0,9	2330	100°x80°	1195	295	43	3700	55871	5

PRO	220-240V 50/60Hz	50000h L70 B20	IP20 VI IP40 VO	UGR<16 UGR<19		-25° +35°C		G5/h24	A++ A+ A	Risk Group 0
------------	---------------------	-------------------	--------------------	------------------	--	---------------	--	---------------	----------------	-----------------

Ra>90	
-------	--

	art.	W	lm	K	PF	cd		L1	L2	L3			
New	PV6060UGR-940	38	3750	4000	0,9	2240	100°x80°	595	595	43	3500	951368	5
New	PV30120UGR-940	33	4100	4000	0,9	2240	100°x80°	1195	295	43	3700	951375	5

Ra>90	
-------	--

	art.	W	lm	K	PF	cd		L1	L2	L3			
New	PV6060UGR-940D	38	3750	4000	0,9	2240	100°x80°	595	595	43	3500	955540	5
New	PV30120UGR-940D	33	4100	4000	0,9	2240	100°x80°	1195	295	43	3700	955434	5

• Minimum Order Quantity

See the accessories page:

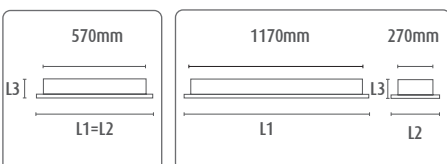





SLIMFLUX

Surface mounting with
LPLAF060 frame

SLIMFLUX ACCESSORY

TYPE

Frames for mounting LED panels on ceilings.

CHARACTERISTICS

Make it possible to use SLIMFLUX panels in ceilings where there is no possibility to install recessed panels; frames can hide the drivers.

MATERIALS

LPLAF01203: painted sheet metal; LPLAF0603 epoxy painted extruded aluminium.

NB

The LPLAF060 and LPLAF0120 models are installed using surface fixing brackets; the LPLAF06030 and LPLAF01203 models the frame fixes directly to the surface. Screws and plugs supplied.



Slimflux 60x60: surface mounting with the frame.



art		L	L1	L2	80119058	
LPLAF060	Fully assembled plus model for 60x60 panels	603	603	60	35637	1
art		L	L1	L2	80119058	
LPLAF0120	Fully assembled plus model for 120x30 panels	1203	303	60	35644	1



art		L	L1	L2	80119058	
LPLAF0603	Self assembly kit Basic model for 60x60 panels	600	600	50	44783	25
art		L	L1	L2	80119058	
LPLAF01203	Self assembly kit Basic model for 120x30 panels	1200	300	50	56045	20

SLIMFLUX ACCESSORY

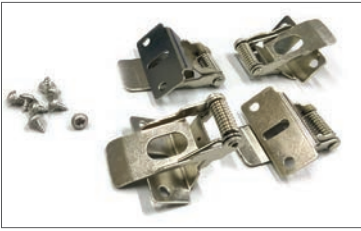

art



KTLPW1-MS Metal springs kit for recessed installation - 4 pieces

923471

1



art

L



LP-SSK Anti-fall safety wire and terminal block

1200

54768

1



art

L



FASTCON-30 Terminal block with 27cm wire

270

54775

1

TONDO 60

4000K





Showroom 107
Moscow

SLIMFLUX PANELS



PROJECT

Suspension version with translucent panel and direct/indirect lighting



SUSPENSION

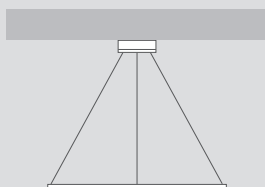

RECESSED MOUNTING



CEILING MOUNTING

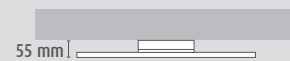

ROUND 60 - DIMMABLE

TYPE

Slim LED panel.

CHARACTERISTICS

SLIMFLUX ROUND 60 installation possibilities: with recessed driver or surface mounting (the panel remains 43 mm away from the mounting surface).

SLIMFLUX ROUND 60 SUSPENSION: pre-wired with ceiling cup to be mounted to the ceiling (driver included) and 85 cm long adjustable suspensions wires.

MATERIALS

White painted metal body; frontal methacrylate panel.

NB

'On Project' suspended version with translucent panel and direct/indirect lighting.

220-240V 50/60Hz	Ra>80		40000h L70	IP20	-25° +35°C		G3	
---------------------	-------	--	---------------	------	---------------	--	----	--

USAGE INFORMATION

Can be used with TRIAC dimmers.



art.	W	lm	K	PF	Ø	L	L1			
LP60TWW	35	3000	3000	0,9	600	12	55	6000	80119058 50654	2
LP60TNW	35	3000	4000	0,9	600	12	55	6000	80119058 50661	2

Recessed or surface mounted fixtures.



art.	W	lm	K	PF	Ø	L	L1			
LP60TSPWW	35	3000	3000	0,9	600	12	850	6000	80119058 50678	2
LP60TSPNW	35	3000	4000	0,9	600	12	850	6000	80119058 50685	2

Suspension fixtures.



Suspension version with translucent panel and direct/indirect lighting

art.	W	lm	K	PF	Ø	L	L1			
LP60TSPDEWW*	36	3300	3000	0,9	580	12	850	3400	80119058 61094	2
LP60TSPDENW*	36	3300	4000	0,9	580	12	850	3400	80119058 61087	2

Suspension fixtures.

*Contact the sales force for MOQ and delivery times.

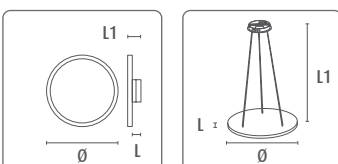

For the photometrics see the special section or consult the web site.

SLIMFLUX PANEL



Light is diffused from the fine white frame to the methacrylate panel. Fractioned by micro incisions on the panel light is directed predominantly downwards. 30% of the light is projected upwards to create a striking effect that adds to any classic or modern environment.



UP&DOWN TRANSLUCENT DIMMABLE PANEL

TYPE

Double emission translucent LED panel.

CHARACTERISTICS

Fixture with visual interest characterised by dual emission - downwards and upwards - along with the translucency of the panel itself.

MATERIALS

White frame with methacrylate panel.

POWER SUPPLY

Remote power supply hidden in a white metal painted gallery housing to be attached to the ceiling.

NB

Complete with a remote driver and adjustable suspension wires (L = 130cm). Cables attached with a safety carabiner.



DIMMABILITY

Can be used with 1-10V dimmers

PRO	220-240V 50/60Hz	Ra>80		30000h L70	IP40		-25° +35°C		G3		Risk Group 0
------------	---------------------	-------	--	---------------	------	--	---------------	--	-----------	--	-----------------

art.	W	lm	K	PF	L	L1	L2			
LP30120DEW-TR	40	4000	3000	0,95	300	1200	9	3900	80119058	5
LP30120DE-TR	40	4000	4000	0,95	300	1200	9	3900	50821	5

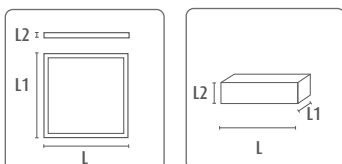

DRIVER:
L= 60 mm
L1= 5,5 mm
L2= 4 mm

For the photometrics see the special section or consult the web site.



Indoor

SURFACE MOUNTED FIXTURES

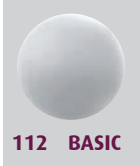

PLAFO T2



FILINO T5

PLAFO T2

TYPE

LED lamps with SMD technology in a fixture for ceiling or surface installations. Version with proximity sensor.

CHARACTERISTICS

Excellent light diffusion across the entire surface. Non-replaceable internal power supply.

MATERIALS

Metal body; satin effect plastic diffusor.

APPLICATIONS

Typically used in stairwells, apartment and residential building entrances, waiting rooms and surgeries, etc.

NB

Do not use with dimmers. Connection to the mains with terminal block.



Version with proximity sensor: ideal where increased visibility and safety is required obtaining the certainty of energy saving.

The sensor is housed inside a cover and is therefore invisible.



BASIC	220-240V 50/60Hz	Ra>80		20000h L70 B30	IP40	-25° +35°C		G3		Risk Group 0
--------------	---------------------	-------	--	-------------------	------	---------------	--	----	--	-----------------

art.	W	lm	cd	K	PF		Ø	L			
LC001W	20	1650	370	3000	0,7	120°	280	90	350	80119058	62688 10
LC001	20	1700	400	4000	0,7	120°	280	90	350	61162	10
LC002W	30	2550	570	3000	0,97	120°	400	120	750	62695	5
LC002	30	2600	600	4000	0,97	120°	400	120	750	61179	5

art.	W	lm	cd	K	PF		Ø	L			
LC001-MW*	20	1600	400	4000	0,70	120°	270	90	290	8011905	927349 10

* Fixture fitted with a proximity sensor.

• Minimum Order Quantity

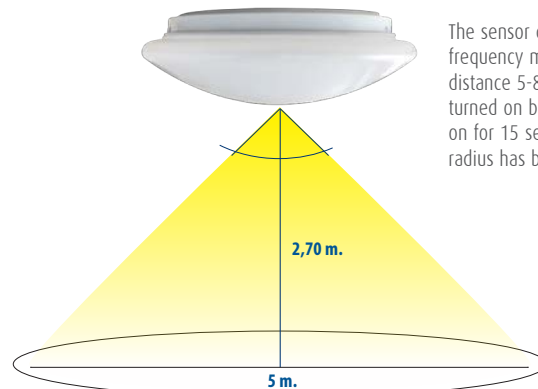
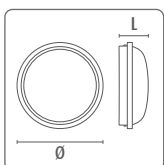

The sensor detects movement by using frequency modulation waves; detection distance 5-8 metres. The fixture is turned on by the sensor and stays on for 15 seconds once the detection radius has been cleared.



PLAFO T2
4000K

FILINO T5



30 CM

NEW SIZE AND COLOURS

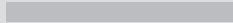

60 CM

NEW COLOURS

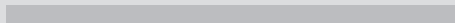

90 CM

NEW SIZE AND COLOURS

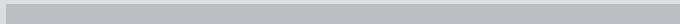

120 CM

NEW COLOURS

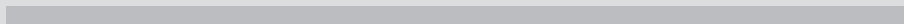

150 CM

NEW SIZE AND COLOURS

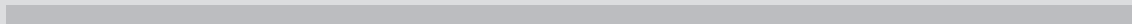

APPLICATIONS

Shelving lights for stores, and under and over cabinets etc.



ANGULAR CONNECTIONS



INSTALLATIONS IN
CONTINUOUS LINES



LIGHT CONTINUITY WITHOUT INTERRUPTIONS

FILINO T5

TYPE

LED T5 replacement professional undercabinet/ceiling batten light.

CHARACTERISTICS

It attaches to both walls and ceilings using the clip included. Filino T5 batten can be installed in series code KTLRT, up to a maximum of 10 units (20W/23W); 15 units (10W/14W); 20 units 4W. Exceptional light quality & easy fixing with the clips provided. On/off switch on the batten body; Free-wire connection: use the accessory cable with a separate code if a plug is required. Filino T5 batten can be installed in series by joining together the units or using the accessory connection cable, code KTLRT.

MATERIALS

Shockproof plastic body and screen; anti-glare milky white screen. Package complete with free wires, connection, 4.



BASIC	220-240V 50/60Hz	Ra>80		20000h L70 B30	IP20	-25° +35°C		G2		A++ A+ A	Risk Group 0
--------------	---------------------	-------	--	-------------------	------	---------------	--	-----------	--	-------------------------------------	-----------------

art.	W	lm	cd	K		L	L1	L2			8011905	
LRT530WW	4	300	55	3000	270°	24	39	300	100		936709	10
LRT530NW	4	350	64	4000	270°	24	39	300	100		936716	10
LRT530CW	4	400	74	6000	270°	24	39	300	100		936723	10
LRT560WW	10	850	157	3000	270°	24	39	600	134		910518	10
LRT560NW	10	900	167	4000	270°	24	39	600	134		861100	10
LRT560CW	10	950	186	6000	270°	24	39	600	134		910495	10
LRT590WW	14	1210	223	3000	270°	24	39	900	200		936730	10
LRT590NW	14	1260	232	4000	270°	24	39	900	200		936747	10
LRT590CW	14	1310	241	6000	270°	24	39	900	200		936754	10
LRT5120WW	20	1850	325	3000	270°	24	39	1200	235		910471	10
LRT5120NW	20	1900	335	4000	270°	24	39	1200	235		861117	10
LRT5120CW	20	1950	353	6000	270°	24	39	1200	235		910457	10
LRT5150WW	23	2050	260	3000	270°	24	39	1500	250		936761	10
LRT5150NW	23	2100	369	4000	270°	24	39	1500	250		936778	10
LRT5150CW	23	2150	378	6000	270°	24	39	1500	250		936785	10

• Minimum Order Quantity



Connection wire 15.6 cm

art	L	L2		8011905	
KTLRT	19	15,6		861124	1



Connection for Reglette Filino T5

art	L2		8011905	
New KTLRT-CORD	2000		939946	1

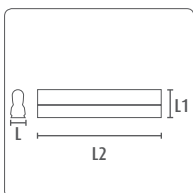



Industrial

BATTEN

NEW



118 PRO

BATTEN BT3
IP65

Preview



120

WATERTIGHT S1
LED
IP65

Preview



122

WATERTIGHT S2
IP65

BATTEN BT3



Designed for environments where diffused lighting and elevated visual comfort are required.

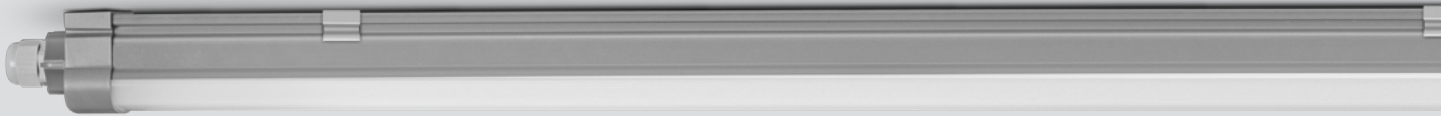

Impact resistant extruded polycarbonate

IP65 rapid connection

Can be used in series of up to 12 fixtures for the 40W model and up to 9 fixtures for the 50W model.

BATTEN BT3

TYPE

Linear ceiling fixture equipped with high efficiency LED sources. Fitted with a quick spring clamp for connection in series.

CHARACTERISTICS

Quick opening mechanism for wiring. Easy to connect in series thanks to the quick spring clamp supplied. Can be used in series of up to 12 fixtures for the 40W model and up to 9 fixtures for the 50W model.

MATERIALS

Polycarbonate body: opal polycarbonate screen equipped with internal fins for flow recovery and emission optimisation.

ASSEMBLY

AISI 316 stainless steel 'snap on' bracket to anchor to the ceiling or to be used to suspend the fixture. Every package is equipped with both brackets and suspension cables (L= 96 cm).

APPLICATIONS

Supermarkets, car parks, laboratories, warehouses.etc.



PRO	220-240V 50/60Hz	Ra>80		50000h L70 B20	IP65	IK08		G5/h24		Risk Group 1
------------	---------------------	-------	--	-------------------	------	------	--	--------	--	-----------------

art.	W	lm	K	PF		L	L1	L2			
New BT103W	40	4160	3000	0,9	120°	63	63	1200	850		10
New BT103N	40	4400	4000	0,9	120°	63	63	1200	850	941116	10
New BT103C	40	4560	6000	0,9	120°	63	63	1200	850	941123	10
New BT104W	50	5200	3000	0,9	120°	63	63	1500	1100	941161	10
New BT104N	50	5500	4000	0,9	120°	63	63	1500	1100	941147	10
New BT104C	50	5700	6000	0,9	120°	63	63	1500	1100	941154	10



art.	L		
KT-BT1-FS Adjustable suspension wires kit	100	927653	1

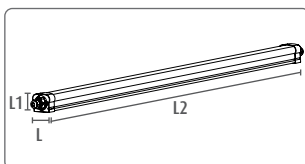

WATERTIGHT S1 IP65

Watertight fixture complete with high efficiency LED lighting



WATERTIGHT S1 IP65

TYPE

Linear TRI-PROOF LED luminaire for surface or suspended installations.

CHARACTERISTICS

Version with integrated high efficiency LED sources.
AISI 316 stainless steel hinges. Quick opening mechanism for cabling. Can be easily connected in series thanks to the quick contact terminals.

MATERIALS

Polycarbonate body; polycarbonate screen with internal photoetching for better light diffusion.

ASSEMBLY

'Snap on' AISI 316 stainless steel brackets for ceiling or suspension installation.
Adjustable suspension cables available as a separate code.

APPLICATIONS

Production areas, car parks, laboratories and warehouses.



	art.	K	PF		L	L1	L2	
New	S1L102N	4000	0,9	100°	100	160	1200	10
New	S1L102C	6400	0,9	100°	100	160	1200	10
New	S1L202N	4000	0,9	100°	100	160	1500	10
New	S1L202C	6400	0,9	100°	100	160	1500	10

Available in autumn 2020

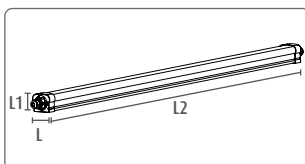

WATERTIGHT S2 IP65



Housing 1 LED Tube

Fixture designed to house LED Tubes



Housing 2 LED Tubes

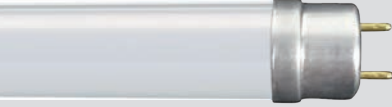

WATERTIGHT S2 IP65

TYPE

Linear TRI-PROOF luminaire for surface or suspended installations.

CHARACTERISTICS

Complete with G13 lamp holder for use with replaceable T8 LED tubes, version for one or for two tubes.
AISI 316 stainless steel hinges. Quick opening mechanism for cabling. Can be easily connected in series thanks to the quick contact terminals.

MATERIALS

Polycarbonate body; polycarbonate screen with internal photoetching for better light diffusion.

ASSEMBLY

'Snap on' AISI 316 stainless steel brackets for ceiling or suspension installation.
Adjustable suspension cables available as a separate code.

APPLICATIONS

Production areas, car parks, laboratories and warehouses.



art.	K	PF		L	L1	L2	
New S2T101N	4000	0,9	100°	100	65	1200	10
New S2T102N	4000	0,9	100°	100	100	1200	10
New S2T201N	4000	0,9	100°	100	65	1500	10
New S2T202N	4000	0,9	100°	100	100	1500	10

Available in autumn 2020

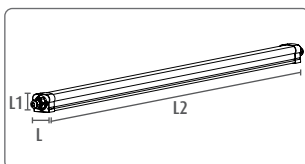



Industrial

HIGH BAY

NEW



126 BASIC

HB3
IP65

NEW



128 BASIC

HBL BEATRIX
IP65



130 PLUS

PANTH
SL2

NEW



132 PRO

HB2 PRO
IP65

NEW

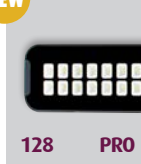

128 PRO

HBL BEATRIX
IP65

HB3 - HIGH BAY

Minimum thickness;
onboard driver



HB3 - HIGH BAY

TYPE

Suspension fixture for installations in large commercial and industrial spaces, equipped with an aluminium reflector with a 110° beam opening.

CHARACTERISTICS

A monoblock body just 4,5cm thick. The entire body of the fixture is laminated to optimise heat dissipation. Integrated power supply, solid structure suitable for use in difficult situations. Free-wire cabling. Replaces discharge lamps up to 400W.

MATERIALS

Powder coated die-cast aluminum body.

APPLICATIONS

Professional lighting ideal for industrial environments and large indoor spaces.

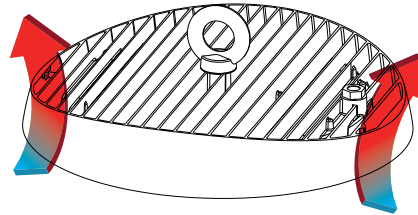

Optimised design to maximise heat exchange

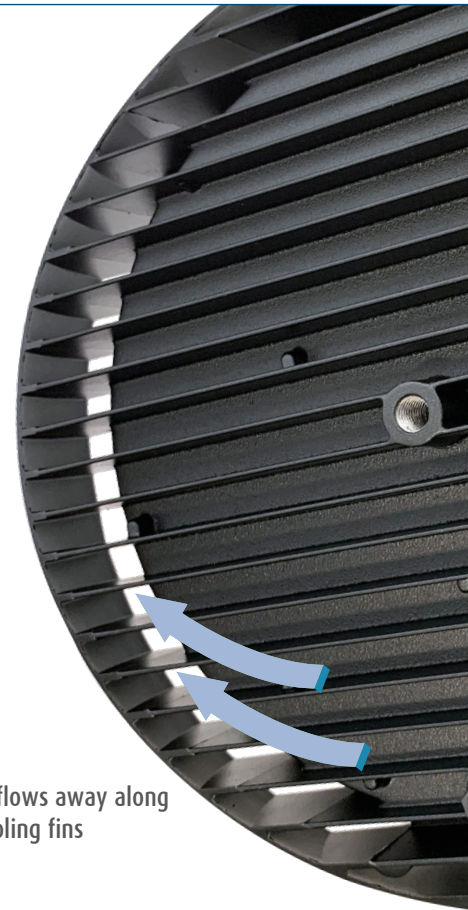

Water flows away along the cooling fins

BASIC	220-240V 50/60Hz	Ra>80		30000h L70	IP65	IK06	-25° +45°C		G3	A++ A+ A	Risk Group 1
--------------	---------------------	-------	--	---------------	------	------	---------------	--	----	----------------	-----------------

art.	W	lm	cd	K	PF		Ø	L	L1			
New HB3-100	100	10000	4900	4000	0,9	110°	270	52	100	1600	8011905	941291 1
New HB3-150	150	15000	7300	4000	0,9	110°	270	52	100	1635	8011905	941307 1
New HB3-200	200	20000	9800	4000	0,9	110°	320	51	102	2365	8011905	941314 1



art.	Ø	L		
New KTHB3-100-PCR Polycarbonate reflector for HB3-100W/HB3-150W	385	82	8011905	960049 1
New KTHB3-200-PCR Polycarbonate reflector for HB3-200W	414	143	8011905	960032 1



New KTHB3-100-R60 Aluminium reflector 60° for HB3-100W/ HB3-150W	385	80	8011905	960063 1
New KTHB3-200-R60 Aluminium reflector 60° for HB3-200W	414	140	8011905	960056 1



New KTHB3-100-G Bracket for HB2-100W/ HB2-150W			8011905	960025 1
New KTHB3-200-G Bracket for HB2-200W			8011905	960018 1

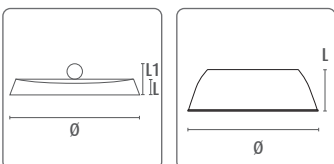

HBL - BEATRIX LINEAR HIGH BAY



HBL - BEATRIX LINEAR HIGH BAY

TYPE

Suspension fixture for installations in large commercial and industrial spaces; uses SMD technology.

CHARACTERISTICS

Fixtures with single optics to maximise flux. The collection is divided into versions with standard drivers and those with Tridonic drivers.

HBL PRO can be used in series of up to 10 fixtures for the 40W model and up to 6 fixtures for the 80W model.

OPTIC

Optical systems composed of micro optics that direct the flux of the LED sources. The LED sources are protected by sealed optics to be used in dusty or dirty environments.

MATERIALS

Extruded PC body; glass front screen.

MOUNTING

Easy cabling using an IP65 connection box attached to the body of the fixture. Wall/ceiling installation with the brackets supplied or suspension mounted. The fixture is equipped with a 1m suspension cable. The separate accessory code for suspension installation includes 3m length cables.

BASIC	200-240V 50/60Hz	Ra>80		30000h L70 B20	IP65	IK08	-25° +35°C		G3	A++ A+ A	Risk Group 1
--------------	---------------------	-------	--	-------------------	------	------	---------------	--	-----------	----------------	-----------------

	art.	photo	W	lm	cd	K		PF	L	L1	L2			
New	HBL6001N	1	40	3600	2800	4000	60°	0,9	606	120	53.2	1250	8011905	6
New	HBL12001N	2	80	7200	5900	4000	60°	0,9	1147	120	53.2	2350	941338	6

PRO	200-240V 50/60Hz	Ra>80		50000h L70 B20	IP65	IK08	-25° +35°C		G5/h24	A++ A+ A	Risk Group 1
------------	---------------------	-------	--	-------------------	------	------	---------------	--	---------------	----------------	-----------------

	art.	photo	W	lm	cd	K		PF	L	L1	L2			
New	HBL6002N	3	40	3600	2800	4000	60°	0,9	606	120	53.2	1250	941345	6
New	HBL12002N	4	80	7200	5900	4000	60°	0,9	1147	120	53.2	2350	941352	6



	art.	L		
	KT-BHL-SP Adjustable suspension wires kit	3000	943356	1

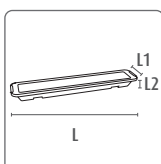

For the photometrics see the special section or consult the web site.

PANTH - SL2



200W

150W

100W



PANTH - SL2

TYPE

LED projector for outdoor, indoor and construction site application.

CHARACTERISTICS

Compact dimensions: easy to use and handle. Equipped with fixing bracket, adjustable on the vertical axis. Free wire for professional use (1.5 m long). It can be connected to motion or twilight sensors.

MATERIALS

Grey painted pressed metal body. Completely sealed IP65 driver.

NB

Non Dimming.



THE 200W MODEL CAN ALSO BE USED AS A HIGH BAY: 400 LUX AT 5 METRES HEIGHT.

PLUS	220-240V 50/60Hz	Ra>80		40000h L70	IP65	-25° +35°C		G3		Risk Group 1
-------------	---------------------	-------	--	---------------	------	---------------	--	----	--	-----------------

art.	W	lm	cd	K		L	L1	L2			
PANTH-SL1002	100	11000	5380	4000	100°x60°	300	325	92,5	2300	61810	5
PANTH-SL1502	150	13500	6780	4000	100°x60°	360	377	95,5	3000	61841	5
PANTH-SL2002	200	20000	10600	4000	100°x60°	360	480	216	4100	61858	2

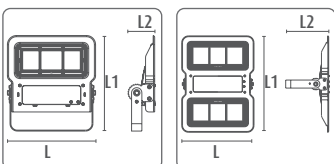

HB2 - HIGH BAY

FLICKER
FREE

100W 90°
100W 90° DALI
150W 90°
150W 90° DALI



200W 120°
200W 120° DALI



The optional aluminium reflector provides direction the light: ideal in the workplace where video terminals or machines with LCDs are used, the antiglare optic prevents light from being reflected on screens positioned under the fixture.

HB2 - HIGH BAY

TYPE

Suspension fixture for installation in large commercial or industrial spaces; it uses SMD technology. Also available in a DALI version.

CHARACTERISTICS

It is composed of an independent power supply system connected to the body of the fixture with small columns for improved thermal management. The optical unit is integrated into the aluminium body for perfect heat dissipation. The fixture body can be completed with an aluminium or polycarbonate reflector to obtain a different aesthetic and antiglare effect.

OPTIC

The optical system is composed of an array of SMD optimised lenses with a beam opening of 90° for the 100W and 150W models and 120° for 200W models.

MATERIALS

Grooved die-cast aluminium for heat dissipation.

ASSEMBLY

Equipped with a mounting ring for suspension installation. For ceiling or wall installation order the accessory code that comprises the bracket and the relative accessories.



To obtain a more attractive aesthetic and reduce glaring the luminaire can be completed with an aluminium or a transparent polycarbonate reflector.

PRO	220-240V 50/60Hz	Ra>80	50000h L70 B20	IP65	IK08	-25° +45°C		G5/h24	A++ A+ A	Risk Group 1
------------	---------------------	-------	-------------------	------	------	---------------	--	--------	----------------	-----------------

	art.	W	lm	cd	K		PF	Ø	L	L1			
	HB2-100	100	13000	7200	4000	90°	0,92	262	150	174	2350	8011905	1
	HB2-150	150	20000	11200	4000	90°	0,92	305	150	182	3200	941017	1
	HB2-200	200	26000	9300	4000	120°	0,92	347	150	193	3800	929893	1
	art.	W	lm	cd	K		PF	Ø	L	L1			
	HB2-100DALI	100	13000	7200	4000	90°	0,92	262	150	174	3000	938680	1
	HB2-150DALI	150	20000	11200	4000	90°	0,9	305	150	182		941000	1
	HB2-200DALI	200	26000	9300	4000	120°	0,92	347	150	193	3500	933180	1



art.		Ø	L		
New KTHB2-100-PCR	Polycarbonate reflector for HB2-100W/HB2-150W	380	122	943370	1
New KTHB2-200-PCR	Polycarbonate reflector for HB2-150W/HB2-200W	435	125	943363	1



KTHB2-100-R	Aluminium reflector for HB2-100W/ HB2-150W	380	122	929497	1
KTHB2-200-R	Aluminium reflector for HB2-200W	435	125	929503	1



KTHB2-100-F	Bracket for HB2-100W/ HB2-150W			929473	1
KTHB2-200-F	Bracket for HB2-200W			929480	1

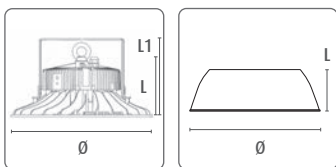

For the photometric data visit the web site.



Outdoor

FLOODLIGHT PROJECTORS



PANTH ST
IP65



PANTH - ST HP
IP65



PANTH EVO
IP65

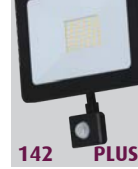

PANTH EVO
PIR SENSOR
IP54



PANTH
SL2

PANTH ST



PANTH ST

TYPE

High power, ultra-thin LED projector; can be used outdoor and indoor.

CHARACTERISTICS

It can be connected to motion or twilight sensors.

OPENING/BEAM

120°

MATERIALS

Painted diecast aluminium. Black colour.

NB

Free wire for professional use (30 cm long).

BASIC	220-240V 50/60Hz	Ra>80		15000h L70 B30	IP65	-25° +35°C		G2	A++ A+ A	Risk Group 1
--------------	---------------------	-------	--	-------------------	------	---------------	--	----	----------------	-----------------

art.	W	lm	cd	K	PF		L	L1	L2		8011905	
PANTH-ST10W	10	740	380	3000	0,9	120°	90	80	26	185	933135	5
PANTH-ST10N	10	750	380	4000	0,9	120°	90	80	26	185	932299	5
PANTH-ST10C	10	760	385	6000	0,9	120°	90	80	26	185	931636	5
PANTH-ST20W	20	1540	645	3000	0,9	120°	127	119	27	320	933142	5
PANTH-ST20N	20	1560	650	4000	0,9	120°	127	119	27	320	932305	5
PANTH-ST20C	20	1580	655	6000	0,9	120°	127	119	27	320	931629	5
PANTH-ST30W	30	2400	900	3000	0,9	120°	183	179	27	610	933159	5
PANTH-ST30N	30	2450	915	4000	0,9	120°	183	179	27	610	932312	5
PANTH-ST30C	30	2500	925	6000	0,9	120°	183	179	27	610	931612	5
PANTH-ST50W	50	3900	1440	3000	0,9	120°	226	218	29	870	933166	1
PANTH-ST50N	50	4000	1470	4000	0,9	120°	226	218	29	870	932329	1
PANTH-ST50C	50	4100	1500	6000	0,9	120°	226	218	29	870	931605	1

• Minimum Order Quantity

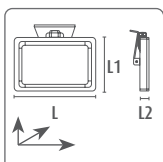

PANTH ST HP



100W

150W

250W

PANTH ST HP

TYPE

LED projector 'minimal design' for outdoor and indoor applications.

CHARACTERISTICS

It can be connected to motion or twilight sensors.

OPENING/BEAM

120°

MATERIALS

Painted diecast aluminium. Black colour.

NB

Free wire for professional use (1 m long).

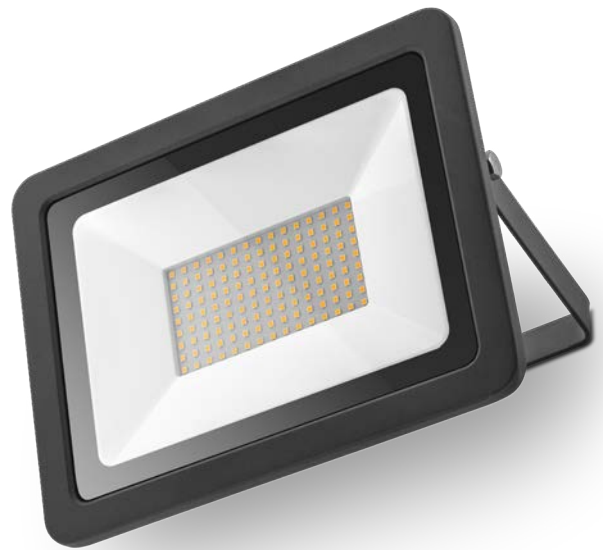

BASIC	220-240V 50/60Hz	Ra>80		25000h L70 B30	IP65	-25° +35°C		G2		Risk Group 1
--------------	---------------------	-------	--	-------------------	------	---------------	--	----	--	-----------------

art.	W	lm	cd	K	PF		L	L1	L2			
New PANTH-ST100W	100	8590	3100	3000	0,9	120°	269	209	34	141	8011905	10
New PANTH-ST100N	100	9000	3300	4000	0,9	120°	269	209	34	141	941031	10
New PANTH-ST100C	100	9000	3300	6500	0,9	120°	269	209	34	141	941024	10
New PANTH-ST150W	150	13590	4900	3000	0,9	120°	381	280	36	279	941079	5
New PANTH-ST150N	150	14000	5100	4000	0,9	120°	381	280	36	279	941062	5
New PANTH-ST150C	150	14000	5100	6500	0,9	120°	381	280	36	279	941055	5
New PANTH-ST250W	250	23590	8600	3000	0,9	120°	445	336	46	427	941109	4
New PANTH-ST250N	250	24000	8700	4000	0,9	120°	445	336	46	427	941093	4
New PANTH-ST250C	250	24000	8700	6500	0,9	120°	445	336	46	427	941086	4

• Minimum Order Quantity

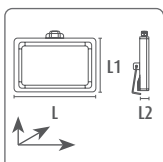

L = 100cm

PANTH EVO



50W



10W



20W



30W

DIFFERENT MOUNTING OPTIONS

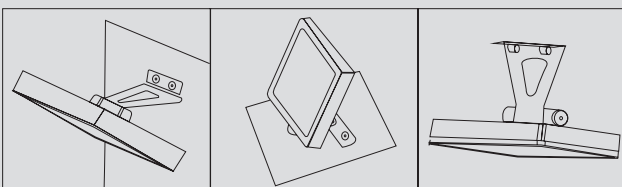

PANTH EVO

TYPE

LED projector 'minimal design' for outdoor and indoor applications.

CHARACTERISTICS

It can be connected to motion or twilight sensors.

OPENING/BEAM

120°

MATERIALS

Painted die-cast metal body.

NB

Free wire for professional use (1 m long).



Z	1	****
---	---	------

Emergency fixture with a centralised power supply for emergency lighting.

art.	W	lm	cd		K	PF	▲	L	L1	L2		80119058	
PANTH-B10N	10	900	350	■	4000	0,94	120°	116	82	23	205	49818	30
PANTH-WH10W	10	900	350	□	3000	0,94	120°	116	82	23	205	62671	30
PANTH-WH10N	10	900	350	□	4000	0,94	120°	116	82	23	205	55482	30
PANTH-B20N	20	1850	700	■	4000	0,94	120°	147	103	29	360	49825	20
PANTH-WH20W	20	1850	700	□	3000	0,94	120°	147	103	29	360	62664	20
PANTH-WH20N	20	1850	700	□	4000	0,94	120°	147	103	29	360	55505	20
PANTH-B30N	30	2650	950	■	4000	0,98	120°	189	133	29	580	49832	20
PANTH-WH30W	30	2650	950	□	3000	0,98	120°	189	133	29	580	62657	20
PANTH-WH30N	30	2650	950	□	4000	0,98	120°	189	133	29	580	55529	20
PANTH-B50N	50	4500	1600	■	4000	0,96	120°	221	155	34	820	49849	10
PANTH-WH50W	50	4500	1600	□	3000	0,96	120°	221	155	34	820	62640	10
PANTH-WH50N	50	4500	1600	□	4000	0,96	120°	221	155	34	820	55543	10

ADJUSTABLE ON THE HORIZONTAL AXIS

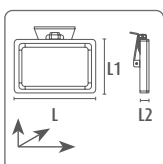

PANTH EVO PIR SENSOR



50W



30W



Adjustable ambient lighting

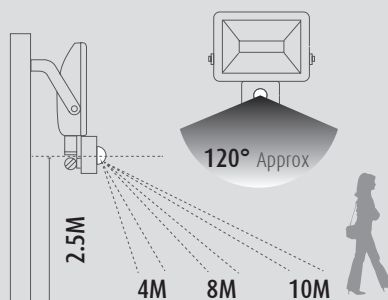
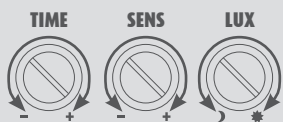

FOR SAFETY AND ENERGY SAVING

PANTH EVO PIR SENSOR

TYPE

LED projector 'minimal design' for outdoor and indoor applications with PIR sensor.

CHARACTERISTICS

Twilight and movement sensor: 10 meters detection range.

OPENING/BEAM

120°

MATERIALS

Painted diecast aluminium. Black colour.

NB

Free wire for professional use (1 m long).

PIR SPECS:

Ambient lighting: 3-2000LUX (adjustable)

Switch on time: min: 10sec+3sec

Max: 7min+3min

Installation height: 1.8m+2.5m

Motion Detection Speed: 0.6~1.5m/s

Detection distance: Max.10m (<24°C ta)



PLUS	220-240V 50/60Hz	Ra>80		25000h L70 B20	IP44	-25° +40°C		G3		Risk Group 1
-------------	---------------------	-------	--	-------------------	------	---------------	--	----	--	-----------------

art.	W	lm	cd	K		L	L1	L2	L3		
PANTH-B30NS	30	2650	950	4000	120°	190	29	135	210	80119058	20
PANTH-B50NS	50	4500	1600	4000	120°	221	34	155	230	55833	10

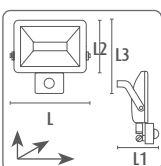



Outdoor

FACADE PROJECTORS

NEW



146 PRO

MINILINI
IP65

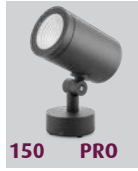

150 PRO

JAZZ
IP65

PROJECTORS



152 BASIC

SPIKE LED
IP65



154 PLUS

UNDERWATER
PROJECTORS
SUBAQ
IP68



156 PLUS

INGROUND WALK-ON
FITTING IP67

MINILINI IP65



MINILINI allow to create a continuous line of light.

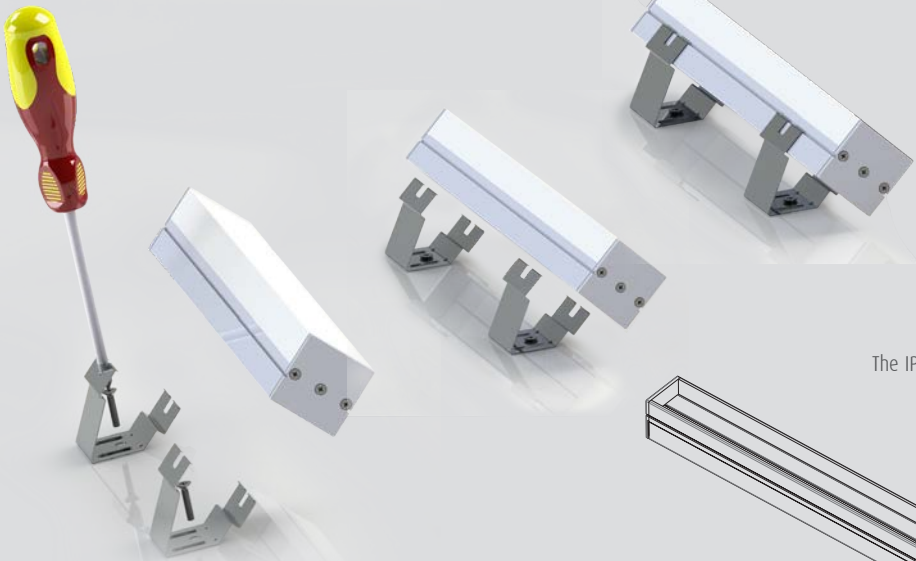

The IP65 wiring is located underneath the luminaire.

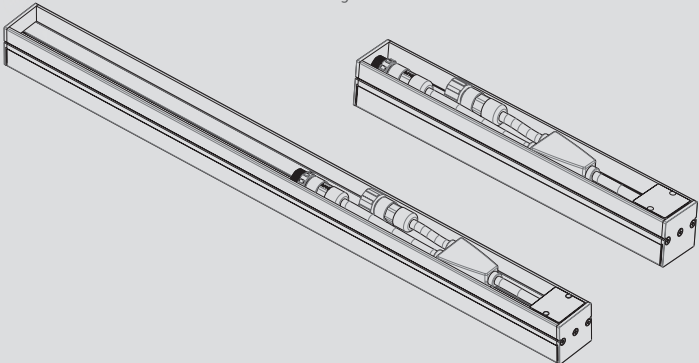

MINILINI IP65

TYPE

Mains voltage architectural linear projector for surface mounted installation.

CHARACTERISTICS

It is constructed from extruded aluminium with an opal polycarbonate cover and is rated IP65 making it suitable for exterior environments: 40 mm wide and 295 or 585 mm long and available in various beam angles and wattages.

Accessories include a selection of fixed and angled surface mounting brackets providing installation uniformity or adjustable brackets for further flexibility.

MINILINI is complete with integrated protection from voltage spikes.

DIMMABILITY

230V: Dimmable 10-100%; TRIAC Leading edge

CONNECTIONS

Maximum connection length: see table.

ASSEMBLY

Choice of surface mounting brackets with different fixed angles - 15°, 30°, 45° - or with adjustable brackets of different heights to be ordered with separate codes.



Driver on board



Steel brackets of different heights

BINNING

ANSI/SDCM: 2 step.
2700K - 3000K - 3500K

DIMMABILITY

Dimmable 10-100%
TRIAC Leading edge

Converter Wiring Diagram

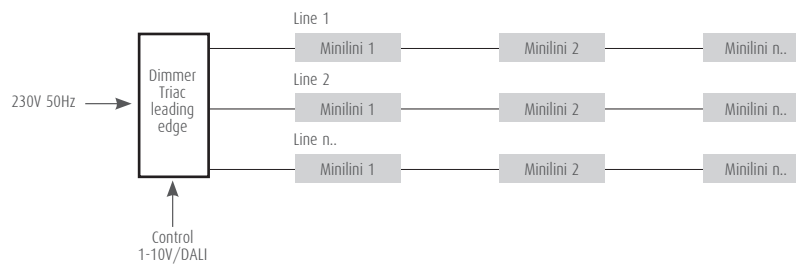

MINILINI CONFIGURATIONS + CONNECTION TABLE

POWER	WATT SET	Modules size	Max N# of modules	Max length each line*	Max W power
4W*	1x4W	29,5cm	72	20,4m	288W
8W*	1x8W	29,5cm	36	10,2m	288W
8W*	2x4W	58,5cm	36	21m	288W
16W	1x16W	29,5cm	18	5,1m	288W
16W*	2x8W	58,5cm	18	10,5m	288W
32W	2x16W	58,5cm	9	5,1m	288W

* Configurations can be made to order and for quantities

MINILINI IP65

PRO	220-240V 50/60Hz	Ra>90	50000h L70 B20	IP65		-25° +35°C		G5/h24	A++ A+ A	Risk Group 1
------------	---------------------	-------	-------------------	------	--	---------------	--	--------	----------------	-----------------

art.	W	lm	cd	K	PF		L	L1	L2		
New MNLO16EP12FLO30E	16	1400	460	3000	0,95	90°	40	40	295	80119058 955311	1
New MNLO16EP12FLO40E	16	1400	460	4000	0,95	90°	40	40	295	955328	1
New MNLO32EP24FLO30E	32	2800	930	3000	0,95	90°	40	40	585	955335	1
New MNLO32EP24FLO40E	32	2800	930	4000	0,95	90°	40	40	585	955342	1

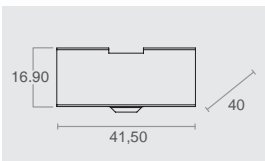

art Description

KTMNLBKTVERT 316 steel surface mounting bracket for vertical positioning (10 pieces). We recommend using 2 for every module.

1

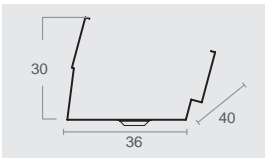

art Description

KTMNLBKT15 316 steel surface mounting bracket with an angle of 15° (10 pieces).

1

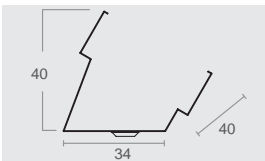

art Description

KTMNLBKT30 316 steel surface mounting bracket with an angle of 30° (10 pieces).

1

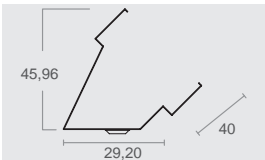

art Description

KTMNLBKT45 316 steel surface mounting bracket with an angle of 45° (10 pieces).

1

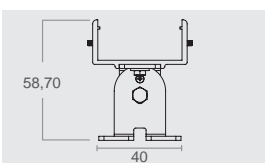

art Description

ORDEV1 35 mm surface mounting bracket, can swivel 90° in both directions (2 pieces).

1

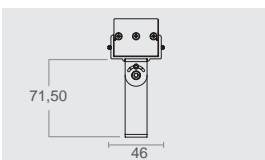

art Description

ORDEV2* 71 mm surface mounting bracket, can swivel 90° in both directions (2 pieces).

1

* Only upon order

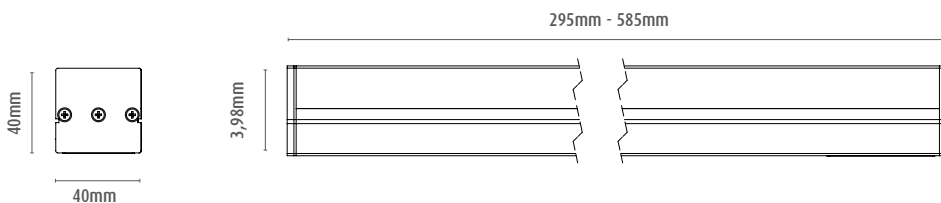



JAZZ PROJECTORS IP65



Precision multifaceted optics.



25° - 60°
available
upon
request

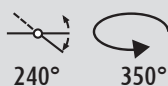

JAZZ PROJECTORS IP65

TYPE

LED projector with COB technology for outdoor spot lighting.

CHARACTERISTICS

Sleek design that can be used in any setting; adjustable to 240°. Projector with base with integrated driver.

OPTICS

LED Chip on Board, high efficiency, Ra 85. Adjustable from 0° to 240° on the vertical axis and 350° on the horizontal axis.







MATERIALS

Anthracite grey colour, powder coated anodised aluminium body.

JAZZ03: projector with a base with integral LED driver.

MATERIALS

Anthracite grey colour, powder coated anodised aluminium body.

PRO	40-52V DC 850 mA		Ra>85	50000h L70 B20	-25° +35°C		G5/h24		A++ A+ A	Risk Group 1			
art.	W	lm	cd	K	PF		L	L1	L2	Ø		 8011905	
JZ03BNW *	30	2700	4100	4000	0,9	40°	156	210	95	100	1700	862442	1
JZ03BWW	30	2800	3250	3000	0,9	55°	156	210	95	100	1700	934170	1

* Subject to minimum order.

Dimmable (TRIAC, LEADING EDGE). Dimmers' list on www.duralamp.it

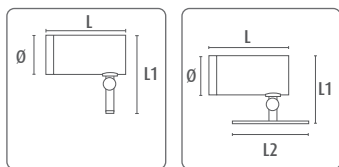

SPIKE LED

TYPE

Garden spike LED light: classic use with modern technology.

CHARACTERISTICS

Diffused light from a smaller point of origin: only 128mm above ground. Complete with an anti-glare cover.

MATERIALS

Die-cast aluminium body; epoxy painted metal body and spike.

NB

Do not use with drivers for halogen lamps; 12V AC/DC power supply not included.



BASIC	12V AC/DC	Ra>80		25000h L70 B30	IP67	IK10	-25° +35°C		G3	A++ A+ A	Risk Group 1
--------------	-----------	-------	--	----------------	------	------	------------	--	----	----------------	--------------

art.	W	lm	cd	K	PF		Ø	L			
LND0760NW	7	430	434	4000	0,70	60°	56	290	290	80119058	50

Can be used with Duralamp's driver for LEDs:
 DELT20A-12 MAX 1 light fixture
 DELT50A-12 MAX 3 light fixtures

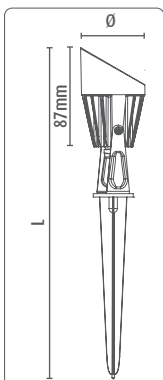



PICCHETTO

Orientable and almost invisible

RGB or white light

UNDERWATER PROJECTORS

6W



WHITE LIGHT VERSION
6W



ADJUSTABLE 180° FOR SWIMMING
POOLS AND FOUNTAINS

15W



18W



RGB VERSION CONTROLLED VIA DMX

RGB version controlled via DMX with integrated electronic controller: we recommend the WALL TOUCH panel, code ZKTPC-RGBW.

Without a control signal, the device goes into an automatic mode and cycles a sequence of pre-set colours.

SUBAQ

TYPE

IP68 projector for underwater and outdoor applications.

CHARACTERISTICS

Completely sealed projector for use in swimming pools and fountains. Swivel body mounted on a bracket and complete with surface fixing plate.

Free wires connection.

MATERIALS

AISI 316 Stainless steel body and polycarbonate cover.

Material resistant to chlorine and swimming pool additives.

NB

Operating Voltage: 12V, 50Hz LED driver not included. Do not use with dimmers. Max depth underwater: 5.0 mtr.

PLUS	Ra>80		20000h L70	IP68	-25° +35°C		G3	A++ A+ A	Risk Group 1
-------------	-------	--	---------------	------	---------------	--	----	----------------	-----------------

12V
AC/DC

art.	W	lm	K		Ø	L		
12PR0615CW	6	400	6000	15°	126	128	80119058 50579	6

Can be used with Duralamp driver for LED
DELT20A-12 MAX 2 fittings

12V
DC

art.	W	lm	K		Ø	L		
12PR1530RGB	15		free wires	30°	147	141	80119058 50586	20
12PR1860RGB	18		free wires	60°	147	141	80119058 50593	20

Can be used with Duralamp driver for LED
DELT50A-12 MAX 1 fitting

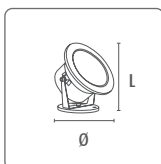

INGROUND WALK-ON IP67 FITTING



7W

Ø80mm



14W

Ø94mm



60°



20W

Ø134,8mm



36°

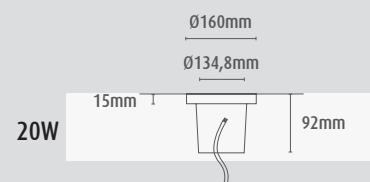
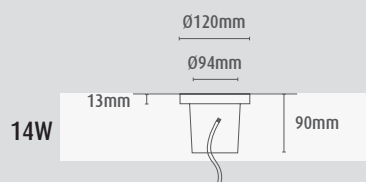
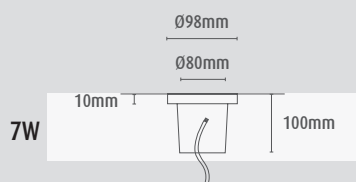
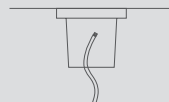

INGROUND WALK-ON IP67

TYPE

LED fixtures with SMD technology for inground installation; walk-on fixtures.

CHARACTERISTICS

Complete with finishing ring and completely sealed transparent glass.

MATERIALS

Metal body, brushed steel ring, shockproof IK10 glass screen; plastic sleeve.

NB

Do not use with drivers for halogen lamps; 12V AC/DC power supply not included.

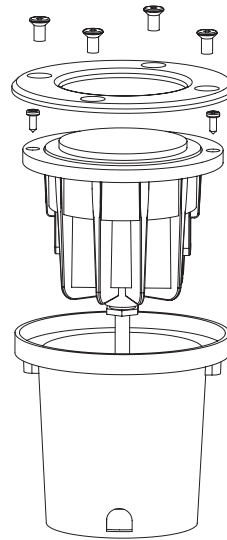

PLUS		12V AC/DC	Ra>80		35000h L70	IP67	IK10	-20° +35°C		G3	A++ A+ A	Risk Group 1
-------------	--	-----------	-------	--	------------	------	------	------------	--	-----------	----------------	--------------

art.	W	lm	cd	K	PF		Ø	L			
DU404530	7	430	430	3000	0,74	60°	98	100	440	39666	30
DU401430	14	1000	1100	3000	0,70	60°	120	90	680	43885	32
DU402030	20	1600	4000	3000	0,70	36°	160	92	1110	43892	16

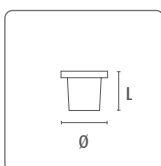

Cut hole

7W = Ø 80 mm ± 2 mm

14W = Ø 94 mm ± 2 mm

20W = Ø 134,8 mm ± 2 mm

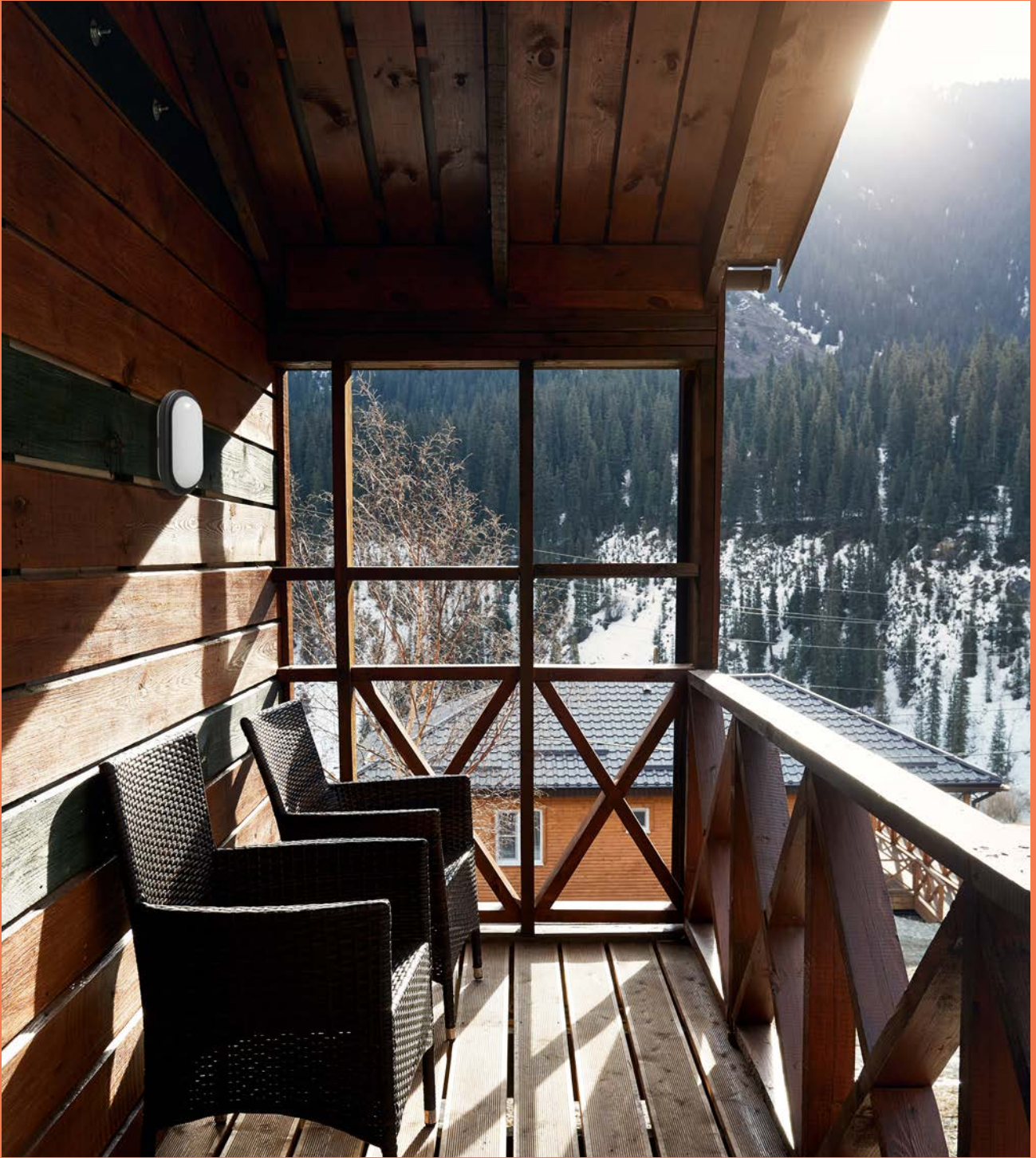

Outdoor

DECORATIVE FIXTURES



160 BASIC-PRO

BULKHEAD
T&O IP65



163 BASIC

BULKHEAD
T&O2 - IP54



164 BASIC

SEGNASENTIERO
IP65

NEW



166 BASIC

ZOE
IP54

BULKHEAD T&O IP65



IP65	IK10
------	------

BASIC	25000h L70
--------------	---------------

PRO	50000h L70
------------	---------------

ACCESSORIES



APPLICATIONS

Stairwell lighting, terraces, corridors, common areas, gardens, bathrooms etc.



BULKHEAD T&O IP65

TYPE

IP65 ceiling/wall light with new generation LED sources using SMD technology.

CHARACTERISTICS

Typically used for diffused lighting for both indoor and outdoor or wet environments (IP65).
Substitutes ceiling fixtures with fluorescent lamps to give immediate lighting without flickering and increased duration.

MATERIALS

Shockproof plastic IK10 body and screen. Driver on board not accessible.

MOUNTING

The bracket attaches to the wall or the ceiling and the fixture is screwed onto the bracket.

NB

Non Dimming. The 50.000 hour version is suitable for public tenders.

220-240V 50/60Hz	Ra>80		IP65	IK10	-20° +35°C		A++ A+ A	Risk Group 0
---------------------	-------	--	------	------	---------------	--	----------------	-----------------

	BASIC	25000h L70 B30	G3
--	--------------	-------------------	-----------

art.	W	lm	cd	K	PF		L	Ø			
BH20	20	2000	560	4000	0,9	120°	73	220	432	80119058	10

	BASIC	25000h L70 B30	G3
--	--------------	-------------------	-----------

art.	W	lm	cd	K	PF		L	L1	L2			
BH015	15	1500	410	4000	0,9	120°	63	114	214	278	80119058	10

	PRO	50000h L70 B20	G5/h24
--	------------	-------------------	---------------

art.	W	lm	cd	K	PF		L	Ø			
BH20LL	20	2000	560	4000	0,9	120°	73	220	432	48750	10

	PRO	50000h L70 B20	G5/h24
--	------------	-------------------	---------------

art.	W	lm	cd	K	PF		L	L1	L2			
BH015LL	15	1500	410	4000	0,9	120°	63	114	214	278	494443	10

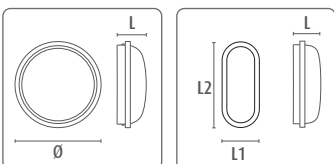





• Minimum Order Quantity

ACCESSORIES T&O





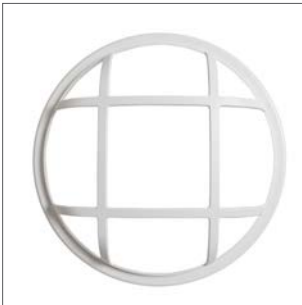

Black or white anti-glare for round bulkhead

art		L	Ø		 80119058	
KTBH20HMB		55	227	62	61032	1
KTBH20HMW		55	227	62	61247	1



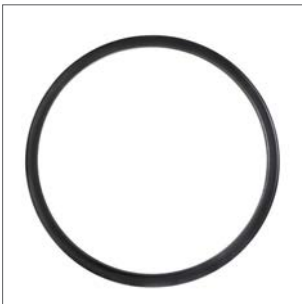

Black or white grid accessory for round bulkhead

art		L	Ø		 80119058	
KTBH20GRB		54	227	65	61216	1
KTBH20GRW		54	227	65	61209	1





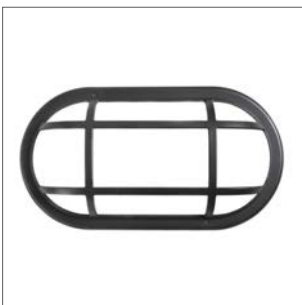

Black ring accessory for round bulkhead

art		L	Ø		 80119058	
KTBH20ARB		24	227	50	61056	1





Black or white grid accessory for oval bulkhead

art		L	L1	L2		 80119058	
KTBH15GRB		120	220	46	50	61230	1
KTBH15GRW		120	220	46	50	61223	1



Black ring accessory for oval bulkhead

art		L	L1	L2		 80119058	
KTBH15ARB		120	220	24	40	61070	1

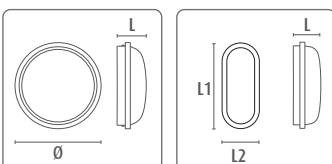

BULKHEAD T&O2

TYPE

Indoor or outdoor surface light fixture.

CHARACTERISTICS

A light yet robust fixture: an essential design that can be used everywhere.

MATERIALS

ABS body for the 8W version and polycarbonate for the other versions: white polycarbonate high transmittance screen.

APPLICATIONS

Residential, the hospitality industry and commerce: dressing rooms, corridors etc...



BASIC	220-240V 50/60Hz	Ra>80		20000h L70 B30	IP54	IK07	G2	A++ A+ A	Risk Group 0
--------------	---------------------	-------	--	-------------------	------	------	----	----------------	-----------------

art.		W	lm	K	PF	Ø	L	8011905	
BH08TN-W		8	560	4000	0,45	160	48	930516	10
BH12TN-W		12	840	4000	0,5	160	48	930523	10

art.		W	cd	K	PF	L1	L2	L	8011905	
BH08EN-B		8	560	4000	0,45	198	99	41	930530	10
BH16EN-B		16	1120	4000	0,5	230	105	41	930547	10

• Minimum Order Quantity

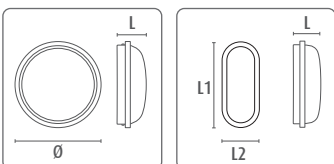

SEGNASENTIERO IP65

TYPE

Wall mounted. Surface pathway markers

CHARACTERISTICS

Three light shielding versions for different lighting effects: full light, downwards and up&down.

MATERIAL

Heat-resistant plastic body; opal polycarbonate screen.

INSTALLATION

Surface with the bracket supplied.

APPLICATIONS

Pathway marker.

LUCE 1



LUCE 50 2



UP&DOWN 3



BASIC	220-240V 50/60Hz	Ra>80		25000h L70 B30	IP65	-25° +35°C		G2		Risk Group 0
--------------	---------------------	-------	--	-------------------	------	---------------	--	----	--	-----------------

art.	Photo	W	lm	K	PF		L	L1	L2		
SW001W	1	4	370	3000	0,51	120°	140	140	51	927424	50
SW001N	1	4	370	4000	0,51	120°	140	140	51	927455	50
SW002W	2	4	180	3000	0,51	120°	140	140	53	927431	50
SW002N	2	4	180	4000	0,51	120°	140	140	53	927462	50
SW003W	3	4	100	3000	0,51	120°	140	140	53	927448	50
SW003N	3	4	100	4000	0,51	120°	140	140	53	927479	50

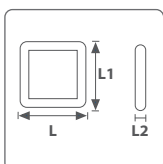



PATHWAY MARKERS IP65

4000K

ZOE STEP-MARKER IP54

TYPE

Die-cast aluminium recessed step-marker.

CHARACTERISTICS

Extremely compact, indirect lighting, staggered reflective compartment to maximise flux and optics protected from insects.

MATERIAL

Powder coated die-cast aluminium in three different colours.

INSTALLATION

Recessed using the springs supplied.

APPLICATIONS

Step-marker. Ideal for use on stairs to improve safety.

1 White



3 Grey



2 Black



BASIC	220/240V 50/60Hz	Ra>80		15000h L70 B20	IP54	-25° +35°C		G2	A++ A+ A	Risk Group 0
--------------	---------------------	-------	--	-------------------	------	---------------	--	----	----------------	-----------------

art.	Photo	W	lm	K	PF	L	L1	L2	8011905	
New ZW01W-W	1	3	90	3000	0,7	84	84	30	941178	10
New ZW01N-W	1	3	90	4000	0,7	84	84	30	941185	10
New ZW01W-B	2	3	90	3000	0,7	84	84	30	941192	10
New ZW01N-B	2	3	90	4000	0,7	84	84	30	941208	10
New ZW01W-G	3	3	90	3000	0,7	84	84	30	941215	10
New ZW01N-G	3	3	90	4000	0,7	84	84	30	941222	10

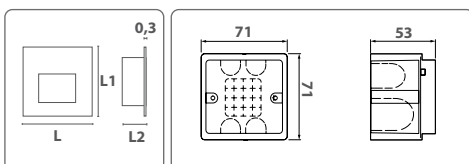

To be installed into in-wall 2 modules junction box (i.e. type 502)

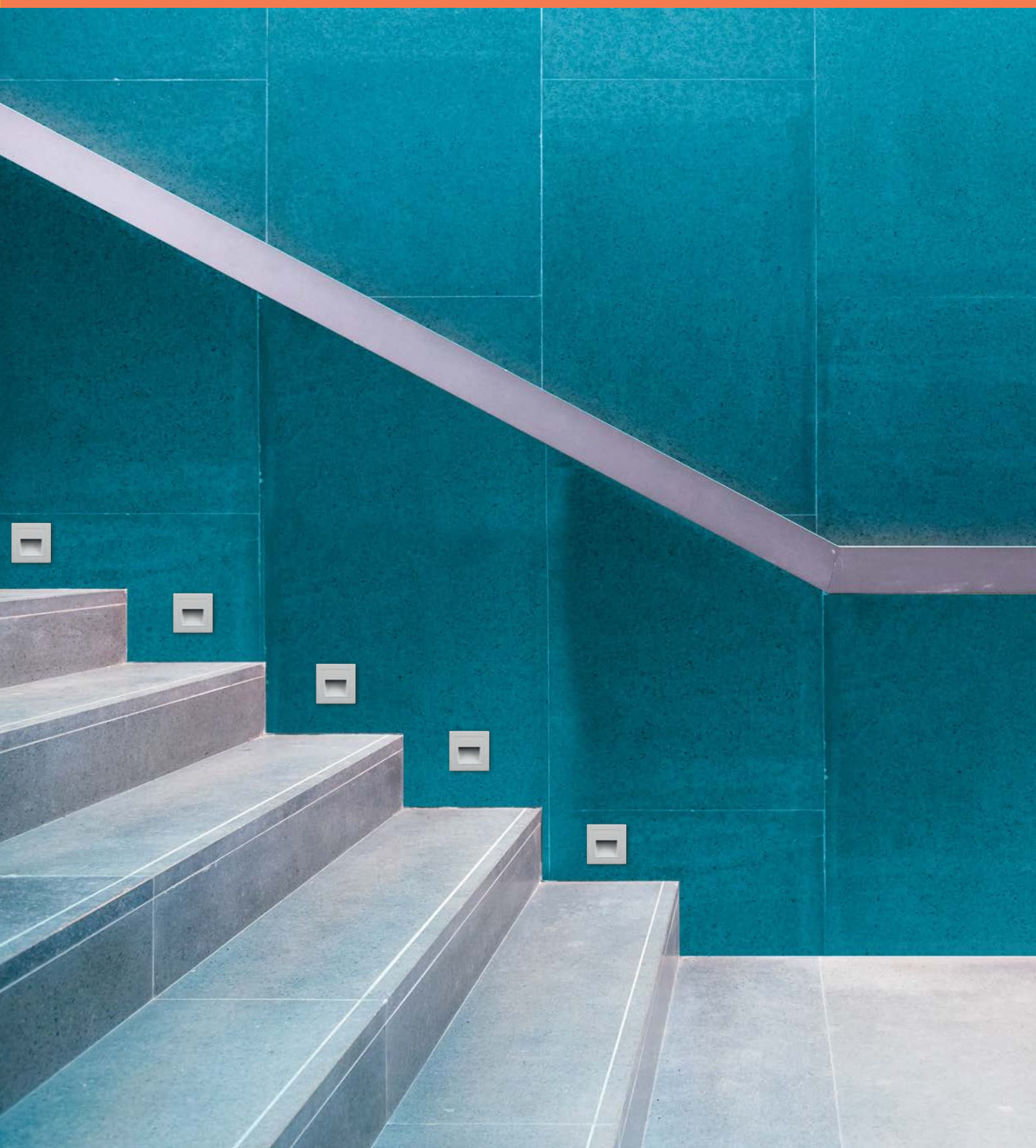

ZOE STEP-MARKER IP54

4000K



MULTICURRENTS CONSTANT CURRENT DRIVER - DIMMABLE

MULTICURRENTS DIMMABLE DRIVER
DALI / PUSH

CHARACTERISTICS

Can be used with fittings with replaceable remote driver.
220÷240V 50/60Hz
Lifetime 50000h.



art.	Max	Volt IN	PF	L1	L2	L3		8011905	
DELT40D-M	40W	220/240V	0,95	108	44	30	137	863210	1



art.	Max	Volt IN	PF	L1	L2	L3		8011905	
DELT40C-M	40W	220/240V	0,95	103	92	30	113	933265	1
DELT65D-M*	60W	220/240V	0,95	125	80	30	245	935474	1

* DALI - 1-10V - Push DALI



DALI PUSH



MULTICURRENTS DRIVER



art.	Max	Volt IN	PF	L1	L2	L3		8011905	
ZKLP10-M	40W	220/240V	0,95	131	44	30	137	933289	1

TRANSFORMERS CONSTANT VOLTAGE OUTPUT ELECTRONIC LED POWER SUPPLY

NOTE

It is advisable not to charge the driver more than 55% of its power in order to consider the in-rush current of LED lamps.

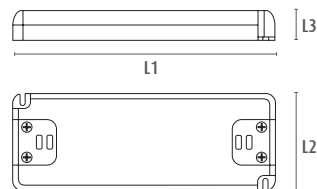

DELT20A-12 DELT50A-12



art.	W	Volt OUT	Volt IN	L1	L2	L3		8011905	
DELT20A-12	20	12V _{DC}	220-240V	154	50	22	59	834616	10
DELT50A-12	50	12V _{DC}	220-240V	185	64	22	274	833343	10

STANDBY LIGHTING FOR FITTINGS

CHARACTERISTICS

Emergency electronic unit for standby lighting suitable for current controlled power LED.

Can be used for maintained or emergency operation.

Can be used with max 2A-90V.

Battery life: 3 hours (Battery pack dimensions: 135x45x23mm); battery inserted in a protective case in accordance with regulations.

Residual flux in emergency 7%.

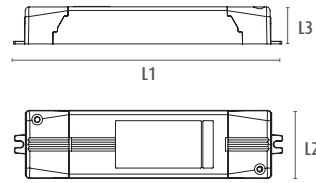

Emergency working voltage (V)	Emergency output current (I)
6-70V	10-62mA



LED EMERGENCY KIT FOR STANDBY LIGHTING* for fittings

art.	Volt IN	L1	L2	L3		8011905	
KTEMR03	220-240V	166,5	46	25	185	933012	1

* As indicated by the UNI EN 1838.

Reserve lighting means lighting that allows you to continue normal activity without substantial change. Fixtures indicated as compatible with the kit have passed the required tests for the reserve lighting category in compliance with EN 60598-2-22

ACCESSORIES FOR FITTINGS

	Safety wire and junction box art				L	80119058	
	LP-SSK	Junction box for connection to the mains, prepared for connection in cascade, equipped with safety suspension kit with steel cable for installations in seismic zones.	1200	54768			1
	Junction box art				L	80119058	
	FASTCON-30	Junction box for connection to the power supply network, prepared for connection in cascade (cable length 27cm)	270	54775			1

TECHNICAL DATA

KEY

PRODUCT CATEGORY KEY

BASIC	Ideal products for markets of consumers who desire a LED product and are seeking the most convenient solution in terms of its cost.
PLUS	Articles with outstanding performance and the best quality-price ratio, the best solution for the majority of applications.
PRO	Products for specific applications and top-level features, especially appreciable by industry professionals.
PROJECT	The articles identified as PROJECT are high-tech articles. Stock is often limited to a few demonstration items and production is activated for specific projects and quantities.

LED WARRANTY SPECIFICATIONS KEY













Warranties on all LED fixtures and LED lamps:

G2	Up to 2 years (4000h/year)*	*4000h = 11h a day x 365 days. Without limitations on the duration of use for the first year, provided the observance of the installation conditions.
G3	Up to 3 years (4000h/year)*	*4000h = 11h a day x 365 days. Without limitations on the duration of use for the first year, provided the observance of the installation conditions.
G4/h24	Full Guarantee 4 years (24h/24h)	h24, provides Total Warranty! The winning element for great projects.
G5/h24	Full Guarantee 5 years (24h/24h)	h24, Total Warranty up to 5 years use!

The specific guarantee that each item enjoys is clearly indicated in the catalog and is subject to compliance to the limitations of use. For details, refer to www.duralamp.it or contact the sales force.

KEY

TABLE PAGES KEY

W	Rated watts for lamps or fixtures
V	Lamp or fixture voltage
lm	Lumen: unit of measurement of the flux emitted by a lamp or fixture. In the case of DURALAMP'S fixtures it indicates the real emission of the fixture in stable conditions. This data is the same used in the photometrics for lighting calculations.
K	K= Kelvin colour temperature indicated in Kelvin.
COLOUR NM	Colour in nanometres, unit of spatial measurement of wavelengths of visible/invisible radiation.
	Lamp cap
PF	Power Factor
	Beam opening
Ø/L1/L2/L3	Diameter and other dimensions expressed in mm except where otherwise indicated.
	Weight of single item article in grams (except where otherwise indicated)
	Minimum packaging: complying with packaging quantities when ordering speeds orders and ensures greater safety of goods.
	Minimum Order Quantity
	Class I Fixture- Fixture with protective earthing
	Class II Fixture - Fixture with double insulation, no earthing required
	Class III Fixture - Low voltage fixture, no earthing required
	Risk group 0: Does not cause any of the risks considered in the IEC/TR 62778:2014 standard
	Risk group 1: Does not cause risks due to normal operating limitations on exposure according to IEC/TR 62778:2014
	Do not cover with insulating material
	Can be used with a dimmer. A list of compatible dimmers is found in individual product files on the web site.
	Not to be used with a dimmer.
UGRxx	UGRxx: Indicates the degree of glare: the lower the number, the lower the glare
Ra>XX	Colour Rendering Index
XXXX00h	Operating life in hours indicated as L70 or L50, always measured at 25° room temperature AT. The lifespan is modified substantially with a rise in temperature.

KEY

LXO	Operating life of a LED fixture or lamp maintaining the indicated flux: L70= 70% flux; L50= 50% flux.
IK08	IK Code, International Protection Marking, classifies and rates the degree of protection for light fixtures against external mechanical impact. IK01 0,15 Joule IK02 0,20 Joule IK03 0,35 Joule IK04 0,5 Joule IK05 0,7 Joule IK06 1,00 Joule IK07 2,00 Joule IK08 5,00 Joule IK09 10,00 Joule IK10 20,00 Joule
IPXX	IP Code, International Protection Marking, classifies and rates the degree of protection for light fixtures against the intrusion of solid particles (first number) and water (second number). IP20 protected against solid objects up to Ø 12 mm. IP23 protected against solid objects up to Ø 12 mm and sprays of water. IP40 protected against solid objects over Ø 1 mm. IP43 protected against solid objects over Ø 1 mm and sprays of water. IP44 protected against solid objects over Ø 1 mm and splashed water. IP54 protected against dust and splashed water. IP55 protected against dust and low pressure jets of water. IP65 Totally protected against dust and low pressure jets of water. IP66 Totally protected against dust and strong jets of water. IP67 Totally protected against dust and temporary immersion. IP68 Totally protected against dust and immersion in water (with an indication of the permitted depth in metres).
IPVI IPVO	IP rating of the internal housing side (VI) and Optic side IP rating (VO)

All measurements are expressed in mm except where expressly indicated.

NB

Available on order: the message "Available on order" often appears in the catalogue. We've added it to offer our customers the broadest choice option. Careful though: if an article is available "on order", it means that it is not readily available in stock and only minimum quantities are available for purchase. We therefore recommend that you contact sales for further details.



CERTIFIED QUALITY

All Duralamp products are CE marked, ie they comply with all applicable European Directives. The UL mark is issued after certification of the product by third parties such as UL, an independent, non-governmental and non-profit organisation whose mission is to ensure that products conform to standards set by ANSI, the American National Standards Institute. UL certification is therefore a Quality and Safety mark and is required for products to be used in the United States and countries that make reference to the same standards.

The EAC mark is the Euroasian Conformity mark required for exporting products to the Customs Union of Russia, Belarus, Armenia, Kazakhstan, Kyrgyzstan. It is comparable to the CE mark and refers to the declaration of compliancy to the technical standards required by the Eurasian Customs Union.

CERTIFIED COMPANY



Duralamp operates under ISO 9001, an international reference standard for quality management of all company processes.

TECHNICAL ANALYSIS

lm

FLUX AND EFFICIENCY

Luminous Flux and Efficiency represent the key information for the evaluation of the performance of a product. What do they represent exactly? Luminous flux represents the emission of the LED source, that is the total amount of light produced by the light source. Efficiency represents the ration between the emission and the power absorbed by the source, that is the total amount of emitted light divided per the energy consumed by the LED source. Nowadays there is not a sole way of publishing these data, each company on the market makes its own choice. This means that catalogues of different companies publish different kinds of information, ranging from the data declared by LED producers to values referable to the LED source in peculiar conditions, but also to values that take into account the "loss" due to reflectors, lenses, drivers and so on. In general, the most reliable data is the value measured on the fixture in its effective usage conditions. In order to let our customers have a clearer idea of the declared data, Duralamp specifies for each LED fixture both its effective flux/efficiency values and the values directly referable to the source, as declared by the producer. The purpose of this methodic choice is to simplify the understanding of the data, and, consequently, to provide our customer the immediate possibility of comparison among Duralamp lighting fixtures and those by other brands. The rapid technical progress of LED sources results in continuous changes in terms of luminous flux and, consequently, efficacy. The information provided by the catalogue should therefore be referred to the date of publication - for regularly updated information please visit the site web.

L70

LED LIFESPAN

LED lamps, unlike traditional lamps do not suddenly stop working but gradually decrease their initial flow unless there are defects or electric shocks. A LED lamp is considered to be no longer functioning it reaches 70% of their initial flow (L70). Life tests are performed following standard IES LM-80. The life span of LED lamps is strongly influenced by the lamps operating temperature once they are installed in fixtures. Duralamp fixtures are designed to have a very low LED operating temperature to ensure the lamps have a very long lifespan.

According to the IEC / PAS 62717 standard, the useful life of a LED can be defined with an additional parameter, for example 50'000h L80B10, meaning the period of time (50'000h) in which 10% (B10) of the LED products of the same type has gradually fallen below 80% of the initial nominal flux.

L80 B10

TC

TEMPERATURE AND PERFORMANCE

The working temperature of a LED source has a significant effect on its useful life, maintenance of luminous flux and efficiency. Correct temperature management, i.e. thermal management of the power in use is a crucial factor in ensuring the performance and reliability of products.

The main characteristic to determine reliability of a product and consistency of performance is measuring the junction temperature (Tj), that can be measured indirectly as luminous flux and the useful life are linked to this parameter. Tj values between 60°C and 90°C allow you to have products with high reliability, performance and estimated lifespans that adhere to market demands. Careful attention must be paid when reading the declared data given that LED manufacturers provide data on the flux at a temperature of Tj 25°C, a condition that is not physically possible for normal use where the LED source is turned on and tested in a fraction of a second and does not produce any heat. Duralamp products are measured and characterised for thermal stability to provide real data on everyday use for the catalogue and users. Well-designed fixtures that ensure proper dissipation also ensure constant flow, colour and spectrum parameters as well as reliability and durability in the declared lifespan.



COLOUR CONSISTENCY

LED lamps have extensive production tolerances in relation to chromaticity. For years Duralamp has only used lamps with colour consistency that is measured using the MacAdam Ellipse system. This allows for absolute repeatability of the colour characteristics compared to the binning based system. LED lamps used by Duralamp are at least 3-steps of MacAdam (3SDCM).

Ra

COLOUR RENDERING INDEX CRI or Ra

The colour rendering index CRI indicates the ability of a light source to reveal colours faithfully. Lighting a coloured object with two sources with different CRI will reveal different colours depending on the source used. It is important not to confuse the CRI with data relating to the colour temperature of a source (expressed in K); two sources with the same colour temperature can have different colour rendering indexes. The CRI strongly influences the efficiency of a LED source and many times lighting designers have to choose between the quality and quantity of light. The LED sources that are fitted in products in the Duralamp collection normally have a colour rendering index that reaches CRI 85. In some case there are also sources with a high colour rendering index (CRI>95).

TM30

New TM30 Standard - a more precise colour definition

It is evident that a single index is not sufficient to completely characterize the colour rendering of a source. The TM-30 is the method by which we group together well-known evaluation systems, organized in a systematic way, with the introduction of two other different indexes, the Fidelity Index Rf (which indicates the fidelity of colour rendering) and the Gamut Index Rg (used to evaluate the increase or decrease in saturation), in turn accompanied by a form of graphic representation. Furthermore the method evaluates the illuminant on 99 samples (CES) that reflect the colours of the leaves, flowers, skin tones, paintings, etc. so as to extend our ability to establish its specific rendering.

UGR

UGR (Unified Glare Rating) is a unified factor in the international field developed by the CIE (International Commission on Illumination) to evaluate direct discomfort glare due to the use of lighting products. In the European Standard relating to indoor workplaces UNI EN 12464-1, the UGR varies from a minimum value of 10 (no glare) to a maximum value of 30 (considerable glare). The lower the value the lower the glare. The UGR value needs to be calculated because it takes into account the size and characteristics of the environment, the background luminance (ceiling, wall, etc), the luminance of light fixtures and the position of the latter in relation to the observation point.

UGR classification applications

- <13 imperceptible
- 16 perceptible technical drawings
- 19 perceptible reading, writing, schools, offices, working on a pc
- 22 perceptible industry and crafts
- 25 uncomfortable raw industrial jobs
- 28 uncomfortable railway tracks, warehouses
- >28 intolerable

PHOTOMETRICS KEY

Photometric measurements were taken at the Duralamp Photometric Laboratory. These measurements are performed at a room temperature equal to 25 ± 1 °C as required by UNI EN 13032-1 - Light and lighting - Measurement and presentation of photometric data of lamps and luminaires - Part 1.

The photometric values quoted are dependent on the optical system to which they relate, and from the light source used. In order to improve its production, the Company reserves the right to change these optical systems and consequently relative photometric data without notice.

For ease of use, the photometric curve present within this catalogue is shown and explained below.

On the web site www.duralamp.it the special section "INFO TECH /Eulumdat" provides all the photometric data in ldt. format that is also given on every product data-sheet.

The photometric curves shown in this catalogue are compiled according to the "C-γ" international reference system, where the C0-C180 plane is perpendicular to the fixtures and the C90-C270 plane is parallel to the fixtures, as depicted in the figure. For symmetrical and rotationally symmetric fixtures therefore, a single curve is used.

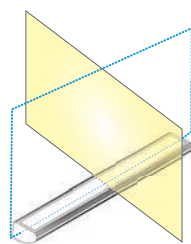

REFERENCE "C-γ"

— TRANSVERSE PLANE
Plane C0° - C180°
Beam angles α

- - - LONGITUDINAL PLANE
Plane C90° - C270°
Beam angles β

POLAR DYAGRAM

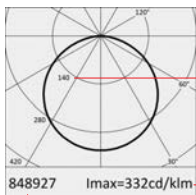

LUMINOUS INTENSITY
PHOTOMETRIC CURVE

IMAX

PHOTOMETRIC CODE: these are the last 6 digits of the item's barcode

4000K Ra90		KELVIN - IRC/Ra
Fixture Power	12W	FIXTURE POWER
Source Flux	1180lm	LED FLUX
Fixture Flux	1180lm	FIXTURE FLUX
Efficacy	98lm/W	EFFICACY
I _{max}	391cd	IMAX

H(m)	D(m)	E _{max} (lx)	
	118°		BEAM ANGLE
1	3.31	391	DISTANCE FROM THE PLAN (m)
2	6.61	98	
3	9.92	43	Ø LUMINOUS CONE (m)
4	13.23	24	
5	16.53	16	MAX ILLUMINATION (lx)

All Duralamp luminaires have integrated LED sources that cannot be separated: therefore the source flux and the luminaire flux show the same value.

PHOTOMETRICS

LESELI CCT

DT40L1CCT

4000K		H(m)	D(m)	Emax(lx)
Ra80			111°	
Fixture Power	12W	1	2.92	432
Source Flux	1200lm	2	5.84	108
Fixture Flux	1200lm	3	8.76	48
Efficacy	100lm/W	4	11.68	27
955441	I _{max} =360cd/klm	I _{max}	432cd	5 14.60 17

DT80L1CCTHP

4000K		H(m)	D(m)	Emax(lx)
Ra80			112°	
Fixture Power	30W	1	2.95	1054
Source Flux	3000lm	2	5.89	264
Fixture Flux	3000lm	3	8.84	117
Efficacy	100lm/W	4	11.79	66
953126	I _{max} =351cd/klm	I _{max}	1054cd	5 14.73 42

LESELI

D30730

3000K		H(m)	D(m)	Emax(lx)
Ra80			113°	
Fixture Power	8W	1	3.03	213
Source Flux	600lm	2	6.07	53
Fixture Flux	600lm	3	9.10	24
Efficacy	75lm/W	4	12.14	13
846374	I _{max} =355cd/klm	I _{max}	213cd	5 15.17 9

D30760

6000K		H(m)	D(m)	Emax(lx)
Ra80			113°	
Fixture Power	8W	1	3.03	213
Source Flux	600lm	2	6.07	53
Fixture Flux	600lm	3	9.10	24
Efficacy	75lm/W	4	12.14	13
862770	I _{max} =355cd/klm	I _{max}	213cd	5 15.17 9

D41540

4000K		H(m)	D(m)	Emax(lx)
Ra80			92°	
Fixture Power	15W	1	2.07	632
Source Flux	1400lm	2	4.14	158
Fixture Flux	1400lm	3	6.21	70
Efficacy	93lm/W	4	8.28	39
843199	I _{max} =451cd/klm	I _{max}	632cd	5 10.34 25

D82530

3000K		H(m)	D(m)	Emax(lx)
Ra80			92°	
Fixture Power	24W	1	2.06	1001
Source Flux	2200lm	2	4.11	250
Fixture Flux	2200lm	3	6.17	111
Efficacy	92lm/W	4	8.23	63
846435	I _{max} =455cd/klm	I _{max}	1001cd	5 10.29 40

D82560

6000K		H(m)	D(m)	Emax(lx)
Ra80			92°	
Fixture Power	24W	1	2.06	1001
Source Flux	2200lm	2	4.11	250
Fixture Flux	2200lm	3	6.17	111
Efficacy	92lm/W	4	8.23	63
862794	I _{max} =455cd/klm	I _{max}	1001cd	5 10.29 40

DT80L1CCT

4000K		H(m)	D(m)	Emax(lx)
Ra80			112°	
Fixture Power	22W	1	2.95	773
Source Flux	2200lm	2	5.89	193
Fixture Flux	2200lm	3	8.84	86
Efficacy	100lm/W	4	11.79	48
953133	I _{max} =351cd/klm	I _{max}	773cd	5 14.73 31

D30740

4000K		H(m)	D(m)	Emax(lx)
Ra80			113°	
Fixture Power	8W	1	3.03	213
Source Flux	600lm	2	6.07	53
Fixture Flux	600lm	3	9.10	24
Efficacy	75lm/W	4	12.14	13
843182	I _{max} =355cd/klm	I _{max}	213cd	5 15.17 9

D41530

3000K		H(m)	D(m)	Emax(lx)
Ra80			92°	
Fixture Power	15W	1	2.07	632
Source Flux	1400lm	2	4.14	158
Fixture Flux	1400lm	3	6.21	70
Efficacy	93lm/W	4	8.28	39
846404	I _{max} =451cd/klm	I _{max}	632cd	5 10.34 25

D41560

6000K		H(m)	D(m)	Emax(lx)
Ra80			92°	
Fixture Power	15W	1	2.07	632
Source Flux	1400lm	2	4.14	158
Fixture Flux	1400lm	3	6.21	70
Efficacy	93lm/W	4	8.28	39
862787	I _{max} =451cd/klm	I _{max}	632cd	5 10.34 25

D82540

4000K		H(m)	D(m)	Emax(lx)
Ra80			92°	
Fixture Power	24W	1	2.06	1001
Source Flux	2200lm	2	4.11	250
Fixture Flux	2200lm	3	6.17	111
Efficacy	92lm/W	4	8.23	63
843205	I _{max} =455cd/klm	I _{max}	1001cd	5 10.29 40

PHOTOMETRICS

ISELI HIGH POWER

D3040HPQ



4000K		H(m)	D(m)	E _{max} (lx)
Ra80			94°	
Fixture Power	30W	1	2.13	1382
Source Flux	3100lm	2	4.26	346
Fixture Flux	3100lm	3	6.39	154
Efficacy	103lm/W	4	8.52	86
843700	I _{max} =446cd/klm	I _{max}	1382cd	5 10.65 55

D83040HPT



4000K		H(m)	D(m)	E _{max} (lx)
Ra80			93°	
Fixture Power	30W	1	2.12	1395
Source Flux	3100lm	2	4.24	349
Fixture Flux	3100lm	3	6.36	155
Efficacy	103lm/W	4	8.48	87
843694	I _{max} =450cd/klm	I _{max}	1395cd	5 10.60 56

ISELI REFLECTOR

D41540A



4000K		H(m)	D(m)	E _{max} (lx)
Ra80			73°	
Fixture Power	15W	1	1.49	949
Source Flux	1300lm	2	2.98	237
Fixture Flux	1300lm	3	4.47	105
Efficacy	87lm/W	4	5.96	59
854959	I _{max} =730cd/klm	I _{max}	949cd	5 7.45 38

D83040A



4000K		H(m)	D(m)	E _{max} (lx)
Ra80			62°	
Fixture Power	30W	1	1.21	1966
Source Flux	2400lm	2	2.43	491
Fixture Flux	2401lm	3	3.64	218
Efficacy	80lm/W	4	4.85	123
860905	I _{max} =819cd/klm	I _{max}	1966cd	5 6.06 79

D82540A



4000K		H(m)	D(m)	E _{max} (lx)
Ra80			62°	
Fixture Power	25W	1	1.21	1556
Source Flux	1900lm	2	2.43	389
Fixture Flux	1900lm	3	3.64	173
Efficacy	76lm/W	4	4.85	97
854928	I _{max} =819cd/klm	I _{max}	1556cd	5 6.06 62

D41560A



6000K		H(m)	D(m)	E _{max} (lx)
Ra80			73°	
Fixture Power	15W	1	1.49	949
Source Flux	1300lm	2	2.98	237
Fixture Flux	1300lm	3	4.47	105
Efficacy	87lm/W	4	5.96	59
863104	I _{max} =730cd/klm	I _{max}	949cd	5 7.45 38

D3030HPQ-D



3000K		H(m)	D(m)	E _{max} (lx)
Ra80			110°	
Fixture Power	30W	1	2.87	966
Source Flux	2700lm	2	5.74	242
Fixture Flux	2700lm	3	8.62	107
Efficacy	90lm/W	4	11.49	60
847760	I _{max} =358cd/klm	I _{max}	966cd	5 14.36 39

D83030HPT-D



3000K		H(m)	D(m)	E _{max} (lx)
Ra80			93°	
Fixture Power	30W	1	2.13	1273
Source Flux	2900lm	2	4.25	318
Fixture Flux	2900lm	3	6.38	141
Efficacy	97lm/W	4	8.50	80
847784	I _{max} =439cd/klm	I _{max}	1273cd	5 10.63 51

D41530A



3000K		H(m)	D(m)	E _{max} (lx)
Ra80			73°	
Fixture Power	15W	1	1.49	949
Source Flux	1300lm	2	2.98	237
Fixture Flux	1300lm	3	4.47	105
Efficacy	87lm/W	4	5.96	59
854867	I _{max} =730cd/klm	I _{max}	949cd	5 7.45 38

D83030A



3000K		H(m)	D(m)	E _{max} (lx)
Ra80			62°	
Fixture Power	30W	1	1.21	1966
Source Flux	2400lm	2	2.43	491
Fixture Flux	2401lm	3	3.64	218
Efficacy	80lm/W	4	4.85	123
860899	I _{max} =819cd/klm	I _{max}	1966cd	5 6.06 79

D82530A



3000K		H(m)	D(m)	E _{max} (lx)
Ra80			62°	
Fixture Power	25W	1	1.21	1556
Source Flux	1900lm	2	2.43	389
Fixture Flux	1900lm	3	3.64	173
Efficacy	76lm/W	4	4.85	97
854935	I _{max} =819cd/klm	I _{max}	1556cd	5 6.06 62

D82560A



6000K		H(m)	D(m)	E _{max} (lx)
Ra80			62°	
Fixture Power	25W	1	1.21	1556
Source Flux	1900lm	2	2.43	389
Fixture Flux	1900lm	3	3.64	173
Efficacy	76lm/W	4	4.85	97
863111	I _{max} =819cd/klm	I _{max}	1556cd	5 6.06 62

PHOTOMETRICS

LESELI DS

DS04L130Q - DS04L130T

	3000K	H(m)	D(m)	E _{max} (lx)		
	Ra80			129°		
	Fixture Power	6W	1	4.22	88	
	Source Flux	310lm	2	8.43	22	
	Fixture Flux	310lm	3	12.65	10	
	Efficacy	52lm/W	4	16.87	5	
	954963	I _{max} =283cd/klm	I _{max}	88cd	5	21.09

DS04L160Q - DS04L160QT

	6000K	H(m)	D(m)	E _{max} (lx)		
	Ra80			129°		
	Fixture Power	6W	1	4.22	99	
	Source Flux	350lm	2	8.43	25	
	Fixture Flux	350lm	3	12.65	11	
	Efficacy	58lm/W	4	16.87	6	
	954867	I _{max} =283cd/klm	I _{max}	99cd	5	21.09

DS08L140Q - DS08L140T

	4000K	H(m)	D(m)	E _{max} (lx)		
	Ra80			131°		
	Fixture Power	18W	1	4.36	361	
	Source Flux	1300lm	2	8.73	90	
	Fixture Flux	1300lm	3	13.09	40	
	Efficacy	72lm/W	4	17.46	23	
	955007	I _{max} =278cd/klm	I _{max}	361cd	5	21.82

DS10L130Q - DS10L130T

	3000K	H(m)	D(m)	E _{max} (lx)		
	Ra80			131°		
	Fixture Power	24W	1	4.36	475	
	Source Flux	1710lm	2	8.73	119	
	Fixture Flux	1710lm	3	13.09	53	
	Efficacy	71lm/W	4	17.46	30	
	955021	I _{max} =278cd/klm	I _{max}	475cd	5	21.82

DS10L160Q - S10L160T

	6000K	H(m)	D(m)	E _{max} (lx)		
	Ra80			131°		
	Fixture Power	24W	1	4.36	525	
	Source Flux	1890lm	2	8.73	131	
	Fixture Flux	1890lm	3	13.09	58	
	Efficacy	79lm/W	4	17.46	33	
	955045	I _{max} =278cd/klm	I _{max}	525cd	5	21.82

LESELI SLIM

D41540SL2

	4000K	H(m)	D(m)	E _{max} (lx)		
	Ra80			129°		
	Fixture Power	6W	1	4.22	119	
	Source Flux	420lm	2	8.43	30	
	Fixture Flux	420lm	3	12.65	13	
	Efficacy	70lm/W	4	16.87	7	
	860912	I _{max} =283cd/klm	I _{max}	119cd	5	21.09

D41540QSL2

	4000K	H(m)	D(m)	E _{max} (lx)		
	Ra80			129°		
	Fixture Power	6W	1	4.22	119	
	Source Flux	420lm	2	8.43	30	
	Fixture Flux	420lm	3	12.65	13	
	Efficacy	70lm/W	4	16.87	7	
	860929	I _{max} =283cd/klm	I _{max}	119cd	5	21.09

DS04L140Q - DS04L140T

	4000K	H(m)	D(m)	E _{max} (lx)		
	Ra80			129°		
	Fixture Power	6W	1	4.22	93	
	Source Flux	330lm	2	8.43	23	
	Fixture Flux	330lm	3	12.65	10	
	Efficacy	55lm/W	4	16.87	6	
	954970	I _{max} =283cd/klm	I _{max}	93cd	5	21.09

DS08L130Q - DS08L130T

	3000K	H(m)	D(m)	E _{max} (lx)		
	Ra80			131°		
	Fixture Power	18W	1	4.36	342	
	Source Flux	1230lm	2	8.73	85	
	Fixture Flux	1230lm	3	13.09	38	
	Efficacy	68lm/W	4	17.46	21	
	954994	I _{max} =278cd/klm	I _{max}	342cd	5	21.82

DS08L160Q - DS08L160T

	6000K	H(m)	D(m)	E _{max} (lx)		
	Ra80			131°		
	Fixture Power	18W	1	4.36	378	
	Source Flux	1360lm	2	8.73	94	
	Fixture Flux	1360lm	3	13.09	42	
	Efficacy	76lm/W	4	17.46	24	
	955014	I _{max} =278cd/klm	I _{max}	378cd	5	21.82

DS10L140Q - DS10L140T

	4000K	H(m)	D(m)	E _{max} (lx)		
	Ra80			131°		
	Fixture Power	24W	1	4.36	500	
	Source Flux	1800lm	2	8.73	125	
	Fixture Flux	1800lm	3	13.09	56	
	Efficacy	75lm/W	4	17.46	31	
	955038	I _{max} =278cd/klm	I _{max}	500cd	5	21.82

D82540SL2

	4000K	H(m)	D(m)	E _{max} (lx)		
	Ra80			131°		
	Fixture Power	18W	1	4.36	389	
	Source Flux	1400lm	2	8.73	97	
	Fixture Flux	1400lm	3	13.09	43	
	Efficacy	78lm/W	4	17.46	24	
	860936	I _{max} =278cd/klm	I _{max}	389cd	5	21.82

D82540QSL2

	4000K	H(m)	D(m)	E _{max} (lx)		
	Ra80			131°		
	Fixture Power	18W	1	4.36	389	
	Source Flux	1400lm	2	8.73	97	
	Fixture Flux	1400lm	3	13.09	43	
	Efficacy	78lm/W	4	17.46	24	
	860943	I _{max} =278cd/klm	I _{max}	389cd	5	21.82

PHOTOMETRICS

RTF
D407840

4000K	H(m)	D(m)	E _{max} (lx)	
Ra80		90°		
Fixture Power	15W	1	2.02	655
Source Flux	1400lm	2	4.03	164
Fixture Flux	1400lm	3	6.05	73
Efficacy	93lm/W	4	8.06	41
833534	I _{max} =468cd/klm	I _{max}	656cd	5 10.08 26

D815840

4000K	H(m)	D(m)	E _{max} (lx)	
Ra80		94°		
Fixture Power	24W	1	2.14	1098
Source Flux	2500lm	2	4.27	275
Fixture Flux	2500lm	3	6.41	122
Efficacy	104lm/W	4	8.54	69
833527	I _{max} =439cd/klm	I _{max}	1098cd	5 10.68 44

D407830

3000K	H(m)	D(m)	E _{max} (lx)	
Ra80		90°		
Fixture Power	15W	1	2.02	655
Source Flux	1400lm	2	4.03	164
Fixture Flux	1400lm	3	6.05	73
Efficacy	93lm/W	4	8.06	41
833299	I _{max} =468cd/klm	I _{max}	656cd	5 10.08 26

D815830

3000K	H(m)	D(m)	E _{max} (lx)	
Ra80		94°		
Fixture Power	24W	1	2.14	1098
Source Flux	2500lm	2	4.27	275
Fixture Flux	2500lm	3	6.41	122
Efficacy	104lm/W	4	8.54	69
833305	I _{max} =439cd/klm	I _{max}	1098cd	5 10.68 44

HELIOS IP65 CCT
DH30L2EXCCT

4000K	H(m)	D(m)	E _{max} (lx)	
Ra90		94°		
Fixture Power	7W	1	2.14	246
Source Flux	560lm	2	4.28	62
Fixture Flux	560lm	3	6.42	27
Efficacy	80lm/W	4	8.56	15
941260	I _{max} =439cd/klm	I _{max}	246cd	5 10.70 10

DH40L2EXCCT

4000K	H(m)	D(m)	E _{max} (lx)	
Ra90		94°		
Fixture Power	12W	1	2.14	422
Source Flux	960lm	2	4.27	105
Fixture Flux	960lm	3	6.41	47
Efficacy	80lm/W	4	8.54	26
941277	I _{max} =439cd/klm	I _{max}	422cd	5 10.68 17

DH80L2EXCCT

4000K	H(m)	D(m)	E _{max} (lx)	
Ra90		94°		
Fixture Power	40W	1	2.14	1406
Source Flux	3200lm	2	4.27	351
Fixture Flux	3200lm	3	6.41	156
Efficacy	80lm/W	4	8.54	88
941284	I _{max} =439cd/klm	I _{max}	1406cd	5 10.68 56

HELIOS IP65
DH30L130EX

3000K	H(m)	D(m)	E _{max} (lx)	
Ra90		94°		
Fixture Power	7W	1	2.14	259
Source Flux	590lm	2	4.28	65
Fixture Flux	590lm	3	6.42	29
Efficacy	84lm/W	4	8.56	16
937478	I _{max} =439cd/klm	I _{max}	259cd	5 10.70 10

DH40L140EX

4000K	H(m)	D(m)	E _{max} (lx)	
Ra90		94°		
Fixture Power	12W	1	2.14	422
Source Flux	960lm	2	4.27	105
Fixture Flux	960lm	3	6.41	47
Efficacy	80lm/W	4	8.54	26
937447	I _{max} =439cd/klm	I _{max}	422cd	5 10.68 17

DH80L140EX

4000K	H(m)	D(m)	E _{max} (lx)	
Ra90		94°		
Fixture Power	40W	1	2.14	1406
Source Flux	3200lm	2	4.27	351
Fixture Flux	3200lm	3	6.41	156
Efficacy	80lm/W	4	8.54	88
937423	I _{max} =439cd/klm	I _{max}	1406cd	5 10.68 56

HELIOS UGR
DH25L140

4000K	H(m)	D(m)	E _{max} (lx)	
Ra90		36°		
Fixture Power	9W	1	0.66	1821
Source Flux	850lm	2	1.32	455
Fixture Flux	850lm	3	1.98	202
Efficacy	94lm/W	4	2.64	114
936808	I _{max} =2142cd/klm	I _{max}	1821cd	5 3.30 73

DH40L140

4000K	H(m)	D(m)	E _{max} (lx)	
Ra90		34°		
Fixture Power	14W	1	0.61	3807
Source Flux	1450lm	2	1.21	952
Fixture Flux	1450lm	3	1.82	423
Efficacy	104lm/W	4	2.42	238
936822	I _{max} =2626cd/klm	I _{max}	3807cd	5 3.03 152

PHOTOMETRICS

HELIOS UGR

DH60L140



4000K		H(m)	D1(m)	D2(m)	E _{max} (lx)		
Ra90			37°	37°			
Fixture Power	28W	1	0.67	0.67	7202		
Source Flux	2800lm	2	1.33	1.33	1800		
Fixture Flux	2800lm	3	2.00	2.00	800		
Efficacy	100lm/W	4	2.66	2.67	450		
936846	I _{max} =2589cd/klm	I _{max}	7249cd	5	3.33	3.34	288

DH80L140



4000K		H(m)	D1(m)	D2(m)	E _{max} (lx)		
Ra90			34°	34°			
Fixture Power	37W	1	0.61	0.60	10340		
Source Flux	3700lm	2	1.21	1.21	2585		
Fixture Flux	3700lm	3	1.82	1.81	1149		
Efficacy	100lm/W	4	2.42	2.42	646		
936860	I _{max} =2795cd/klm	I _{max}	10340cd	5	3.03	3.02	414

LESELI Q PRO

W1SQ30-W



3000K		H(m)	D(m)		E _{max} (lx)		
Ra85			113°				
Fixture Power	26W	1	3.01		694		
Source Flux	2000lm	2	6.02		173		
Fixture Flux	2000lm	3	9.02		77		
Efficacy	77lm/W	4	12.03		43		
	I _{max} =347cd/klm	I _{max}	694cd		5	15.04	28

LESELI MINI PRO

D306TNW



4000K		H(m)	D1(m)	D2(m)	E _{max} (lx)		
Ra80			32°	32°			
Fixture Power	8W	1	0.58	0.57	1826		
Source Flux	680lm	2	1.17	1.14	457		
Fixture Flux	680lm	3	1.75	1.71	203		
Efficacy	85lm/W	4	2.33	2.28	114		
941376	I _{max} =2686cd/klm	I _{max}	1826cd	5	2.91	2.85	73

D306TWW



3000K		H(m)	D1(m)	D2(m)	E _{max} (lx)		
Ra80			32°	32°			
Fixture Power	8W	1	0.58	0.57	1746		
Source Flux	650lm	2	1.17	1.14	436		
Fixture Flux	650lm	3	1.75	1.71	194		
Efficacy	81lm/W	4	2.33	2.28	109		
941369	I _{max} =2686cd/klm	I _{max}	1746cd	5	2.91	2.85	70

LESELI MINI

D307TWW



3000K		H(m)	D(m)		E _{max} (lx)		
Ra80			37°				
Fixture Power	7W	1	0.67		1083		
Source Flux	620lm	2	1.34		271		
Fixture Flux	620lm	3	2.01		120		
Efficacy	89lm/W	4	2.67		68		
862763	I _{max} =1746cd/klm	I _{max}	1083cd		5	3.34	43

D307TNW



4000K		H(m)	D(m)		E _{max} (lx)		
Ra80			37°				
Fixture Power	7W	1	0.67		1135		
Source Flux	650lm	2	1.34		284		
Fixture Flux	650lm	3	2.01		126		
Efficacy	93lm/W	4	2.67		71		
860875	I _{max} =1746cd/klm	I _{max}	1135cd		5	3.34	45

D307QWW



3000K		H(m)	D(m)		E _{max} (lx)		
Ra80			37°				
Fixture Power	7W	1	0.67		1083		
Source Flux	620lm	2	1.34		271		
Fixture Flux	620lm	3	2.01		120		
Efficacy	89lm/W	4	2.67		68		
862756	I _{max} =1746cd/klm	I _{max}	1083cd		5	3.34	43

D307QNW



4000K		H(m)	D(m)		E _{max} (lx)		
Ra80			37°				
Fixture Power	7W	1	0.67		1135		
Source Flux	650lm	2	1.34		284		
Fixture Flux	650lm	3	2.01		126		
Efficacy	93lm/W	4	2.67		71		
860882	I _{max} =1746cd/klm	I _{max}	1135cd		5	3.34	45

BEAM TRACK LIGHT

TB50L140



4000K		H(m)	D(m)		E _{max} (lx)		
Ra90			18°				
Fixture Power	12W	1	0.31		6636		
Source Flux	990lm	2	0.63		1659		
Fixture Flux	990lm	3	0.94		737		
Efficacy	82lm/W	4	1.26		415		
936907	I _{max} =6704cd/klm	I _{max}	6636cd		5	1.57	265

TB60L140



4000K		H(m)	D(m)		E _{max} (lx)		
Ra90			38°				
Fixture Power	20W	1	0.69		3706		
Source Flux	1800lm	2	1.38		927		
Fixture Flux	1800lm	3	2.08		412		
Efficacy	90lm/W	4	2.77		232		
936945	I _{max} =2059cd/klm	I _{max}	3706cd		5	3.46	148

TB80L140



4000K		H(m)	D(m)		E _{max} (lx)		
Ra90			38°				
Fixture Power	30W	1	0.69		5560		
Source Flux	2700lm	2	1.38		1390		
Fixture Flux	2700lm	3	2.08		618		
Efficacy	90lm/W	4	2.77		347		
936990	I _{max} =2059cd/klm	I _{max}	5559cd		5	3.46	222

PHOTOMETRICS

TL TRACK LIGHT

TD10S-4K8L-MSP-B



4000K	H(m)	D(m)	E _{max} (lx)
Ra80		31°	
Fixture Power	10W	1	0.55
Source Flux	900lm	2	1.10
Fixture Flux	900lm	3	1.64
Efficacy	90lm/W	4	2.19
861865	I _{max} =2482cd/klm	I _{max}	2234cd
		5	2.74
			89

TD22M-4K8L-FL-B



4000K	H(m)	D(m)	E _{max} (lx)
Ra80		46°	
Fixture Power	22W	1	0.84
Source Flux	2300lm	2	1.68
Fixture Flux	2300lm	3	2.52
Efficacy	105lm/W	4	3.36
861872	I _{max} =1444cd/klm	I _{max}	3320cd
		5	4.20
			133

TD15M-4K8L-FL-B



4000K	H(m)	D(m)	E _{max} (lx)
Ra80		44°	
Fixture Power	15W	1	0.80
Source Flux	1300lm	2	1.61
Fixture Flux	1300lm	3	2.41
Efficacy	87lm/W	4	3.21
851705	I _{max} =1528cd/klm	I _{max}	1986cd
		5	4.02
			79

TD38L-4K8L-FL-B



4000K	H(m)	D(m)	E _{max} (lx)
Ra80		44°	
Fixture Power	38W	1	0.80
Source Flux	4000lm	2	1.61
Fixture Flux	4000lm	3	2.41
Efficacy	105lm/W	4	3.21
861896	I _{max} =1528cd/klm	I _{max}	6111cd
		5	4.02
			244

SLIMFLUX NWB3

LP6060NWB3



4000K	H(m)	D(m)	E _{max} (lx)
Ra80		113°	
Fixture Power	40W	1	3.00
Source Flux	3607lm	2	6.01
Fixture Flux	3607lm	3	9.01
Efficacy	90lm/W	4	12.02
855567	I _{max} =342cd/klm	I _{max}	1234cd
		5	15.02
			49

LP6060NWB3- UGR



4000K	H(m)	D1(m)	D2(m)	E _{max} (lx)
Ra80		86°	89°	
Fixture Power	40W	1	1.87	1.98
Source Flux	3400lm	2	3.73	3.96
Fixture Flux	3400lm	3	5.60	5.94
Efficacy	85lm/W	4	7.46	7.92
862800	I _{max} =513cd/klm	I _{max}	1744cd	64
		5	9.33	9.90

SLIMFLUX NWB4

LP6060WNB4



3000K	H(m)	D(m)	E _{max} (lx)
Ra80		111°	
Fixture Power	40W	1	2.91
Source Flux	4000lm	2	5.83
Fixture Flux	4000lm	3	8.74
Efficacy	100lm/W	4	11.65
951290	I _{max} =352cd/klm	I _{max}	1410cd
		5	14.56
			56

LP6060NWB4-UGR



4000K	H(m)	D1(m)	D2(m)	E _{max} (lx)
Ra80		83°	90°	
Fixture Power	40W	1	1.78	2.01
Source Flux	3600lm	2	3.56	4.02
Fixture Flux	3600lm	3	5.34	6.02
Efficacy	90lm/W	4	7.13	8.03
951276	I _{max} =484cd/klm	I _{max}	1741cd	70
		5	8.91	10.04

SLIMFLUX IP65

LP6060NEX



4000K	H(m)	D(m)	E _{max} (lx)
Ra80		113°	
Fixture Power	36W	1	3.05
Source Flux	3300lm	2	6.09
Fixture Flux	3300lm	3	9.14
Efficacy	92lm/W	4	12.18
929442	I _{max} =348cd/klm	I _{max}	1147cd
		5	15.23
			46

SLIMFLUX

LP6060UGR-830A



3000K	H(m)	D1(m)	D2(m)	E _{max} (lx)
Ra80		87°	95°	
Fixture Power	37W	1	1.91	2.16
Source Flux	4010lm	2	3.82	4.33
Fixture Flux	4010lm	3	5.74	6.49
Efficacy	108lm/W	4	7.65	8.66
931810	I _{max} =507cd/klm	I _{max}	2032cd	73
		5	9.56	10.82

LP6060UGR-840A



4000K	H(m)	D1(m)	D2(m)	E _{max} (lx)
Ra80		87°	95°	
Fixture Power	37W	1	1.91	2.16
Source Flux	4350lm	2	3.82	4.33
Fixture Flux	4350lm	3	5.74	6.49
Efficacy	118lm/W	4	7.65	8.66
931735	I _{max} =507cd/klm	I _{max}	2205cd	80
		5	9.56	10.82

LP6060UGR-830D



3000K	H(m)	D1(m)	D2(m)	E _{max} (lx)
Ra80		87°	95°	
Fixture Power	37W	1	1.91	2.16
Source Flux	4010lm	2	3.82	4.33
Fixture Flux	4010lm	3	5.74	6.49
Efficacy	108lm/W	4	7.65	8.66
931810	I _{max} =507cd/klm	I _{max}	2032cd	73
		5	9.56	10.82

LP6060UGR-840D



4000K	H(m)	D1(m)	D2(m)	E _{max} (lx)
Ra80		87°	95°	
Fixture Power	37W	1	1.91	2.16
Source Flux	4350lm	2	3.82	4.33
Fixture Flux	4350lm	3	5.74	6.49
Efficacy	118lm/W	4	7.65	8.66
931766	I _{max} =507cd/klm	I _{max}	2205cd	80
		5	9.56	10.82

LP6060UGR-930A



4000K		H(m)	D1(m)	D2(m)	Emax(lx)		
Ra90			87°	95°			
Fixture Power	37W	1	1.91	2.16	1674		
Source Flux	3660lm	2	3.82	4.33	419		
Fixture Flux	3660lm	3	5.74	6.49	186		
Efficacy	99lm/W	4	7.65	8.66	105		
931773	I _{max} =507cd/klm	I _{max}	1855cd	5	9.56	10.82	67

LP6060UGR-930D



3000K		H(m)	D1(m)	D2(m)	Emax(lx)		
Ra90			87°	95°			
Fixture Power	37W	1	1.91	2.16	1409		
Source Flux	3080lm	2	3.82	4.33	352		
Fixture Flux	3080lm	3	5.74	6.49	157		
Efficacy	83lm/W	4	7.65	8.66	88		
931889	I _{max} =507cd/klm	I _{max}	1561cd	5	9.56	10.82	56

LP6060UGR-940A



4000K		H(m)	D1(m)	D2(m)	Emax(lx)		
Ra90			87°	95°			
Fixture Power	37W	1	1.91	2.16	1674		
Source Flux	3660lm	2	3.82	4.33	419		
Fixture Flux	3660lm	3	5.74	6.49	186		
Efficacy	99lm/W	4	7.65	8.66	105		
931773	I _{max} =507cd/klm	I _{max}	1855cd	5	9.56	10.82	67

LP6060UGR-940D



3000K		H(m)	D1(m)	D2(m)	Emax(lx)		
Ra90			87°	95°			
Fixture Power	37W	1	1.91	2.16	1409		
Source Flux	3080lm	2	3.82	4.33	352		
Fixture Flux	3080lm	3	5.74	6.49	157		
Efficacy	83lm/W	4	7.65	8.66	88		
931889	I _{max} =507cd/klm	I _{max}	1561cd	5	9.56	10.82	56

SLIMFLUX

LP6060P1UGR-840



4000K		H(m)	D1(m)	D2(m)	Emax(lx)		
Ra80			83°	90°			
Fixture Power	40W	1	1.78	2.01	1934		
Source Flux	4000lm	2	3.56	4.02	484		
Fixture Flux	4000lm	3	5.34	6.02	215		
Efficacy	100lm/W	4	7.13	8.03	121		
951221	I _{max} =484cd/klm	I _{max}	1934cd	5	8.91	10.04	77

SLIMFLUX

LP6060B1-860



6000K		H(m)	D(m)	Emax(lx)		
Ra80			111°			
Fixture Power	40W	1	2.91	1410		
Source Flux	4000lm	2	5.83	352		
Fixture Flux	4000lm	3	8.74	157		
Efficacy	100lm/W	4	11.65	88		
951184	I _{max} =352cd/klm	I _{max}	1410cd	5	14.56	56

LP6060B1UGR-840



4000K		H(m)	D1(m)	D2(m)	Emax(lx)		
Ra80			83°	90°			
Fixture Power	40W	1	1.78	2.01	1934		
Source Flux	4000lm	2	3.56	4.02	484		
Fixture Flux	4000lm	3	5.34	6.02	215		
Efficacy	100lm/W	4	7.13	8.03	121		
951153	I _{max} =484cd/klm	I _{max}	1934cd	5	8.91	10.04	77

SLIMFLUX

LP60120B1UGR-9CCT



4000K		H(m)	D(m)	Emax(lx)		
Ra90			94°			
Fixture Power	50W	1	2.16	2357		
Source Flux	5200lm	2	4.32	589		
Fixture Flux	5200lm	3	6.47	262		
Efficacy	104lm/W	4	8.63	147		
951344	I _{max} =453cd/klm	I _{max}	2358cd	5	10.79	94

LP6060B2UGR-8CCT



4000K		H(m)	D1(m)	D2(m)	Emax(lx)		
Ra80			80°	79°			
Fixture Power	40W	1	1.69	1.66	2970		
Source Flux	5400lm	2	3.38	3.32	742		
Fixture Flux	5400lm	3	5.07	4.98	330		
Efficacy	135lm/W	4	6.75	6.64	186		
LP6060B2UGR-8CCT	I _{max} =550cd/klm	I _{max}	2970cd	5	8.44	8.30	119

SLIMFLUX Q4

LP6060NWQ4



4000K		H(m)	D(m)	Emax(lx)		
			61°			
Fixture Power	35W	1	1.18	5006		
Source Flux	4500lm	2	2.36	1252		
Fixture Flux	4500lm	3	3.54	556		
Efficacy	129lm/W	4	4.72	313		
861957	I _{max} =1112cd/klm	I _{max}	5006cd	5	5.91	200

PHOTOMETRICS

SLIMFLUX VINTAGE

PV6060NW

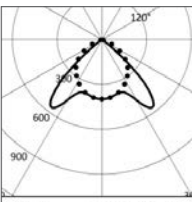

4000K	H(m)	D1(m)	D2(m)	Emax(lx)			
Ra80		94°	76°				
Fixture Power	38W	1	2.15	1.56	1430		
Source Flux	3600lm	2	4.30	3.11	358		
Fixture Flux	3600lm	3	6.45	4.67	159		
Efficacy	95lm/W	4	8.60	6.22	89		
855857	I _{max} =563cd/klm	I _{max}	2027cd	5	10.75	7.78	57

PV30120NW

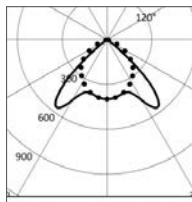

4000K	H(m)	D1(m)	D2(m)	Emax(lx)			
Ra80		94°	76°				
Fixture Power	33W	1	2.15	1.56	1311		
Source Flux	3300lm	2	4.30	3.11	328		
Fixture Flux	3300lm	3	6.45	4.67	146		
Efficacy	100lm/W	4	8.60	6.22	82		
855871	I _{max} =563cd/klm	I _{max}	1858cd	5	10.75	7.78	52

ROUND SLIMFLUX

LP60TWW

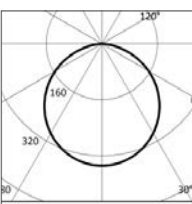

3000K	H(m)	D(m)	Emax(lx)			
Ra80		113°				
Fixture Power	35W	1	3.03	1042		
Source Flux	3000lm	2	6.06	261		
Fixture Flux	3000lm	3	9.09	116		
Efficacy	86lm/W	4	12.12	65		
850654	I _{max} =347cd/klm	I _{max}	1042cd	5	15.15	42

LP60TNW

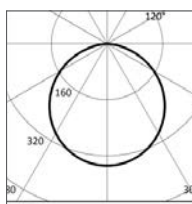

4000K	H(m)	D(m)	Emax(lx)			
Ra80		113°				
Fixture Power	35W	1	3.03	1042		
Source Flux	3000lm	2	6.06	261		
Fixture Flux	3000lm	3	9.09	116		
Efficacy	86lm/W	4	12.12	65		
850661	I _{max} =347cd/klm	I _{max}	1042cd	5	15.15	42

LP60TSPWW

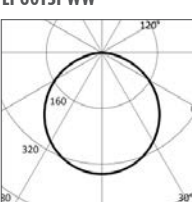

3000K	H(m)	D(m)	Emax(lx)			
Ra80		113°				
Fixture Power	35W	1	3.03	1042		
Source Flux	3000lm	2	6.06	261		
Fixture Flux	3000lm	3	9.09	116		
Efficacy	86lm/W	4	12.12	65		
850678	I _{max} =347cd/klm	I _{max}	1042cd	5	15.15	42

LP60TSPNW

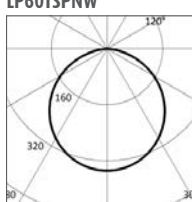

4000K	H(m)	D(m)	Emax(lx)			
Ra80		113°				
Fixture Power	35W	1	3.03	1042		
Source Flux	3000lm	2	6.06	261		
Fixture Flux	3000lm	3	9.09	116		
Efficacy	86lm/W	4	12.12	65		
850685	I _{max} =347cd/klm	I _{max}	1042cd	5	15.15	42

PLAFO T2

LC001W

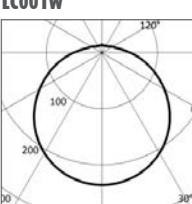

3000K	H(m)	D(m)	Emax(lx)			
Ra80		128°				
Fixture Power	20W	1	4.09	400		
Source Flux	1700lm	2	8.18	100		
Fixture Flux	1700lm	3	12.27	44		
Efficacy	85lm/W	4	16.35	25		
862688	I _{max} =235cd/klm	I _{max}	400cd	5	20.44	16

LC001

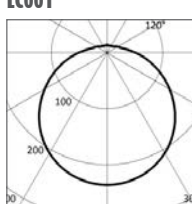

4000K	H(m)	D(m)	Emax(lx)			
Ra80		128°				
Fixture Power	20W	1	4.09	400		
Source Flux	1700lm	2	8.18	100		
Fixture Flux	1700lm	3	12.27	44		
Efficacy	85lm/W	4	16.35	25		
861162	I _{max} =235cd/klm	I _{max}	400cd	5	20.44	16

LC002W

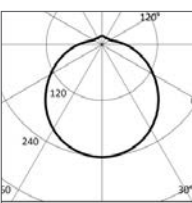

3000K	H(m)	D(m)	Emax(lx)			
Ra80		125°				
Fixture Power	30W	1	3.83	627		
Source Flux	2600lm	2	7.66	157		
Fixture Flux	2600lm	3	11.49	70		
Efficacy	87lm/W	4	15.32	39		
862695	I _{max} =241cd/klm	I _{max}	627cd	5	19.15	25

LC002

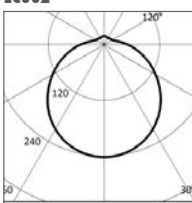

4000K	H(m)	D(m)	Emax(lx)			
Ra80		125°				
Fixture Power	30W	1	3.83	627		
Source Flux	2600lm	2	7.66	157		
Fixture Flux	2600lm	3	11.49	70		
Efficacy	87lm/W	4	15.32	39		
861179	I _{max} =241cd/klm	I _{max}	627cd	5	19.15	25

FILINO T5

LRT530WW

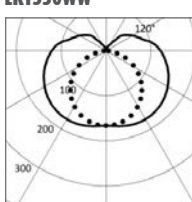

3000K	H(m)	D(m)	Emax(lx)
Ra80		100°	
Fixture Power	4W		
Source Flux	300lm		
Fixture Flux	300lm		
Efficacy	75lm/W		
936706	I _{max} =175cd/klm	I _{max}	53cd

LRT560NW

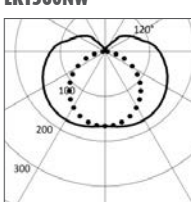

4000K	H(m)	D(m)	Emax(lx)
Ra80		100°	
Fixture Power	10W		
Source Flux	900lm		
Fixture Flux	900lm		
Efficacy	90lm/W		
861100	I _{max} =175cd/klm	I _{max}	158cd

LRT590WW

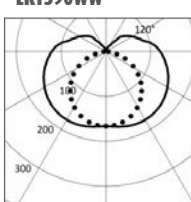

6000K	H(m)	D(m)	Emax(lx)
Ra80		100°	
Fixture Power	14W		
Source Flux	1310lm		
Fixture Flux	1310lm		
Efficacy	94lm/W		
936754	I _{max} =175cd/klm	I _{max}	229cd

LRT5120NW

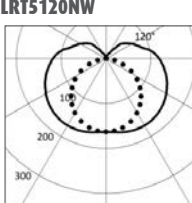

4000K	H(m)	D(m)	Emax(lx)
Ra80		100°	
Fixture Power	20W		
Source Flux	1900lm		
Fixture Flux	1859lm		
Efficacy	93lm/W		
861117	I _{max} =171cd/klm	I _{max}	326cd

LRT5150NW

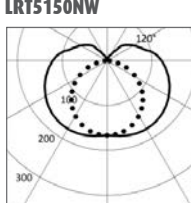

3000K	H(m)	D(m)	Emax(lx)
Ra80		100°	
Fixture Power	23W		
Source Flux	2050lm		
Fixture Flux	2050lm		
Efficacy	89lm/W		
936761	I _{max} =175cd/klm	I _{max}	359cd

PHOTOMETRICS

BATTEN BT3

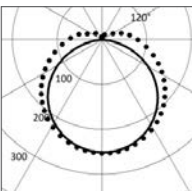
BT103C		6000K		H(m)	D1(m)	D2(m)	E _{max} (lx)
		Ra80		115° 140°			
Fixture Power	40W	1	3.17	5.51	1159		
Source Flux	4560lm	2	6.34	11.03	290		
Fixture Flux	4560lm	3	9.51	16.54	129		
Efficacy	114lm/W	4	12.67	22.05	72		
941123	I _{max} =255cd/klm	I _{max}	1162cd	5	15.84	27.56	46

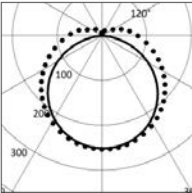
BT103W		3000K		H(m)	D1(m)	D2(m)	E _{max} (lx)
		Ra80		115° 140°			
Fixture Power	40W	1	3.17	5.51	1058		
Source Flux	4160lm	2	6.34	11.03	264		
Fixture Flux	4160lm	3	9.51	16.54	118		
Efficacy	104lm/W	4	12.67	22.05	66		
941130	I _{max} =255cd/klm	I _{max}	1060cd	5	15.84	27.56	42

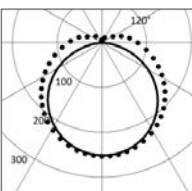
BT104N		4000K		H(m)	D1(m)	D2(m)	E _{max} (lx)
		Ra80		115° 140°			
Fixture Power	50W	1	3.17	5.51	1398		
Source Flux	5500lm	2	6.34	11.03	350		
Fixture Flux	5500lm	3	9.51	16.54	155		
Efficacy	110lm/W	4	12.67	22.05	87		
941147	I _{max} =255cd/klm	I _{max}	1401cd	5	15.84	27.56	56

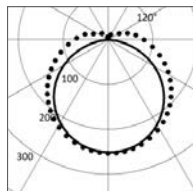
BT103N		4000K		H(m)	D1(m)	D2(m)	E _{max} (lx)
		Ra80		115° 140°			
Fixture Power	40W	1	3.17	5.51	1119		
Source Flux	4400lm	2	6.34	11.03	280		
Fixture Flux	4400lm	3	9.51	16.54	124		
Efficacy	110lm/W	4	12.67	22.05	70		
941116	I _{max} =255cd/klm	I _{max}	1121cd	5	15.84	27.56	45

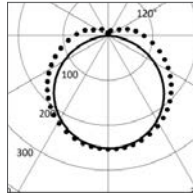
BT104C		6000K		H(m)	D1(m)	D2(m)	E _{max} (lx)
		Ra80		115° 140°			
Fixture Power	50W	1	3.17	5.51	1449		
Source Flux	5700lm	2	6.34	11.03	362		
Fixture Flux	5700lm	3	9.51	16.54	161		
Efficacy	114lm/W	4	12.67	22.05	91		
941154	I _{max} =255cd/klm	I _{max}	1452cd	5	15.84	27.56	58

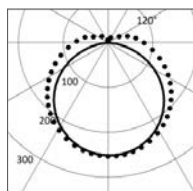
BT104W		3000K		H(m)	D1(m)	D2(m)	E _{max} (lx)
		Ra80		115° 140°			
Fixture Power	50W	1	3.17	5.51	1322		
Source Flux	5200lm	2	6.34	11.03	331		
Fixture Flux	5200lm	3	9.51	16.54	147		
Efficacy	104lm/W	4	12.67	22.05	83		
941161	I _{max} =255cd/klm	I _{max}	1325cd	5	15.84	27.56	53

HIGH BAY - HB3

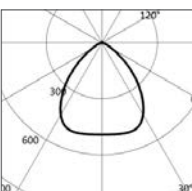
HB3-100		4000K		H(m)	D(m)	E _{max} (lx)
		Ra80		89°		
Fixture Power	100W	1	1.96	4907		
Source Flux	10000lm	2	3.92	1227		
Fixture Flux	10000lm	3	5.89	545		
Efficacy	100lm/W	4	7.85	307		
HB3-100	I _{max} =500cd/klm	I _{max}	4997cd	5	9.81	196

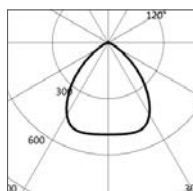
HB3-150		4000K		H(m)	D(m)	E _{max} (lx)
		Ra80		89°		
Fixture Power	150W	1	1.96	7361		
Source Flux	15000lm	2	3.92	1840		
Fixture Flux	15000lm	3	5.89	818		
Efficacy	100lm/W	4	7.85	460		
HB3-150	I _{max} =500cd/klm	I _{max}	7495cd	5	9.81	294

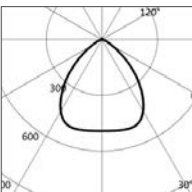
HB3-200		4000K		H(m)	D(m)	E _{max} (lx)
		Ra80		89°		
Fixture Power	200W	1	1.96	9814		
Source Flux	20000lm	2	3.92	2454		
Fixture Flux	20000lm	3	5.89	1090		
Efficacy	100lm/W	4	7.85	613		
HB3-200	I _{max} =500cd/klm	I _{max}	9993cd	5	9.81	393

HBL BEATRIX

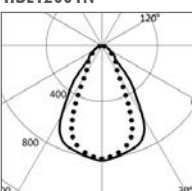
HBL12001N		4000K		H(m)	D1(m)	D2(m)	E _{max} (lx)
		Ra80		70° 51°			
Fixture Power	80W	1	1.40	0.95	5930		
Source Flux	7200lm	2	2.81	1.90	1483		
Fixture Flux	7200lm	3	4.21	2.85	659		
Efficacy	90lm/W	4	5.61	3.80	371		
941338	I _{max} =824cd/klm	I _{max}	5930cd	5	7.02	4.75	237

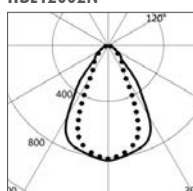
HBL12002N		4000K		H(m)	D1(m)	D2(m)	E _{max} (lx)
		Ra80		70° 51°			
Fixture Power	80W	1	1.40	0.95	5930		
Source Flux	7200lm	2	2.81	1.90	1483		
Fixture Flux	7200lm	3	4.21	2.85	659		
Efficacy	90lm/W	4	5.61	3.80	371		
941352	I _{max} =824cd/klm	I _{max}	5930cd	5	7.02	4.75	237

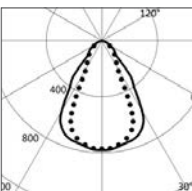
HBL6001N		4000K		H(m)	D1(m)	D2(m)	E _{max} (lx)
		Ra80		71° 51°			
Fixture Power	40W	1	1.43	0.96	2804		
Source Flux	3600lm	2	2.86	1.93	701		
Fixture Flux	3600lm	3	4.29	2.89	312		
Efficacy	90lm/W	4	5.72	3.85	175		
941321	I _{max} =780cd/klm	I _{max}	2808cd	5	7.15	4.81	112

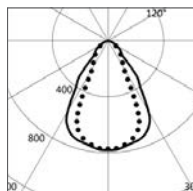
HBL6002N		4000K		H(m)	D1(m)	D2(m)	E _{max} (lx)
		Ra80		71° 51°			
Fixture Power	40W	1	1.43	0.96	2804		
Source Flux	3600lm	2	2.86	1.93	701		
Fixture Flux	3600lm	3	4.29	2.89	312		
Efficacy	90lm/W	4	5.72	3.85	175		
941345	I _{max} =780cd/klm	I _{max}	2808cd	5	7.15	4.81	112

PANTH SLZ

PANTH-SL1002

	4000K	H(m)	D1(m)	D2(m)	E _{max} (lx)		
	Ra80		104°	69°			
	Fixture Power	100W	1	2.56	1.37	5325	
	Source Flux	11000lm	2	5.13	2.73	1331	
	Fixture Flux	11000lm	3	7.69	4.10	592	
	Efficacy	110lm/W	4	10.26	5.47	333	
	861810	I _{max} =484cd/klm	I _{max}	5325cd	5	12.82	6.83

PANTH-SL2002

	4000K	H(m)	D1(m)	D2(m)	E _{max} (lx)		
	Ra80		101°	58°			
	Fixture Power	200W	1	2.42	1.12	10184	
	Source Flux	20000lm	2	4.85	2.23	2546	
	Fixture Flux	20000lm	3	7.27	3.35	1132	
	Efficacy	100lm/W	4	9.70	4.47	636	
	861858	I _{max} =509cd/klm	I _{max}	10184cd	5	12.12	5.58

HIGH BAY HB2

HB2-100

	4000K	H(m)	D(m)	E _{max} (lx)		
	Ra80		81°			
	Fixture Power	100W	1	1.70	7283	
	Source Flux	13000lm	2	3.40	1821	
	Fixture Flux	13000lm	3	5.10	809	
	Efficacy	130lm/W	4	6.80	455	
	929459	I _{max} =560cd/klm	I _{max}	7283cd	5	8.49

PANTH-SL1502

	4000K	H(m)	D1(m)	D2(m)	E _{max} (lx)		
	Ra80		103°	57°			
	Fixture Power	150W	1	2.53	1.09	6769	
	Source Flux	13500lm	2	5.05	2.18	1692	
	Fixture Flux	13500lm	3	7.58	3.26	752	
	Efficacy	90lm/W	4	10.10	4.35	423	
	861841	I _{max} =501cd/klm	I _{max}	6769cd	5	12.63	5.44

HB2-200

	4000K	H(m)	D(m)	E _{max} (lx)		
	Ra80		112°			
	Fixture Power	200W	1	2.95	9373	
	Source Flux	26000lm	2	5.90	2343	
	Fixture Flux	26000lm	3	8.85	1041	
	Efficacy	130lm/W	4	11.80	586	
	929893	I _{max} =361cd/klm	I _{max}	9373cd	5	14.75

PANTH ST

PANTH-ST20N

	4000K	H(m)	D1(m)	D2(m)	E _{max} (lx)		
	Ra80		108°	96°			
	Fixture Power	20W	1	2.74	2.22	671	
	Source Flux	1560lm	2	5.48	4.43	168	
	Fixture Flux	1560lm	3	8.23	6.65	75	
	Efficacy	78lm/W	4	10.97	8.86	42	
	932305	I _{max} =431cd/klm	I _{max}	672cd	5	13.71	11.08

PANTH-ST30N

	4000K	H(m)	D1(m)	D2(m)	E _{max} (lx)		
	Ra80		116°	110°			
	Fixture Power	30W	1	3.21	2.88	897	
	Source Flux	2450lm	2	6.41	5.75	224	
	Fixture Flux	2450lm	3	9.62	8.63	100	
	Efficacy	82lm/W	4	12.82	11.51	56	
	932312	I _{max} =367cd/klm	I _{max}	898cd	5	16.03	14.39

PANTH-ST10N

	4000K	H(m)	D1(m)	D2(m)	E _{max} (lx)		
	Ra80		95°	75°			
	Fixture Power	10W	1	2.17	1.55	384	
	Source Flux	750lm	2	4.35	3.09	96	
	Fixture Flux	750lm	3	6.52	4.64	43	
	Efficacy	75lm/W	4	8.70	6.18	24	
	932299	I _{max} =512cd/klm	I _{max}	384cd	5	10.87	7.73

PANTH-ST50N

	4000K	H(m)	D1(m)	D2(m)	E _{max} (lx)		
	Ra80		116°	114°			
	Fixture Power	50W	1	3.18	3.08	1498	
	Source Flux	4000lm	2	6.36	6.16	375	
	Fixture Flux	4185lm	3	9.54	9.24	166	
	Efficacy	84lm/W	4	12.72	12.31	94	
	932329	I _{max} =375cd/klm	I _{max}	1499cd	5	15.89	15.39

PANTH ST HP

PANTH-ST100N

	4000K	H(m)	D(m)	E _{max} (lx)		
	Ra80		110°			
	Fixture Power	100W	1	2.88	3303	
	Source Flux	9000lm	2	5.76	826	
	Fixture Flux	9000lm	3	8.64	367	
	Efficacy	90lm/W	4	11.52	206	
	941031	I _{max} =368cd/klm	I _{max}	3312cd	5	14.40

PANTH-ST150N

	4000K	H(m)	D(m)	E _{max} (lx)		
	Ra80		113°			
	Fixture Power	150W	1	3.03	5099	
	Source Flux	14000lm	2	6.05	1275	
	Fixture Flux	14000lm	3	9.08	567	
	Efficacy	93lm/W	4	12.10	319	
	941062	I _{max} =364cd/klm	I _{max}	5102cd	5	15.13

PANTH-ST250N

	4000K	H(m)	D(m)	E _{max} (lx)		
	Ra80		114°			
	Fixture Power	250W	1	3.06	8770	
	Source Flux	24000lm	2	6.12	2192	
	Fixture Flux	24000lm	3	9.19	974	
	Efficacy	96lm/W	4	12.25	548	
	941093	I _{max} =366cd/klm	I _{max}	8784cd	5	15.31

PANTH EVO

PANTH-WH10N

	4000K	H(m)	D1(m)	D2(m)	E _{max} (lx)		
	Ra80		122°	111°			
	Fixture Power	10W	1	3.62	2.89	302	
	Source Flux	900lm	2	7.24	5.79	75	
	Fixture Flux	900lm	3	10.86	8.68	34	
	Efficacy	90lm/W	4	14.48	11.57	19	
	855482	I _{max} =336cd/klm	I _{max}	302cd	5	18.09	14.47

PANTH-WH30N

	4000K	H(m)	D(m)	E _{max} (lx)		
	Ra80		111°			
	Fixture Power	30W	1	2.90	929	
	Source Flux	2650lm	2	5.80	232	
	Fixture Flux	2650lm	3	8.70	103	
	Efficacy	88lm/W	4	11.60	58	
	855529	I _{max} =351cd/klm	I _{max}	929cd	5	14.50

JAZZ

JZ03BWW

	3000K	H(m)	D1(m)	D2(m)	E _{max} (lx)		
	Ra80		60°	59°			
	Fixture Power	30W	1	1.15	1.14	3237	
	Source Flux	2812lm	2	2.31	2.29	809	
	Fixture Flux	2812lm	3	3.46	3.43	360	
	Efficacy	94lm/W	4	4.61	4.57	202	
	JZ03BWW	I _{max} =1151cd/klm	I _{max}	3237cd	5	5.76	5.72

RTF WALSPOM

LND0760NW

	4000K	H(m)	D(m)	E _{max} (lx)		
	Ra80		56°			
	Fixture Power	7W	1	1.07	431	
	Source Flux	430lm	2	2.15	108	
	Fixture Flux	430lm	3	3.22	48	
	Efficacy	61lm/W	4	4.29	27	
	850562	I _{max} =1043cd/klm	I _{max}	449cd	5	5.37

DU404530

	3000K	H(m)	D(m)	E _{max} (lx)		
	Ra80		53°			
	Fixture Power	7W	1	1.00	489	
	Source Flux	430lm	2	2.00	122	
	Fixture Flux	430lm	3	3.00	54	
	Efficacy	61lm/W	4	3.99	31	
	839666	I _{max} =1136cd/klm	I _{max}	489cd	5	4.99

DU402030

	3000K	H(m)	D(m)	E _{max} (lx)		
	Ra80		33°			
	Fixture Power	20W	1	0.60	3903	
	Source Flux	1600lm	2	1.20	976	
	Fixture Flux	1600lm	3	1.80	434	
	Efficacy	80lm/W	4	2.40	244	
	843892	I _{max} =2439cd/klm	I _{max}	3903cd	5	3.00

PANTH-WH20N

	4000K	H(m)	D(m)	E _{max} (lx)		
	Ra80		111°			
	Fixture Power	20W	1	2.92	682	
	Source Flux	1850lm	2	5.84	171	
	Fixture Flux	1850lm	3	8.76	76	
	Efficacy	93lm/W	4	11.68	43	
	855505	I _{max} =369cd/klm	I _{max}	682cd	5	14.60

PANTH-WH50N

	4000K	H(m)	D(m)	E _{max} (lx)		
	Ra80		111°			
	Fixture Power	50W	1	2.89	1657	
	Source Flux	4500lm	2	5.77	414	
	Fixture Flux	4500lm	3	8.66	184	
	Efficacy	90lm/W	4	11.55	104	
	855543	I _{max} =368cd/klm	I _{max}	1657cd	5	14.43

JZ03BN

	4000K	H(m)	D(m)	E _{max} (lx)		
	Ra80		57°			
	Fixture Power	30W	1	1.10	4157	
	Source Flux	3500lm	2	2.19	1039	
	Fixture Flux	3500lm	3	3.29	462	
	Efficacy	117lm/W	4	4.39	260	
	862442	I _{max} =1188cd/klm	I _{max}	4157cd	5	5.48

12PR0615CW

	6000K	H(m)	D(m)	E _{max} (lx)		
	Ra80		28°			
	Fixture Power	6W	1	0.50	887	
	Source Flux	400lm	2	0.99	222	
	Fixture Flux	400lm	3	1.49	99	
	Efficacy	67lm/W	4	1.98	55	
	850579	I _{max} =2219cd/klm	I _{max}	887cd	5	2.48

DU401430

	3000K	H(m)	D(m)	E _{max} (lx)		
	Ra80		53°			
	Fixture Power	14W	1	1.00	1129	
	Source Flux	1000lm	2	2.00	282	
	Fixture Flux	994lm	3	3.00	125	
	Efficacy	71lm/W	4	3.99	71	
	843885	I _{max} =1129cd/klm	I _{max}	1129cd	5	4.99

PROJECTORS SUBAQ

INDEX

12PR0615CW	155	BH08TN-W	163	D83040A	35	DU401430	157	KTLPW1-MS	103
12PR1530RGB	155	BH12TN-W	163	D83040HPT	33	DU402030	157	KTLRT	115
12PR1860RGB	155	BH16EN-B	163	D83060A	35	DU404530	157	KTLRT-CORD	115
1T2220	66-71-73-77	BH20	161	DELTA20A-12	169	FASTCON-30	103-170	KTMNLBKT15	148
1T2221	66-71-73-77	BH20LL	161	DELTA40C-M	169	HB2-100	133	KTMNLBKT30	148
9000-1/B-R	74	BH015	161	DELTA40D-M	169	HB2-100DALI	133	KTMNLBKT45	148
9000-1/B-ST	74	BH015LL	161	DELTA50A-12	169	HB2-150	133	KTMNLBKTVERT	148
9000-1/W-R	74	BT103C	119	DELTA65D-M	169	HB2-150DALI	133	KTQ8SL2	42
9000-1/W-ST	74	BT103N	119	DH25L130	51	HB2-200	133	KTQSL2	42
9000-2/B-R	74	BT103W	119	DH25L140	51	HB2-200DALI	133	KTT8SL2	42
9000-2/B-ST	74	BT104C	119	DH30L130EX	49	HB3-100	127	KTTB50ACO1-B	66
9000-2/W-R	74	BT104N	119	DH30L140EX	49	HB3-150	127	KTTB50ACO1-W	66
9000-2/W-ST	74	BT104W	119	DH30L2EXCCT	47	HB3-200	127	KTTB50ACO-B	66
9000-3/B-R	74	D3030HPQ-D	33	DH40L130	51	HBL12001N	129	KTTB50ACO-W	66
9000-3/B-ST	74	D3040HPQ	33	DH40L130EX	49	HBL12002N	129	KTTB50AGL1-B	66
9000-3/W-R	74	D306TNW	54	DH40L140	51	HBL6001N	129	KTTB50AGL1-W	66
9000-3/W-ST	74	D306TWW	54	DH40L140EX	49	HBL6002N	129	KTTB50AGL-B	66
9001/B	75	D30730	31	DH40L2EXCCT	47	JZ03BNW	151	KTTB50AGL-W	66
9001/W	75	D30740	31	DH60L130	51	JZ03BWW	151	KTTB60ACO1-B	66
9002/B	75	D30760	31	DH60L140	51	KTBH15ARB	162	KTTB60ACO1-W	66
9002/W	75	D307QNW	55	DH80L130	51	KTBH15GRB	162	KTTB60ACO-B	66
9003/B	76	D307QWW	55	DH80L130EX	49	KTBH15GRW	162	KTTB60ACO-W	66
9003/W	76	D307TNW	55	DH80L140	51	KTBH20ARB	162	KTTB60AGL1-B	66
9004/B	74	D307TWW	55	DH80L140EX	49	KTBH20GRB	162	KTTB60AGL1-W	66
9004/W	74	D407830	45	DH80L2EXCCT	47	KTBH20GRW	162	KTTB60AGL-B	66
9004-R/B	74	D407840	45	DS04L130Q	39	KTBH20HMB	162	KTTB60AGL-W	66
9004-R/W	74	D41530	31	DS04L130T	39	KTBH20HMW	162	KTTB60LENS	66
9010/B	75	D41530A	35	DS04L140Q	39	KT-BHL-SP	129	KTTB80ACO1-B	66
9010/W	75	D41540	31	DS04L140T	39	KT-BT1-FS	119	KTTB80ACO1-W	66
9011/B	76	D41540A	35	DS04L160Q	39	KTEMRO3	170	KTTB80ACO-B	66
9011/W	76	D41540QSL2	41	DS04L160T	39	KTHB2-100-F	133	KTTB80ACO-W	66
9012/B	76	D41540SL2	41	DS08L130Q	39	KTHB2-100-PCR	133	KTTB80AGL1-B	66
9012/W	76	D41560	31	DS08L130T	39	KTHB2-100-R	133	KTTB80AGL1-W	66
9013/B	76	D41560A	35	DS08L140Q	39	KTHB2-200-F	133	KTTB80AGL-B	66
9013/W	76	D815830	45	DS08L140T	39	KTHB2-200-PCR	133	KTTB80AGL-W	66
9014/B	76	D815840	45	DS08L160Q	39	KTHB2-200-R	133	KTTB80LENS	66
9014/W	76	D82530	31	DS08L160T	39	KTHB3-100-G	127	KTTSL2	42
9015/B	76	D82530A	35	DS10L130Q	39	KTHB3-100-PCR	127	LC001	112
9015/W	76	D82540	31	DS10L130T	39	KTHB3-100-R60	127	LC001-MW	112
9016/B	76	D82540A	35	DS10L140Q	39	KTHB3-200-G	127	LC001W	112
9016/W	76	D82540QSL2	41	DS10L140T	39	KTHB3-200-PCR	127	LC002	112
9017/B	76	D82540SL2	41	DS10L160Q	39	KTHB3-200-R60	127	LC002W	112
9017/W	76	D82560	31	DS10L160T	39	KTLPQ4-MS	97	LND0760NW	152
9018/B	76	D82560A	35	DT40L1CCT	29	KTLPQ4-SM	97	LP30120B1-840	93
9018/W	76	D83030A	35	DT80L1CCT	29	KTLPQ4-SP	97	LP30120B1UGR-9CCT	94
BH08EN-B	163	D83030HPT-D	33	DT80L1CCTHP	29	KTLP-SPU	86-87-88-91	LP30120DE-TR	109

LP30120DEW-TR	109	LP60TWW	107	PANTH-ST100W	139	S-9000/T	77	TD22M-4K8L-FL-W	70
LP30120NWB3	86	LP6262UGR-830A	90	PANTH-ST10C	137	S-9000KIT	75	TD38L-3K8L-FL-B	70
LP30120P1-840	92	LP6262UGR-830D	91	PANTH-ST10N	137	S-9001/115-B	75	TD38L-3K8L-FL-W	70
LP30120UGR-840A	90	LP6262UGR-840A	90	PANTH-ST10W	137	S-9001/115-W	75	TD38L-4K8L-FL-B	70
LP30120UGR-840D	91	LP6262UGR-840D	91	PANTH-ST150C	139	S-9001-R/6-B	77	TD38L-4K8L-FL-W	70
LP30120UGR-940A	90	LP6262UGR-930A	90	PANTH-ST150N	139	S-9001-R/6-W	77	TDL-ACO	71
LP30120UGR-940D	91	LP6262UGR-930D	91	PANTH-ST150W	139	S-9010-R/6-B	77	TDL-AGL	71
LP60120B1-840	93	LP6262UGR-940A	90	PANTH-ST20C	137	S-9010-R/6-W	77	TDL-BDF	71
LP60120B1UGR-9CCT	94	LP6262UGR-940D	91	PANTH-ST20N	137	S-9011-R/6-B	77	TDL-LENS24	71
LP60120P1-840	92	LPLAF0120	102	PANTH-ST20W	137	S-9011-R/6-W	77	TDL-LENS60	71
LP6060B1-830	93	LPLAF01203	102	PANTH-ST250C	139	S-9013-R/6-B	77	TDM-ACO	71
LP6060B1-840	93	LPLAF060	102	PANTH-ST250N	139	S-9013-R/6-W	77	TDM-AGL	71
LP6060B1-860	93	LPLAF0603	102	PANTH-ST250W	139	S-9017-R/6-B	77	TDM-BDF	71
LP6060B1UGR-840	93	LP-SSK	103-170	PANTH-ST30C	137	S-9017-R/6-W	77	TDM-LENS24	71
LP6060B1UGR-8CCT	94	LRT5120CW	115	PANTH-ST30N	137	SP01-W	73	TDM-LENS60	71
LP6060B1UGR-930	93	LRT5120NW	115	PANTH-ST30W	137	SW001N	164	W1SQ30-W	53
LP6060B1UGR-940	93	LRT5120WW	115	PANTH-ST50C	137	SW001W	164	W1SQ30-W	53
LP6060B1UGR-9CCT	94	LRT5150CW	115	PANTH-ST50N	137	SW002N	164	ZK001	59
LP6060B2-840	93	LRT5150NW	115	PANTH-ST50W	137	SW002W	164	ZK002	59
LP6060B2UGR-8CCT	94	LRT5150WW	115	PANTH-WH10N	141	SW003N	164	ZK003	59
LP6060CWB3	86	LRT530CW	115	PANTH-WH10W	141	SW003W	164	ZK004	59
LP6060CWB4	87	LRT530NW	115	PANTH-WH20N	141	T010	61	ZKLP10-M	169
LP6060NEX	88	LRT530WW	115	PANTH-WH20W	141	T053	61	ZKR2-ST	58
LP6060NWB3	86	LRT560CW	115	PANTH-WH30N	141	TB50L130-B	65	ZKR65QB	60
LP6060NWB3-UGR	86	LRT560NW	115	PANTH-WH30W	141	TB50L130-W	65	ZKR65QG	60
LP6060NWB4	87	LRT560WW	115	PANTH-WH50N	141	TB50L140-B	65	ZKR65TB	60
LP6060NWB4-UGR	87	LRT590CW	115	PANTH-WH50W	141	TB50L140-W	65	ZKR65TG	60
LP6060NWQ4	97	LRT590NW	115	PLAFOW1SQ-W	53	TB60L130-B	65	ZKRQB	60
LP6060P1-840	92	LRT590WW	115	PV30120NW	99	TB60L130-W	65	ZKRQG	60
LP6060P1UGR-840	92	MNLO16EP12FLO30E	148	PV30120UGR-940	99	TB60L140-B	65	ZKRR	59
LP6060P2-860	92	MNLO16EP12FLO40E	148	PV30120UGR-940D	99	TB60L140-W	65	ZKRTB	60
LP6060UGR-830A	90	MNLO32EP24FLO30E	148	PV6060NW	99	TB80L130-B	65	ZKRTB2	61
LP6060UGR-830D	91	MNLO32EP24FLO40E	148	PV6060UGR-940	99	TB80L130-W	65	ZKRTG	60
LP6060UGR-840A	90	ORDEV1	148	PV6060UGR-940D	99	TB80L140-B	65	ZW01N-B	166
LP6060UGR-840D	91	ORDEV2	148	S1L102C	121	TB80L140-W	65	ZW01N-G	166
LP6060UGR-930A	90	PANTH-B10N	141	S1L102N	121	TD10S-3K8L-MSP-B	70	ZW01N-W	166
LP6060UGR-930D	91	PANTH-B20N	141	S1L202C	121	TD10S-3K8L-MSP-W	70	ZW01W-B	166
LP6060UGR-940A	90	PANTH-B30N	141	S1L202N	121	TD10S-4K8L-MSP-B	70	ZW01W-G	166
LP6060UGR-940D	91	PANTH-B30NS	143	S2T101N	123	TD10S-4K8L-MSP-W	70	ZW01W-W	166
LP6060WWB3	86	PANTH-B50N	141	S2T102N	123	TD15M-3K8L-FL-B	70		
LP6060WWB4	87	PANTH-B50NS	143	S2T201N	123	TD15M-3K8L-FL-W	70		
LP60TNNW	107	PANTH-SL1002	131	S2T202N	123	TD15M-4K8L-FL-B	70		
LP60TSPDENW	107	PANTH-SL1502	131	S-9000/111	75	TD15M-4K8L-FL-W	70		
LP60TSPDEWW	107	PANTH-SL2002	131	S-9000/123	77	TD22M-3K8L-FL-B	70		
LP60TSPNW	107	PANTH-ST100C	139	S-9000/M-B-KIT	77	TD22M-3K8L-FL-W	70		
LP60TSPWW	107	PANTH-ST100N	139	S-9000/M-W-KIT	77	TD22M-4K8L-FL-B	70		

TARGETTI SANKEY S.p.A.
Via Pratese, 164
50145 Firenze - Italia
Phone 055 3791.1
Fax 055 3791.266
targetti@targetti.com
www.targetti.com

Customer Care
customer@targetti.com

Customer Service
technical@targetti.com

Lighting Consulting
project@targetti.com

DURALAMP
Via Pratese, 164
50145 Firenze - Italia
Phone 055 894 881
Fax 055 8953 032 /
055 8952 780
duralamp@duralamp.it
www.duralamp.de

Customer Care
customer@duralamp.it

Customer Service
technical@duralamp.it

Lighting Consulting
project@duralamp.it

Subsidiaries

China
TARGETTI LIGHTING (BEIJING) CO. LTD
Room 1206 Building B Winterless Center, No.1 West
Da Wang Road, Chaoyang District
Beijing 100026
+86 10 65388956
teresa.yan@targetti.cn

France
TARGETTI FRANCE S.A.S.
2, rue de la Renaissance
92160, Antony
France
Tél: +33 (0)1.44.29.09.09
Fax: +33 (0)1.44.29.09.08
targetti.fr@targetti.com

India
TARGETTI INDIA
Teamwork building, 2nd floor
No. 18 Chinnaswamy Mudaliar Road Tasker Town
560051, Bangalore
Tel: +91 80 41120016
Mob: +91 81 36811144
s.karthik@targetti.com

Italy (Headquarters)
TARGETTI SANKEY S.P.A.
Via Pratese, 164
Firenze 50145
+39 055 37911
Fax +39 055 3791266
targetti@targetti.com

Commercial network

ALBANIA
EUROSISTEM ALBANIA SH.P.K.
Autostrada Tërana - Durazzo Km 0 Albania
Ph: +355 672010020
info@eurossistemalbania.al

SIAME SH.P.K
Peze Helmes - Tirane Tirane Albania
Ph: +355 48620020
info@siame-al.com
www.siame-al.com

DENMARK
DURALAMP Danmark A/S
Gejlhavegård 5, 6000 Kolding, DK Danimarca
Ph: +45 70 251545
dura@duralys.dk
www.duralamp.dk

GERMANY
3F Filippi GmbH
Dornierstraße 15
82205 Gilching - Deutschland
Ph: +49 8105 730 46-0
Fax +49 8105 730 46-29
info@3F-Filippi.de

GREECE
Maretsikos Lighting LTD.
34 Eynardou Str. 10440 Athens Grecia
Ph: +30 210 8822209
maretsik@otenet.gr
www.mlighting.gr

HUNGARY
Hunilux Kft.
H-1097 Budapest, Vaskapu utca 43-45. Ungheria
Ph: +36 1 218 2285 Fax: +36 1 218 2279
hunilux@hunilux.hu
www.hunilux.hu

Spain
TARGETTI SPAIN S.A.U
Avda. de Roma, n°69,
Barcelona 08029
+34 93 474 61 71
targetti.es@targetti.com

U.A.E.
TARGETTI SANKEY S.P.A. (BRANCH)
Dubai Airport Free Zone Authority - Bldg.
6 West A - Office 731
Dubai P.O. Box 54744
+9714 6091033
jcoll@targetti.com

UK
TARGETTI UK LIMITED
288 Bishopsgate
London EC2M 4QP
+44 (0) 203 709 4065
m.allen@targetti.com

U.S.A.
TARGETTI USA INC.
750-A West 17th Street
Costa Mesa, CA 92626
+1 714 513 1991
targetti.usa@targetti.com

Latin America
TARGETTI LATIN AMERICA
Cra 2 Oeste # 5-262,
Edificio Av. Belalcazar, Apt. 901
Cali, Colombia
+57 3128 317174
l.valdrighi@targetti.com

JORDAN
ART LIGHT
P.O.Box 926831
Amman 11190 - Jordan
Ph: +962 6 5344796
Fax.: +962 6 5344798
a.bakri@lightwl.com

MALTA
ELEKTRA LIMITED
Mill Street - Qormi 3100, Malta
Ph: +356 25463000
info@elektra.com.mt

RUSSIA
MOSCOW OFFICE
Dubininskaya str.57 bld. 2, office 8
115054, Moscow - Russia
Ph: +7 926 5233003
j.bigazzi@targetti.com

SAINT-PETERSBURG OFFICE
Novoroshinkaya Street, 4,
BC Sobranie, Office 405
Saint-Petersburg - Russia
Ph: +7 812 611 02 10
n.guskova@targetti.com

SWITZERLAND
3F-Filippi Schweiz GmbH
Russmatten 32
4624 Härkingen
Ph: +41 62 390 00 44
info@3f-filippi.ch

TUNISIA
ELECTRO PLUS - Sabeur DRISS
11, Bis Rue El Bohtori 2080 Ariana Tunisia
Tel: +216 71 711 964
GSM: +216 50 426 629
Email: electropus@planet.tn

GENERAL SALES CONDITIONS

1. Applicability

1.1 These general conditions (hereafter the "Conditions") constitute an integral and essential part of the contract of sale between the Parties. The Conditions shall regulate all legal relationships between Duralamp S.p.A. (hereafter "Duralamp") and the purchaser (hereafter the "Purchaser") where the said relationships are not disciplined by the applicable terms of the Italian Civil Code (C.C.). The nullity of any of the terms of these Conditions shall not prejudice the validity of the remaining Conditions or the Contract.

1.2 Any changes to these Conditions shall be agreed between the Parties in writing, with the exception of the provisions set down in article 1341 of the Italian C.C..

2. Sales

2.1 Sale requests for the products (hereafter the "Products") shall be accepted 'subject to the seller's approval' and shall be considered to be irrevocable in accordance with and as an effect of article 1329 of the C.C. for a period of 1 (one) month from the date of the order requesting execution without prior acknowledgement, pursuant to and as an effect of article 1327 of the C.C. from the date on which the order is received by Duralamp.

2.2 The Products detailed in the individual orders and the relevant accessories shall be supplied to the Purchaser by Duralamp with "Retention of Title" pursuant to and as an effect of articles 1523-1526 of the Italian C.C. In this case, the transfer of ownership of the Products to the Purchaser shall take place exclusively upon the full payment of the price agreed, whilst any risks shall be the responsibility of the Purchaser from the moment of delivery of the Products.

2.3 Whilst confirming the terms stated above, the Parties hereby agree that should the Products and relevant accessories be destroyed for causes not attributable to Duralamp, the Purchaser shall not be released from the obligation to pay for the same, even where the Products have not yet been delivered.

3. Prices

3.1 The prices detailed on the price list shall be applied to Product sales orders. The aforementioned prices shall be unit prices per single item, except where stated otherwise for certain Products. The Parties shall have the right to agree, in writing, any derogations and/or special conditions of sale.

3.2 Moreover, the Parties hereby agree that the following conditions shall be applied:
(I) Minimum order: € 300 (three hundred) for Italy - € 750 (seven hundred and fifty) for other countries;
(II) Delivery free to destination in Italy for orders of € 300 (three hundred) for Italy or more;
(III) Ex-Works deliveries for other countries.

3.3 The prices given above do not include VAT and installation costs.

3.4 The prices provided in this catalogue shall be valid until a new price list is published.

4. Currency

All prices are given in Euros (exclusive of VAT). Invoices shall be drawn up in Euros.

5. Special requests

Products can be supplied to the Purchaser in non-standard colours and with special features. The relevant price, minimum quantities per order, methods and timing of deliveries shall be agreed in each individual case, in relation to the reference order.

6. Transport

6.1 Duralamp shall not be liable for any damage and/or losses which may occur during the transportation of the Products, unless the Products are delivered free at destination.

6.2 Duralamp shall have the right to establish the method of transportation to be used for the Products, unless the Parties have previously established a method of transport in writing.

6.3 Upon delivery, the Purchaser shall undertake to verify the condition of the products and shall make any complaints directly to the carrier and/or conduct any actions necessary in the event of loss, misplacement, removal or damage, or delays in transportation and/or the methods of delivery of the Products.

7. Complaints

7.1 In the event that the Products are found to have any faults and/or defects, the Purchaser shall undertake to notify Duralamp of the same in writing, by means of a registered letter, no later than 8 (eight) days following the discovery of the said faults and/or defects, at the risk of invalidating the obligations of the guarantee provided by Duralamp. In this case, the faulty Products, which should be reported within the terms established, should be returned to Duralamp, once the Purchaser has received specific permission to do so in writing.

7.2 In the event that the Purchaser's complaints are held to be valid, Duralamp, at its complete discretion, may make the necessary repairs and/or replace the Products, excluding the attribution of any further charges, obligations, indemnification or compensation to the same. The Products in question should be returned to the Duralamp S.p.A. plant in Via Pratese 164, 50145, Firenze, Italy. In the event that, following an inspection by Duralamp, the Products returned by the Purchaser are not found to be faulty and/or defective, Duralamp shall return the Products to the Purchaser, charging the same an amount equal to 15% (fifteen percent) of the value of the said Products.

8. Delivery

8.1 The Parties hereby agree that the terms established for the delivery of the Products shall not be considered absolute or essential and that, in any case, each item shall be exclusively in favor of Duralamp, unless otherwise agreed in writing between the Parties.

8.2 In the event of delayed delivery, once 15 (fifteen) days have passed since the agreed date, the Purchaser may send Duralamp written warning to complete the delivery within a further term of no more than 15 (fifteen) days from receipt of the same. In the event that Duralamp has not completed the delivery within this further term the Purchaser may withdraw from the order with regard to the Products that have not yet been delivered. In this case the Purchaser shall only be obliged to pay Duralamp for the Products actually delivered, excluding the payment of any further indemnification and/or compensation to the Purchaser.

8.3 Duralamp shall not be responsible for any other breaches, including the failure to deliver or delayed delivery of the Products, caused by events outside its reasonable control such as, purely by way of an example and not limited to the same: the failure to deliver or delayed delivery of manufacturing materials by Duralamp's suppliers, equipment breakdowns, strikes and other trade union action, electricity blackouts, suspension of or difficulties with transportation.

9. Payment

9.1 The price due shall be paid by the Purchaser according to the conditions and modalities set down in the order and, in any case, by means of payments made exclusively to "DURALAMP S.P.A."

9.2 Duralamp shall only recognize the validity of the payments when the same are made in compliance with the provisions of article 9.1 above. This means that amounts paid using any other method shall not be considered to be a payment in discharge of the Purchaser's obligations. The eventual acceptance by Duralamp of a bank draft or other trade bill shall only occur with the application of the proviso "under usual reserve".

9.3 In the event of delayed payment with respect to the terms agreed, the Parties hereby agree that bank interest shall be due to Duralamp at the current PRIME RATE increased by 3 points. Interest shall be applied as of right, with no obligation for Duralamp to send the Purchaser a formal notice to pay.

9.4 Moreover, in the event of a delay in payment of more than 15 (fifteen) days, Duralamp shall have the right to terminate the order as of right pursuant to article 1456 C.C., sending written notification of the same, barring compensation for any damage.

9.5 In the event that the Parties have agreed upon a method of payment by instalments for the Products, the failure to pay several instalments or just one instalment exceeding one eighth of the overall price of the Products, shall result in the loss of the Purchaser's right to pay in instalments and shall give Duralamp the right to request the remaining balance of the price or, alternatively, at its own discretion, to terminate the contract with immediate return of the Products and the acquisition of the instalments paid, as indemnification, barring the right to compensation for any damage sustained.

10. Guarantee

10.1 The Products provided by Duralamp shall be guaranteed for a period of 12 (twelve) months from the date of delivery against any manufacturing or material defects and/or faults and against any breakdowns not attributable to the Purchaser. Duralamp's only obligation and the Purchaser's right with regard to claims related to the guarantee shall be limited, as decided by Duralamp, to the replacement or repair of the defective or non-compliant product or the reimbursement of the price for the purchase of another product. Duralamp shall be granted a reasonable amount of time to repair or replace the product, or to make the previously authorized reimbursement. Any defective or non-compliant Products shall become the property of Duralamp as soon as they have been replaced or reimbursed.

10.2 The guarantee shall exclude any failures due to circumstances beyond the control of Duralamp (lightning, flooding, etc.), as well as any damage caused by the improper use of the Products and/or relevant accessories. Notwithstanding the above, Duralamp shall not be bound by the guarantee if the contested defects or non-compliances have occurred as a result of submitting the Products to resistance or environmental tests, the incorrect use of the same, or in the event that the use of or conditions of use of the Products is different from that indicated in the instructions and technical information, as a result of negligence, incorrect installation or accident, or if they derive from improper repairs, alterations, modifications, storage or transportation or by incorrect handling.

10.3 The Purchaser shall send the Products returned in accordance with the terms of the guarantee to the place indicated by Duralamp in compliance with the Duralamp policy regarding authorization to return materials in force at the time. In the event that the Products returned are found to be compliant or not faulty, the Purchaser shall pay the cost of returning the same as well as the cost of insuring, inspecting and handling the Products.

10.4 LED products Enjoy specific guarantees: details are published on www.duralamp.it

11. Limitation of Liability

11.1 WITH THE SOLE EXCLUSION OF CRIMINAL INTENT AND GROSS NEGLIGENCE, DURALAMP SHALL NOT BE LIABLE FOR LOSS OF PROFITS OR SAVINGS, LOSS OF REPUTATION OR GOODWILL, ANY DIRECT, INDIRECT, CONSEQUENTIAL OR SPECIAL DAMAGE THAT MAY DERIVE FROM OR BE CONNECTED TO THE CONTRACT OR SALE OF PRODUCTS OR SERVICES BY DURALAMP OR BY THE USE OF THE SAME OF A CONTRACTUAL OR EXTRA-CONTRACTUAL NATURE OR DERIVING FROM ANY OTHER SOURCE, EVEN WHERE DURALAMP HAS BEEN NOTIFIED OF OR IS AWARE OF THE POSSIBILITY OF SUCH DAMAGE.

11.2 The limitations and exclusions stated in article 11 shall apply within the limits permitted by law.

12. Applicable law and place of jurisdiction

12.1 These Conditions and all the effects of the same shall be governed by Italian law. The Parties hereby agree that any disputes related to these Conditions shall refer to Italian jurisdiction to the exclusion of all others.

12.2 The exclusive place of jurisdiction shall be the registered offices of Duralamp S.p.A., with the express exclusion of any other competing places of jurisdiction.



DURALAMP SPA Single member company
Registered office Via Pratese, 164 - 50145 Firenze
Tel. 055 894 881 - Fax 055 8953 032 / 055 8952 780
e-mail: duralamp@duralamp.it

Registered with the Florence Company Register -
C.F. and VAT number 03312240488
Registered with R.E.A. of Florence at n. 353287 Share capital € 400,000.00 i.v. -
Subject to the management and coordination of 3F FILIPPI S.P.A.



A complete list of the Duralamp distribution and
project network is available at:
www.duralamp.it

PROFESSIONAL LIGHTING

2020

Pricelist validity starting the 1st of May 2020

© Copyright 2020 - Duralamp SpA

All data and pictured provided in this catalogue are for reference only: since they might change during mass production, they have to be considered nominal values with tolerances. Duralamp Spa reserves the right to modify its products in any moment, for technical or commercial reasons.

Photos: Studio Artale - Studio Ceccanti - Alessandro Maurelli - Luca Visentini

Indoor or outdoor setting photos are used to illustrate the possible applications of the product.



May 2020
CAT_AP_2020-GB

3F Filippi

DURA
LAMP

duralamp.it